



OWNER'S MANUAL

CEILING MOUNT HEATER

5,000W / 240V



MODEL 1VAHG5000

TECHNICAL DATA

HARDWIRED INSTALLATION REQUIRED

This heater must be grounded and hardwired to a properly sized current protection circuit breaker in accordance with the (US) National Electric Code and local codes.

FEATURES:

- Adjustable Heat Settings
- Fan-Forced for Wide Heat Circulation
- Horizontal and Vertical Air Flow with Tilt Feature
- Sturdy Heavy Gauge Steel Body
- High-Limit Thermal Cut-Out Switch

1VAHG5000 HEAVY DUTY 5,000W ELECTRIC UTILITY HEATER

WATTS	SWITCH POSITION	VOLTS (VAC)	PHASE	AMPS	BTU/HOUR
5,000W	III	208-240V, 60Hz	1	20.8	17,060
4,000W	II	208-240V, 60Hz	1	16.7	13,650
3,000W	I	208-240V, 60Hz	1	12.5	10,240
Air Throw	Horizontal	18 Ft. (Approx.)			
Recommended	Circuit Breaker	30 Amp	or larger , in accordance with NEC and local codes.		
Recommended	Wire Size	10 AWG, Copper Only, Rated at 167°F / 75°C	or larger , hardwired in accordance with NEC and local codes.		
Recommended Lug Torques		35 In.-Lbs.	or greater , in accordance with NEC and local codes		
Product Weight (Approx.)		19.5 Lbs.			

WARNING: The installation of main power supply is highly recommended to be carried out by a certified electrician. The installation process involves working with electrical components, which can be dangerous and potentially life-threatening if handled incorrectly.

IMPORTANT NOTE:

Read the manual carefully. Make sure to save this manual for future reference. Illustrations in this manual are for explanatory purposes only, your actual product may look slightly different.

CONTENTS

Safety Guidelines	4-6
Operating Instructions	7
Power Indicator Light.....	7
Setting the Thermostat.....	7
Caution Light	7
Installing the Heater	8
Connecting the Power	9-10
Care and Maintenance	11

CONSUMER PRODUCT INFORMATION

For your own records, please attach a copy of your sales receipt to this manual. Also, write the store name/location and date purchased below:

Store Name: _____

Location: _____

Date Purchased: _____

SAFETY GUIDELINES

INTENDED USE:

Electric Utility heaters are designed to meet a variety of heating requirements. This product is intended for indoor use only. Use only with electrical wiring that is in good working order and that meets applicable codes and ordinances.

If you have any questions whether your wiring is adequate, consult a qualified electrician. Risk of fire, overheating, malfunction, property damage, injury or even death may result if not adhered to.

Use your heater-fan only with a working smoke detector located in the vicinity of your heater-fan.

While using your heater-fan, you should follow the IMPORTANT INSTRUCTIONS listed below. As part of those instructions, we have used the word "**WARNING**" to indicate the level of hazard: **WARNING** indicates a hazard which, if not avoided, could result in injury or death.

READ AND SAVE THESE INSTRUCTIONS

GENERAL SAFETY INFORMATION

WARNING - Read and understand installation and operation instructions and observe all safety instructions

1. For supply connections, use only copper wire, **See SPECIFICATIONS.**
2. Heater air flow must be directed parallel to, or away from adjacent wall.
3. Observe wall, floor, and ceiling clearance requirements, **See Figure. 1.**
4. All wiring must conform to national and local electrical codes in the United States and the heater must be grounded as a precaution against possible electrical shock. Heater circuit must be protected with proper fuses or circuit breakers.
5. The mounting structure and the anchoring hardware must be capable of reliably supporting the weight of the heater and, if used, the mounting bracket.
6. All electrical power must be disconnected, and the main service box must be locked before inspection, cleaning or servicing the heater. This is a precaution to prevent serious shock.
7. This heater is not suitable for use in hazardous locations as defined by the **National Fire Protection Association (NFPA)** in the United States. This heater has hot and arcing (sparking) parts inside. Do not use in areas where gasoline, paint, or flammable liquids are used or stored.

8. This heater is not suitable for use in corrosive atmosphere such as marine, greenhouses or chemical storage areas.
9. Do not install closer than 8 inches to a vertical surface. Do not install less than 6 feet from the floor.
10. Extreme caution is necessary when any heater is used by or near children or invalids and whenever the heater is left operating and unattended.
11. Use this heater only as described in this manual. Any other use not recommended by the manufacturer may cause fire, electric shock, or injury to persons.

WARNING - Improper installation or failure to follow the procedures outlined in this instruction manual can result in serious electrical shock.

WARNING: SHOCK HAZARD

Use your heater only in dry environments. This heater is not intended for use in a bathroom, laundry area, or similar locations, or near sinks, washing machines, swimming pools or other sources of water. Never locate heater where it may fall into a bathtub or other water container. Do not use heater outdoors. Do not use in damp environments such as flooded basements.

WARNING: HOT SURFACES

Do not touch body of heater when in use. This heater is hot when in use, to avoid burns, do not let bare skin touch hot surfaces. If provided, use handles when moving this heater.

WARNING: FIRE HAZARD

Heater has hot and arcing or sparking parts inside. Do not use near combustible materials or flammable gases or sources of heat. DO NOT USE in areas where gasoline, paint or flammable materials are used or stored. Keep combustible materials such as furniture, pillows, bedding, papers, clothes and curtains at least 3 feet (0.9 meters) from the front of the heater and keep them away from the sides and rear. To prevent a possible fire, do not block air intakes or exhaust in any manner. Do not use on soft surfaces, like a bed, where openings may become blocked. Do not insert or allow foreign objects to enter any ventilation or exhaust opening as this may cause an electric shock, fire, or damage the heater.

WARNING: ELECTRICAL SHOCK HAZARD

Do not use with damaged cord or plug. Use with adequate electrical system that is up to code. Do not operate any heater with a damaged cord or plug or after heater malfunctions, has been dropped or damaged in any manner. Do not operate heater with a broken heating element or ceramic cone or any visual imperfections.

PET OWNERS NOTE

The health of birds and some small pets are extremely sensitive to the fumes given off during the initial use of many appliances. Although these fumes are not harmful to humans, it is recommended that this heater not be used around birds and small pets during its initial use until the manufacturing corrosion coatings burn off.

INSTALLATION WARNING

FOR INDOOR USE ONLY, IN A DRY LOCATION FREE OF GASOLINE, PAINT, FLAMMABLE LIQUIDS OR COMBUSTIBLE DUST OR MATERIALS. DO NOT USE EXTENSION CORDS.

FIGURE 1

NOTE: Diagram is not drawn to scale; for information purposes only.
Product dimensions are approximate and subject to change without notice.

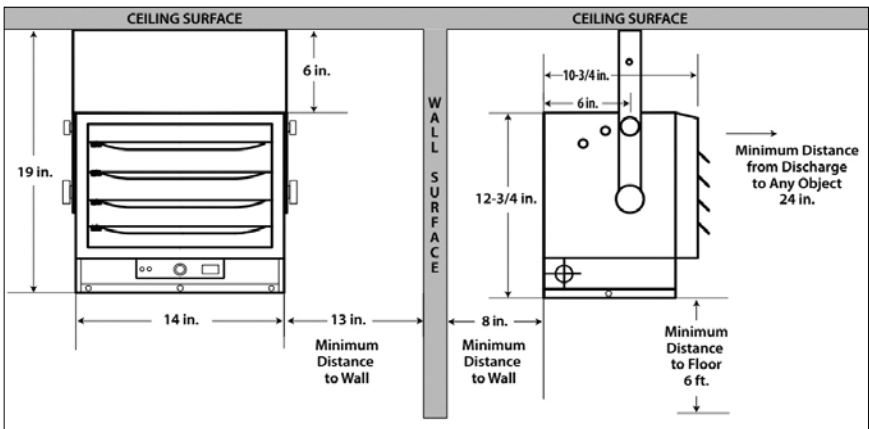

MAXIMUM MOUNTING HEIGHT USING BRACKET FOR HORIZONTAL/ANGLED AIR FLOW:

The maximum recommended ceiling height for effective vertical air flow is 8 ft.

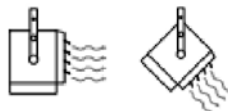

OPERATING INSTRUCTIONS

FIGURE 2

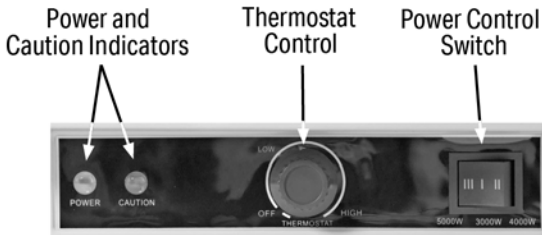

Control Panel Detail
(Enlarged for Clarity)

POWER INDICATOR LIGHT

Once installed and the breaker is turned ON, the YELLOW Power Indicator Light will glow. This light stays on as long as power is on at the breaker, even when the heater is off.

SETTING THE THERMOSTAT:

Press the TIMER Button continuously until the LED screen displays "0".

1. From "OFF" rotate the knob clockwise to a higher position.
2. Pick the desired power level (I, II or III) at the Control Switch.
3. Once the room reaches the desired comfort level, rotate the thermostat knob counter-clockwise until it clicks off. Heater will cycle on and off to maintain room temperature.

CAUTION LIGHT:

The heater has a **Thermal Cutout Switch**. If there is an overheat situation this switch will shut off the heater.

Once this happens the RED Caution Light will glow, indicating an overheat condition. Turn off the heater. Turn off power at the circuit breaker and let the heater cool down.

Determine the cause of the overheat situation and correct. Once cool, restore power to the heater at the breaker and resume operation of the heater.

NOTE: Heater will cycle on and off to maintain room temperature. The first time you operate the unit, it may smoke slightly. This is due to residual cleaning agents used to clean the element when the heater is manufactured. This is normal and does not indicate a problem with the unit. This condition will stop after the heater has been in operation for a few minutes.

INSTALLING THE HEATER

LOCATING THE HEATER

Install the heater out of traffic areas, maintaining the clearances stated in **Figure 1**. The air flow from the heater must not be restricted or obstructed by any items in the room. When more than one heater is used in an area, the heaters should be arranged so that the air discharge of each heater supports the air flow of the others to provide best circulation of warm air, as indicated below in **Figure 3**.

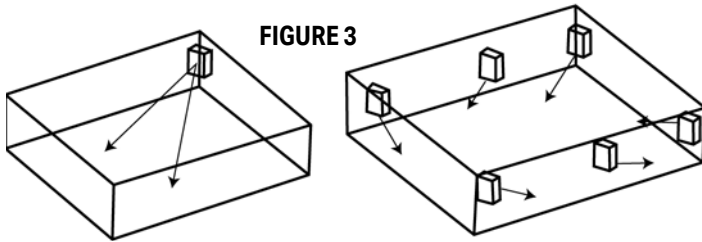

MOUNTING BRACKET INSTALLATION

Refer to **Figures 4a** and **4b**.

1. Locate a ceiling joist or other firm structural element or support to mount the heater and point at desired direction of air flow.
2. Drill a $\frac{1}{4}$ " pilot hole in the ceiling joist for the screws.
3. Place the screws and washers as shown in the **Figures 4a** or **4b**.
Fig. 4a: For Single-Screw Mounting (center bracket hole only). (If you want to swivel the heater, a longer Lag bolt may be required to properly secure the heater, not included.)
Fig. 4b: For Double-Screw Mounting (both off-center holes are used).
4. Tighten the screws to secure the heater.

FIGURE 4a: Single-screw mounting, to allow swivel

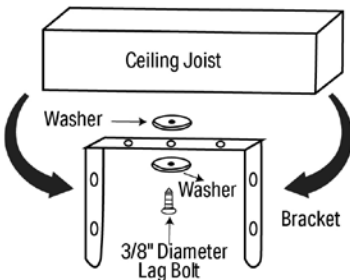
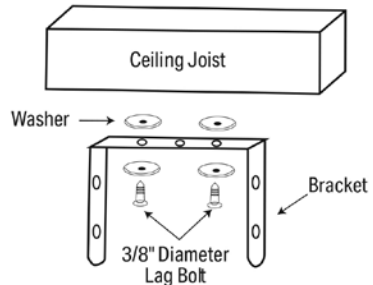

FIGURE 4b: Double-screw mounting, for fixed position



CONNECTING THE POWER

HANGING THE HEATER IN THE BRACKET

1. Lift the heater into the mounting bracket and align the lower bracket holes with the threaded holes nearest the heater's center.
2. Thread a large knob-screw through the hole on each side of the bracket.
3. Aim the heater horizontally or tilted by aligning the upper bracket holes with the top threaded holes on the heater and secure with the small knob-screws and tighten all. See **Figure 5**.

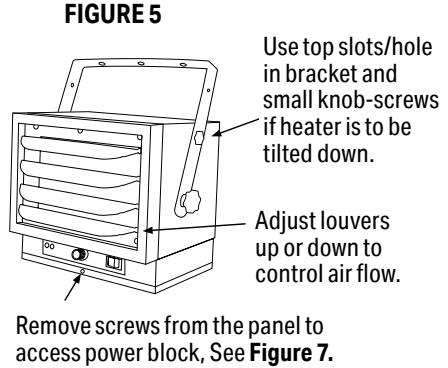

CONNECTING THE POWER:

WARNING: The installation of main power supply is highly recommended to be carried out by a certified electrician. The installation process involves working with electrical components, which can be dangerous and potentially life-threatening if handled incorrectly.

1. With the power off at the breaker, remove all screws from the bottom lid for access to the electrical section of the heater.
2. Attach flexible cable through a knock-out in the side of the heater following NEC and local codes, See **Figure 6** and **SPECIFICATIONS** for recommended wiring and circuit breakers.

NOTE: For certain applications, conduit may be required. See **Figure 6**. Check local electrical codes. If you run the wiring in conduit and wish to be able to turn the heater be sure to purchase enough flexible conduit to allow the heater to be turned.

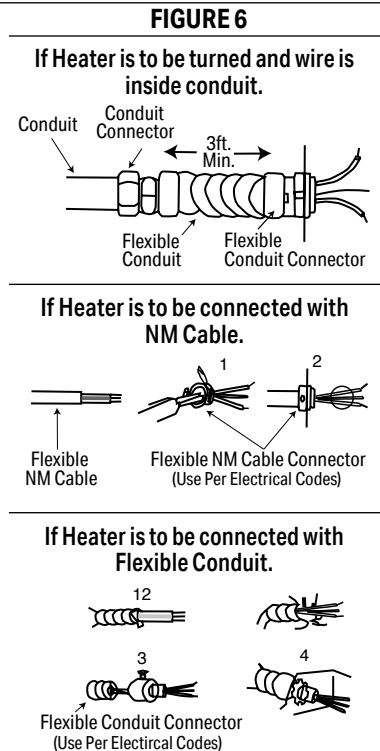

CONNECTING THE POWER *(Continued)*

3. Pull enough wire into the heater and connect to wire to the Power Block located in the electrical area of the heater. See **Figure 7**.
4. Be sure to torque all terminal screws and power block lugs tight, see **SPECIFICATIONS** and NEC/local codes, for required **torque values**, failure to do so can overheat the power blocks.
5. Turn on power at the main circuit breaker panel. Notice the **YELLOW** Power Indicator Light on the Control Panel will glow.

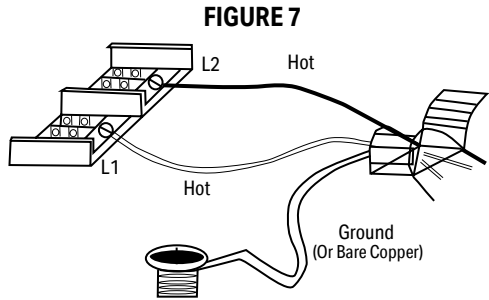

WARNING: It is advised that at the start of each heater season, the power should be turned off at the circuit breaker, and the L1 and L2 lug screws checked for tightness and **proper torque**. The heater should be cleaned and checked for mechanical and electrical integrity. See **SPECIFICATIONS** and NEC/local codes.

ADJUSTING AIR FLOW:

1. **Swivel the unit**—If mounted on a single center lag bolt **Figure 4a**, turn the entire heater and bracket assembly left or right.
2. **Tilt the unit**—Loosen the top Small Knob-Screws and thread into provided holes in heater until tight. See **Figure 5**.
3. **Adjust the louvers** in front of the heater as desired. See **Figure 5**.

NOTE: DO NO OPERATE THE HEATER WITH THE FRONT LOUVERS CLOSED, DAMAGE TO THE HEATER COULD RESULT.

SAFETY INSTRUCTIONS:

1. The heater is **HOT** when in use. Do not let bare skin touch any hot surfaces.
2. Keep combustible materials (furniture, pillows, bedding, papers, clothes, curtains, and similar items) at least 3 feet (0.9m) from all sides and surfaces of the heater.
3. Do not use outdoors or in wet areas like bathrooms, laundry areas or where it could fall into a swimming pool or other container of water.
4. This heater is a 240V AC rated direct wired appliance. Never use extension cords or relocatable power taps.

CARE AND MAINTENANCE

CLEANING THE HEATER

1. Do not disassemble the heater to clean it.
2. The heater should be powered OFF and disconnected from the power at the circuit breaker before attempting to clean any portion of the heater.
3. The exterior can be cleaned with a cloth, brush and/or vacuum.
4. The louvers, fan blade and heating element are delicate and should not encounter hard items. They can be cleaned by brush, vacuum and mild compressed air.

MAINTENANCE:

This Industrial Heater contains no user serviceable parts.



4560 W. 160th Street
Cleveland, OH 44135

833-950-1185 | support@visionairproducts.com
www.visionairproducts.com