



LOCKING GRAVITY LATCH WITH 2-SIDED KEY ENTRY

Installation Instructions

English.....	1
Français.....	7
Español.....	13



Read all instructions prior to installing product.
Refer to manufacturers safety instructions when operating any tools.

To register your product, please visit: barretteoutdoorliving.com

▲ WARNING:

- Improper installation of this product can result in personal injury. Always wear safety goggles when cutting, drilling and assembling the product.
- Incorrect installation may cause harm to the gate or individual.
- Not pool code approved.

NOTICE:

- DO NOT attempt to assemble the kit if parts are missing or damaged.
- DO NOT return the product to the store, for assistance or replacement parts call: 1-800-336-2383.

BEFORE YOU BEGIN:

Make sure your gate gap is between $\frac{3}{4}$ " and $1 \frac{1}{4}$ " before starting, this is the working gap range for this latch.

TOOLS NEEDED:

	Gate
	Safety Glasses
	Pencil
	Drill
	$\frac{1}{8}$ " Drill Bit
	$\frac{1}{2}$ " Drill Bit
	#2 Square Bit or Phillips Driver Bit/Screwdriver
	Hacksaw

Component list:

Item	QTY	Description
1	1	Outer Latch
2	1	Outer Bracket
3	1	Striker
4	1	Square Lock Rod
5	11	1" Phillips Screws
6	2	Keys
7	2	Outer Bracket Screws
8	1	Inner Bracket
9	1	Inner Latch Button

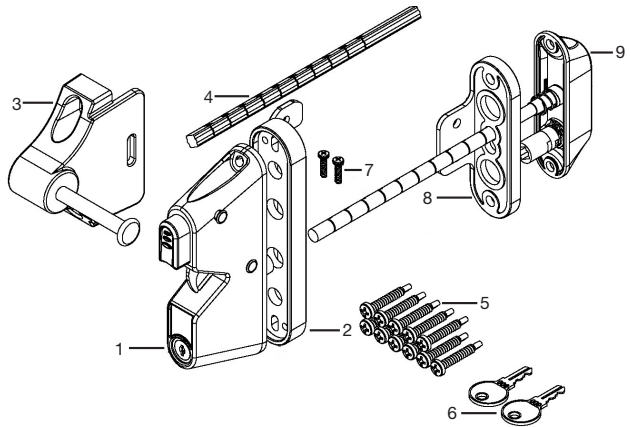

1.

Determine height of latch.

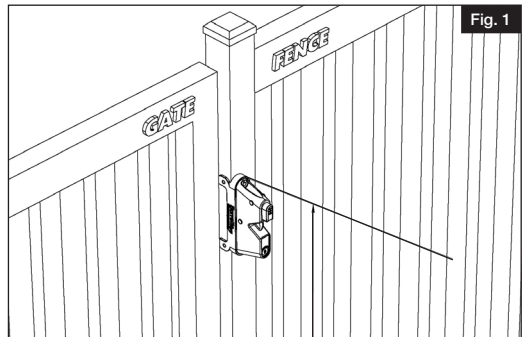

To obtain and review a copy of the warranty please visit: barretteoutdoorliving.com. You may also contact us at 1-800-336 2383 or email Cs.outdoorliving@ebarrette.com

2.

Hold up outer bracket and mark four holes on the front of post (Fig. 2) and two holes on the side of the post (Fig. 3). Mark mid line and using a square draw level line across post side (Fig. 3). For right-handed installation refer to Figures 4 and 5.

Left-Handed Installation:

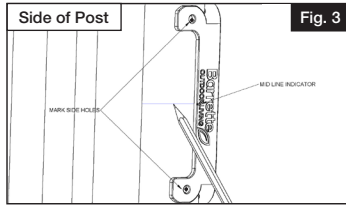
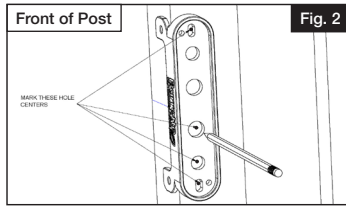

Right-Handed Installation:

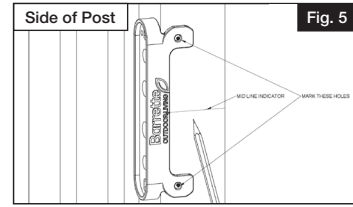
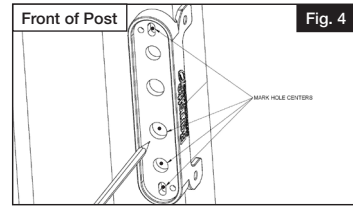

3.

Screw outer bracket to outer latch using small outer bracket screws (Fig. 6). Brackets are reversible and can go on either side of post depending on opening (Fig. 7).

Left-Handed Installation:

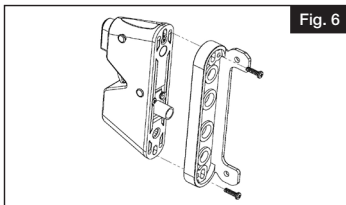

Right-Handed Installation:

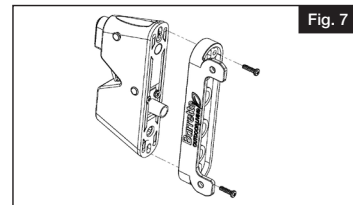

4.

Align inner bracket line with level line and mark two holes on the side (Fig. 8) and four holes on the back (Fig. 9). For right-handed installation refer to Figures 10 and 11.

Left-Handed Installation:

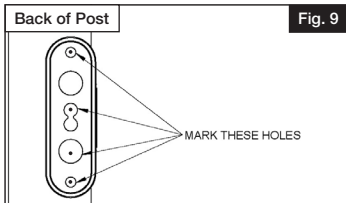
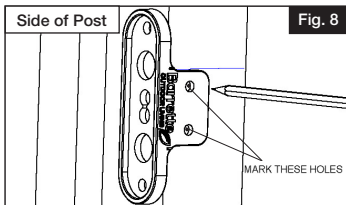

Right-Handed Installation:

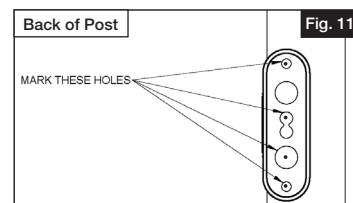
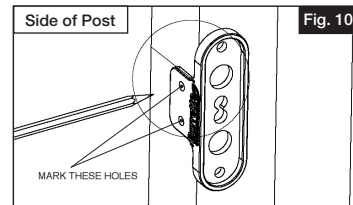

5.

Drill holes according to marks. See illustration for sizes (Fig. 12 and Fig.13). For right-handed installation refer to Figures 14 and 15.

Left-Handed Installation:

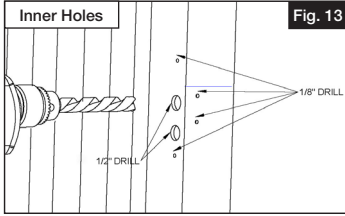
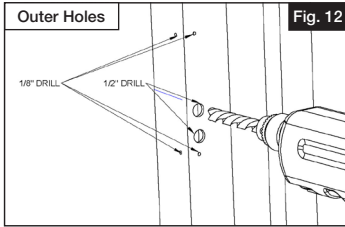

Right-Handed Installation:

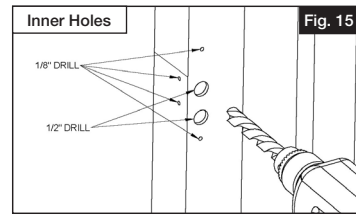
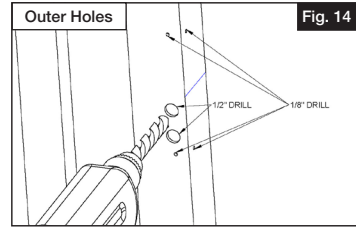

6.

Cut both plastic rods according to the post size (Fig.16). The lines next to the numbers correspond to the post size, see example (Fig. 17).

Example 1: If the post you are mounting the latch to is 2x2 cut on the 2.0 lines.

Example 2: If the post you are mounting the latch to is 5x5 cut on the 5.0 lines.

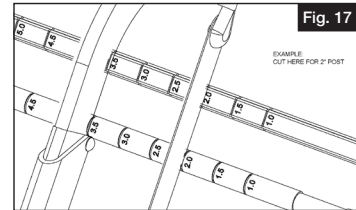
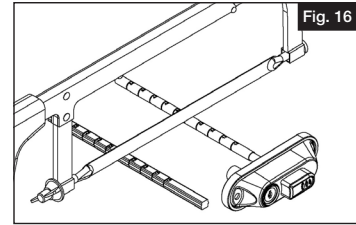

7.

First insert square lock rod into the inner latch as illustrated in Figure 18. Next install the inner latch with screws. Make sure rods are through the front of post as illustrated in Figure 19.

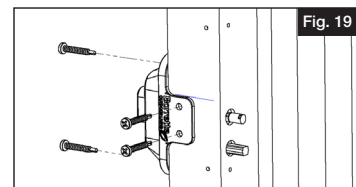
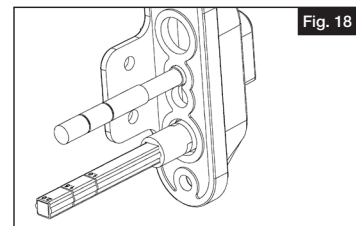

8.

Make sure the rods line up and fit into their mating holes in the outer latch and the latches sit flush (Fig. 20).

TIP: Insert keys into each side latch and test to make sure lock is working.

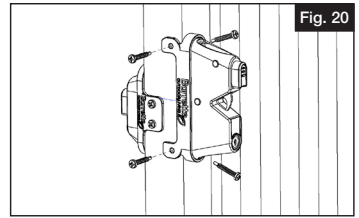

9.

Line up striker on gate and attach in middle of latch. Mark a line to indicate height (Fig. 21).

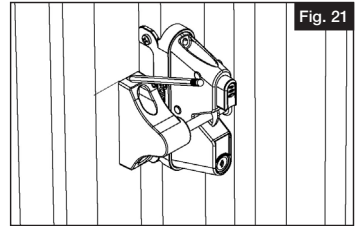

10.

Unlatch striker to open gate. Re-align striker with line and mark holes on front and side (Fig. 22).

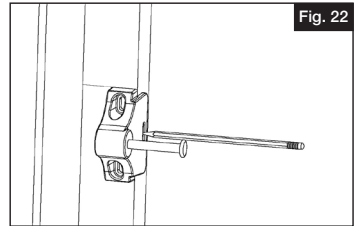

11.

Pre-drill with $\frac{1}{8}$ " drill and then install striker with screws (Fig. 23). Check alignment with latch and adjust striker height if needed.

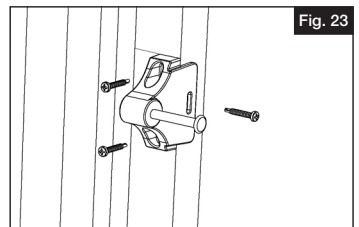



Barrette Outdoor Living
545 Tilton Rd, Egg Harbor City, NJ. 08215
barretteoutdoorliving.com • (800) 336-2383



LOQUET DE VERROUILLAGE PAR GRAVITÉ AVEC ENTRÉE DE CLÉ DES DEUX CÔTÉS

Instructions d'installation

English.....	1
Français.....	7
Español.....	13



Lire toutes les instructions avant d'installer le produit.
Consulter les consignes de sécurité du fabricant lors de l'utilisation des outils.

Pour enregistrer votre produit, veuillez visiter: **barretteoutdoorliving.com**

▲ AVERTISSEMENT:

- Une mauvaise installation du produit peut causer des blessures. Toujours porter des lunettes de sécurité lors de la coupe, du perçage et de l'assemblage du produit.
- Une installation incorrecte est susceptible de causer des dommages à la barrière ou des blessures aux personnes.
- Non approuvé par le code de la piscine.

AVIS:

- NE PAS tenter d'assembler le kit s'il y a des pièces manquantes ou endommagées.
- NE PAS retourner le produit au magasin. Pour obtenir de l'aide ou des pièces de remplacement, composer le 1-800-336-2383.

AVANT DE COMMENCER:

Avant de commencer, s'assurer que l'écart avec la barrière est de $\frac{3}{4}$ po à $1\text{-}\frac{1}{4}$ po (19 mm à 32 mm); c'est la plage d'écart recommandée pour ce loquet.

OUTILS NÉCESSAIRES:

Barrière
Lunettes de sécurité
Crayon
Perceuse
Foret $\frac{1}{8}$ po (3,2 mm)
Foret $\frac{1}{2}$ po (12 mm)
Embout carré no 2 ou embout Phillips
Scie à métaux

Liste de composants:

Item	QTY	Description
1	1	Loquet extérieur
2	1	Support extérieur
3	1	Gâche
4	1	Tige de verrouillage carrée
5	11	Vis Phillips 1 po (25 mm)
6	2	Clés
7	2	Vis de support extérieur
8	1	Support intérieur
9	1	Bouton de loquet intérieur

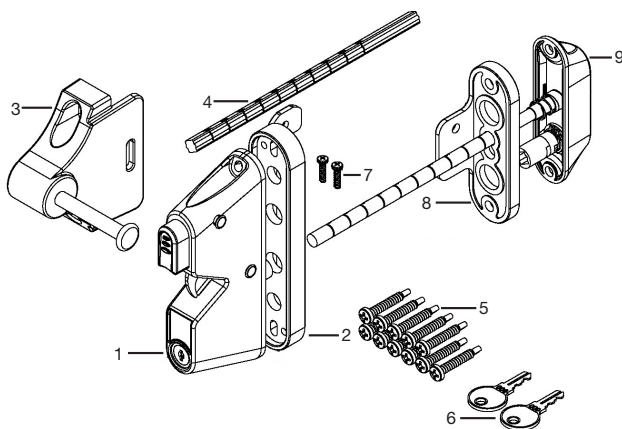

1.

Déterminer la hauteur du loquet.

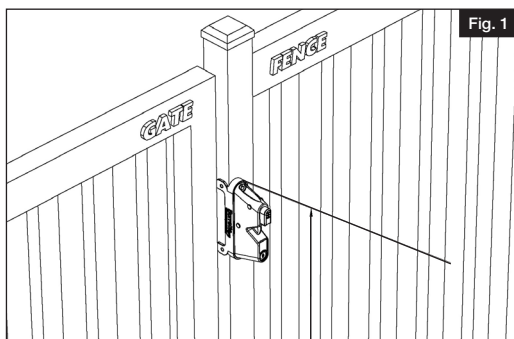

Pour obtenir et examiner une copie de la garantie, visiter: barretteoutdoorliving.com. Vous pouvez également nous appeler au 1-800-336 2383 ou nous envoyer un courriel à Cs.outdoorliving@ebarrette.com

2.

Tenir le support extérieur et marquer l'emplacement de quatre trous sur le devant du poteau (Fig. 2) et deux trous sur le côté du poteau (Fig. 3). Marquer une ligne médiane et, au moyen d'une équerre, tracer une ligne de niveau sur le côté du poteau (Fig. 3). Pour une installation à droite, voir Fig. 4 et Fig. 5.

Installation à gauche:

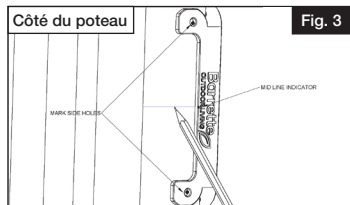
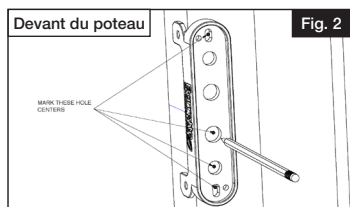

Installation à droite:

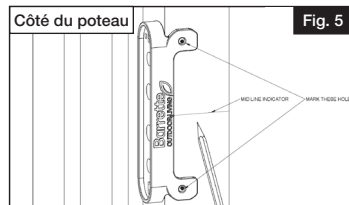
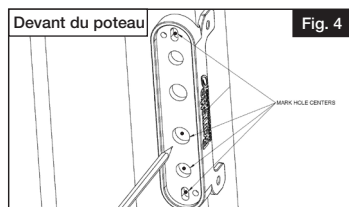

3.

Visser le support extérieur au loquet extérieur à l'aide de petites vis de support extérieur (Fig. 6). Les supports sont réversibles et peuvent être placés de chaque côté du poteau en fonction de l'ouverture (Fig. 7).

Installation à gauche:

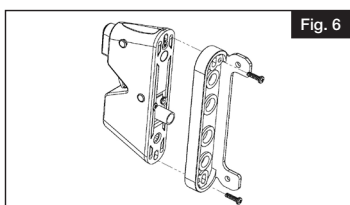

Installation à droite:

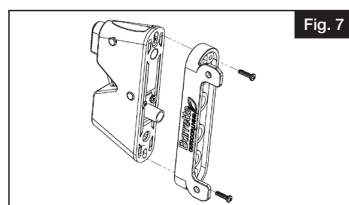

4.

Aligner la ligne du support intérieur sur la ligne de niveau, et marquer l'emplacement de deux trous sur le côté (Fig. 8) et de quatre trous à l'arrière (Fig. 9). Pour une installation à droite, voir Fig. 10 et Fig. 11.

Installation à gauche:

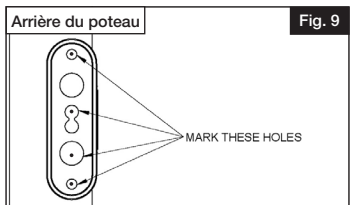
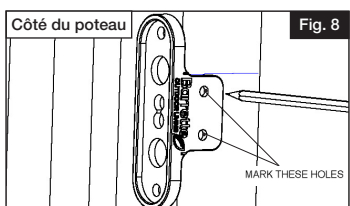

Installation à droite:

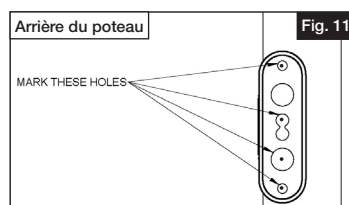
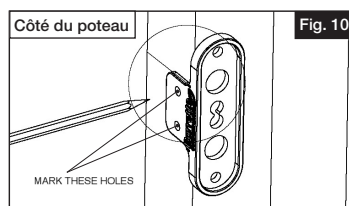

5.

Percer des trous aux emplacements des marques. Voir les dimensions dans Fig. 12 et Fig. 13. Pour une installation à droite, voir Fig. 14 et Fig. 15.

Installation à gauche:

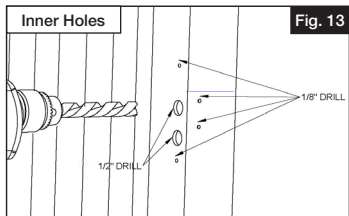
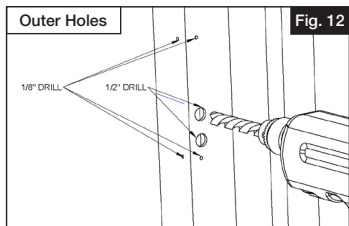

Installation à droite:

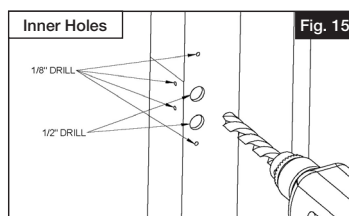
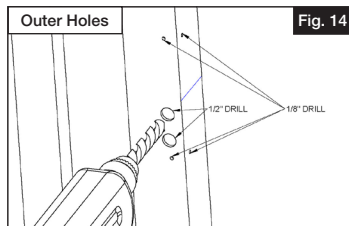

6.

Couper les deux tiges en plastique en fonction de la taille du poteau (Fig. 16). Les lignes à côté des chiffres correspondent à la taille du poteau (voir l'exemple dans Fig. 17).

Exemple 1: Si la taille du poteau sur lequel on installe le loquet est de 2 po x 2 po (50 mm x 50 mm), effectuer la coupe sur les lignes 2.0.

Exemple 2: Si la taille du poteau sur lequel on installe le loquet est de 5 po x 5 po (127 mm x 127 mm), effectuer la coupe sur les lignes 5.0.

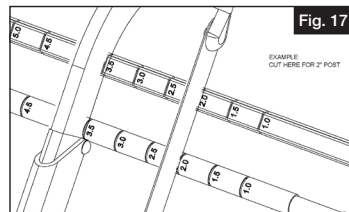
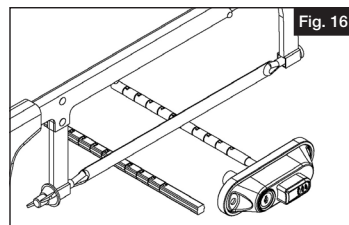

7.

D'abord, insérer une tige de verrouillage carrée dans le loquet intérieur comme le montre Fig. 18. Ensuite, installer le loquet intérieur à l'aide de vis. S'assurer que les tiges passent à travers l'avant du poteau comme le montre Fig. 19.

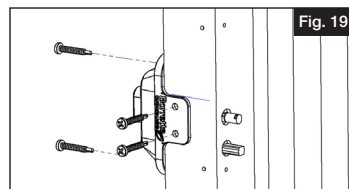
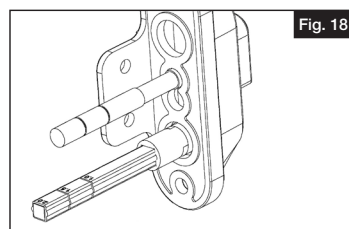

8.

S'assurer que les tiges sont alignées et s'insèrent dans leurs trous d'accouplement dans le loquet extérieur et que les loquets sont à fleur (Fig. 20).

CONSEIL: Insérer les clés dans chaque loquet latéral et vérifier que la serrure fonctionne.

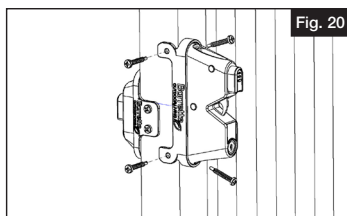

9.

Aligner la gâche sur la barrière, et fixer la gâche au milieu du loquet. Tracer une ligne pour indiquer la hauteur (Fig. 21).

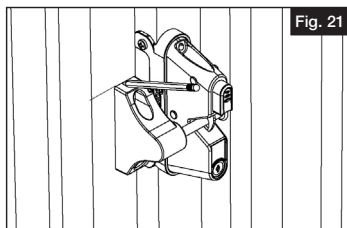

10.

Déverrouiller la gâche pour ouvrir la barrière. Réaligner la gâche sur la ligne et marquer l'emplacement des trous à l'avant et sur le côté (Fig. 22).

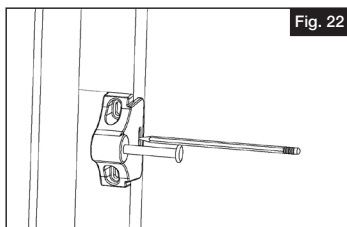

11.

Percer des avant-trous au moyen d'un foret de $\frac{1}{8}$ po (3,2 mm), puis fixer la gâche à l'aide de vis (Fig. 23). Vérifier l'alignement avec le loquet, et ajuster la hauteur de la gâche au besoin.

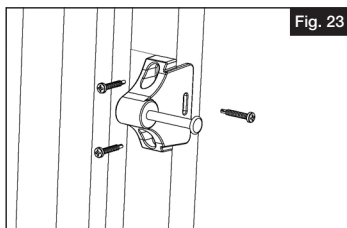



Barrette Outdoor Living
545 Tilton Rd, Egg Harbor City, NJ. 08215
barretteoutdoorliving.com • (800) 336-2383



CERROJO POR GRAVEDAD CON ACCESO MEDIANTE LLAVE POR LOS DOS LADOS

Instrucciones de instalación

English.....	1
Français.....	7
Español.....	13



Lea todas las instrucciones antes de instalar el producto.
Consulte las instrucciones de seguridad del fabricante al utilizar herramientas

Para registrar su producto, visite: barretteoutdoorliving.com

▲ ADVERTENCIA:

- La instalación incorrecta de este producto puede resultar en lesiones corporales. Utilice siempre gafas de seguridad al momento de cortar, taladrar y ensamblar el producto.
- La instalación incorrecta puede causar daños al portón o a personas.
- Código de piscina no aprobado.

AVISO:

- NO intentar ensamblar el kit si faltan piezas o las piezas están dañadas.
- NO devolver el producto a la tienda; para solicitar ayuda o piezas de repuesto, llame al: 1-800-336-2383.

ANTES DE COMENZAR:

Asegúrese de que el portón tenga una separación de entre $\frac{3}{4}$ " y $1\text{-}\frac{1}{4}$ " antes de empezar; este es el rango de separación que funciona para este cerrojo.

HERRAMIENTAS QUE SE REQUIEREN:

Portón
Gafas de protección
Lápiz
Taladro
Broca de $\frac{1}{8}$ "
Broca de $\frac{1}{2}$ "
Punta de desarmador cuadrado #2/punta Phillips o desarmador
Segueta

Liste de composants:

Item	QTY	Description
1	1	Cerrojo exterior
2	1	Soporte exterior
3	1	Traba
4	1	Barra de bloqueo cuadrada
5	11	Tornillos Phillips de 1"
6	2	Llaves
7	2	Tornillos para soporte exterior
8	1	Soporte interior
9	1	Botón de cerrojo interior

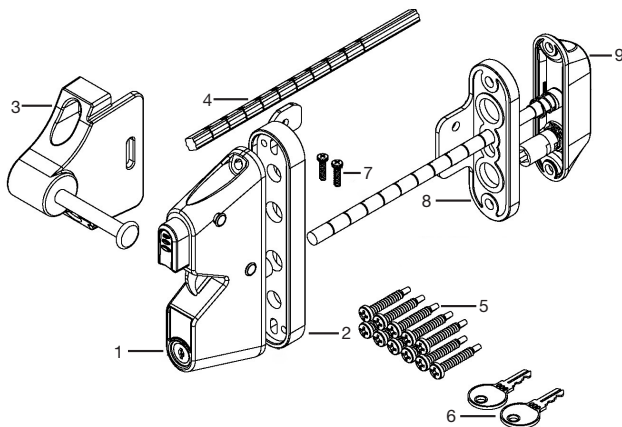

1.

Determine la altura del cerrojo.

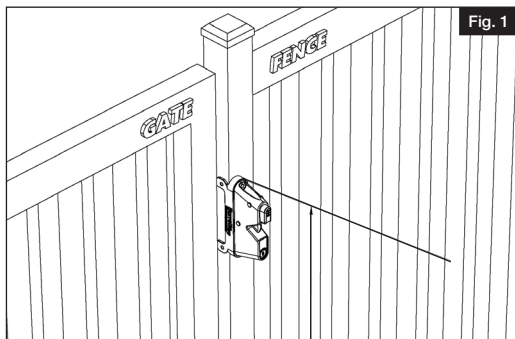

Para obtener y revisar una copia de la garantía, visite: barretteoutdoorliving.com. También puede contactarnos en: 1-800-336 2383 o correo electrónico Cs.outdoorliving@ebarrette.com

2.

Sostenga el soporte exterior y marque cuatro agujeros en la cara anterior del poste (Fig. 2) y dos agujeros en la cara lateral del poste (Fig. 3). Marque la línea central y, con una escuadra, trace una línea nivelada en el lado del poste (Fig. 3). Para la instalación en el lado derecho, consulte las figuras 4 y 5.

Instalación en el lado izquierdo:

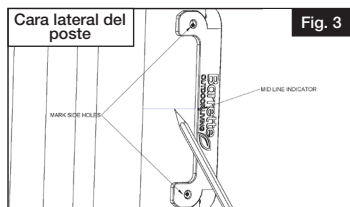
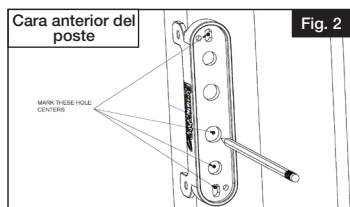

Instalación en el lado derecho:

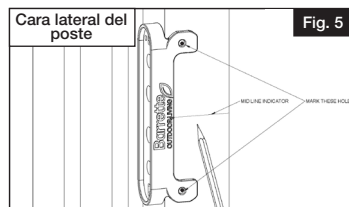
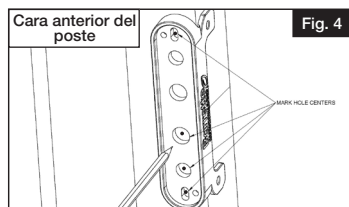

3.

Atornille el soporte exterior al cerrojo exterior con los tornillos pequeños del soporte exterior (Fig. 6). Los soportes son reversibles y pueden ir en ambos lados del poste según la apertura (Fig. 7).

Instalación en el lado izquierdo:

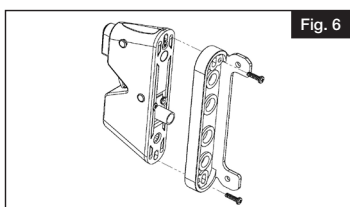

Instalación en el lado derecho:

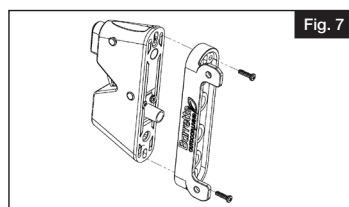

4.

Alinee la línea del soporte interior con la línea nivelada y marque dos agujeros en la cara lateral (Fig. 8) y cuatro agujeros en la cara posterior (Fig. 9). Para la instalación en el lado derecho, consulte las figuras 10 y 11.

Instalación en el lado izquierdo:

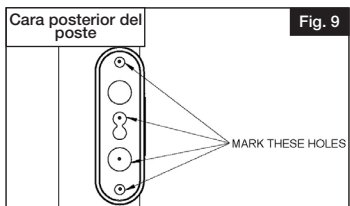
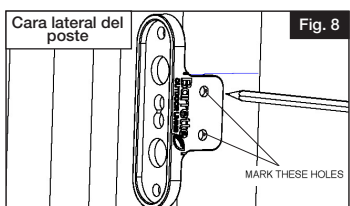

Instalación en el lado derecho:

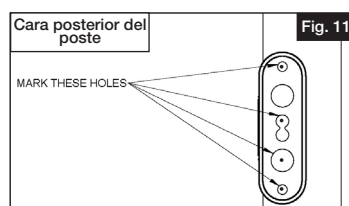
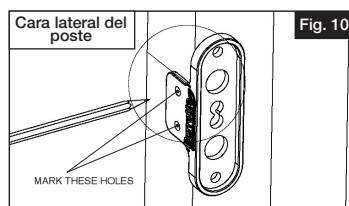

5.

Taladre los agujeros según las marcas. Véase la ilustración para conocer los tamaños (Fig. 12 y Fig. 13). Para la instalación en el lado derecho, consulte las figuras 14 y 15.

Instalación en el lado izquierdo:

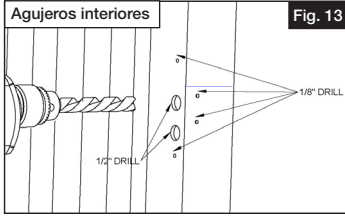
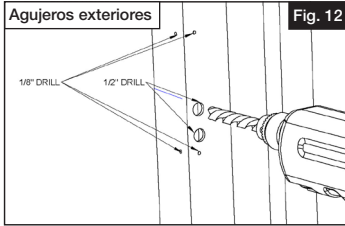

Instalación en el lado derecho:

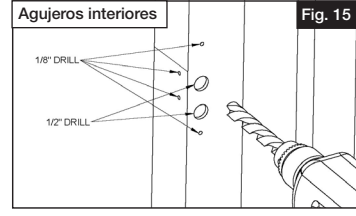
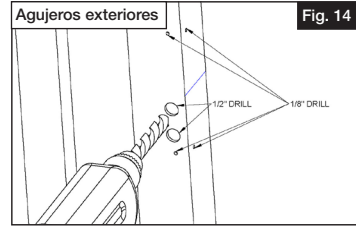

6.

Corte las dos varillas de plástico según el tamaño del poste (Fig. 16). Las líneas junto a los números corresponden al tamaño del poste, véase el ejemplo (Fig. 17).

Ejemplo #1: Si el poste en el que se va a montar el cerrojo es de 2x2, corte en las líneas de 2.0.

Ejemplo #2: Si el poste en el que se va a montar el cerrojo es de 5x5, corte en las líneas de 5.0.

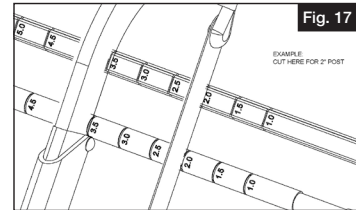
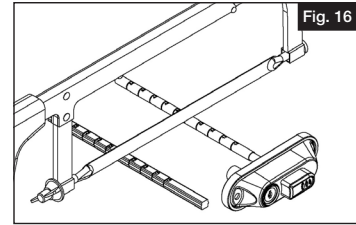

7.

En primer lugar, inserte la barra de bloqueo cuadrada en el cerrojo interior, como se muestra en la figura 18. A continuación, instale el cerrojo interior con tornillos. Asegúrese de que las barras pasen por la parte delantera del poste, como se muestra en la figura 19.

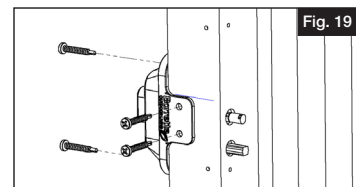
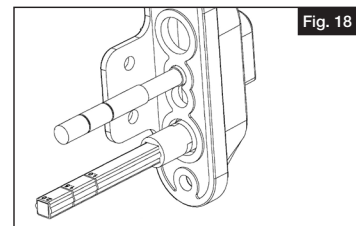

8.

Asegúrese de que las barras se alinean y encajan en sus agujeros de acople en el cerrojo exterior y que los cerrojos se asientan a ras (Fig. 20).

SUGERENCIA: Introduzca las llaves en ambos cerrojos y compruebe que la cerradura funciona.

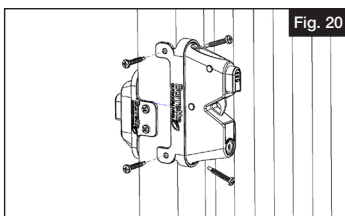

9.

Alinee la traba en el portón y fjela en la parte central del cerrojo. Marque una línea para indicar la altura (Fig. 21).

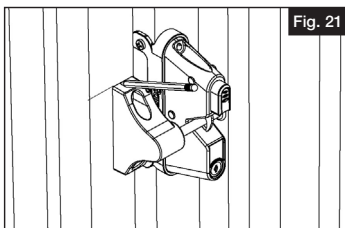

10.

Desbloquee el cerrojo para abrir el portón. Vuelva a alinear la traba con la línea y marque los agujeros en la cara anterior y lateral (Fig. 22).

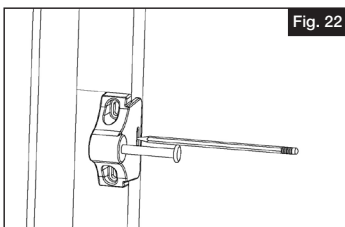

11.

Taladre agujeros con una broca de 1/8" y luego instale la traba con los tornillos (Fig. 23). Compruebe la alineación con el cerrojo y ajuste la altura de la traba, si es necesario.

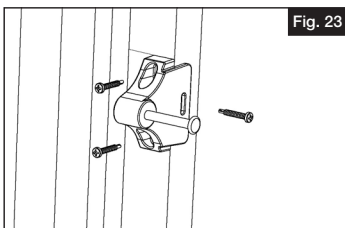



Barrette Outdoor Living
545 Tilton Rd, Egg Harbor City, NJ. 08215
barretteoutdoorliving.com • (800) 336-2383