

eWagon W1 Pro

Model No.: U20HW01-0A111

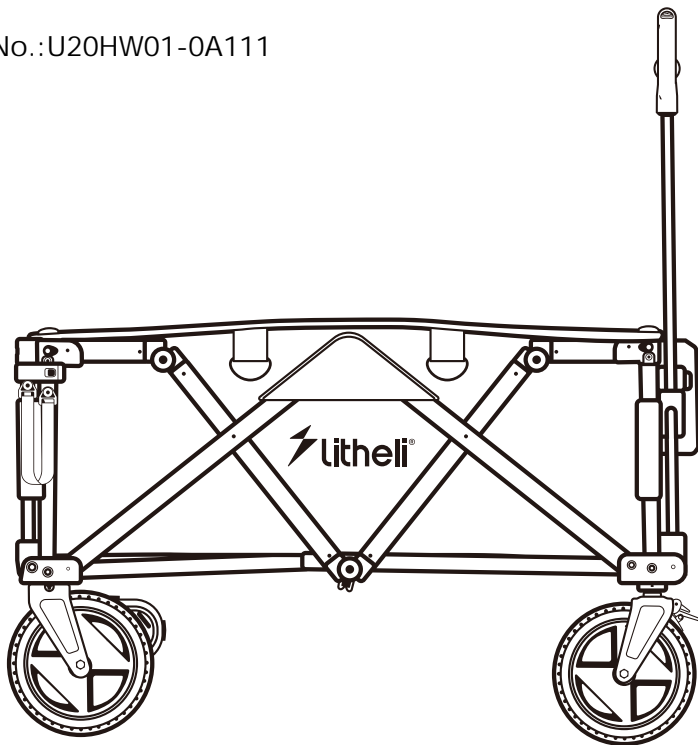

Thank you for choosing Litheli's Electric Wagon W1 Pro. Please read this manual carefully before use and keep it for future reference.

TABLE OF CONTENTS

Packing List -----	02
Important Safety Instructions -----	03
Quick Start Guide -----	04
Operation -----	06
Technical Data -----	10
Maintenance -----	10
Warranty -----	11

Packing List

- This product has a variety of configurations for sale, please check the corresponding configuration according to the product model you purchased.
- Please make sure to carefully inspect the product packaging to ensure that the product and accessories have not been damaged or lost during transportation.
- If you find that the product or accessories have been damaged or missing, please contact the manufacturer or authorized repair center immediately for repair or replacement.

U20HW01-0A011

① ②

U20HW01-0A111

① ② ③ ④

U20HW01-0A211

① ② ③ x2 ④

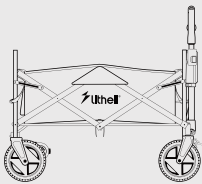

① Wagon + Liner



② Tie-down Strap



③ U Battery Plus



④ Charging Cable

Important Safety Instructions

1. This product must be operated by adults, please do not let children and elderly people who have difficulty in movement install and use this product.
2. Do not allow children to play with this product as a toy, children must be accompanied by adults to use this product.
3. Please make sure the product is fully opened before placing objects.
4. This product is recommended to bear a weight within 60kg, please try to evenly distribute the placement of items in the car.
5. Overload or incorrect folding and the use of non-approved parts may cause damage to the product failure or unsafe, please be sure to use the officially approved parts and follow the instructions for the correct use of the product.
6. To avoid finger pinching, please be careful when closing and unfolding the product.
7. When adjusting any movable parts on this product, please make sure that your fingers and other limbs are at a safe distance from the adjustable parts.
8. Do not use this product on the stairs.
9. Please keep away from fire, high temperature, pool or power sources to maintain a safe range when using.
10. Do not place children on the wagon.
11. Do not place this product on roads, ramps, or dangerous places.
12. When you find that the product is damaged, you should immediately stop using it and contact the querulous after-sales service for consultation.
13. To ensure the safety of use, please adjust the speed of the product carefully, do not set the speed to too fast or use the product when running.
14. Do not use the wagon in bad weather conditions, especially when there is a risk of lightning. This decreases the risk of being struck by lightning.
15. Inspect pathway before hauling objects / materials. Familiarizing yourself with the pathway and ensuring it is wide enough to safely navigate the wagon under load will help reduce losing control of the wagon.
16. Use extreme caution on slippery, loose, and unstable terrain. Wet and slippery surfaces. Such as wet grassy areas, snow or ice, and loose and unstable terrain, such as sand or gravel surfaces, may cause the wagon to lose traction and may adversely affect steering, braking, and stability.
17. Do not operate the wagon on excessively steep slopes. This reduces the risk of loss of control, slipping, and falling which may result in personal injury. Slopes greater than the maximum recommended grade (10°) may increase the risk of instability and may adversely affect the ability to stop safely.

18. When working on slopes, always be sure of your footing, always work across the face of slopes, never up or down, and exercise extreme caution when changing direction. This reduces the risk of loss of control, slipping, and falling which may increase the risk of personal injury.
19. Whenever possible, use level areas for stopping, loading, and unloading and never leave the wagon unattended on a slope. The wagon is more unstable when resting on a slope than when resting on a level surface.
20. When stopping on slopes, face the wagon uphill or downhill and block unbraked wheels. The wagon is less stable when facing across a slope, Unbraked wheels, especially those of the castor-type, can potentially turn and roll downhill even while the front wheel parking brake is set.
21. When leaving the wagon unattended, set the parking brake once the wagon is located in a safe stopping area. The parking brake prevents unwanted movement of the front wheel and can improve stability.
22. Ensure all locking screws are tightly secure before using. Locking screws on the wheels and open-type carrier front and side walls must be secure to prevent unwanted movement of these adjustable parts of the wagon.

Quick Start Guide

【Expand & Collapse】

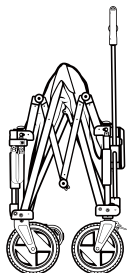

**Take folded wagon out of box
And place on a flat surface.**

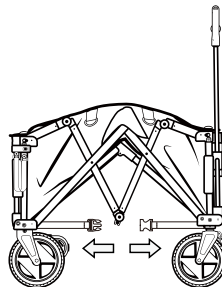

**Open the buckle on the
fastening strap underneath
the wagon.**

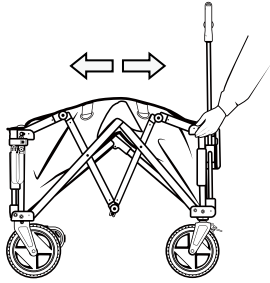

Unfold your wagon by pulling either side opposite ways as shown.

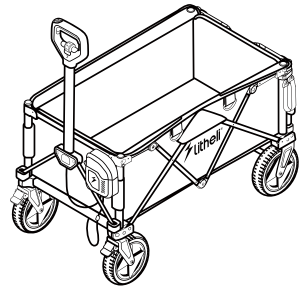

Attach the wagon liner using the velcro flaps.

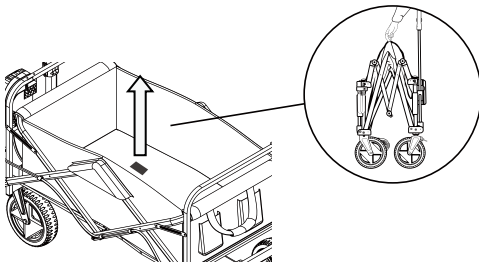

Lightly lift the middle pull to fold and store the wagon.

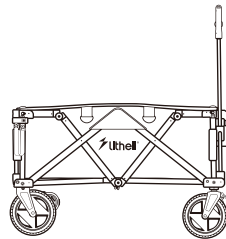

【Non-electric Mode】 Start using.

Operation

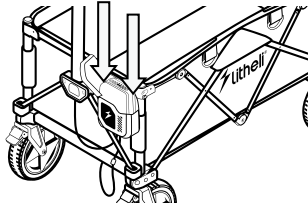

Install the Battery:

Open the battery compartment.

Insert the battery (with power button facing up) and the battery start key.

NOTICE: - The electric mode cannot be started when the battery start key is not inserted.
- The U-Battery Plus can also be used as a power bank.
- For more information on battery usage and safety precautions, please refer to the U-Battery Plus manual.

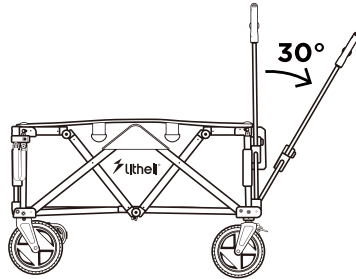
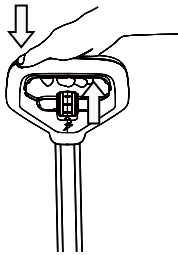

Start/Stop:

Press the self-lock button, then the start button, and tilt the handle forward 30° to start the wagon.

NOTICE: The wagon cannot be started by pressing only the self-lock button or the start button, or if the handle angle is $\leq 30^\circ$. After the wagon is started, you may release the self-lock button, but ensure that the handle angle remains $> 30^\circ$, otherwise the wagon will stop running.

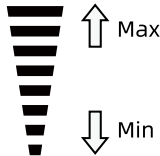
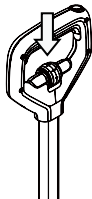

It is recommended to adjust the speed to the lowest level before use.

Speed Adjustment:

You can adjust the speed of the electric drive of the wagon according to the demand.

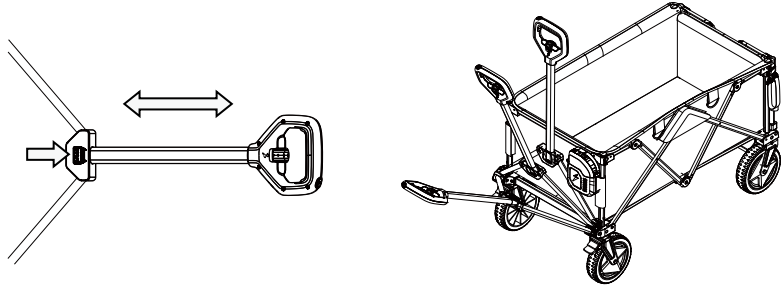

Handle Adjustment (Height + Angle):

-- Press the 'PRESS' button on the handle, adjust the handle to the appropriate height, and release the button lock the height.

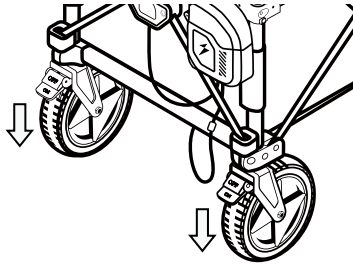

Braking:

Press the "LOCK" pedal firmly to lock the wheel, and lightly press the "UNLOCK" pedal to unlock it.

NOTICE: Do not use the brake on the ground with a slope >5°.

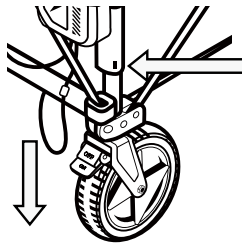

Quick-release Wheel:

The wheels can be easily removed by pressing the yellow button on the frame above the wheels for easy storage.

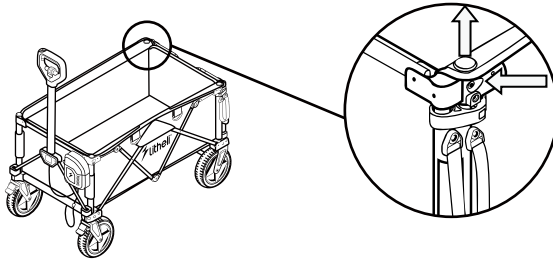

Bag Disassembly:

Press the locking pin, remove the corner pin located at the four corners of the wagon. Open the Velcro near the tailgate and under the wagon to remove the liner.

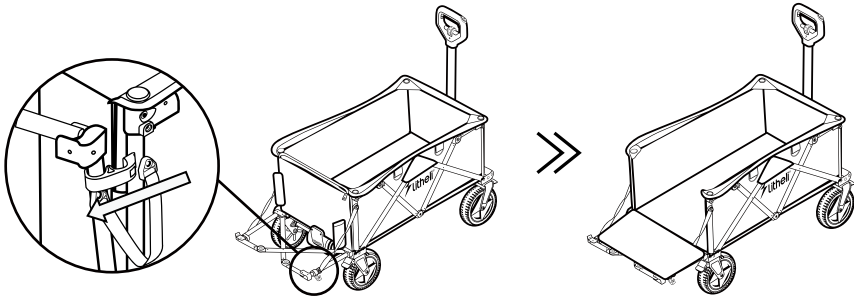

Tailgate Opening and Closing:

Open the latches on both sides and pull the zipper on both sides of the wagon liner, to lower the door.

To close the door, remember to snap the latch and zip up the zipper to lock it.

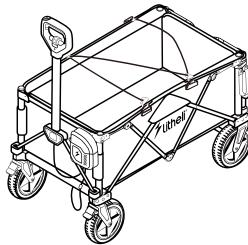

Four-hook Tie-down Strap:

This accessory is used to secure cargo on the wagon.

To use the strap, attach the hooks to the rings on both sides of the wagon and adjust the length as needed. Be sure to tighten the straps securely to prevent cargo from shifting during transport.

Accessory Table Assembly:

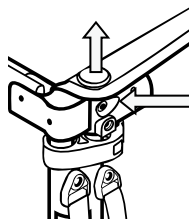

Press the locking pin to remove all the existing corner pins and replace them with bullhorn buckle-equipped corner pins.

To insert the corner pin:

Align the locking pin on the corner pin with the hole in the wagon frame, insert the pin and press down firmly until the locking pin pops out from the hole.

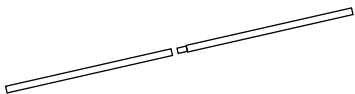

Connect the bracket pole.

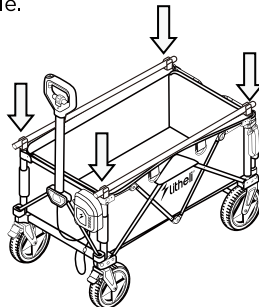

Mount the bracket pole onto the bullhorn buckle to fix it.

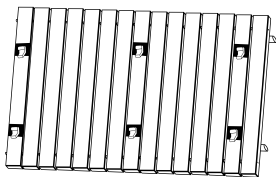

Adjust the bullhorn buckle behind the accessory table board to the appropriate position.

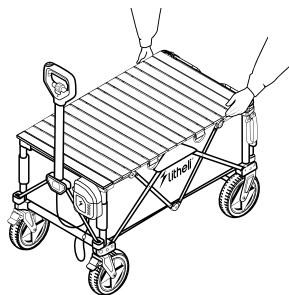

Install the accessory table board onto the bracket pole.

Technical Data

Battery capacity	74Wh(20000mAh)
Voltage	20V(Max)
Motor Type	Brushed Motor
Speed Control Method	Variable Speed Control
Speed Control Method	0.6-1.3m/s ±0.1m/s(asphalt road)
Comprehensive Operating Time	30min
Volume	140L
Unfolded Size	40.2" *27.7" *23.6"/42.1" with handle (1020mm*550mm*600mm/1070mm with handle)
Storage Size	25.2" *12.6" *30.9" (640mm*320mm*785mm)
Weight	33.5lb(15.2kg)
Load	132.3lb(60kg)
Wheel Size	8"
Maximum Slope	10°
Brake Type	Foot Brake
Handle Adjustable Height	13.78"(350mm)

Maintenance

1. When cleaning the wagon liner, please use warm water below 30° to wash by hand, please do not bleach.
2. When cleaning the frame, please use a soft dry rag to wipe it.
3. This product should be stored in a dry, ventilated area where it is not exposed to direct sunlight. It is best to store it indoors or in a covered area to avoid damage to the wagon from rain or other weather elements.
4. Do not store this product near flammable or hazardous materials to avoid fire or contamination.

5. Before storage, it is recommended to thoroughly clean this product, especially the wheels, frame and cloth pockets and other parts. In addition, a proper rust prevention treatment can be applied to the metal surface to ensure that the wagon is always in good condition during storage.
6. Before storing this product, please check if all the parts have been fixed, such as screws, wheels, etc., to ensure that they are in a stable and safe condition.
7. When not in use for a long time, it is recommended to remove the battery and store it in a safe, dry and ventilated place and charge and discharge it every three months. This can avoid battery life loss due to prolonged idleness in the absence of power, and also reduce potential risks such as internal corrosion of the battery.

*For more battery-related maintenance regulations, please refer to the relevant section of the U-core Plus manual.

Warranty

Litheli WARRANTY POLICY FOR U20 PRODUCT

- For Litheli U20 product (battery excluded) used for personal and household purposes,
1-year limited warranty;
- For Litheli U20 batteries used for personal and household purposes, 1-year limited warranty;

Please contact Litheli customer service at service@litheli.com any time you have questions or warranty claims.

LIMITED WARRANTY SERVICE

FOR ONE YEAR from the date of original retail purchase, this Litheli product (battery not included) is warranted against defects in material or workmanship. Defective product will receive free repair or will be exchanged.

FOR ONE YEAR from the date of original retail purchase, the Litheli battery is warranted against defects in material or workmanship. Defective product will receive free repair or be exchanged.

1. This warranty only covers Litheli products and batteries used for residential purposes.
2. This warranty does not cover the consumables such as, but not limited to, charging cable.
3. This warranty does not cover the damage resulting from modification, alteration or unauthorized repair.
4. This warranty only covers defects arising under normal usage and does not cover any malfunction, failure or defect resulting from misuse, abuse (including overloading of the product beyond capacity and immersion in water or other liquid), accidents, neglect or lack of proper installation, and improper maintenance or storage.
5. This warranty does not cover normal deterioration of the exterior finish including but not limited to scratches, dents, paint chips, or to any corrosion or discoloring by heat, abrasive and chemical cleaners.
6. This warranty applies only to the original purchaser from an authorized Litheli shop and may not be transferred.
7. This warranty does not require Litheli to repair or replace a Litheli lithium-ion battery/ies if the battery/ies present/s shortened runtime/working hour, reduced capacity, and/or weakened performance due to normal chemical age.

WARRANTY CLAIM

For warranty claims, please contact Litheli customer service. You will need to submit a registration document or proof of purchase in the form of a valid receipt that displays date and place of purchase. Replacement products do not come with a new warranty. The warranty of the products will continue from the date of the original purchase.

litheli tool

TOOLS FOR THE FUTURE