

CORDLESS POLE SAW

SKU No. U20PS00-0A110

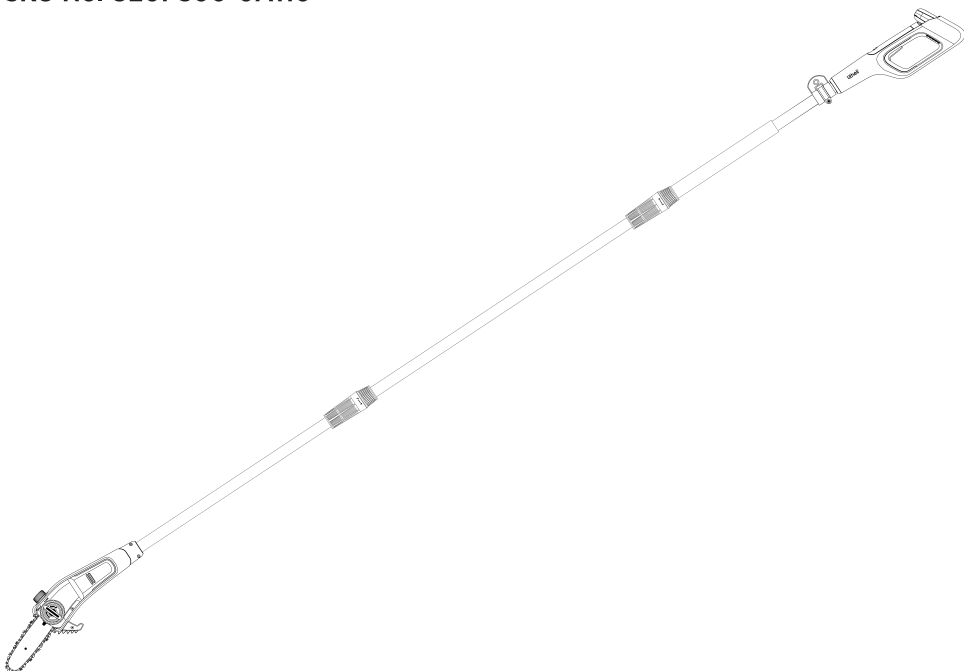

WARNING:

To reduce the risk of injury, the user must read and understand the user manual before using this product. Save this manual for future reference.

TABLE OF CONTENTS

Important Safety Instructions	02
Safety Symbols	09
Know Your Tool	12
Charging Your Battery	15
Assembly	15
Operation	25
Maintenance	31
Storage	35
Troubleshooting	36
Warranty	38

READ ALL INSTRUCTIONS!



WARNING: Some dust created by power sanding, sawing, grinding, drilling and other construction activities contains chemicals known to the state of California to cause cancer, birth defects or other reproductive harm. Some examples of these chemicals are:

- Lead from lead-based paints,
- Crystalline silica from bricks and cement and other masonry products, and
- Arsenic and chromium from chemically-treated lumber.

Your risk from these exposures varies, depending on how often you do this type of work. To reduce your exposure to these chemicals: work in a well-ventilated area, and work with approved safety equipment, such as those dust masks that are specially designed to filter out microscopic particles.

IMPORTANT SAFETY INSTRUCTIONS



WARNING:
Only use the accessories that are provided with this product or the accessories approved by Litheli. Use other accessories might increase the risk of injury. Follow the instructions in this manual to properly use the accessories.



WARNING:
This product can expose you to chemicals including lead and Di(2-ethylhexyl) phthalate (DEHP) which are known to the State of California to cause cancer and birth defects or other reproductive harm. For more information go to www.P65Warnings.ca.gov.

GENERAL POWER TOOL SAFETY WARNINGS



WARNING:
Read all safety warnings and instructions. Failure to follow the warnings and instructions may result in electric shock, fire and/or serious injury.

Save all warnings and instructions for future reference.

1. WORK AREA SAFETY

- a. **Keep the work area clean and well-lit.** Cluttered or dark areas invite accidents.
- b. **Do not operate power tools in explosive atmospheres, such as in the presence of flammable liquids, gases or dust.** Power tools create sparks that may ignite the dust or fumes.
- c. **Keep children and bystanders away while operating a power tool.** Distractions can cause you to lose control.

2. ELECTRICAL SAFETY

- a. **Power tool plugs must match the outlet. Never modify the plug in any way. Do not use any adapter plugs with earthed (grounded) power tools.** Unmodified plugs and matching outlets will reduce the risk of electric shock.
- b. **Avoid body contact with earthed or grounded surfaces, such as pipes, radiators, ranges and refrigerators.** There is an increased risk of electric shock if your body is earthed or grounded.
- c. **Do not expose power tools to rain or wet conditions.** Water entering a power tool will increase the risk of electric shock.
- d. **Do not abuse the cord. Never use the cord for carrying, pulling or unplugging the power tool. Keep the cord away from heat, oil, sharp edges or moving parts.** Damaged or entangled cords increase the risk of electric shock.
- e. **When operating a power tool outdoors, use an extension cord suitable for outdoor use.** Use of a cord suitable for outdoor use reduces the risk of electric shock.
- f. **If operating a power tool in a damp location is unavoidable, use a residual current device (RCD) protected supply.** Use of an RCD reduces the risk of electric shock.

3. PERSONAL SAFETY

- a. **Stay alert, watch what you are doing and use common sense when operating a power tool. Do not use a power tool while you are tired or under the influence of drugs, alcohol or medication.** A moment of inattention while operating power tools may result in serious personal injury.

- b. Use personal protective equipment. Always wear eye protection.** Protective equipment such as dust masks, non-skid safety shoes, hard hats, or hearing protection used for appropriate conditions will reduce personal injuries.
- c. Prevent unintentional starting. Ensure the trigger is in the off-position before connecting to the power source, picking up or carrying the tool.** Carrying power tools with your finger on the switch or energizing power tools that have the switch on invites accidents.
- d. Remove any adjusting key or wrench before turning the power tool on.** A wrench or a key left attached to a rotating part of the power tool may result in personal injury.
- e. Do not overreach. Keep proper footing and balance at all times.** This enables better control of the power tool in unexpected situations.
- f. Dress properly. Do not wear loose clothing or jewelry. Keep your hair, clothing and gloves away from moving parts.** Loose clothes, jewelry or long hair can be caught in moving parts.
- g. If devices are provided for the connection of dust extraction and collection facilities, ensure these are connected and properly used.** Use of dust collection can reduce dust-related hazards.
- h. Do not let familiarity gained from frequent use of tools allow you to become complacent and ignore tool safety principles.** A careless action can cause severe injury within a fraction of a second.

4. POWER TOOL USE AND CARE

- a. Do not force the power tool. Use the correct power tool for your application.** The correct power tool will do the job better and safer at the rate for which it was designed.
- b. Do not use the power tool if it cannot be turned on/off by the switch.** Any power tool that cannot be controlled with the switch is dangerous and must be repaired.
- c. Disconnect the plug from the power source and/or remove the battery pack, if detachable, from the power tool before making any adjustments, changing accessories, or storing power tools.** Such preventive safety measures reduce the risk of starting the power tool accidentally.
- d. Store idle power tools out of the reach of children and do not allow persons unfamiliar with the power tool or these instructions to operate the power tool.** Power tools are dangerous in the hands of untrained users.

- e. **Maintain power tools and accessories. Check for misalignment or binding of moving parts, breakage of parts and any other condition that may affect the power tool's operation. If damaged, have the power tool repaired before use.** Many accidents are caused by poorly maintained power tools.
- f. **Keep cutting tools sharp and clean.** Properly maintained cutting tools with sharp cutting edges are less likely to bind and are easier to control.
- g. **Use the power tool, accessories and tool bits, etc. in accordance with these instructions, taking into account the working conditions and the work to be performed.** Use of the power tool for operations different from those intended could result in a hazardous situation.
- h. **Keep handles and grasping surfaces dry, clean and free from oil and grease.** Slippery handles and grasping surfaces do not allow for safe handling and control of the tool in unexpected situations.

5. BATTERY TOOL USE AND CARE (BATTERY TOOLS)

- a. **Recharge only with the charger specified by the manufacturer.** A charger that is suitable for one type of battery pack may create a risk of fire when used with another battery pack.
- b. **Use power tools only with specifically designated battery packs.** Use of any other battery packs may create a risk of injury and fire.
- c. **When the battery pack is not in use, keep it away from other metal objects, like paper clips, coins, keys, nails, screws or other small metal objects, that can make a connection from one terminal to another.** Shorting the battery terminals together may cause burns or a fire.
- d. **Under abusive conditions, liquid may be ejected from the battery; avoid contact. If contact accidentally occurs, flush with water. If liquid contacts the eyes, additionally seek medical help.** Liquid ejected from the battery may cause irritation or burns.
- e. **Do not use a battery pack or tool that is damaged or modified.** Damaged or modified batteries may exhibit unpredictable behavior resulting in fire, explosion or risk of injury.
- f. **Do not expose a battery pack or tool to fire or excessive temperature.** Exposure to fire or temperature above 130 °C may cause an explosion.
- g. **Follow all charging instructions and do not charge the battery pack or tool outside the temperature range specified in the instructions.** Charging improperly or at temperatures outside the specified range may damage the battery and increase the risk of fire.

6. SERVICE

- a. **Have your power tool serviced by a qualified repair person using only identical replacement parts.** This will ensure that the safety of the power tool is maintained.
- b. **Never service damaged battery packs.** Service of battery packs should only be performed by the manufacturer or authorized service providers.

POLE SAW SAFETY WARNINGS

WARNING:

Do not operate near electrical power lines. The unit has not been designed to provide protection from electric shock in the event of contact with overhead electric lines. Consult local regulations for safe distances from overhead electric power lines and ensure that the operating position is safe and secure before operating the pole saw.

- a. **Keep all parts of the body away from the saw chain or saw blade when the pole saw is operating. Before you start the pole saw, make sure the saw chain or saw blade is not contacting anything.** A moment of inattention while operating the pole saw may result in injury to yourself or others.
- b. **Always use two hands when operating the pole saw.** Hold the pole saw with both hands to avoid loss of control.
- c. **To reduce the risk of electrocution, never use the pole saw near any electrical power lines.** Contact with or use near power lines may cause serious injury or electric shock resulting in death.
- d. **Hold the pole saw by insulated gripping surfaces only, because the saw chain or saw blade may contact hidden wiring or its own cord.** Saw chains or saw blades contacting a "live" wire may make exposed metal parts of the pole saw "live" and could give the operator an electric shock.
- e. **Wear eye and ear protection. Further protective equipment for hands and slip-resistant footwear are recommended.** Adequate protective equipment will reduce the risk of personal injury.
- f. **Always use head protection when operating the pole saw overhead.** Falling debris can result in serious personal injury.
- g. **Always keep proper footing and operate the pole saw only when standing on the ground.** Slippery or unstable surfaces may cause a loss of balance or control of the machine.

- h. Do not operate a pole saw in a tree, on a ladder, or any unstable support.** Operation of a pole saw in this manner may result in loss of balance, loss of control and personal injury.
- i. Keep all power cords and cables away from the cutting area.** Power cords or cables may be hidden in trees and can be accidentally cut by the saw chain or saw blade.
- j. Do not use the pole saw in bad weather conditions, especially when there is a risk of lightning.** This decreases the risk of being struck by lightning.
- k. When cutting a limb that is under tension, be alert for spring back.** When the tension in the wood fibers is released, the spring-loaded limb may strike the operator and/or throw the pole saw out of control.
- l. Use extreme caution when cutting brush and saplings.** The slender material may catch the saw chain or saw blade and be whipped toward you or pull you off balance
- m. When carrying the pole saw with the machine switched off, take care not to operate any power switch and keep the saw chain or saw blade away from your body.** Proper carrying of the pole saw will reduce the likelihood of accidental contact with the saw chain or saw blade
- n. When transporting or storing the pole saw, always fit the guide bar or saw blade cover.** Proper handling of the pole saw will reduce the likelihood of accidental contact with the moving saw chain or saw blade.
- o. Cut wood only. Do not use the pole saw for purposes not intended. For example: do not use the pole saw for cutting plastic, metal, masonry or non-wood building materials.** Use of the pole saw for operations different than intended could result in a hazardous situation.

SAFETY WARNINGS FOR BATTERY PACK

- 1. Do not modify or attempt to repair the battery pack. Do not dismantle, open or shred the battery pack.**
- 2. Do not expose a battery pack or appliance to fire or excessive temperature. Exposure to fire or temperature above 265°F (130°C) may cause an explosion.**

- 3.** Do not short-circuit a battery pack. Do not store battery packs haphazardly in a box or drawer where they may short-circuit each other or be short-circuited by other metal objects. When the battery pack is not in use, keep it away from other metal objects, like paper clips, coins, keys, nails, screws or other small metal objects, that can make a connection from one terminal to another. Shorting the battery terminals together may cause burns or fire.
- 4.** Do not subject the battery pack to mechanical shock.
- 5.** Observe the plus (+) and minus (-) marks on the battery back and equipment and ensure correct use.
- 6.** Keep the battery pack out of the reach of children.
- 7.** Always purchase the battery pack recommended by the device manufacturer for the equipment.
- 8.** Keep battery pack clean and dry.
- 9.** Wipe the battery pack terminals with a clean dry cloth if they become dirty.
- 10.** The battery pack needs to be charged before use. Always use the correct charger and refer to the manufacturer's instructions or equipment manual for proper charging instructions.
- 11.** Do not leave the battery pack on prolonged charge when not in use.
- 12.** After extended periods of storage, it may be necessary to charge and discharge the battery pack several times to obtain maximum performance.
- 13.** Battery pack gives its best performance when it is operated at normal room temperature ($20\text{ }^{\circ}\text{C} \pm 5\text{ }^{\circ}\text{C}$).
- 14.** Use only the battery pack in the application for which it was intended. Do not use a battery pack or appliance that is damaged or modified. Damaged or modified batteries may exhibit unpredictable behavior resulting in fire, explosion or risk of injury.
- 15.** Remove the battery pack from the equipment when not in use.
- 16.** Dispose of properly.
- 17.** Do not handle the charger, including the charger plug, or charger terminals with wet hands.
- 18.** Do not charge the battery pack outdoors, in rain, or in wet locations.
- 19.** Recharge only with the charger specified by the manufacturer. A charger that is suitable for one type of battery pack may create a risk of fire when used with another battery pack.

- 20.** Use power tools only with specifically designated battery packs. Use of any other battery packs may create a risk of injury and fire.
- 21.** Under abusive conditions, liquid may be ejected from the battery; avoid contact. If contact accidentally occurs, flush with water. If liquid contacts the eyes, additionally seek medical help. Liquid ejected from the battery may cause irritation or burns.

Save these instructions. Refer to them frequently and use them to instruct others who may use this tool. If you lend this tool to someone else, also lend these instructions to them to prevent misuse of the product and possible injury.











SAFETY SYMBOLS





The purpose of safety symbols is to attract your attention to possible danger. The safety symbols and the explanations with them deserve your careful attention and understanding. The symbol warnings do not, by themselves, eliminate any danger. The instruction and warnings they give are no substitutes for proper accident prevention measures.

The following signal words and meanings are intended to explain the levels of risk associated with this product.

SYMBOL	SIGNAL	MEANING
	WARNING	Indicates a hazardous situation, which, if not avoided, could result in death or serious injury.
	NOTICE	(Without Safety Alert Symbol) Indicates information considered important, but not related to a potential injury (e.g. messages relating to property damage).

Some of the following symbols may be used on this product. Please study them and learn their meaning. Proper interpretation of these symbols will allow you to operate the product better and safer.

SYMBOL	Description
	To reduce the risk of injury, the user must read the instruction manual.
	SAFETY ALERT - indicate a precaution, a warning or a danger.
	Do not expose to rain.
	Wear hearing and eye protection.
	Keep bystanders away.
	CAUTION! Beware of stones or other foreign objects that could be thrown from the appliance.
	DANGER - Keep sufficient distance away from electrical power lines.
	Indoor use only. Only use the battery charger indoors.
	Wear safety footwear.
	Wear protective gloves. Protect your hands with gloves when handling the saw and saw chain. Heavy-duty, nonslip gloves improve your grip and protect your hand.

	<p>Do not burn the battery pack.</p>
	<p>Batteries may enter the water cycle if disposed of improperly, which can be hazardous to the ecosystem. Do not dispose of old batteries as unsorted municipal waste.</p>
 Li-Ion 	<p>Li-ion battery. This product has been marked with a symbol relating to a 'separate collection' for all battery packs. It will then be recycled or dismantled to reduce the impact on the environment. Battery packs can be hazardous to the environment and to human health since they contain hazardous substances.</p>
	<p>WARNING - Disconnect the battery before maintenance.</p>

KNOW YOUR TOOL

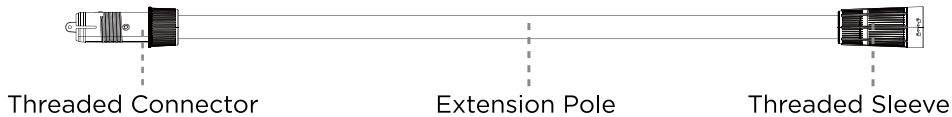
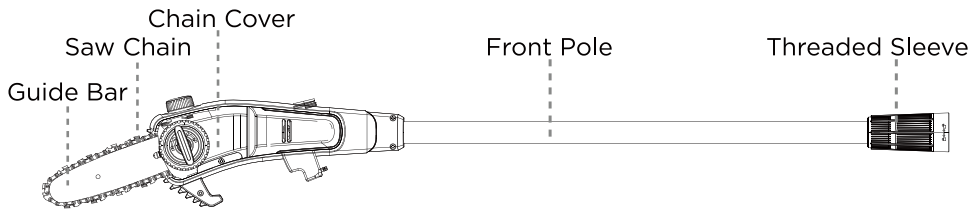

Bar and Chain Sheath



Shoulder Strap



Chain-tension Adjusting Sleeve

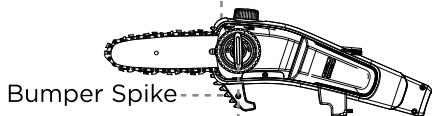

Chain Cover
Locking Knob

Oil-inspection Window

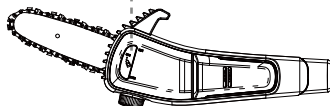

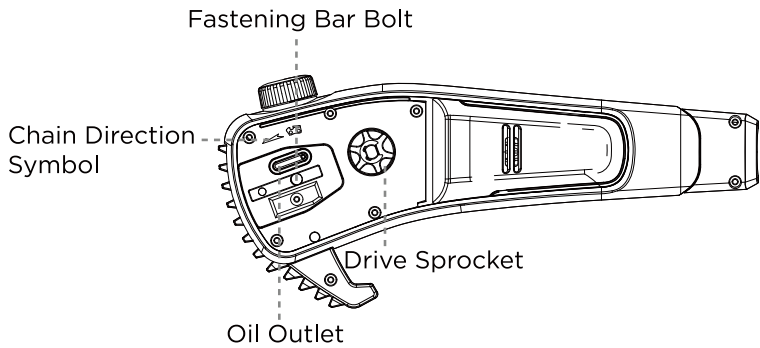
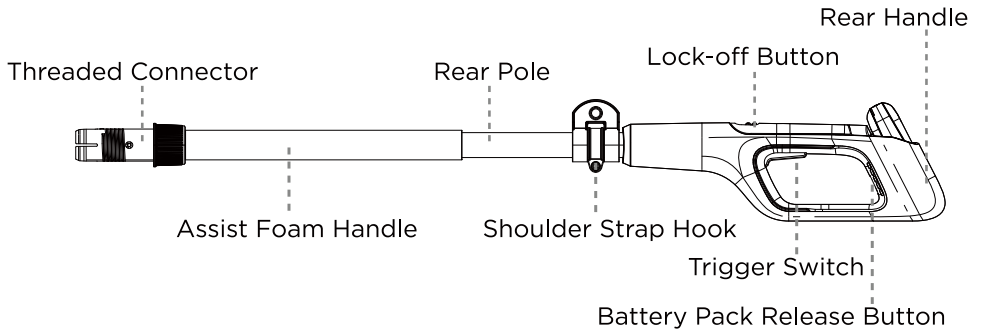

Technical Data

Model No.	U20PS00-0A110
No-load Motor Speed	19500RPM±10%
Bar Length	8"(200mm)
Chain Speed	8m/s±10%
Oil Tank Capacity	≥140ml
Chain Pitch	3/8"
Chain Gauge	0.043"
Machine Weight (Battery Excluded)	9.92 lbs(4.5kg)
Battery Capacity	2.5Ah
Recommended Working Temperature	5 - 104°F (-15 - 40°C)
Recommended Storage Temperature	32 - 104°F (0 - 40°C)

* Charger is not supplied with this product. You should prepare a 45W charger to work with the supplied charging cable for charging.

ACCESSORIES

Model No.	D06102450
Battery Pack	1pc
Guide Bar	1pc
Saw Chain	1pc
Bar and Chain Sheath	1pc
Shoulder Strap	1pc

CHARGING YOUR BATTERY

WARNING:

Charge the battery in a dry and ventilated room, far away from combustibles and ignition sources.

NOTICE: The charger is not supplied with this appliance. You should prepare a 45W charger to work with the supplied charging cable for charging. Make sure the charger meets the requirement (Max. Charging Input) in Technical Data.

NOTICE: Lithium-ion batteries are shipped partially charged. Before using it the first time, fully charge the battery.

NOTICE: Please refer to the Charging Your Battery section of the battery pack manual for details of the indicated lights display and charging considerations.

ASSEMBLY

WARNING:

To prevent accidental starting that could cause serious personal injury, always remove the battery pack from the tool when assembling parts.

WARNING:

Do not attempt to modify this tool or create accessories not recommended for use with this tool. Any such alteration or modification is misused and could result in a hazardous condition leading to serious injury.

WARNING:

Do not attempt to start the tool before it has been completely assembled.

WARNING:

Always wear heavy-duty work gloves when handling the saw chain.

UNPACKING

- This product requires assembly.
- Remove all the items from the carton. Make sure that all items listed in the parts list are included.
- Inspect the product carefully to make sure that no breakage or damage occurred during shipping.
- Do not discard the packing material until you have carefully inspected and satisfactorily operated the tool.
- If any parts are damaged or missing, please return the tool to the place of purchase.

CONNECTING THE POLES

Attaching Without the Extension Pole (Fig. 1)

1. Remove the battery pack.
2. Align the rib on the front pole with the arrow slot on the rear pole and push the front pole into the rear pole.
3. Rotate the threaded sleeve, according to the direction marked on it, to fasten it onto the threaded connector securely.
4. Pull on the front pole to verify that it is securely locked in place.

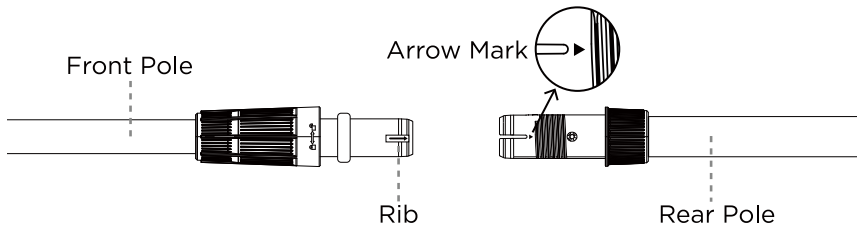

Fig. 1

Attaching the Extension Pole (Fig. 2)

The extension pole extends the cutting range. It should be connected between the front pole and the rear pole.

Follow the previous instructions to connect the front pole to one end of the extension pole, and then connect the rear pole to the other end of the extension pole the same way.

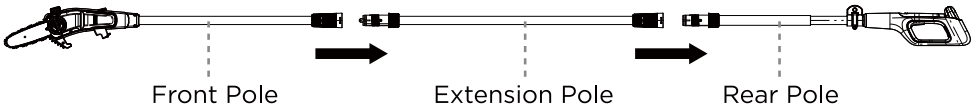

Fig. 2

NOTICE: Do not use the screw sleeves as handles during operation. Only hold the screw sleeve during transportation.

⚠ WARNING:

Be certain that the threaded sleeves are fully tightened before operating the tool. Check it periodically for tightness during use to avoid serious personal injury.

BAR AND CHAIN ASSEMBLY

NOTICE: Before first use: Soak saw chain in bar and chain oil (not included) overnight.

1. Place the pole saw on a suitable flat surface with the chain cover facing upwards. Remove the chain cover by turning the chain cover locking knob in a counterclockwise direction. (Fig. 3)

Rotation Direction Symbol

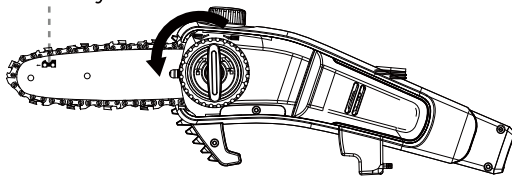

Fig. 3

2. Slide the chain in the slot around the guide bar, making sure the chain is installed in the correct rotation direction. (Fig. 4)

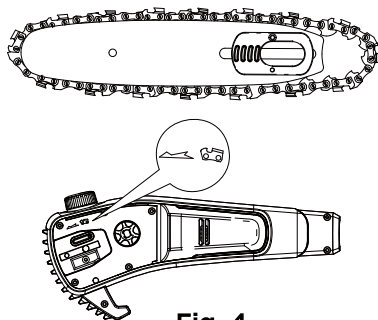

Fig. 4

3. Fit the chain onto the drive sprocket, and make sure the fastening bar bolt on the bar pad fits into the keyway of the opening on the guide bar, and the tension pin on the bar pad fits into the groove (A) on the guide bar. (Fig. 5, 6)

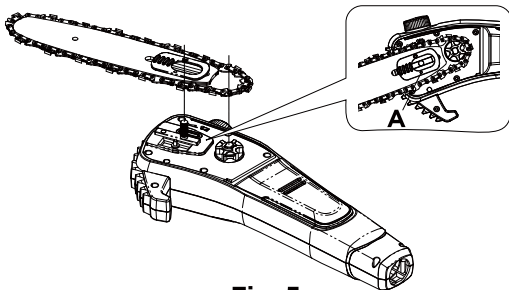

Fig. 5

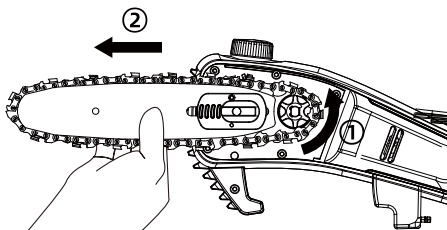

Fig. 6

4. Assure all parts are seated properly and hold the chain and guide bar in a level position. Make sure the drive links are fully seated in the drive sprocket (Fig. 7), avoiding a kink as shown in (Fig. 8) . If a kink occurs, pick up on the chain at the guide bar just ahead of the kink and then pull the kink out.

NOTICE: The chain should rotate freely and be free of kinks.

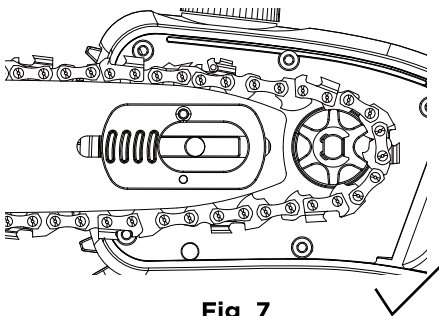

Fig. 7

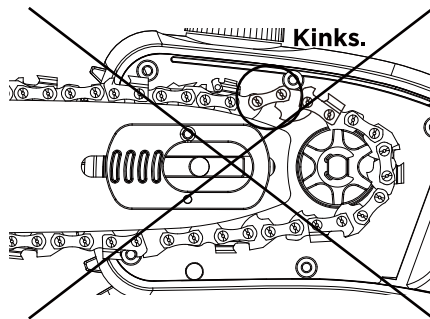

Fig. 8

5. Fit the chain cover and tighten the chain cover by turning the chain cover locking knob clockwise until it is tight. (Fig.9)

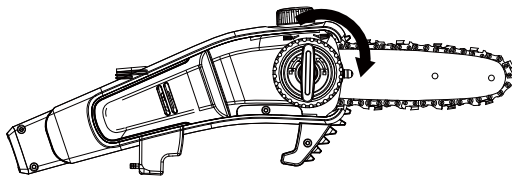

Fig. 9

⚠ WARNING:
The chain is not yet tensed. Tensing the chain applies as described under “TENSIONING CHAIN”. The chain now needs to be checked for tension first.

CHECKING SAW CHAIN TENSION

⚠ WARNING:

Remove the battery pack before checking chain tension.

1. While wearing heavy-duty gloves, use your index finger and thumb to carefully grab the saw chain in the middle section under the guide bar.
2. Pull the chain away from the guide bar. (Fig. 10)
3. The chain should snap back against the guide bar. The chain should fit snugly in the groove of the guide bar, yet you should still be able to slide the chain along the guide bar by hand.
4. There should be no sagging between the guide bar and chain on the underside of the guide bar.

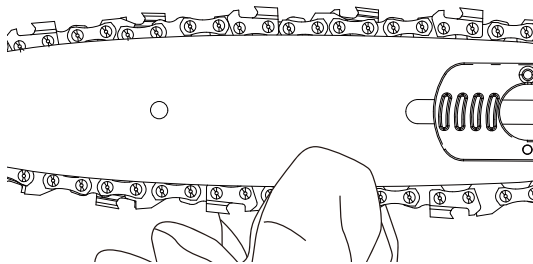

Fig. 10

TENSIONING CHAIN

NOTICE: New saw chains will stretch. Check the chain tension frequently when first used and tighten when the chain becomes loose around the guide bar.

NOTICE: The chain will stretch and lose proper tension while cutting. Always pay attention to the chain tension while working.

⚠ WARNING:

- **Remove the battery pack before adjusting saw chain tension.**
- **Cutting edges on the chain are sharp. Use protective gloves when handling the chain.**

- **Maintain proper chain tension always. A loose chain will increase the risk of kickback. A loose chain may jump out of the guide bar groove. This may injure the operator and damage the bar. A loose chain will cause the chain, bar, and sprocket to wear rapidly.**

1. Place the pole saw on a suitable flat surface.
2. Loosen the chain cover locking knob by turning it counter-clockwise.
3. Adjust the chain tension with the chain tension adjusting sleeve according to chain tension adjusting mark on the side cover. Turning the sleeve clockwise increases the chain tension. Turning it counterclockwise decreases the chain tension. (Fig. 11).

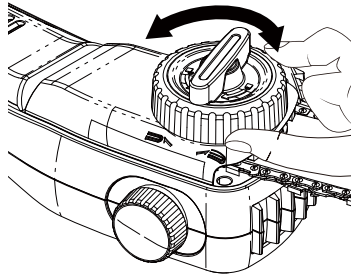

Fig. 11

4. Check the chain tension using one hand, by pulling upwards on the chain against the weight of the product. The correct chain tension is achieved when the saw chain can be lifted by approximately 5/64" (2mm) from the guide bar in the center (Fig. 12).

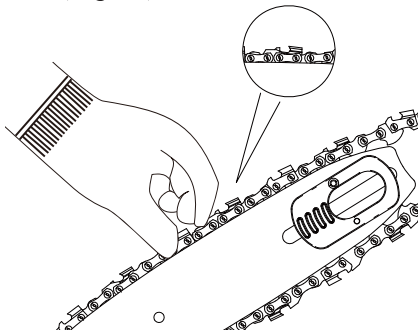

Fig. 12

5. Re-adjust the tension as described above if you find that the saw chain is too loose or tight.
6. Pull the saw chain along the upper side of the guide bar by hand (WEAR PROTECTIVE GLOVE!) from one end to the other several times. The chain should feel tight but still move freely.
7. Tighten the locking knob firmly to fix the guide bar.

LUBRICATION

⚠ WARNING:

The pole saw is not filled with oil. It is essential to fill it with oil before use. Never operate the pole saw without chain oil or at an empty level, as this will result in extensive damage to the product.

NOTICE: Chain life and cutting capacity depend on optimum lubrication. Fill the oil tank with a proper amount of oil before each use, and the oil tank will automatically oil the chain.

CHECKING OIL LEVEL

Check the oil level from the oil level window prior to each starting and regularly during operation. (Fig. 13) You should fill the oil tank when the oil level reaches the MIN mark.

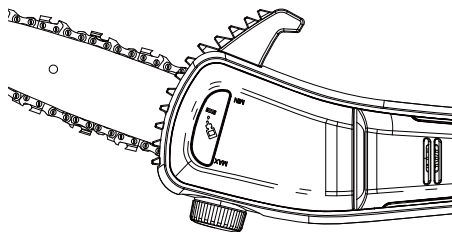

Fig. 13

FILLING OIL TANK

⚠ WARNING:

Remove the battery pack before filling the oil tank.

1. Set the pole saw on any suitable surface with the oil tank cap facing upward. Clean the area around the oil tank cap with cloth and unscrew the cap by turning it counter-clockwise. (Fig. 14)
Add bar and chain oil until the oil tank is full.(Fig. 15)
3. Avoid dirt or debris entering the oil tank, refit the oil tank cap and tighten by turning clockwise.

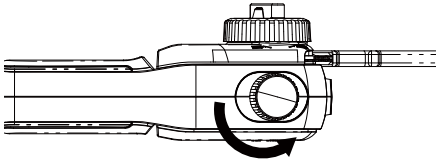

Fig. 14

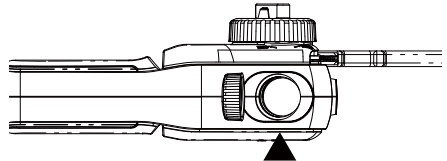

Fig. 15

⚠ WARNING:

To allow venting of the oil tank, small breather channels are provided between the oil tank cap and the strainer, to prevent leakage, and ensure the machine is left in a horizontal position when not in use.

It is important to use only the recommended standard bar and chain oil to avoid damage to the pole saw. This can be found at the location where you purchased this saw or at your local hardware store. Never use recycled/old oil. Use of non-approved oil will void the warranty.

Do not swallow. If swallowed, call a physician immediately. Keep out of reach of children. Store away from heat or open flame.

ATTACHING THE SHOULDER STRAP

For efficient, comfortable and safe work, the shoulder strap is necessary to be attached to the pole saw.

1. Change the location of the shoulder strap hook if required. Loosen the hex bolt and move the shoulder strap hook to a suitable position. Re-tighten the hex bolt (d). (Fig. 16)

2. Clip the shoulder strap onto the hole of the shoulder strap hook. (Fig. 17)

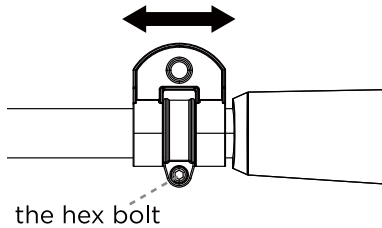

Fig. 16

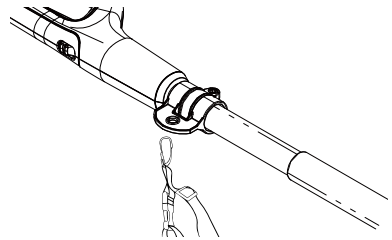

Fig. 17

INSTALLING OR REMOVING THE BATTERY PACK

To install:(Fig. 18)

Push the battery into the battery compartment behind the handle, in the correct direction and position (the battery power indicator light is facing outwards), and push the battery to the end.

NOTICE:The battery can only be installed in one way.

To remove:(Fig. 19)

Press the battery release button, and the battery will pop out from the compartment automatically. Hold the battery and remove them from the machine.

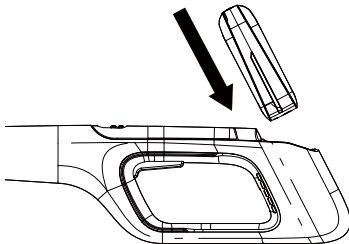

Fig. 18

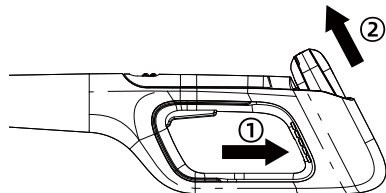

Fig. 19

OPERATION

WARNING:

Do not allow familiarity with this product to make you careless. Remember that a careless fraction of a second is sufficient to inflict serious injury.

WARNING:

Do not use any attachments or accessories not recommended by the manufacturer of this product. The use of attachments or accessories not recommended can result in serious personal injury.

WARNING:

- Wear necessary personal protective equipment (PPE) such as ANSI-approved safety goggles, head protection and steel-toed boots during use.
- Avoid kickback. Do not touch the guide bar tip to any object. Tip contact may cause the guide bar to move suddenly upward and backward.
- NEVER operate the pole saw with one hand. ALWAYS hold the pole saw with both hands. Do not stand directly under the branch being cut.
- Only stand on fixed, secure and level surfaces. Do not stand on a ladder or other support.
- Do not operate within 50 feet of electrical lines.

HOLDING THE POLE SAW

Balance your weight with both feet on solid ground. Your body should always be to the left of the chain line. Firmly grip the pole saw with both hands at all times during operation, with one hand gripping the rear handle tightly and the other hand gripping the soft grip area on the lower pole. Always hold the pole saw at an angle of max. 60° from the horizontal level. (Fig. 20)

WARNING: Do not overreach.

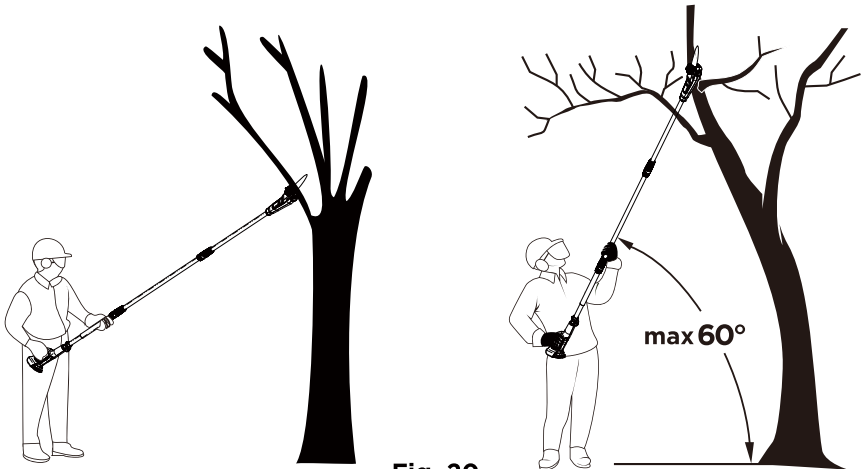

Fig. 20

USING THE SHOULDER STRAP

The shoulder strap helps to balance the pole saw and distribute the weight of the pole saw across the body, increasing comfort for extended use. Attach the shoulder strap correctly before starting the pole saw.

- **Wear the shoulder strap over the head and the shoulder opposite the hand holding the on/off switch.**
- **Adjust the shoulder strap length so that the clip is about the same height as the hip (Fig. 21).**

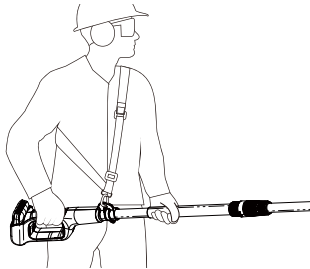

Fig. 21

This shoulder strap is equipped with a quick-release mechanism that can be operated with one hand. (Fig. 22)

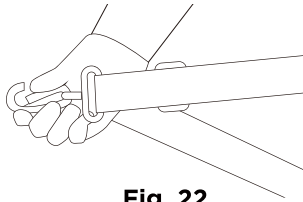

Fig. 22

STARTING/STOPPING THE POLE SAW

Before every use:

- a. Check the oil level, and add oil as necessary.
- b. Run the pole saw for several minutes.
- c. Stop the motor and remove the battery pack. Let the chain cool, then check the chain tension and adjust it as necessary.
- d. Make sure the saw chain is sharp and the automatic oil tank is distributing oil.

During every use:

- a. Check tension often during the first half hour of use and periodically during use. Adjust chain tension as necessary.
- b. Check the oil level every 10 minutes of use. Fill the oil tank when the oil level reaches the MIN mark.

To start the pole saw:

Depress the lock-off button, then fully press the on/off switch and hold it in this position. With the pole saw running, the lock-off button can be released. (Fig. 23)

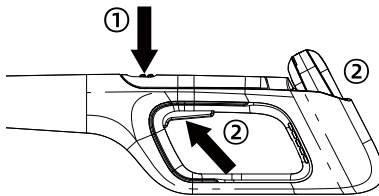

Fig. 22

To stop the pole saw:

For switching off, release the on/off switch.

STARTING/STOPPING THE POLE SAW

1. Install the battery pack and fill the oil tank. Use both hands to firmly grip the pole saw and divide your weight evenly with both feet on solid ground.
2. Start the pole saw. Make sure the saw is running at full speed before starting a cut.
3. Cut lower branches first to allow the top branches more room to fall.
4. When starting a cut, place the moving chain against the wood. Hold the pole saw firmly in place to avoid possible bouncing or skating (sideway's movement) of the saw.
5. Guide the pole saw using light pressure. Do not force the pole saw. The motor will overload and can burn out. It will do the job better and safer at the rate for which it was intended.
6. Use caution when reaching end of cut. The pole saw's weight may change unexpectedly as it cuts free from the wood. Remove the pole saw from a cut with the saw running at full speed. Stop the pole saw by releasing the on/off switch. Make sure the chain has stopped before setting the pole saw down.
7. Keep practicing on scrap logs in a secure working area until you are comfortable, using a fluid motion and a steady cutting rate.

WARNING:

To prevent serious injury, if the branch starts to fall, causing the saw to bind, leave the saw and get away from where the saw and branch are likely to fall immediately.

WARNING:

Do not stand directly below a branch being cut. Keep bystanders far away, especially children. Do not stand on a ladder or other type of unstable support while using the tool. Do not use the tool near cable, electrical power or telephone lines. Keep 50ft (15m) away from all power lines. (Fig. 24)

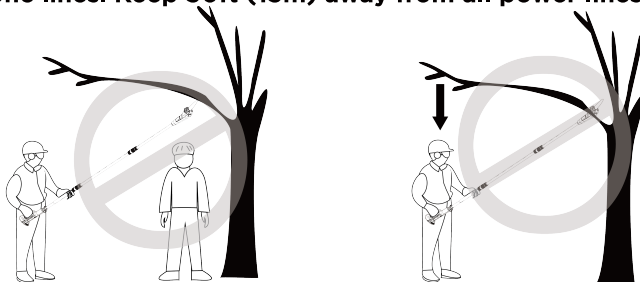

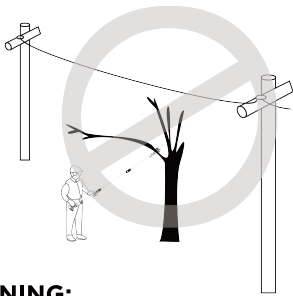

Fig. 24

! WARNING:

Do not operate the pole saw with arms fully extended or attempt to saw in areas that are difficult to reach.

CUTTING THIN BRANCHES

Thin branches can be cut off with a single cut. To prevent the branch from splintering and buckling, cut the branch off in several pieces.

CUTTING LONG BRANCHES (Fig. 25)

1. Make the first cut 4" to 6" from the end of the branch.
2. Make the next cuts 4" to 6" from the previous cuts, working toward the trunk.

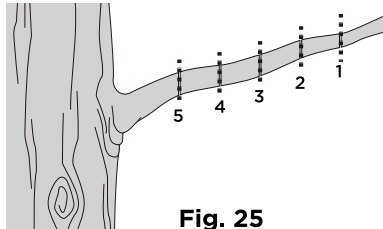

Fig. 25

CUTTING THICK BRANCHES (Fig. 26)

While cutting thick branches, make sure your footing is firm. Keep feet apart. Divide your weight evenly on both feet. Follow the directions below.

1. Make Cut 1 six inches from the tree trunk on underside of the limb. Use the top of the guide bar to make this cut. Cut 1/3 through the diameter of a branch.
2. Move two to four inches away from Cut 1. Make Cut 2 from the top. Continue to cut until you cut the branch off.
3. Make Cut 3 as close to the tree trunk as possible on underside of the limb stub. Use the top of the guide bar to make this cut. Cut 1/3 through the diameter of a stub.
4. Make Cut 4 directly above the third cut. Cut down to meet the third cut. This will remove the limb stub.

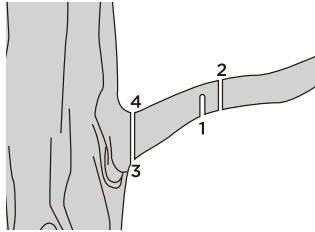

Fig. 26

KICKBACK SAFETY DEVICES ON THIS SAW

This saw has a low-kickback chain and reduced kickback Guide Bar. Both items reduce the chance of kickback. However, kickback can still occur with this saw. The following steps will reduce the risk of kickback.

- Use both hands to grip the tool while the saw is running. Use a firm grip. Thumbs and fingers must wrap around saw handles.
- Keep all safety items in place on the saw. Make sure they work properly.
- Do not overreach.
- Keep solid footing and balance at all times.
- Stand slightly to the left side of the saw. This keeps your body from being in direct line with the chain.
- Do not let the guide bar nose touch anything when the chain is moving.
- Never try cutting through two branches at the same time. Only cut one branch at a time.
- Do not bury the guide bar nose or try plunge cut (boring into wood using guide bar nose).
- Watch for shifting of wood or other forces that may pinch the chain.
- Use extreme caution when reentering a previous cut.

- Use only the low-kickback chain and guide bar that were supplied with this pole saw or recommended.
- Never use a dull or loose chain. Keep the chain sharp with proper tension.

MAINTENANCE

WARNING:

When servicing, use only identical replacement parts. Use of any other parts may create a hazard or cause product damage. To ensure safety and reliability, all repairs should be performed by a qualified service technician.

WARNING:

To prevent serious personal injury, remove the battery pack from the tool before servicing, cleaning, changing add-on attachments or removing material from the unit.

WARNING:

For the user's safety, worn or damaged parts must be replaced. Replace with original replacement parts only.

WARNING:

To prevent serious injury from appliance failure, do not use damaged equipment. Have the problem corrected before further use if abnormal noise or vibration occurs.

WARNING:

After use, return the extension pole to its original position (fully retracted). Otherwise, the extension pole will be spring-loaded.

GENERAL MAINTENANCE TIPS

1. Do not attempt to repair the machine unless you have the proper tools and instructions for the disassembly and repair of the machine.
2. Check bolts, screws and fasteners at frequent intervals for proper tightness to ensure that the machine is in safe working condition.

3. BEFORE EACH USE, inspect the general condition of the appliance. Check for:
 - loose hardware,
 - misalignment or binding of moving parts,
 - cracked or broken parts,
 - dull or damaged saw chain,
 - and any other condition that may affect its safe operation.
4. BEFORE EACH USE, tension the saw chain and fill the oil tank.

CLEANING

Regular cleaning and maintenance of your pole saw will ensure efficiency and prolong the life of the product.

- After each use, scrape debris loose from the inside chain cover and around the drive sprocket, and then wipe with a clean and dry cloth.
- Never wet or spray water on the machine. Do not immerse the tool in liquid.
- Do not use any detergents or solvents as these could cause irreparable damage to the pole saw. Chemicals can destroy plastic parts.
- Clean outside surfaces with a clean, dry cloth.

SAW MAINTENANCE

Follow the maintenance instructions in this manual.

Proper cleaning and maintenance of the chain and guide bar can reduce the chance of kickback. Inspect and maintain the saw after each use. This will increase the service life of your saw.

NOTICE: Even with proper sharpening, the risk of kickback can increase with each sharpening.

MAINTENANCE AND STORAGE

1. Remove the battery pack
 - When not in use.
 - Before moving from one place to another.
 - Before servicing.
 - Before changing accessories or attachments, such as saw chain and guide bar.
2. Inspect the pole saw before and after each use.

Check the saw closely if the guide bar or other part has been damaged. Check for any damage that may affect operator safety or operation of the saw. Check for alignment or binding of moving parts. Check for broken or damaged parts. Do not use the pole saw if the damage affects safety or operation. Have damage repaired by an authorized service center.
3. Maintain the pole saw with care.
 - Never expose the saw to rain or direct moisture.
 - Keep the chain sharp, clean, and lubricated for better and safer performance.
 - Follow the steps outlined in this manual to sharpen the chain.
 - Keep handles dry, clean, and free of oil and grease.
 - Keep all screws and nuts tight.
4. When servicing, use only identical replacement parts.
5. When not in use, always store the pole saw
 - in a high or locked place, out of children's reach
 - in a dry place
 - with bar and chain sheath in place

Bar Maintenance

To maximize bar life, the following bar maintenance is recommended.

The bar rails that carry the chain should be cleaned before storing the tool or if the bar or chain appears to be dirty.

The rails should be cleaned every time the chain is removed.

To clean the bar rails:

1. Remove the chain cover, bar and chain. (see section BAR AND CHAIN ASSEMBLY)
2. Using a wire brush, screwdriver or similar tool, clear the residue from the inner groove of the bar (Fig. 27).
3. Make sure to clean oil passages thoroughly.

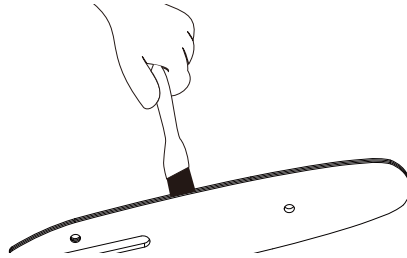

Fig. 27

Conditions that require chain and guide bar maintenance:

- Saw cuts to one side or at an angle.
- Saw has to be forced through the cut.
- Inadequate supply of oil to the bar and chain.

Check the condition of the guide bar each time the chain is sharpened. A worn guide bar will damage the chain and make cutting difficult.

After each use, remove the battery pack, clean all sawdust from the guide bar and sprocket hole.

When rail top is uneven, use a flat file to restore square edges and sides.



Replace the guide bar when the groove is worn, the guide bar is bent or cracked, or when excess heating or burring of the rails occurs. If replacement is necessary, use only the guide bar specified for your saw in the repair parts list.

Replacing Bar & Chain

Replace the chain when cutters are too worn to sharpen or when the chain stops. Only use the replacement chain noted in this manual.

Inspect the guide bar before sharpening the chain. A worn or damaged guide bar is unsafe. A worn or damaged guide bar will damage the chain. It will also make cutting harder.

SHARPENING SAW CHAIN



WARNING:

Remove the battery pack before servicing. Severe injury or death could occur from electrical shock or body contact with a moving chain. Cutting edges on the chain are sharp. Use protective gloves when handling the chain.

Keep the chain sharp. Your saw will cut faster and more safely. A dull chain will cause undue sprocket, Guide Bar, chain, and motor wear. If you must force the chain into wood and cutting creates only sawdust with few large chips, the chain is dull. Have the cutters sharpened by a qualified technician.

LUBRICATE SPROCKET



WARNING:

Wear heavy-duty gloves when performing any maintenance or service to this tool. Always remove the battery pack before performing any service or maintenance on this tool.

NOTICE: It is not necessary to remove the chain or bar when lubricating the guide bar sprocket.

1. Clean the bar and sprocket.
2. Using a grease gun, insert the tip of the gun into the lubrication hole and inject grease until it appears at the outside edge of the sprocket tip. (Fig. 28)
3. To rotate the sprocket, pull the chain by hand until the ungreased side of the sprocket is in line with the grease hole. Repeat the lubrication procedure.

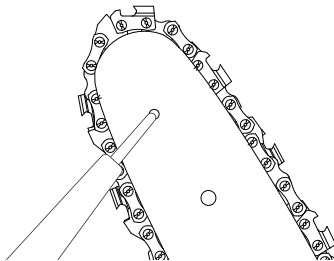

Fig. 28

STORAGE

Pole saw:

1. Clean the bar and sprocket.
2. Using a grease gun, insert the tip of the gun into the lubrication hole and inject grease until it appears at the outside edge of the sprocket tip. (Fig. 28)
3. To rotate the sprocket, pull the chain by hand until the ungreased side of the sprocket is in line with the grease hole. Repeat the lubrication procedure.

Battery and charger:

1. Do not expose your battery pack or charger to water, or rain or allow them to get wet. This could permanently damage the charger and the battery pack. Do not use oil or solvents to clean or lubricate your battery pack as the plastic casing can become brittle and crack, causing a serious risk of injury.
2. Store the battery pack and charger at room temperature away from moisture. Do not store in damp locations where corrosion of terminals may occur. As with other battery pack types, a permanent capacity loss can result if the pack is stored for long periods of time at high temperatures (over 120°F/49°C).
3. For longer service life of battery packs, recharge the battery pack every month when not in use.

For battery-powered tools

The ambient temperature range for the use and storage of tool and battery is 0°C-45°C (32°F-113°F).

The recommended ambient temperature range for the charging system during charging is 10°C-40°C (50°F-104°F). While charging, the battery and charger should be placed in a cool, dry indoor place with good ventilation.

TROUBLESHOOTING

The following table gives checks and actions that you can perform if your machine does not operate correctly. If these do not identify/remedy the problem, contact your service agent.

WARNING:

Switch off the machine and remove the battery packs prior to any troubleshooting.

Problem	Possible causes	Remedy
Motor does not start.	Battery is not installed well.	Make sure the battery is fully inserted.
	Battery is depleted.	Charge the battery.
	Battery is too cold.	Allow the battery to warm up.
	Lock-off button is not depressed.	Depress the lock-off button first, and then press the on/off switch.
	On/off switch is defective.	Contact the service center for replacement.
	Debris is in bar groove or in chain cover.	Remove the battery pack, remove the chain cover and clean out the debris.

Motor runs, but the chain does not rotate.	Chain tension is too tight.	Check chain tension and re-tension the chain.
	Chain does not engage with the drive sprocket.	Re-assemble the chain and bar.
	Chain is damaged.	Replace the chain.
Pole saw operates intermittently.	The machine is overheating.	Place the machine in a cool, ventilated place to cool it down.
	Applying too much pressure while cutting.	Applying relatively less pressure while cutting.
	Connection is loose.	Contact the service center.
	Internal wiring is defective.	Contact the service center.
	On/Off switch is defective.	Contact the service center.
Chain is dry.	No oil in the oil tank.	Refill the oil.
	Oil passage is clogged.	Clean the oil passage outlet.
Chain or bar overheats.	No oil in the oil tank.	Refill oil.
	Oil passage is clogged.	Clean the oil passage outlet.
	Chain is over tensed.	Adjust chain tension.
	Chain is dull.	Sharpen or replace the chain.
Pole saw rips, vibrates, does not saw properly.	Chain tension is too loose.	Adjust chain tension.
	Chain is dull.	Sharpen or replace the chain.
	Chain is worn out.	Replace the chain.
	Chain teeth are facing in the wrong direction.	Reassemble with chain in the correct direction.

WARRANTY

Litheli WARRANTY POLICY

- 3-year limited warranty on Litheli outdoor power equipment and power tools for personal, household use.
- 1-year limited warranty on Litheli battery packs and chargers for personal, household use.

Please contact Litheli customer service at service@litheli.com any time you have questions or warranty claims.

LIMITED WARRANTY SERVICE

FOR THREE YEARS from the date of original retail purchase, this Litheli outdoor power equipment and power tools are warranted against defects in material or workmanship. Defective product will receive free repair or will be exchanged.

FOR ONE YEAR from the date of original retail purchase, the Litheli battery pack and charger are warranted against defects in material or workmanship. Defective product will receive free repair or be exchanged.

1. This warranty applies only to the original purchaser from an authorized Litheli shop and may not be transferred.
2. The warranty period for any Litheli product, battery pack and charger used for residential only.
3. The warranty period for routine maintenance parts, such as, but not limited to, blades, trimmer heads, chain bars, saw chains, belts, scraper bars, blower nozzles, and all other Litheli accessories is 90 days for residential purposes.
4. This warranty does not cover the damage resulting from modification, alteration or unauthorized repair.
5. This warranty only covers defects arising under normal usage and does not cover any malfunction, failure or defect resulting from misuse, abuse (including overloading of the product beyond capacity and immersion in water or other liquid), accidents, neglect or lack of proper installation, and improper maintenance or storage.
6. This warranty does not cover normal deterioration of the exterior finish including but not limited to scratches, dents, paint chips, or to any corrosion or discoloring by heat, abrasive and chemical cleaners.

WARRANTY CLAIM

For warranty claims, please contact Litheli Customer Service at service@litheli.com. You will need to submit a registration document or proof of purchase in the form of a valid receipt that displays the date and place of purchase. Replacement products do not come with a new warranty. The warranty of the products will continue from the date of the original purchase.

litheli tool

TOOLS FOR THE FUTURE



+1 (800) 323-8991



www.Litheli.com



service@litheli.com