



ASSEMBLY INSTRUCTIONS

Pour le français, voir la page 3. Para el español, ver la página 2.

8'x10' OUTDOOR STORAGE SHED

MODEL 60356

BEFORE ASSEMBLY:

- Assemble on a level platform
- At least 3 people recommended for setup
- Inspect all parts and hardware. Ensure all are included using the *Parts Identifier* in the middle of these instructions. The *Parts Identifier*, in yellow, can be removed from the instructions for quick reference

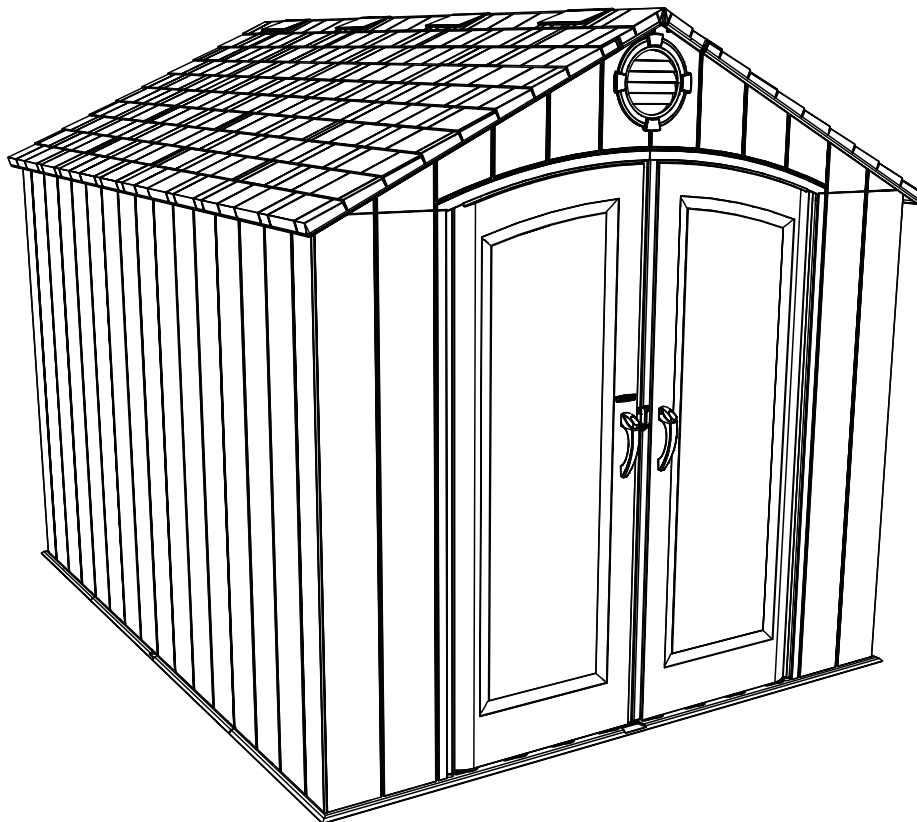

TOOLS REQUIRED



TABLE OF CONTENTS

| | |
|-----------------------------|----|
| Icon Legend..... | 4 |
| Warnings & Notices..... | 5 |
| Platform Construction..... | 6 |
| Truss Assembly..... | 11 |
| Gable Assembly..... | 16 |
| Door Assembly..... | 21 |
| Floor Assembly..... | 30 |
| Wall Assembly..... | 34 |
| Parts Identifier..... | 37 |
| Shelving Installation..... | 43 |
| Door Installation..... | 46 |
| Roof Assembly..... | 50 |
| Window Installation..... | 60 |
| Wall Hook Installation..... | 63 |
| Door Alignment..... | 65 |
| Shed Anchoring..... | 68 |
| Cleaning & Care..... | 71 |
| Registration..... | 72 |
| Warranty..... | 73 |

QUESTIONS?

Call: 1-800-225-3865
7:00 am–5:00 pm (Monday–Friday) MST
and 9:00 am–1:00 pm Saturday MST

CONTACT OUR CUSTOMER SERVICE:

Web: www.lifetime.com/customerservice
(Click on the "LIVE CHAT" tab)
For Customer Service in mainland Europe:
E-mail: cs@lifetimeproducts.eu

MODEL# AND PRODUCT ID (you will need both when contacting us)

Model Number: 60356

Product ID:



INSTRUCTIONS D'ASSEMBLAGE

For English, see page 1. Para el español, ver la página 3.

ABRI EXTÉRIEUR DE 2,44 x 3,81m

MODÈLE n° 60356

AVANT L'ASSEMBLAGE :

- Assembler sur une plate-forme nivelée
- Nous recommandons, au moins, 3 adultes pour l'assemblage
- Examiner toutes les pièces et quincaillerie. Vérifier qu'elles sont incluses en utilisant l'*Identificateur de pièces* au milieu de ces instructions. Il est possible enlever l'*Identificateur de pièces*, en jaune, des instructions pour référence rapide

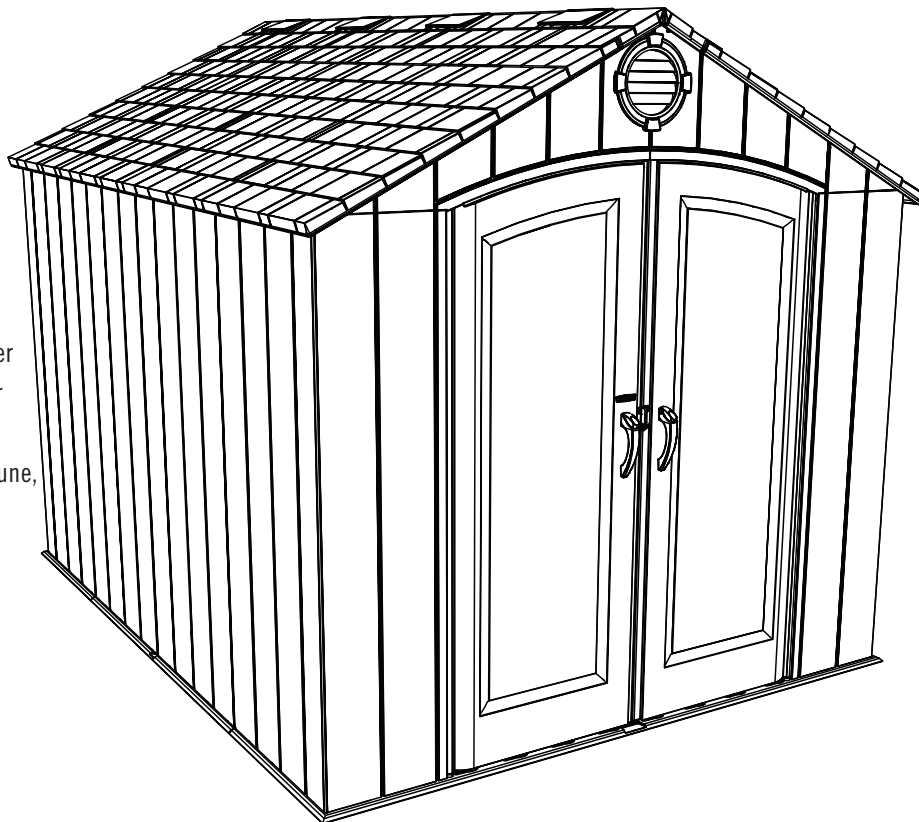

OUTILS REQUIS



SOMMAIRE

| | |
|---------------------------------------|----|
| Légende des icônes..... | 4 |
| Avertissements et notifications..... | 5 |
| Assemblage de la plate-forme..... | 6 |
| Assemblage des fermes..... | 11 |
| Assemblage des pignons..... | 16 |
| Assemblage des portes..... | 21 |
| Assemblage du plancher..... | 30 |
| Assemblage des murs..... | 34 |
| Identificateur de pièces..... | 37 |
| Installation du rayonnage..... | 43 |
| Installation des portes..... | 46 |
| Assemblage du toit..... | 50 |
| Installation des carreaux..... | 60 |
| Installation des crochets muraux..... | 63 |
| Alignement des portes..... | 65 |
| L'ancrage de l'abri..... | 68 |
| Nettoyage et entretien..... | 71 |
| Enregistrement..... | 72 |
| Garantie..... | 74 |

QUESTIONS ?

Composer le **1-800-225-3865**

Du lundi au vendredi 7 h – 17 h (HNR)
et samedi 9 h – 13 h (HNR)

web: www.lifetime.com/customerservice

(Cliquer sur la languette « LIVE CHAT »)

Pour les services à la clientèle du continent européen :

É-mail : cs@lifetimeproducts.eu

CONTACTER NOS SERVICES À LA CLIENTÈLE :

MODÈLE ET RÉFÉRENCE DU PRODUIT (il faut avoir les deux au moment de nous contacter)

Número de modèle : **60356**

Référence du produit :



INSTRUCCIONES DE ENSAMBLE

For English, see page 1. Pour le français, voir la page 2.

CASETA EXTERIOR DE 2,44 x 3,81m

MODELO n° 60356

ANTES DE ENSAMBLAR:

- Ensamblar sobre una plataforma nivelada
- Recomendamos, al menos, 3 adultos para el ensamble
- Inspeccionar todas las piezas y el herraje. Verificar que todos están incluidos usando el *Identificador de piezas* en el medio de estas instrucciones. Se puede quitar el *Identificador de piezas*, en amarillo, de las instrucciones para referencia rápida

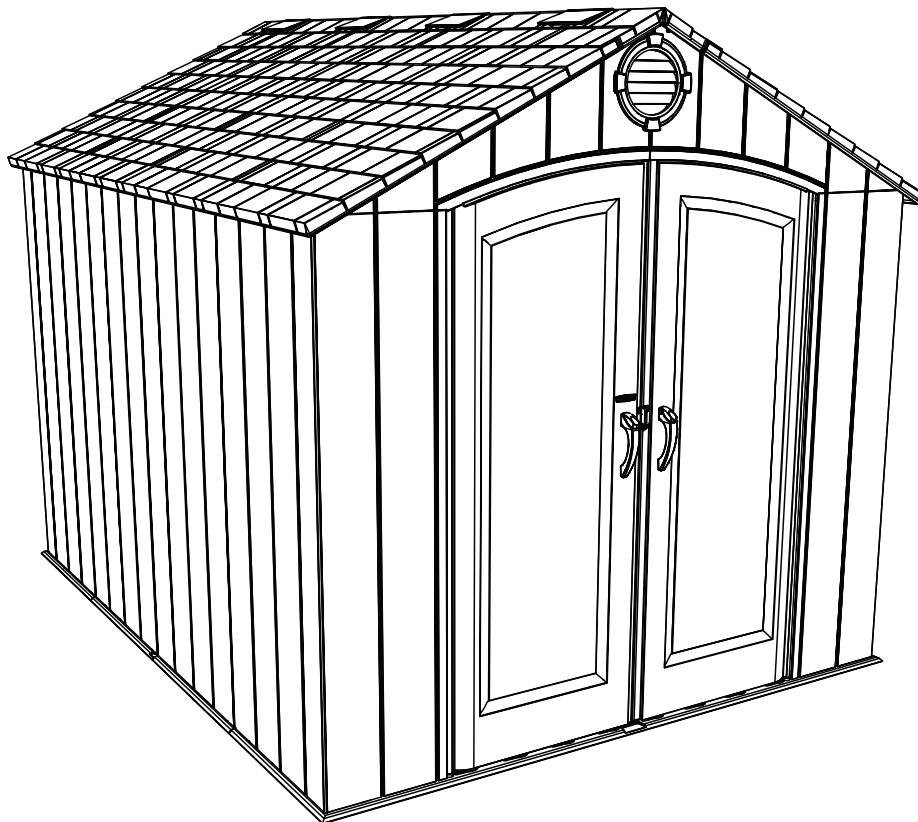

INSTRUMENTAL REQUERIDO



ÍNDICE

| | |
|---------------------------------------|----|
| Legenda de íconos..... | 4 |
| Advertencias y noticias..... | 5 |
| Ensamble de la plataforma..... | 6 |
| Ensamble de las cerchas..... | 11 |
| Ensamble de las fachadas..... | 16 |
| Ensamble de las puertas..... | 20 |
| Ensamble del piso..... | 30 |
| Ensamble de los muros..... | 34 |
| Identificador de piezas..... | 37 |
| Instalación de la estantería..... | 43 |
| Instalación de las puertas..... | 46 |
| Ensamble del tejado..... | 50 |
| Instalación de las hojas de ventana.. | 60 |
| Instalación de los ganchos murales.. | 63 |
| Alineación de la puertas..... | 65 |
| Anclaje de la caseta..... | 68 |
| Limpieza y cuidado..... | 71 |
| Registro..... | 72 |
| Garantía..... | 75 |

¿PREGUNTAS?

Marcar al **1.800.225.3865**
De lunes hasta viernes 7 h–17 h (HNR)
y sábado 9 h–13 h (HNR)

PONERSE EN CONTACTO CON NUESTRO SERVICIO A CLIENTES:

Web: www.lifetime.com/customerservice
(Clicar en la lengüeta "LIVE CHAT")
Para el servicio a clientes en el continente europeo:
Correo electrónico: cs@lifetimeproducts.eu

MODELO E ID DEL PRODUCTO (se necesitan los dos al contactarnos)
Número de modelo: **60356**
ID del producto:



ICON LEGEND / LÉGENDE DES ICÔNES / SIGNIFICADO DE LOS ÍCONOS



- Indicates special heed should be taken when reading.
- Indique qu'une attention spéciale doit être portée à la lecture.
- Indica que uno debe prestar atención al leer.



- Indicates the parts to be used for a section.
- Indique les pièces à utiliser pour une section.
- Indica las piezas que se usarán para una sección.



- Indicates no parts required for a specific section.
- Indique qu'aucune pièce n'est requise pour une section précise.
- Indica que no se necesitan piezas en una sección específica.



- Indicates the hardware to be used for a section.
- Indique la quincaillerie à utiliser pour une section.
- Indica los artículos de ferretería que se usarán para una sección.



- Indicates no hardware required for a specific page.
- Indique qu'aucun matériel n'est requis pour une page précise.
- Indica que no se necesitan los artículos de ferretería para una página específica.



- Indicates the tools to be used for a section.
- Indique les outils à utiliser pour une section.
- Indica las herramientas que se utilizarán para una sección.



- Indicates to use/not to use an electric drill for a specific step.
- Indique quand utiliser ou ne pas utiliser une perceuse électrique pour une étape précise.
- Indica la utilización o no utilización de un taladro eléctrico para un paso específico.



- These nuts are centerlock nuts. They are designed to be tight; therefore, they will be harder to tighten. Tighten until flush with the metal or plastic.
- Ces écrous sont des écrous de blocage central. Ils sont conçus pour être serrés; de ce fait, ils seront plus difficiles à resserrer. Serrer jusqu'à ce qu'ils soient au ras du métal ou du plastique.
- Estas tuercas son tuercas de bloqueo central. Están diseñadas para estar apretadas; por lo tanto, serán más difíciles de apretar. Apriételas hasta que estén al ras del metal o plástico.



WARNINGS & NOTICES / AVERTISSEMENTS ET AVIS / ADVERTENCIAS Y AVISOS

English:

- **Failure to follow these warnings may result in serious injury or property damage and will void warranty.**
- To ensure safety, do not attempt to assemble this product without following the instructions carefully.
- Consult all local building codes to verify if the shed requires a building permit.
- Verify the foundation is completely level before assembling the shed.
- Be aware that plastic pieces can be damaged by overtightening the screws. To avoid damage, we strongly recommend the use of a drill with a low torque setting. A #2 Phillips screwdriver may also be used.
- Three capable adults are required for assembly.
- All who participate in the assembly process should wear safety glasses throughout the assembly.
- If using a ladder during assembly, use extreme caution.
-  In heavy snowfall areas, we recommend removing snow from the roof. Remove the snow from the roof when the depth of snow equals the length of your hand.
- Do not use or store hot objects near the product.
- Proper and complete assembly are essential to reduce the risk of accident or injury.
- When drilling through metal, beware of burrs, shavings and other sharp edges.
- During and after assembly, do not slide or lift the shed by pushing up on the roof. Move the shed by pushing on the corner panels only.
- We strongly recommend anchoring your shed when it is finished. The last section, *Shed Anchoring*, in this manual shows the hardware you will need to complete the anchoring. You can find the hardware at your local hardware store.
- **Most injuries are caused by misuse and/or not following instructions. Use caution when using this product.**

Français :

- **Ne pas suivre ces avertissements peut entraîner des blessures graves ou des dommages à la propriété et annulera la garantie.**
- Afin d'assurer la sécurité, ne pas tenter d'assembler ce produit sans suivre attentivement les instructions.
- Consulter tous les codes du bâtiment afin de vérifier si l'abri nécessite un permis de construire.
- Vérifier que la fondation est complètement à niveau avant l'assemblage de l'abri.
- Ne pas oublier que les pièces de plastique peuvent être endommagées en serrant trop les vis. Afin d'éviter les dommages, nous recommandons fortement l'utilisation d'une perceuse à faible couple. Un tournevis cruciforme n° 2 peut aussi être utilisé.
- Trois adultes en bonne condition physique sont nécessaires pour l'assemblage.
- Tout ceux qui participent au processus de l'assemblage doivent porter des lunettes de sécurité tout au long de l'assemblage.
- Si une échelle est utilisée pour l'assemblage, il faut être extrêmement prudent.
-  Dans les zones de fortes tombées de neige, il est recommandé de dégager le toit. Enlever la neige du toit quand la profondeur est égale à la longueur de la main.
- Ne pas utiliser ou entreposer des objets très chauds près de ce produit.
- Un bon assemblage complet est nécessaire pour réduire le risque d'accident ou de blessure.
- En perçant le métal, faire attention aux bavures, copeaux et autre bords aiguisés.
- Pendant et après l'assemblage, ne pas faire glisser ou soulever l'abri en poussant le toit vers le haut. Déplacer l'abri en poussant les panneaux muraux angulaires seulement.
- Il est fortement recommandé d'ancrer l'abri lorsque l'assemblage est terminé. La dernière section, *Ancrage de l'abri*, de ce manuel indique les matériaux nécessaires pour l'ancrage. Les matériaux se trouvent dans la quincaillerie locale.
- **La majorité des blessures sont causées par une mauvaise utilisation et/ou le non suivi des instructions. Être prudent en utilisant ce produit.**

Español:

- **No seguir estas advertencias puede resultar en lesiones graves o daños a la propiedad y anulará la garantía.**
- A fin de garantizar la seguridad, no intentar ensamblar este producto sin seguir cuidadosamente las instrucciones.
- Consultar todos los códigos de construcción locales para verificar si la caseta requiere un permiso de construcción.
- Verificar que el concreto esté nivelado completamente antes de ensamblar la caseta.
- Tener en cuenta que las piezas de plástico pueden dañarse si los tornillos se aprietan de más. A fin de evitar daños, lo exhortamos a que use un taladro con función de torque bajo. También puede usarse un desatornillador Phillips no. 2.
- Se necesitan tres adultos para el ensamble.
- Todos los que participen en el proceso de ensamble debe usar anteojos de seguridad durante todo el ensamble.
- Si se usa una escalera durante el ensamblado, es preciso tener cuidado.
-  En áreas de nevadas fuertes, recomendamos retirar la nieve del techo. Quitar la nieve del tejado cuando la profundidad de ella es igual a la longitud de la mano.
- No usar ni guardar objetos calientes cerca del producto.
- El ensamblaje correcto y completo son esenciales para reducir el riesgo de accidente o lesión.
- Al perforar metal, tenga cuidado las rebabas, virutas y otros bordes afilados.
- Durante y después del ensamblaje, no deslizar ni levantar la caseta par empujar en el tejado. Mover la caseta par empujar los paneles murales angulares solamente.
- Lo exhortamos a anclar la caseta al terminar el ensamble. La última sección, *Anclaje de la caseta*, en este manual muestra el herraje necesaria para terminar el anclaje. Se encuentra el herraje en la ferretería local.
- **La mayoría de las lesiones suceden a causa del mal uso y/o por no seguir las instrucciones. Tener precaución al usar este producto.**

1

PLATFORM CONSTRUCTION / CONSTRUCTION DE LA PLATE-FORME / CONSTRUCCIÓN DE LA PLATAFORMA



• You must provide a platform on which to assemble your shed. Proper building permit documentation may be required in your neighborhood. Consult all local building codes prior to assembling the shed. Before beginning assembly, you must pour or construct a platform. There are two types:

- Concrete
- Wood Frame

Select the type, but know the surface must be leveled and flat before installation. If the surface is not properly leveled and flat, the shed will not assemble correctly. Proper surface leveling will save you time in the long run, so please do not ignore this step.

We recommend a Concrete platform. It will be the most durable and long-lasting choice. The platform you choose must be built above ground in order to avoid water pooling inside the shed. All lumber must be rated for outdoor use!



• Il faut construire une plate-forme pour l'abri. Il est possible que le quartier exige une documentation visant les permis de construire. Consulter tous les codes du bâtiment locaux, ainsi que les décrets des villes et comtés, pour vérifier que la construction de l'abri extérieur n'exige pas un permis de construire. Avant de commencer l'assemblage, il faut couler ou construire une plate-forme. Il y a deux styles :

- Béton
- Cadre à bois

Sélectionner le style, mais savoir que la surface d'installation doit être de niveau et plate. Si la surface n'est pas correctement de niveau et plate, l'assemblage de l'abri ne se fera pas correctement. Le temps sera épargné à long terme grâce à une surface bien de niveau, ne pas négliger cette étape. **Nous recommandons une plate-forme en Béton. Ce choix sera le plus durable. La plate-forme choisie doit être construite au-dessus du sol afin d'éviter l'accumulation d'eau à l'intérieur de l'abri. Tous le bois d'oeuvre doit être approuvé pour l'usage à l'extérieur !**



• Es preciso construir una plataforma para la caseta. Puede suceder que en el vecindario se requiera la documentación apropiada de un permiso de construcción. Consultar todos los códigos locales de construcción y los reglamentos de la ciudad y el municipio para asegurarse de que la construcción de la caseta no requiere un permiso de construcción. Antes de comenzar el ensamble, es necesario verter o construir una plataforma. Hay dos clases:

- Concreto
- Armazón de madera

Seleccionar la clase, mas sepa que la superficie debe estar nivelada y plana antes de comenzar el ensamble. Si la superficie no está nivelada y plana de manera adecuada, la caseta no podrá ensamblarse correctamente. La nivelación de la superficie le ahorrará tiempo de trabajo, por lo tanto, le pedimos que no ignore este paso. **Recomendamos una plataforma hecho de concreto. Será la elección más perdurable. La plataforma debe ser construida arriba del suelo para evitar el aflujo de agua dentro de la caseta. ¡Toda la madera debe estar clasificada para el uso externo!**

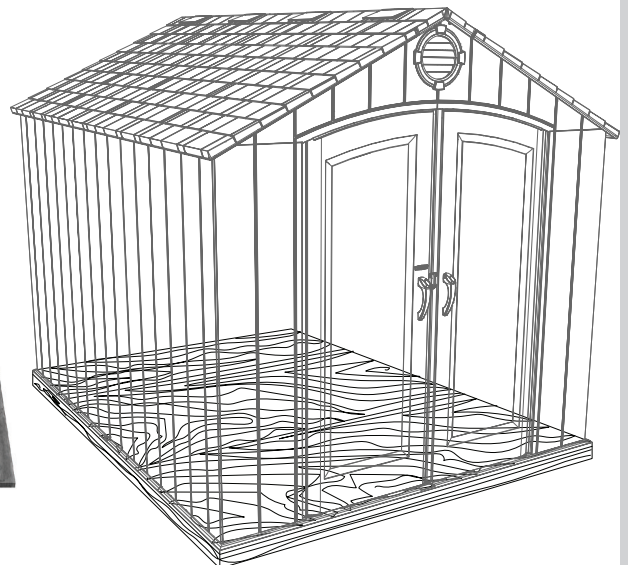
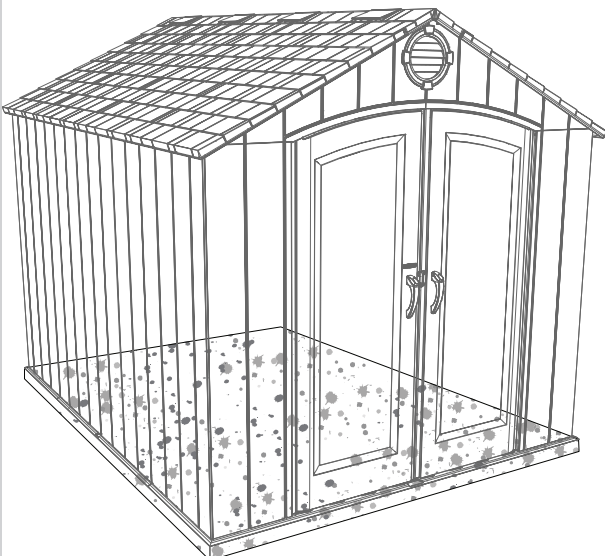

► SECTION 1 (CONTINUED) / SECTION 1 (SUITE) / SECCIÓN 1 (CONTINUACIÓN)

CONCRETE REQUIRED / BÉTON REQUIS / CONCRETO REQUERIDO



2 yd³ (≈1,53 m³)

1.1

CONCRETE PLATFORM / PLATAFORMA DE CONCRETO / PLATE-FORME EN BÉTON

- The concrete should be approximately 4" (≈10 cm) thick. The actual dimensions of the shed, at its widest and longest points, are 96" x 120" (≈2,44 m x 3,05 m). Ensure you select a site that will accommodate these measurements. **The floor dimensions are a bit smaller than those of the roof; therefore, you will need to build a level surface of 93 1/2" x 118 1/4" (≈2,38 m x 3,00 m). These are the measurements of the platform—not the floor.**
- Le béton doit être un épaisseur de ≈10 cm (4 in). Les dimensions réelles de votre abri, aux points les plus large et long, sont ≈2,44 m x 3,05 m (96 in x 120 in). S'assurer de sélectionner un site qui accommodera ces dimensions. **Les dimensions du plancher de votre abri sont plus petites que le toit; ensuite, il faut créer une surface horizontale de ≈2,38 m x 3,00 m (93 1/2 in x 118 1/4 in). Ces mesures sont de la plate-forme — non le plancher.**
- El concreto debe tener, por lo menos, ≈10 cm (4 po) de espesor. Las dimensiones reales de la caseta, a sus puntos más ancho y largo, son ≈2,44 m x 3,05 m (96 po x 120 po). Asegurarse de seleccionar un sitio que acomodará estas medidas. **Las dimensiones del piso de la caseta son más pequeñas que el tejado; entonces, se necesita crear una superficie nivelada de ≈2,38 m x 3,00 m (93 1/2 po x 118 1/4 po). Estas medidas son las de la plataforma, no el piso.**

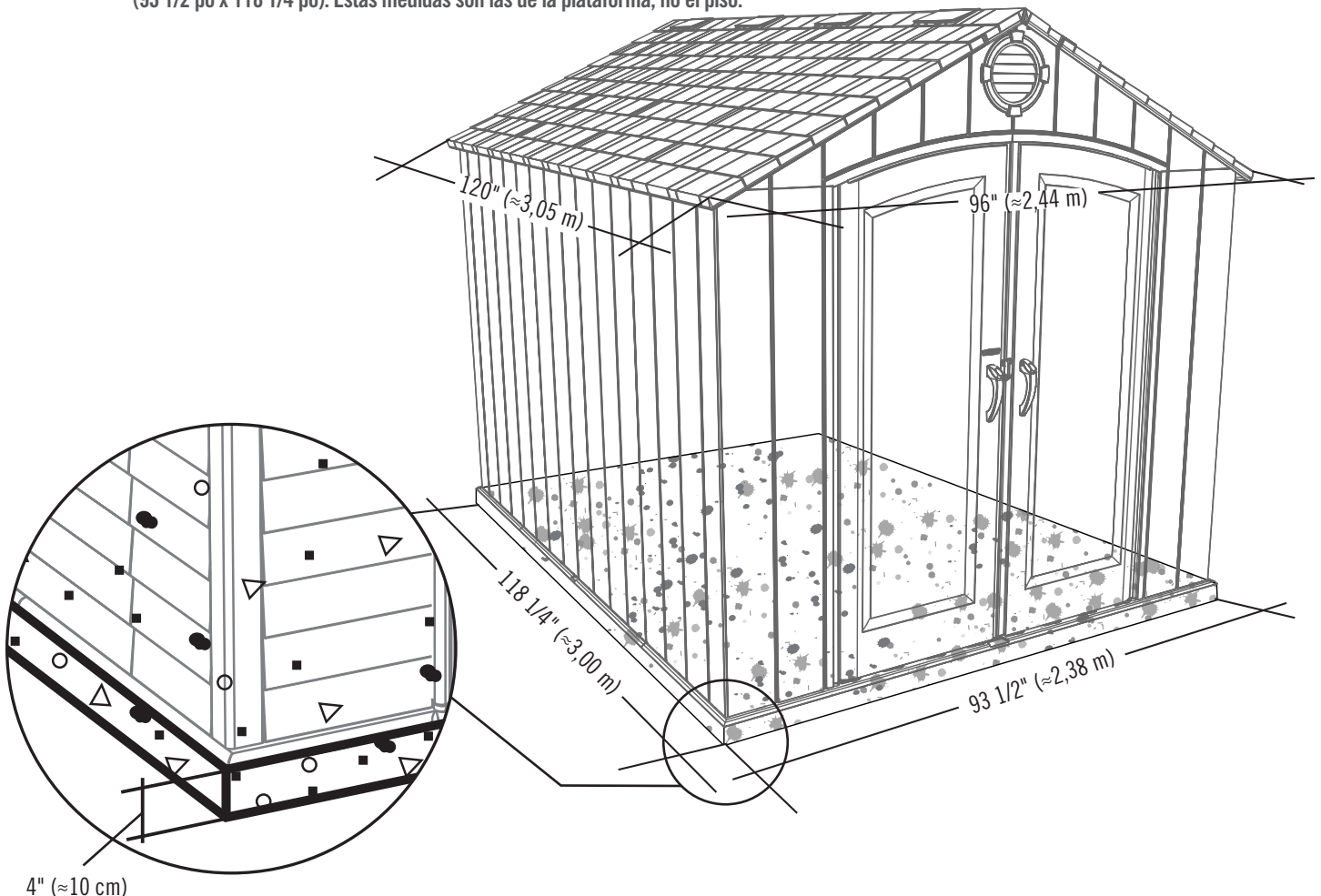

4" (≈10 cm)

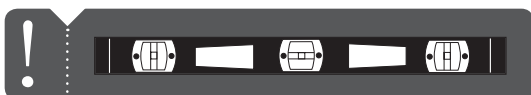

► SECTION 1 (CONTINUED) / SECTION 1 (SUITE) / SECCIÓN 1 (CONTINUACIÓN)

WOOD REQUIRED / BOIS REQUIS / MADERA REQUERIDA



1.2

WOOD PLATFORM / PLATE-FORME EN BOIS / PLATAFORMA DE MADERA

- The actual dimensions of the shed, at its widest and longest points, are 96" x 120" ($\approx 2,44$ m x 3,05 m). Ensure you select a site that will accommodate these measurements. **The floor dimensions are a bit smaller than those of the roof; therefore, you will need to build a level surface of 93 1/2" x 118 1/4" ($\approx 2,38$ m x 3,00 m). These are the measurements of the platform—not the floor.**
- Les dimensions réelles de l'abri, aux points les plus large et long, sont $\approx 2,44$ m x 3,05 m (96 x 120 po). S'assurer de sélectionner un site qui accommodera ces dimensions. **Les dimensions du plancher de votre abri sont plus petites que le toit; ensuite, il faut créer une surface horizontale de $\approx 2,38$ m x 3,00 m (93 1/2 x 118 1/4 po). Ces mesures sont de la plate-forme — non le plancher.**
- Las dimensiones reales de la caseta, a sus puntos más ancho y largo, son $\approx 2,44$ m x 3,05 m (96 in x 120 in). Asegurarse de seleccionar un sitio que acomodará estas medidas. **Las dimensiones del piso de la caseta son más pequeñas que el tejado; entonces, se necesita crear una superficie nivelada de $\approx 2,38$ m x 3,00 m (93 1/2 x 118 1/4 in). Estas medidas son las de la plataforma, no el piso.**

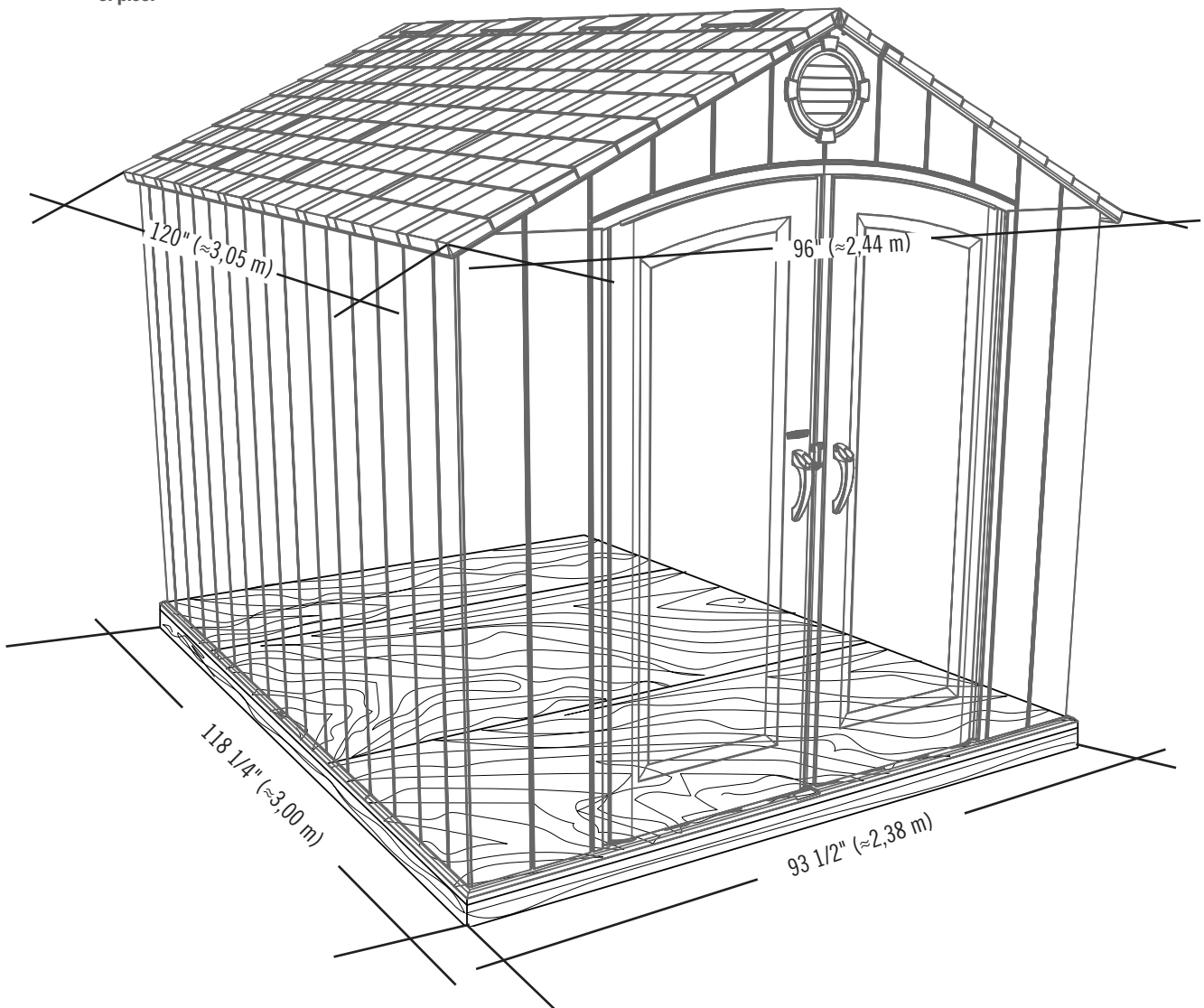

► SECTION 1 (CONTINUED) / SECTION 1 (SUITE) / SECCIÓN 1 (CONTINUACIÓN)

TOOLS, PARTS, AND HARDWARE REQUIRED / OUTILS, PIÈCES, ET QUINCAILLERIE REQUIS / INSTRUMENTAL, PIEZAS, Y HERRAJE REQUERIDOS

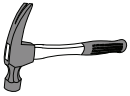

2 in/po x 4 in/po x 118 1/4 in/po (≈5,0 cm x 10,0 cm x 3,00 m) (x2)



2 in/po x 4 in/po x 90 1/2 in/po (≈5,0 cm x 10,0 cm x 2,30 m) (x9)

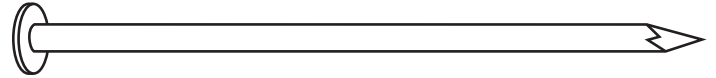

16d 3 1/2 in/po (≈16d x 8,9 cm) (x36)

1.2.1

WOOD PLATFORM / PLATE-FORME EN BOIS / PLATAFORMA DE MADERA

- Ensure all lumber is treated and approved for outdoor use. Build frame to 93 1/2" x 118 1/4" (≈2,4 m x 3,0 m) (**outside dimensions**).
- Vérifier que votre bois d'œuvre à été traité et approuvé pour l'utilisation à l'extérieur. Construire un cadre de 2,4 m x 3,0 m (≈93 1/2 po x 118 1/4 po) (**dimensions extérieures**).
- Asegurarse de usar madera tratada y aprobada para el uso externo. Construir el armazón a 2,4 m x 3,0 m (≈93 1/2 in x 118 1/4 in) (**dimensiones exteriores**).

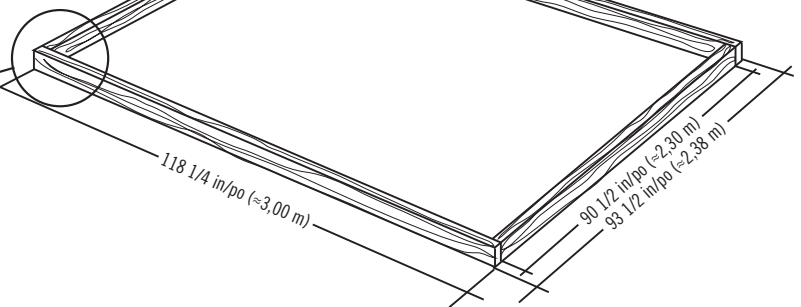
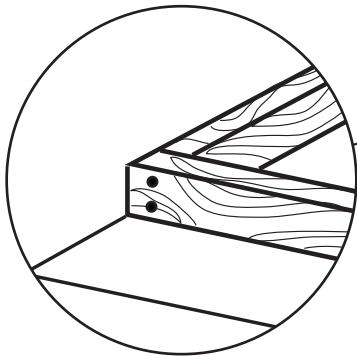
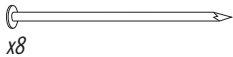

1.2.2

- To ensure studs are in the correct location for nailing plywood in the next step, start measuring from the corner 16" (≈40,1 cm), and then measure from center to center.
- Pour être sûr d'avoir assez de montant pour clouer le contreplaqué dans la prochaine étape, commencer à mesurer à partir de cette montant ≈40,1 cm (16 po) vers le centre du deuxième montant. Ensuite, mesurer de centre à centre pour les montants restants.
- Para asegurarse que los montantes están en las ubicaciones correctas para el contrachapado en el paso siguiente, comenzar a medir desde el borde del montante hasta el centro del próximo montante ≈40,1 cm (16 in). Luego, tomar la medida de centro a centro en los montantes restantes.

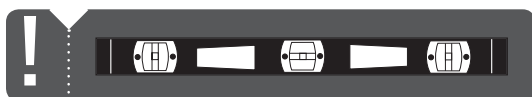
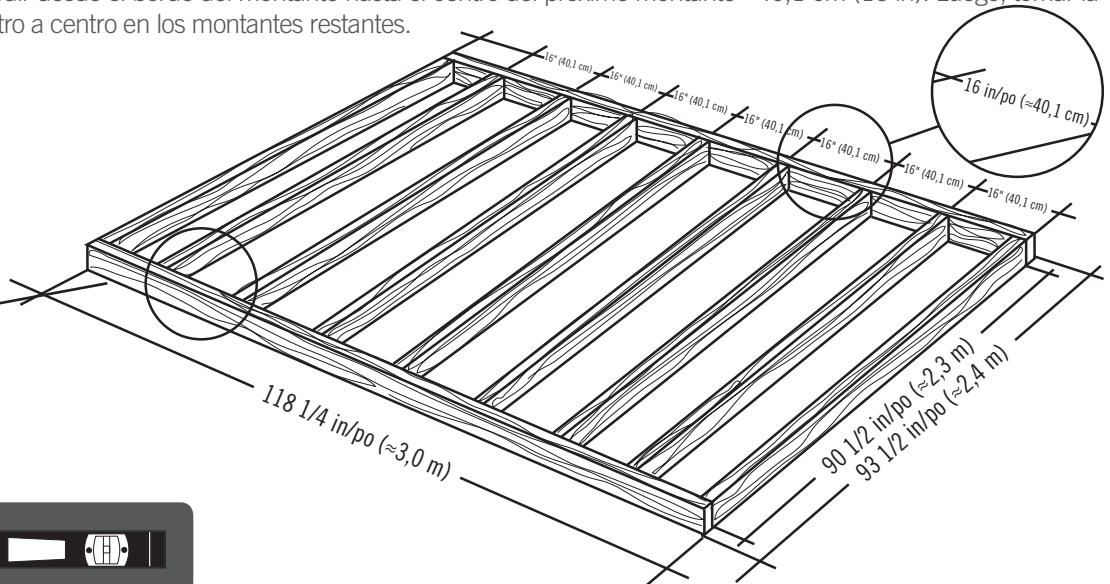
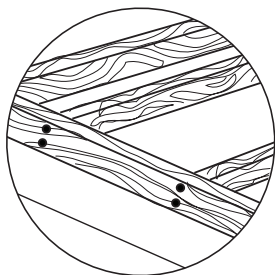

► SECTION 1 (CONTINUED) / SECTION 1 (SUITE) / SECCIÓN 1 (CONTINUACIÓN)

TOOLS, PARTS, AND HARDWARE REQUIRED / OUTILS, PIÈCES, ET QUINCAILLERIE REQUIS / INSTRUMENTAL, PIEZAS, Y HERRAJE REQUERIDOS

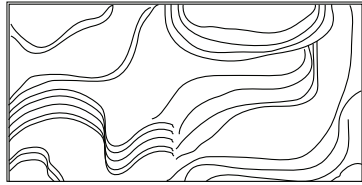
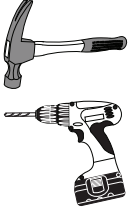

48 in/po x 93 1/2 in/po x 3/4 in/po
(≈1,25 m x 2,4 m x 19 mm) (x2)



22 1/4 in/po x 93 1/2 in/po x 3/4 in/po
(≈57 cm x 2,4 m x 19 mm) (x1)

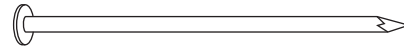

8d 2 in/po (≈8d 5 cm) (x66)

1.2.3

- Square the frame, measuring from corner to corner. **Measurement A & B should be about the same length.**
- Carrer le cadre en mesurant d'angle à angle. **La mesure « A » et « B » doivent être à peu près la même longueur.**
- Cuadrar el armazón mediendo de esquina a esquina. **La medida "A" y "B" deben ser aproximadamente el mismo largo.**

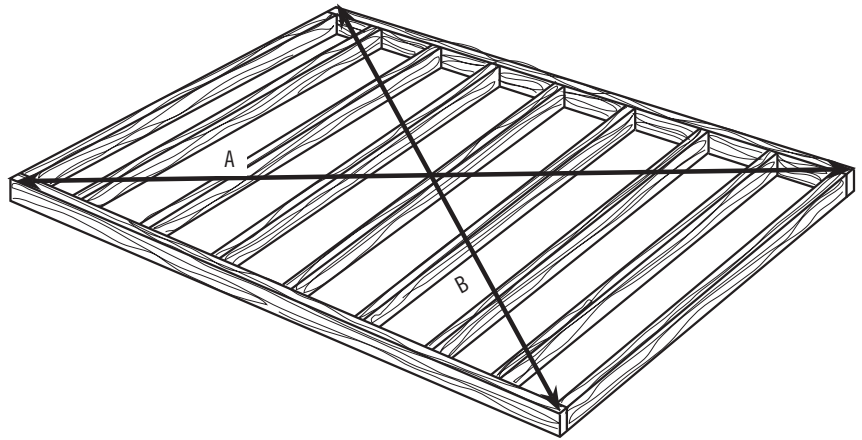

! A = B

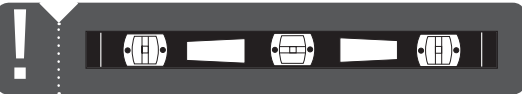

1.2.4

- Using nails, fasten the plywood to the frame. Then, drill 5/16" (≈8 mm) holes for drainage.
- En utilisant des clous, attacher bien le contreplaqué au cadre. Ensuite, percer des trous de ≈8 mm pour le drainage.
- Usando unos clavos, sujetar el contrachapado al armazón. Entonces, taladrar agujeros de ≈8 mm para el drenaje.

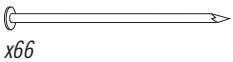

x66

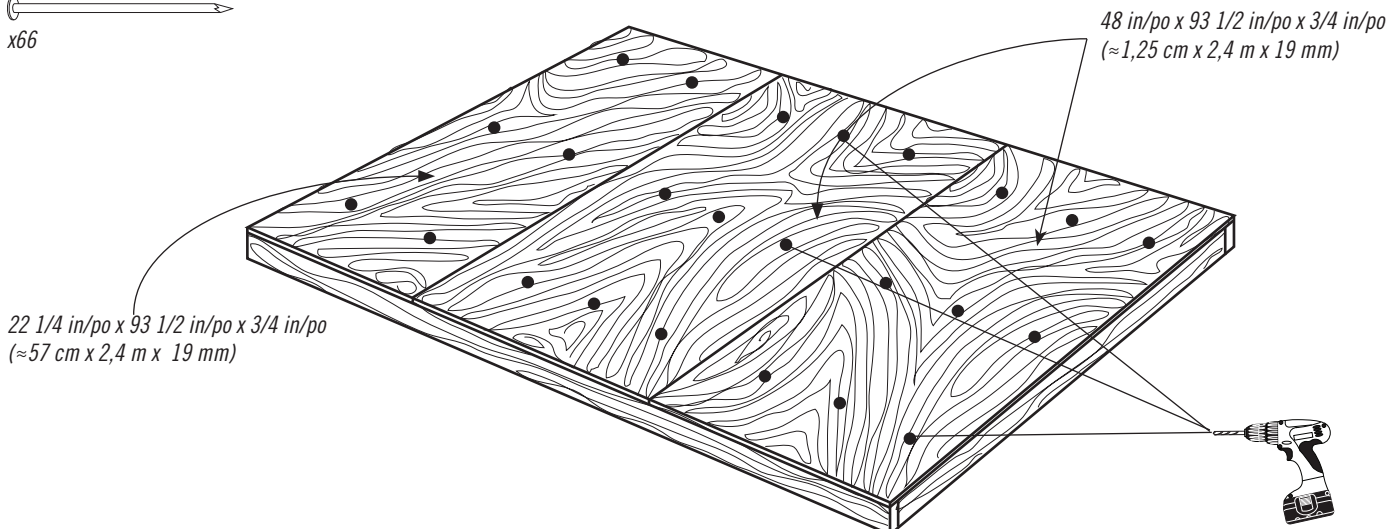

22 1/4 in/po x 93 1/2 in/po x 3/4 in/po
(≈57 cm x 2,4 m x 19 mm)

48 in/po x 93 1/2 in/po x 3/4 in/po
(≈1,25 cm x 2,4 m x 19 mm)

Drainage Holes
Trous de drainage
Agujeros para canalización

x24!

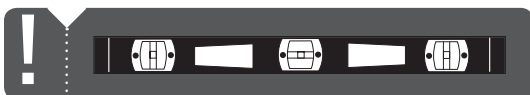

2

TRUSS ASSEMBLY / ASSEMBLAGE DES FERMES / ENSAMBLE DE LAS CERCHAS



HARDWARE REQUIRED / QUINCAILLERIE REQUISE / HERRAJE REQUERIDO

Hardware Bag / Sac de quincaillerie / Bolsa de herraje



DTK (x12)



ADJ (x6)

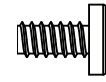

ADY (x12)



ADK (x24)

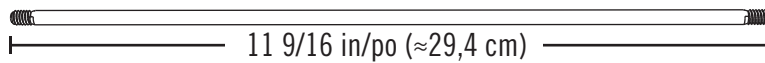

11 9/16 in/po (≈29,4 cm)

ADH (x3)



PARTS REQUIRED / PIÈCES REQUISES / PIEZAS REQUERIDAS

Metal Parts / Pièces en métal / Piezas de metal



50 9/16 in/po (≈1,28 m)

DSR (x6)

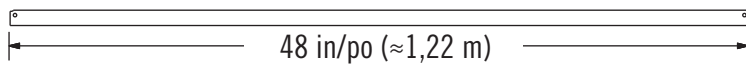

48 in/po (≈1,22 m)

AFG (x3)

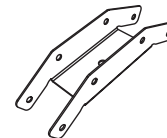
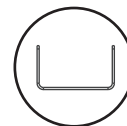

AIP (x3)

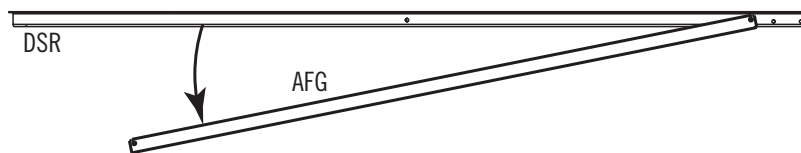

- Sometimes during shipping, the Truss Brace (AFG) slides over the back of the Gutter Channel (DSR). The two pieces are the same colour. If you think you're missing a Truss Brace, check to see if it is stuck to the back of the Gutter Channel, and separate the two.
- Durant le transport, parfois le support de ferme (AFG) glisse par-dessus l'arrière du canal de gouttière (DSR). Les deux pièces sont du même couleur. Si un support est manquant, vérifier s'il y a un support de ferme qui adhère à l'arrière du canal de gouttière, et séparer les deux.
- Durante el transporte, a veces el soporte de cercha (AFG) desliza sobre el dorso del canal de cercha (DSR). Las dos piezas son de la misma color. Si le falta un soporte de cercha, verificar si haya un soporte pegado al dorso del canalón de cercha, y separar los dos.



TOOLS REQUIRED / OUTILS REQUIS / INSTRUMENTAL REQUERIDO



7/16 in/po (11 mm) (x2)



3/8 in/po (10 mm)



3/8 in/po (10 mm)

► SECTION 2 (CONTINUED) / SECTION 2 (SUITE) / SECCIÓN 2 (CONTINUACIÓN)

TOOLS AND HARDWARE REQUIRED / OUTILS ET QUINCAILLERIE REQUIS / INSTRUMENTAL Y HERRAJE REQUERIDOS

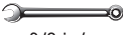

3/8 in/po
(10 mm)



DTK (x12)



ADK (x12)

2.1

- Slide a **Connector (AIP)** onto the ends of two **Truss Gutter Channels (DSR)** as shown.
- Faire glisser un **raccord (AIP)** sur les extrémités des **canaux de gouttière (DSR)** comme illustré.
- Deslizar un **connector (AIP)** en los extremos de los **canalones de cercha (DRS)** como se muestra.

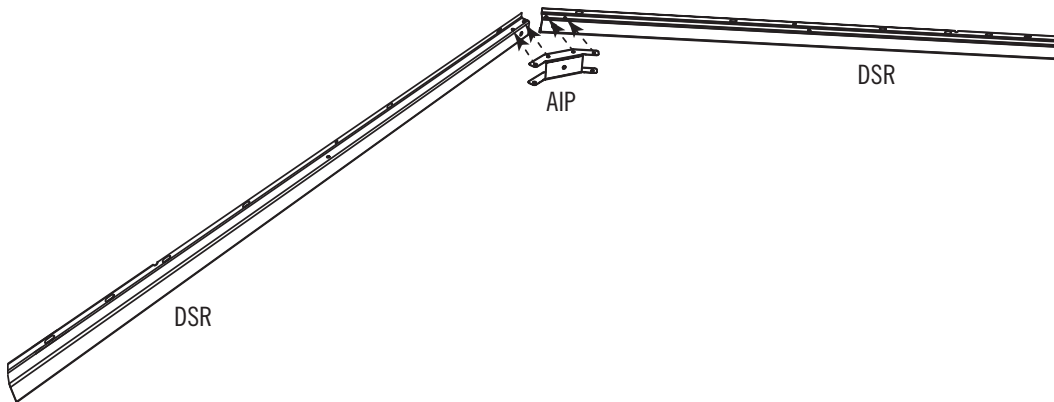

2.2

- Attach the **Connector** using the hardware indicated. **Do not overtighten the Cap Nuts.**
- Attacher le **raccord (AIP)** à l'aide de la quincaillerie indiquée. **Ne pas serrer excessivement les écrous borgnes.**
- Sujetar el **connector (AIP)** usando el herraje indicado. **No apretar demasiado las tuercas ciegas.**

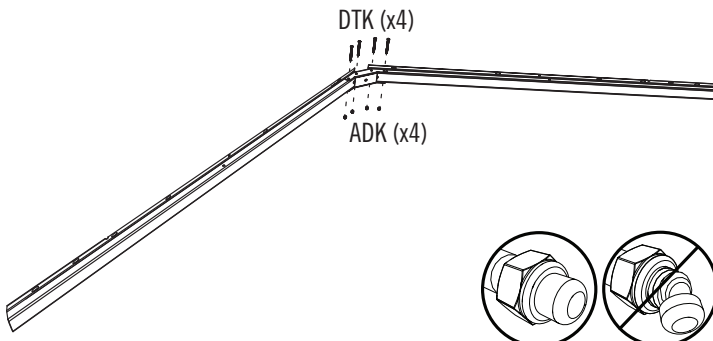

2.3

- Slide a **Truss Brace (AFG)** onto the Truss Gutter Channels as shown, and align the holes.
- Faire glisser un **support de ferme (AFG)** sur les canaux de gouttière comme illustré, et aligner les trous.
- Deslizar un **soporte de cercha (AFG)** sobre los canalones de cercha como se muestra, y alinear los agujeros.

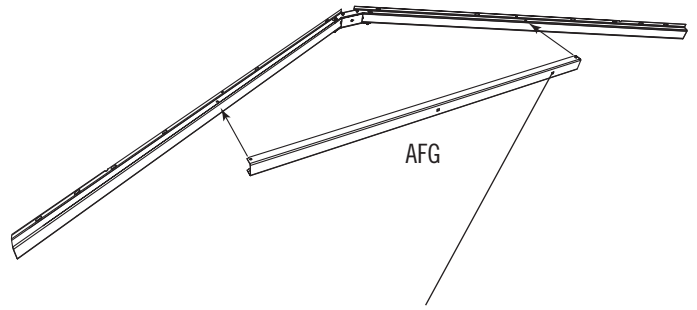

- *This square hole is for manufacturing purposes only.*
- *Ce trou carré est pour la seule fin de la fabrication.*
- *Este agujero cuadrado sirve sólo para los fines de fabricación.*

► SECTION 2 (CONTINUED) / SECTION 2 (SUITE) / SECCIÓN 2 (CONTINUACIÓN)

TOOLS AND HARDWARE REQUIRED / OUTILS ET QUINCAILLERIE REQUIS / INSTRUMENTAL Y HERRAJE REQUERIDOS



3/8 in/po
(10 mm)

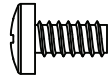

ADY (x12)



ADK (x12)

2.4

- Attach the Truss Brace using the hardware included. **The Cap nuts go on the outside of the Truss. Do not overtighten the Cap Nuts.**
- Attacher le support de ferme à l'aide de la quincaillerie incluse. **Les écrous borgnes vont à l'extérieur de la ferme. Ne pas serrer excessivement les écrous borgnes.**
- Sujetar el soporte de cercha usando el herraje incluido. **Las tuercas ciegas van al exterior de la cercha. No apretar demasiado las tuercas ciegas.**

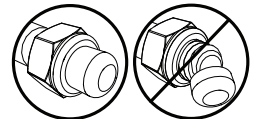
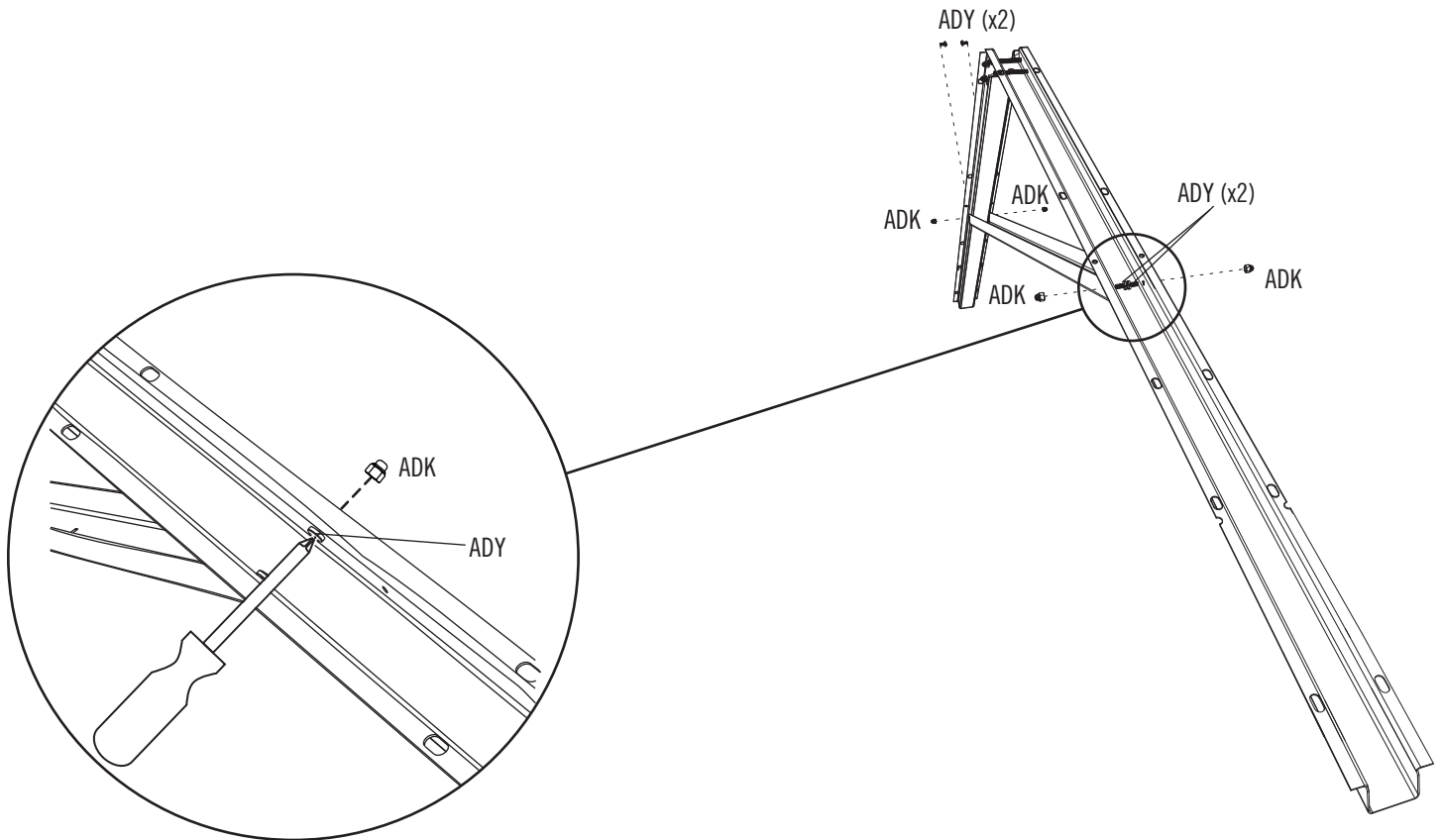

► SECTION 2 (CONTINUED) / SECTION 2 (SUITE) / SECCIÓN 2 (CONTINUACIÓN)

TOOLS AND HARDWARE REQUIRED / OUTILS ET QUINCAILLERIE REQUIS / INSTRUMENTAL Y HERRAJE REQUERIDOS



7/16 in/po (x2)
(11 mm) (x2)



ADJ (x6)

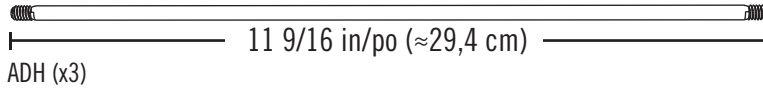

ADH (x3)

2.5

- Slide a **Truss Rod (ADH)** through the holes in the Truss Brace and Connector. Secure with two **Cap Nuts (ADJ)**. **Do not overtighten the Nuts.**
- Faire glisser une **tige (ADH)** à travers les trous dans le support et le raccord. Bien attacher la tige à l'aide de deux **écrous borgnes (ADJ)**. **Ne pas serrer excessivement les écrous.**
- Deslizar una **varilla (ADH)** a través de los agujeros en el soporte y el conector. Sujetarla con dos **tuercas ciegas (ADJ)**. **No apretar demasiado las tuercas.**

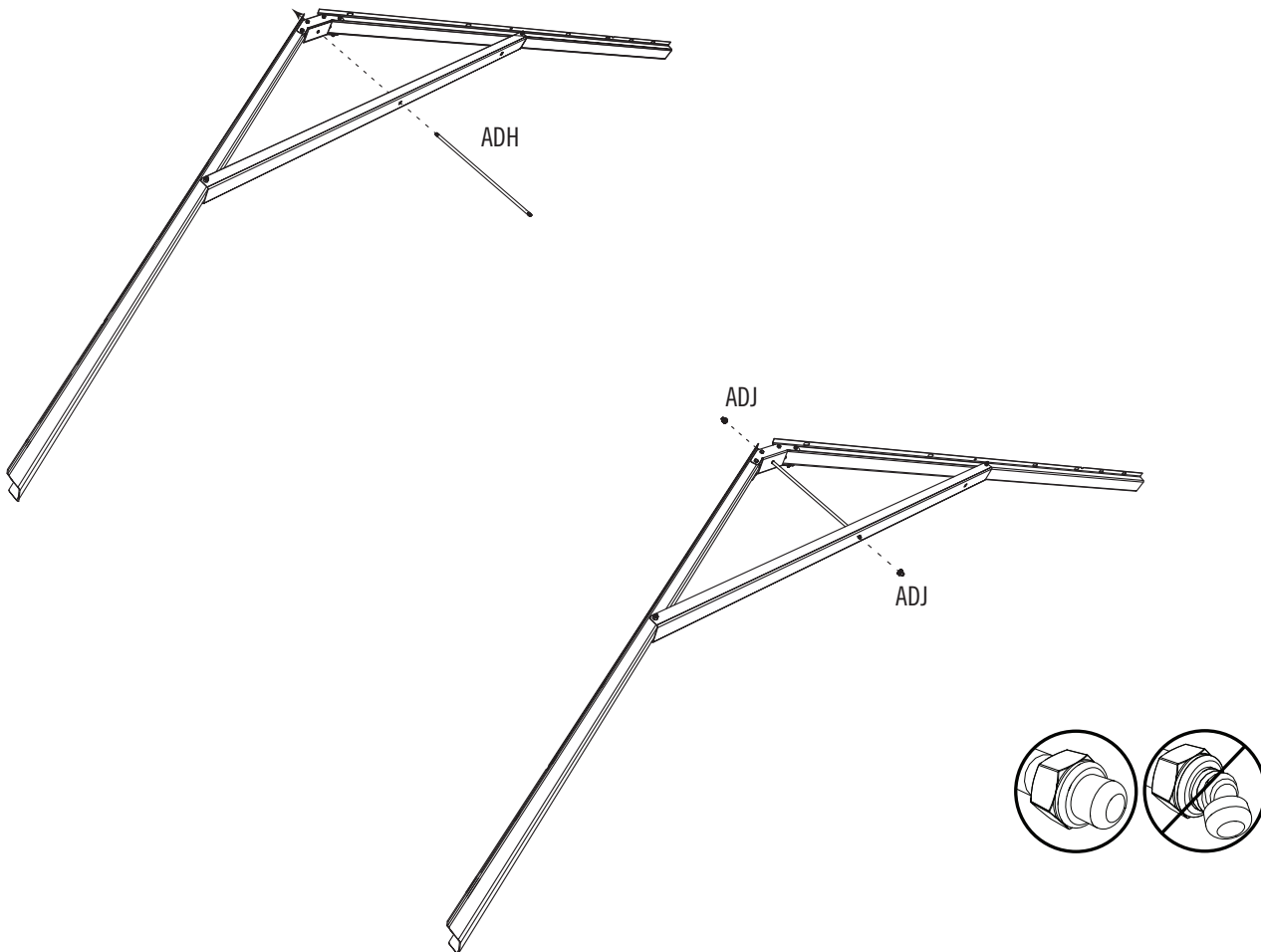

► SECTION 2 (CONTINUED) / SECTION 2 (SUITE) / SECCIÓN 2 (CONTINUACIÓN)

TOOLS AND HARDWARE REQUIRED / OUTILS ET QUINCAILLERIE REQUIS / INSTRUMENTAL Y HERRAJE REQUERIDOS



2.6

- Repeat steps 2.1–2.5 two times.
- Répéter deux fois les étapes 2.1 – 2.5.
- Repetir dos veces los pasos 2.1–2.5.

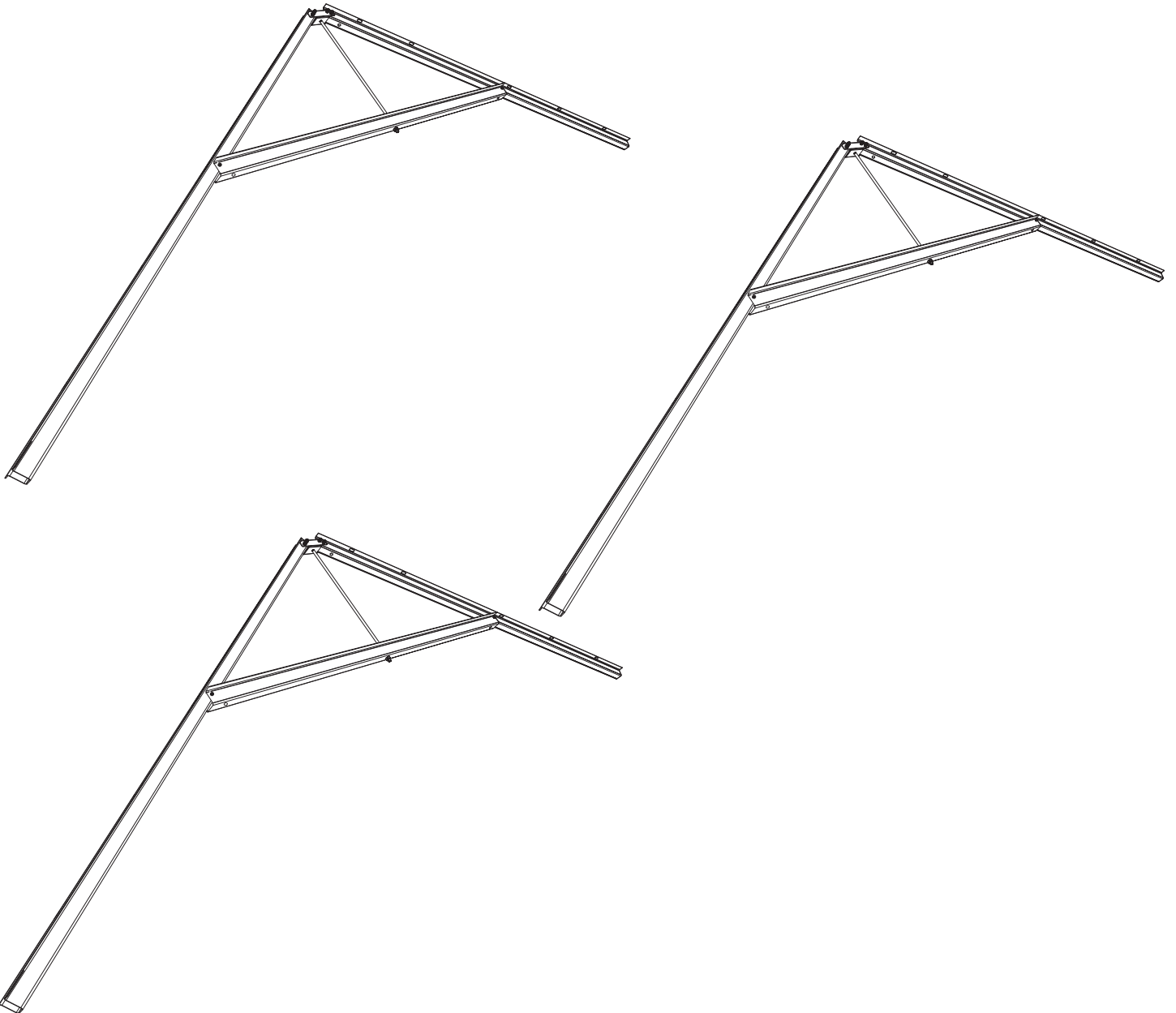

3

GABLE ASSEMBLY / ASSEMBLAGE DES PIGNONS / ENSAMBLAJE DE LAS FACHADAS



HARDWARE REQUIRED / QUINCAILLERIE REQUISE / HERRAJE REQUERIDO

Hardware Bag / Sac de quincaillerie / Bolsa de herraje

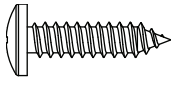

ADW (x10)

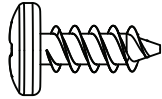

ADZ (x6)

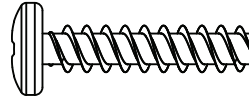

ADV (x12)

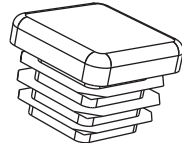

AHS (x4)

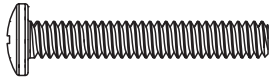

EYR (x2)

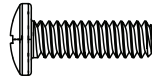

EYQ (x2)



CXK (x2)

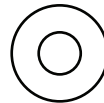

AEE (x14)



ADK (x2)

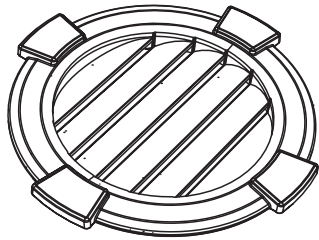

ENH (x2)

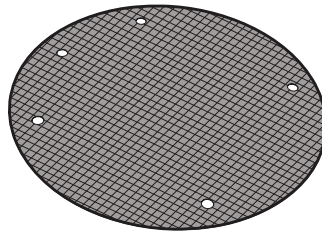

AIQ (x2)



PARTS REQUIRED / PIÈCES REQUISES / PIEZAS REQUERIDAS

Metal Part / Pièce en métal / Pieza de metal



AFE (x1)



EYS (x1)

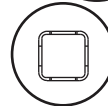
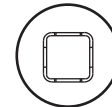

Plastic Parts / Pièces en plastique / Piezas de plástico

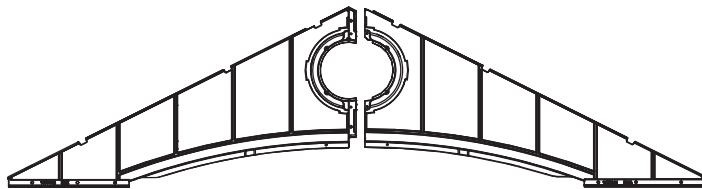

EVZ (x1)

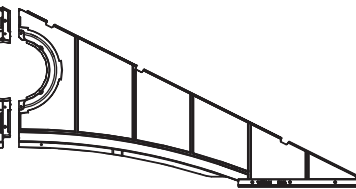

EWA (x1)

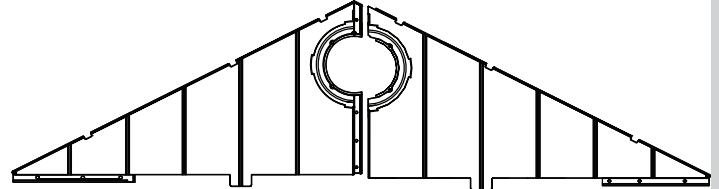

AGI (x1)

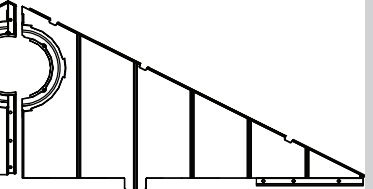

AGH (x1)



TOOLS REQUIRED / OUTILS REQUIS / INSTRUMENTAL REQUERIDO



3/8 in/po (≈10 mm)

► SECTION 3 (CONTINUED) / SECTION 3 (SUITE) / SECCIÓN 3 (CONTINUACIÓN)

TOOLS AND HARDWARE REQUIRED / OUTILS ET QUINCAILLERIE REQUIS / INSTRUMENTAL Y HERRAJE REQUERIDOS

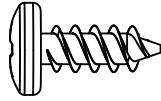

ADZ (x4)

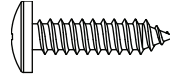

ADW (x5)

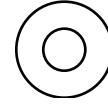

AEE (x5)

3.1

- Align the holes in the **left (AGH)** and **right (AGI)** rear gable halves.
- Aligner les trous dans les **demis pignons gauche (AGH)** et **droit (AGI)**.
- Alinear los agujeros en las **mitades de la fachada trasera izquierda (AGH)** y **derecha (AGI)**.

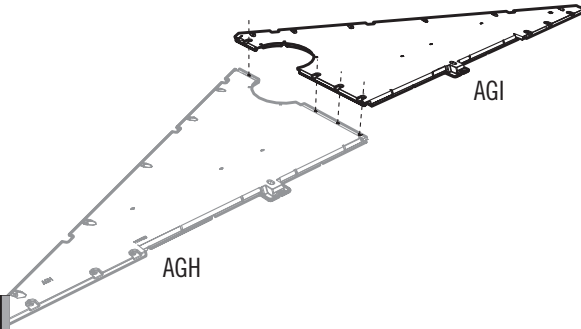

3.2

- Secure the two gable halves with four (4) **Screws (ADZ)**.
- Fixer les deux demis pignons à l'aide de quatre (4) **vis (ADZ)**.
- Fijar las dos mitades de la fachada con cuatro (4) **tornillos (ADZ)**.

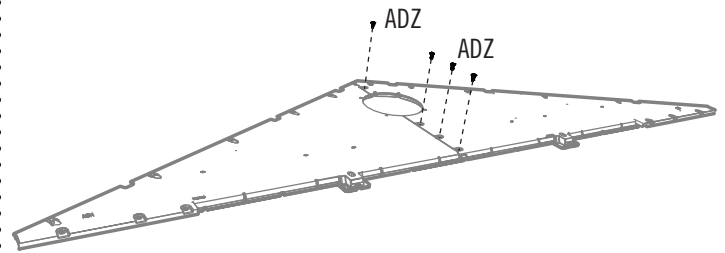

3.3

- Place the **screen (AIQ)** over the **vent (ENH)** and align the five holes in the vent with those in the gable.
- Placer l'**écran (AIQ)** par-dessus l'**évent (ENH)** et aligner les cinq trous dans l'évent avec ceux dans le pignon.
- Colocar el **mosquitero (AIQ)** encima la **rejilla de ventilación (ENH)**, y alinear los cinco agujeros en la rejilla con los de la fachada.

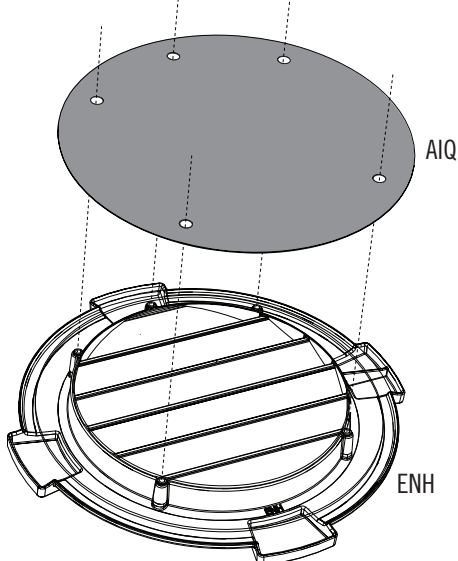

3.4

- Secure them with the hardware included.
- Les fixer à l'aide de la quincaillerie incluse.
- Sujetarlos con el herraje incluido.

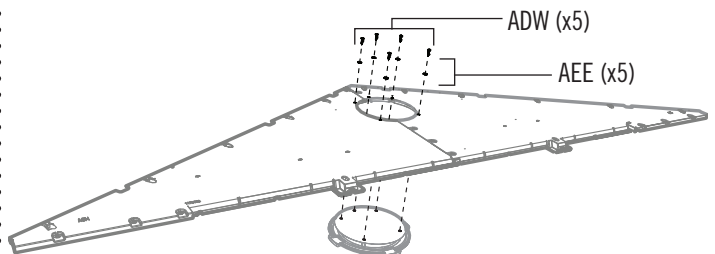

► SECTION 3 (CONTINUED) / SECTION 3 (SUITE) / SECCIÓN 3 (CONTINUACIÓN)

TOOLS AND HARDWARE REQUIRED / OUTILS ET QUINCAILLERIE REQUIS / INSTRUMENTAL Y HERRAJE REQUERIDOS

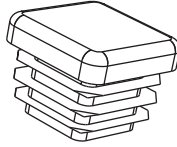

AHS (x2)

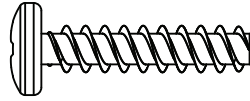

ADV (x6)

3.5

- Insert an **end cap (AHS)** into each end of the **square tube (AFE)**.
- Insérer un **caphuchon (AHS)** dans chaque extrémité de **tube carré (AFE)**.
- Insertar un **tapon (AHS)** en cada extremo del **tubo cuadrado (AFE)**.

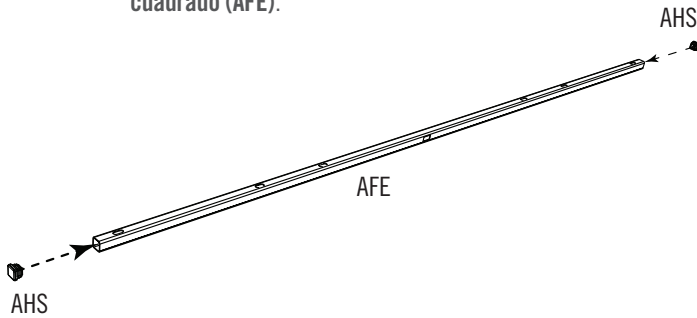

3.6

- Align the holes in the tube with those in the gable.
- Aligner les trous dans le tube avec ceux du pignon.
- Alinear los agujeros en el tubo con ellos en la fachada.

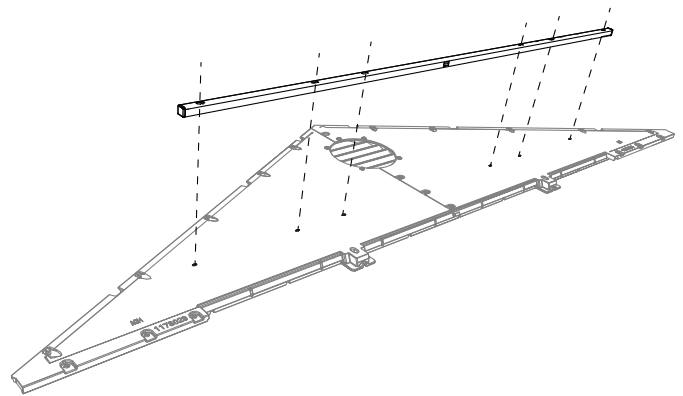

3.7

- Secure with the hardware provided.
- Fixer les uns aux autres en utilisant la quincaillerie incluse.
- Fijar los unos a los otros usando el herraje incluido.

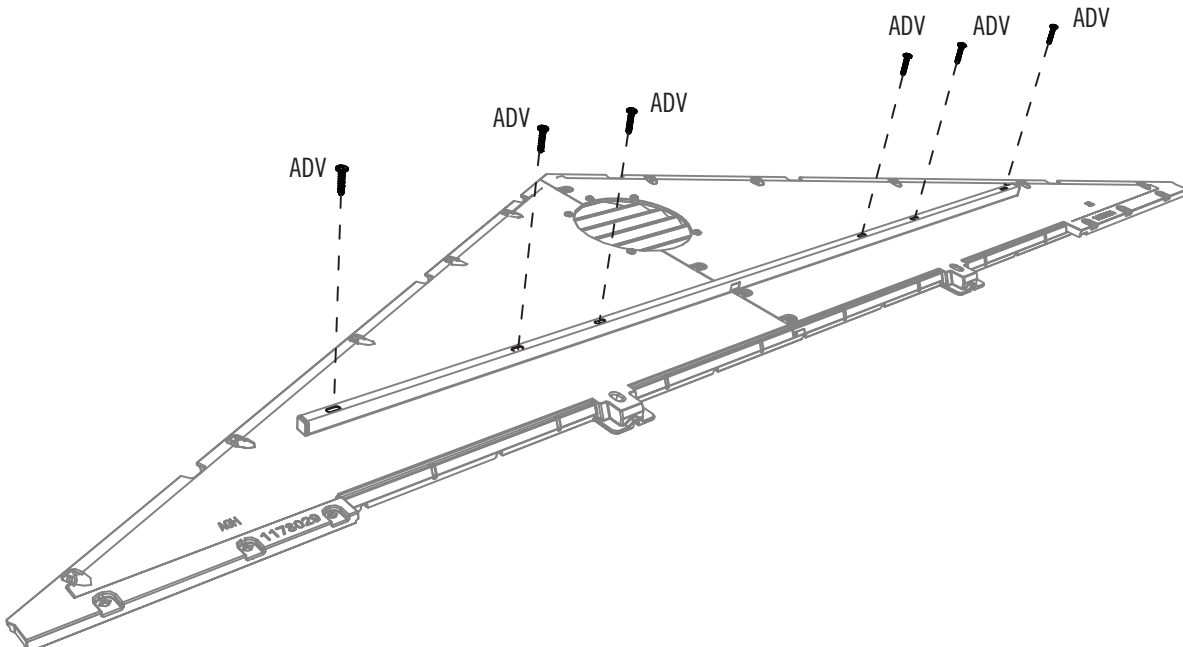

SECTION 3 (CONTINUED) / SECTION 3 (SUITE) / SECCIÓN 3 (CONTINUACIÓN)

TOOLS AND HARDWARE REQUIRED / OUTILS ET QUINCAILLERIE REQUIS / INSTRUMENTAL Y HERRAJE REQUERIDOS



3/8 in/po
(≈10 mm)

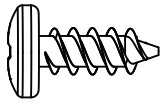

ADZ (x2)

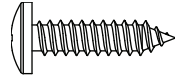

ADW (x5)

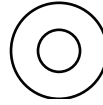

AEE (x7)

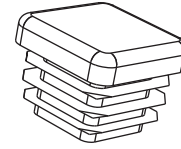

AHS (x2)

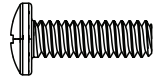

EYQ (x2)



CXK (x2)

3.8

- Align the holes in the **left (EVZ)** and **right (EWA)** entry gable halves.
- Aligner les trous dans les **demis pignons d'entrée gauche (EVZ)** et **droit (EWA)**.
- Alinear los agujeros en las **mitades de la fachada trasera izquierda (EVZ)** y **derecha (EWA)**.

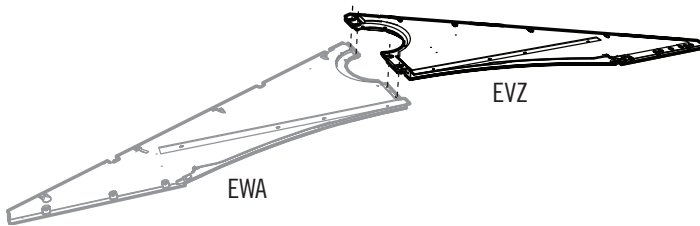

3.9

- Secure with the hardware included.
- Fixer à l'aide de la quincaillerie incluse.
- Sujetar con el herraje incluido.

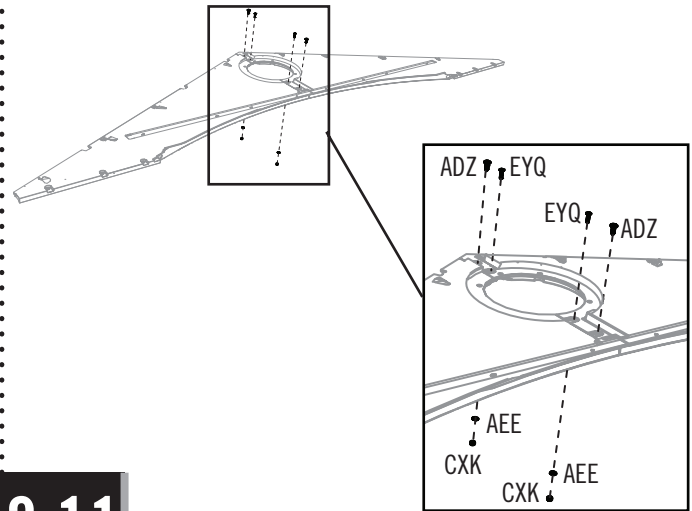

3.10

- Repeat steps 3.3–3.4 for the entry gable.
- Répéter les étapes 3.3 – 3.4 pour le pignon d'entrée.
- Repetir los pasos 3.3–3.4 para la fachada de entrada.

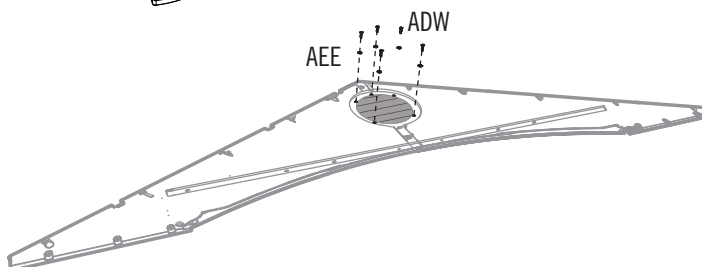
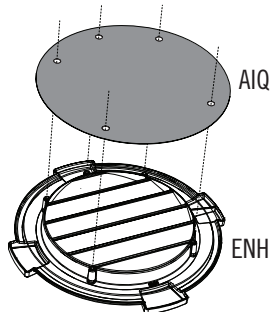

3.11

- Insert an **end Cap (AHS)** into each end of the **header (EYS)**.
- Insérer un **capuchon (AHS)** dans chaque extrémité du **linteau (EYS)**.
- Insertar un **tapón (AHS)** en cada extremo del **dintel (EYS)**.

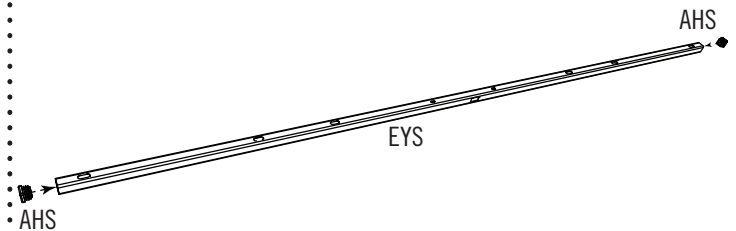

► SECTION 3 (CONTINUED) / SECTION 3 (SUITE) / SECCIÓN 3 (CONTINUACIÓN)

TOOLS AND HARDWARE REQUIRED / OUTILS ET QUINCAILLERIE REQUIS / INSTRUMENTAL Y HERRAJE REQUERIDOS

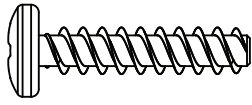

ADV (x6)

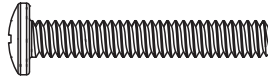

EYR (x2)

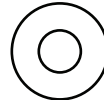

AEE (x2)



ADK (x2)

3.12

- Align the holes in the header with those in the gable.
- Aligner les trous dans le linteau avec ceux dans le pignon.
- Alinear los agujeros en el dintel con los de la fachada.



*Note: The flat holes face away from the gable.
Remarque : Les trous plats font face de l'autre côté du pignon.
Nota: Los agujeros lisos miran en contra de la fachada.*

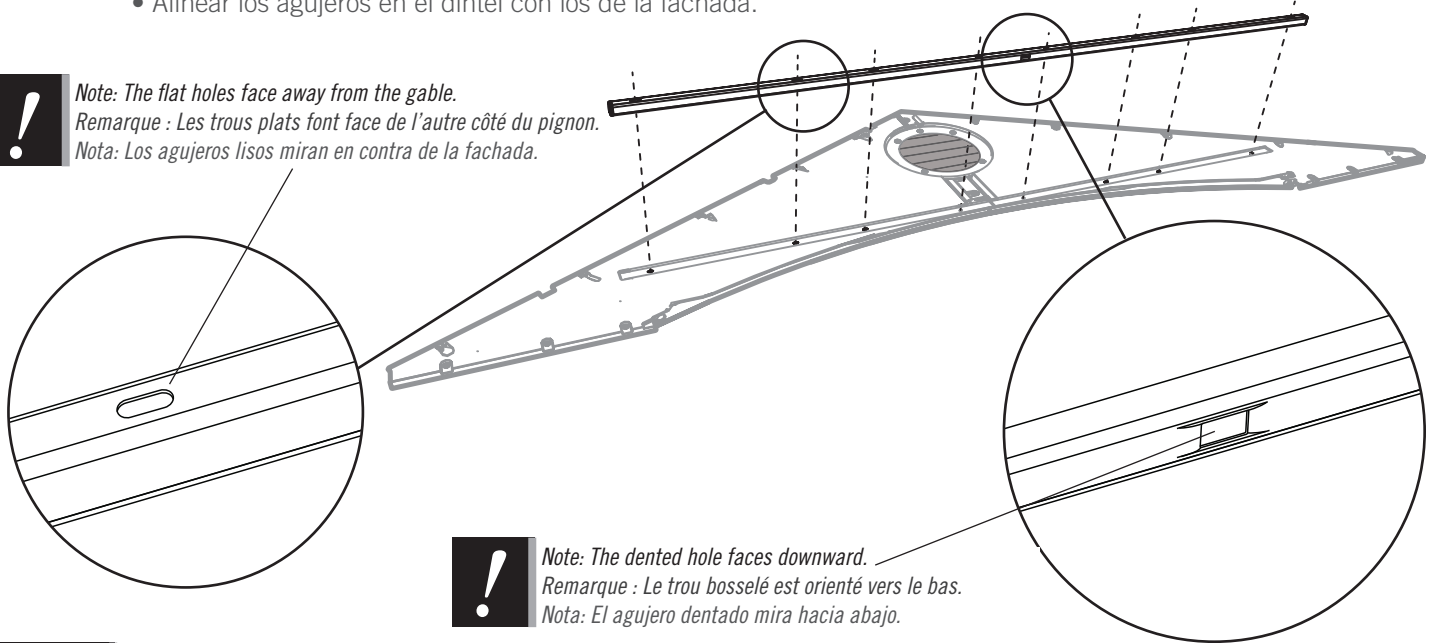

*Note: The dented hole faces downward.
Remarque : Le trou bosselé est orienté vers le bas.
Nota: El agujero dentado mira hacia abajo.*

3.13

- Secure with two (2) screws (EYR), two (2) washers (AEE), and two (2) nuts (ADK) ...
- Fixer le linteau à l'aide de deux (2) vis (EYR), deux (2) rondelles (AEE), et deux écrous (ADK) ...
- Sujetar el dintel con dos (2) tornillos (EYR), dos (2) rondanas (AEE), y dos tuercas (ADK) ...

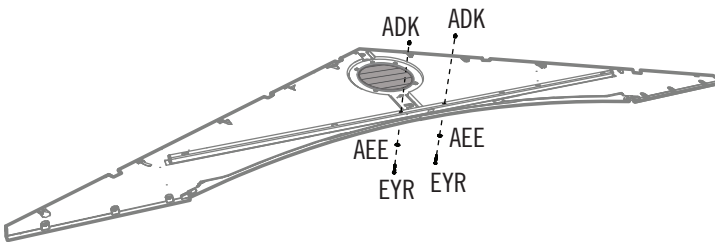

3.14

- ... and six (6) more screws (ADV).
- ... et six (6) vis (ADV) de plus.
- ... y seis (6) tornillos (ADV) más.

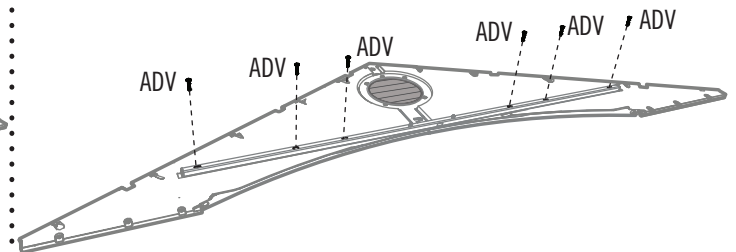

4

LEFT DOOR ASSEMBLY / ASSEMBLAGE DE LA PORTE GAUCHE / ENSAMBLAJE DE LA PUERTA IZQUIERDA



HARDWARE REQUIRED / QUINCAILLERIE REQUISE / HERRAJE REQUERIDO

Hardware Bags / Sacs de quincaillerie / Bolsas de herraje



ADW (x3)

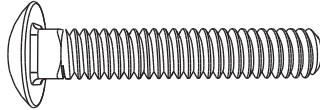

ABU (x2)



ADJ (x2)

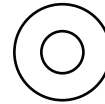

AEE (x3)

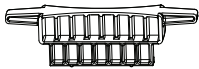

AHM (x2)



FUH (x1)

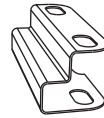

AIB (x1)

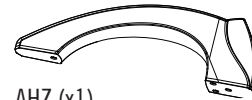

AHZ (x1)



PARTS REQUIRED / PIÈCES REQUISES / PIEZAS REQUERIDAS

Metal Parts / Pièces en métal / Piezas de metal



AFC (x1)

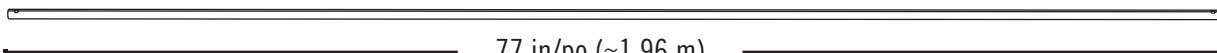

CRD (x1)

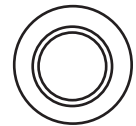

Plastic Parts / Pièces en plastique / Piezas de plástico

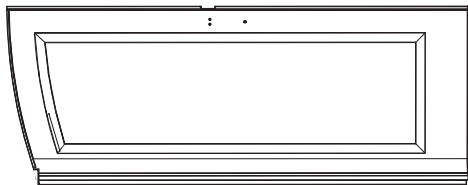

BDJ (x1)



TOOLS REQUIRED / OUTILS REQUIS / INSTRUMENTAL REQUERIDO

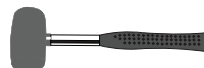

7/16 in/po (≈11 mm)

► SECTION 4 (CONTINUED) / SECTION 4 (SUITE) / SECCIÓN 4 (CONTINUACIÓN)

TOOLS AND HARDWARE REQUIRED / OUTILS ET QUINCAILLERIE REQUIS / INSTRUMENTAL Y HERRAJE REQUERIDOS



- If you have trouble with this section, follow the code below to view a video on the assembly in this section.
- En cas de problèmes avec cette section, suivre le code en bas pour voir un vidéo sur l'assemblage à cette section.
- En caso de problemas con esta sección, seguir el código debajo para ver un video sobre el ensamblaje en esta sección.

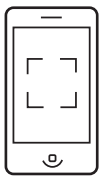

<http://go.lifetime.com/leftdoor8foot>

4.1

- Slide a **hinge tube (CRD)** down into the hole at the top of the **left door (BDJ)**.
- Faire glisser le **tube d'articulation (CRD)** dans le trou au bord supérieur de la **porte gauche (BDJ)**.
- Deslizar el **tubo de articulación (CRD)** en el agujero a la parte superior de la **puerta izquierda (BDJ)**.

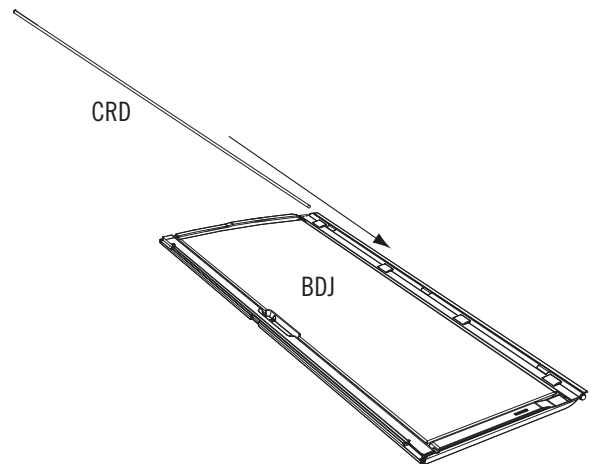

- Door channels (AFC) are bowed by design, ensuring a tight fit when they are closed and latched, making your shed more secure. These channels are formed with a slight bend to the adjoining door edge—like parentheses facing each other: (). When the door handle is gently closed and latched, there should be a slight pressure sealing the doors and eliminating any gaps. Be sure to read the step-by-step instructions carefully to successfully install the door channels.
- Les canaux pour le bord des portes (AFC) sont courbés par dessein, en s'assurant un ajustage lorsque les portes se ferment, en faisant votre abri plus sûr. Ces canaux sont fabriqués avec une légère courbe au bord de la porte adjacent — comme les parenthèses qui font face l'une l'autre : (). Lorsque la poignée se ferme, il devrait un légère pression en rebouchant les portes et en éliminant des ouvertures. Veiller à lire avec soin les instructions étape par étape pour pouvoir installer avec succès les canaux pour le bord des portes.
- Los canales para el borde de las puertas (AFC) son curvados por diseño, asegurando un ajuste fijo cuando las puertas estén cerrados con pestillo, haciendo su caseta más segura. Estos canales están formados con una curva ligera al borde de la puerta adyacente, como los paréntesis uno enfrente al otro: (). Cuando el picaporte esté ligeramente cerrado con pestillo, debería tener una presión ligera sellando las puertas y eliminando los espacios. Asegúrese de leer detenidamente las instrucciones paso a paso para poder instalar exitosamente los canales para el borde de las puertas.



AFC

► SECTION 4 (CONTINUED) / SECTION 4 (SUITE) / SECCIÓN 4 (CONTINUACIÓN)

TOOLS AND HARDWARE REQUIRED / OUTILS ET QUINCAILLERIE REQUIS / INSTRUMENTAL Y HERRAJE REQUERIDOS

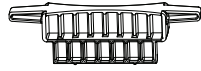

AHM (x2)

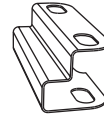

AIB (x1)

4.2

- Set the **deadbolts (AHM)** down into the recesses at the top and bottom of the door. Then, slide the **door channel (AFC)** over the edge of the door and the bottom of the deadbolts as shown.
- Mettre les **loquets à pêne dormant (AHM)** dans les espaces vides aux parties supérieure et inférieure de la porte. Ensuite, faire glisser le **canal de la porte (AFC)** sur le bord de la porte et les parties inférieures des loquets à pêne dormant comme illustré.
- Poner los **cerrojos (AHM)** en los huecos a las partes superior e inferior de la puerta. Entonces, deslizar el **canal para el borde de la puerta (AFC)** sobre el borde de la puerta y las partes inferiores de los cerrojos como se muestra.

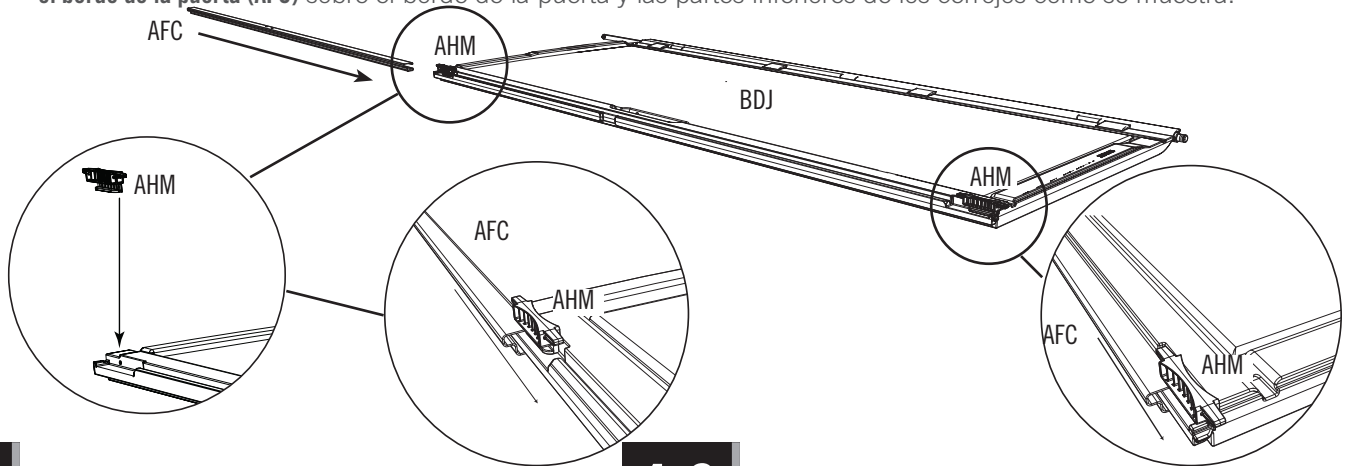

4.3

- *Note: The Deadbolts are used for locking the door. They may not move freely at first. You may need to tap them up and down a few times with a rubber mallet to work them in.*
- *Remarque : Les loquets s'utilisent pour fermer la porte. Au début, il se peut que les loquets ne se déplaceraient librement. Il faut peut-être les taper légèrement à l'aide d'un maillet en caoutchouc pour les desserrer.*
- *Nota: Se usan los cerrojos para cerrar la puerta. Al principio, pueden que no se desplacen libremente. Si es necesario, darlos unos golpecitos con un mazo de goma para aflojarlos.*

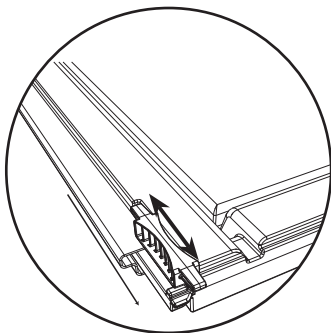

- Slide the **strike plate (AIB)** over the door channel, and align the holes.
- Faire glisser la **poignée (AIB)** sur le canal de la porte, et aligner les trous.
- Deslizar la **placa de impacto (AIB)** sobre el canal de la puerta, y alinear los agujeros.

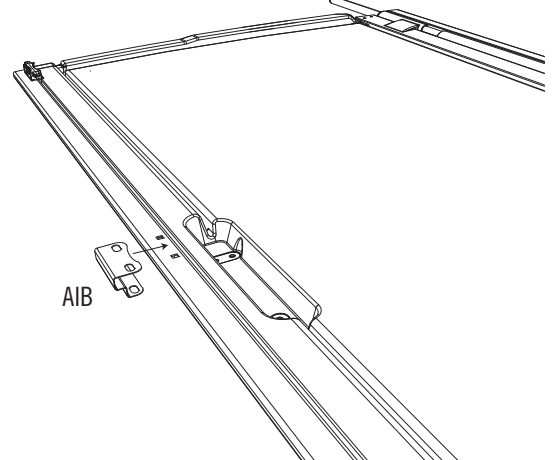

► SECTION 4 (CONTINUED) / SECTION 4 (SUITE) / SECCIÓN 4 (CONTINUACIÓN)

TOOLS AND HARDWARE REQUIRED / OUTILS ET QUINCAILLERIE REQUIS / INSTRUMENTAL Y HERRAJE REQUERIDOS



7/16 in/po
(≈11 mm)

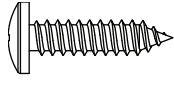

ADW (x3)

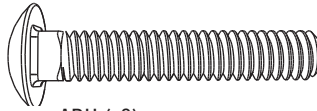

ABU (x2)



ADJ (x2)



AHZ (x1)



FUH (x1)

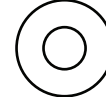

AEE (x3)

4.4

- Attach the **door latch (FUH)** to the door using the hardware included. **Do not overtighten.**
- Attacher le **loquet (FUH)** à la porte à l'aide de la quincaillerie incluse. **Ne pas trop serrer.**
- Sujetar la **placa de cierre (FUH)** a la puerta usando el herraje incluido. **No apretar demasiado.**

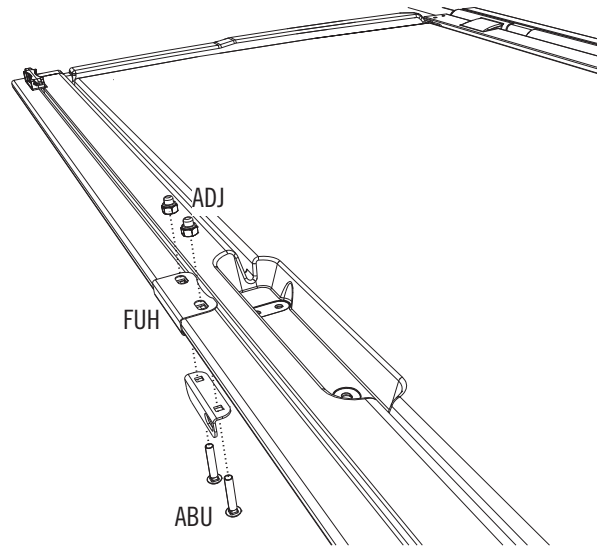

4.5

- Attach the **handle (AHZ)** using the hardware included.
- Attacher la **poignée (AHZ)** à l'aide de la quincaillerie incluse.
- Sujetar el **picaporte (AHZ)** usando el herraje incluido.

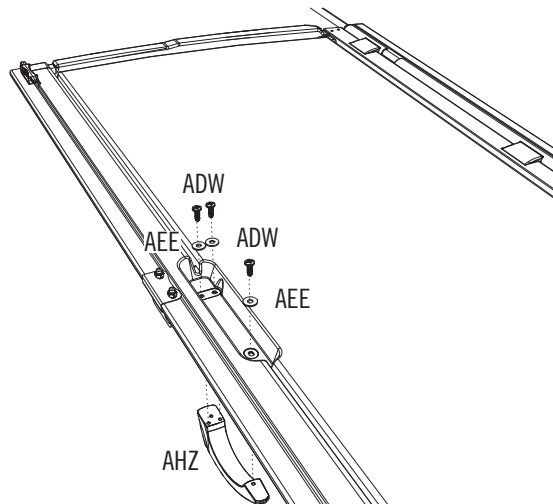

5

RIGHT DOOR ASSEMBLY / ASSEMBLAGE DE LA PORTE DROITE / ENSAMBLAJE DE LA PUERTA DERECHA



HARDWARE REQUIRED / QUINCAILLERIE REQUISE / HERRAJE REQUERIDO

Hardware Bag / Sac de quincaillerie / Bolsa de herraje

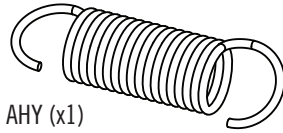

AHY (x1)

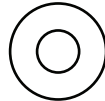

AEE (x5)

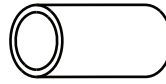

ADB (x2)

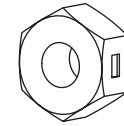

AAB (x2)



AEB (x2)

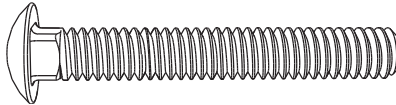

ABV (x2)

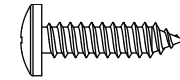

ADW (x4)

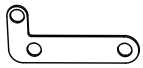

FUM (x1)

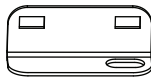

FUL (x1)

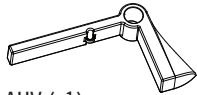

AHV (x1)

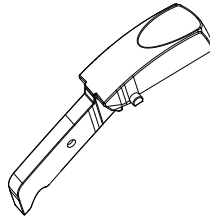

AIO (x1)

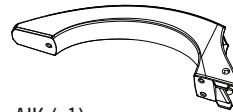

AIK (x1)

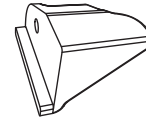

AHW (x1)



PARTS REQUIRED / PIÈCES REQUISES / PIEZAS REQUERIDAS

Metal Parts / Pièces en métal / Piezas de metal



AFC (x1)



CRD (x1)



Plastic Parts / Pièces en plastique / Piezas de plástico

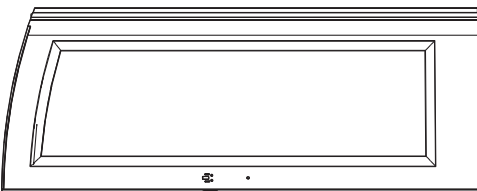

BDK (x1)



TOOLS REQUIRED / OUTILS REQUIS / INSTRUMENTAL REQUERIDO

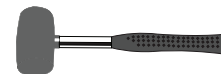
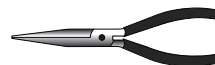

7/16" (≈11 mm)

► SECTION 5 (CONTINUED) / SECTION 5 (SUITE) / SECCIÓN 5 (CONTINUACIÓN)

TOOLS AND HARDWARE REQUIRED / OUTILS ET QUINCAILLERIE REQUIS / INSTRUMENTAL Y HERRAJE REQUERIDOS



- If you have trouble with this section, follow the code below to view a video on the assembly in this section.
- En cas de problèmes avec cette section, suivre le code en bas pour voir un vidéo sur l'assemblage de cette section.
- En caso de problemas con esta sección, seguir el código debajo para ver un video sobre el ensamblaje de esta sección.

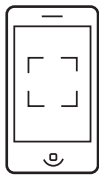

<http://go.lifetime.com/rightdoor8ft>

5.1

- Slide a **hinge tube (CRD)** down into the hole at the top of the **right door (BDK)**.
- Faire glisser le **tube d'articulation (CRD)** dans le trou au bord supérieur de la **porte droite (BDK)**.
- Deslizar el **tubo de articulación (CRD)** en el agujero a la parte superior de la **puerta derecha (BDK)**.

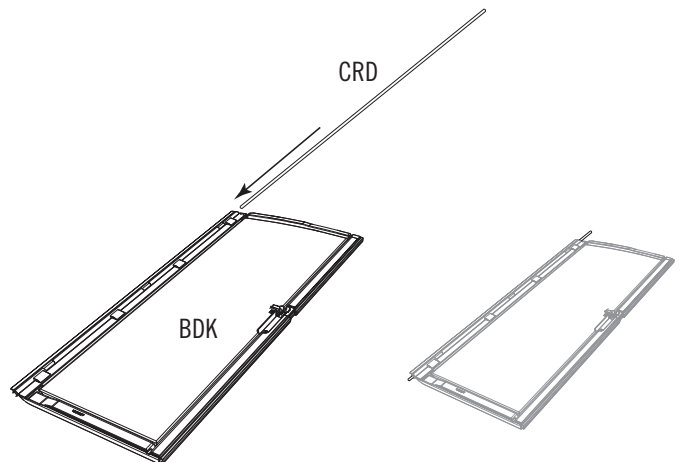

- Door channels (AFC) are bowed by design, ensuring a tight fit when they are closed and latched, making your shed more secure. These channels are formed with a slight bend to the adjoining door edge—like parentheses facing each other: (). When the door handle is gently closed and latched, there should be a slight pressure sealing the doors and eliminating any gaps. Be sure to read the step-by-step instructions carefully to successfully install the door channels.
- Les canaux pour le bord des portes (AFC) sont courbés par dessein, en s'assurant un ajustage lorsque les portes se ferment, en faisant votre abri plus sûr. Ces canaux sont fabriqués avec une légère courbe au bord de la porte adjacent — comme les parenthèses qui font face l'une l'autre : (). Lorsque la poignée se ferme, il devrait un légère pression en rebouchant les portes et en éliminant des ouvertures. Veiller à lire avec soin les instructions étape par étape pour pouvoir installer avec succès les canaux pour le bord des portes.
- Los canales para el borde de las puertas (AFC) son curvados por diseño, asegurando un ajuste fijo cuando las puertas estén cerrados con pestillo, haciendo su caseta más segura. Estos canales están formados con una curva ligera al borde de la puerta adyacente, como los paréntesis uno enfrente al otro: (). Cuando el picaporte esté ligeramente cerrado con pestillo, debería tener una presión ligera sellando las puertas y eliminando los espacios. Asegúrese de leer detenidamente las instrucciones paso a paso para poder instalar exitosamente los canales para el borde de las puertas.



AFC

► SECTION 5 (CONTINUED) / SECTION 5 (SUITE) / SECCIÓN 5 (CONTINUACIÓN)

TOOLS AND HARDWARE REQUIRED / OUTILS ET QUINCAILLERIE REQUIS / INSTRUMENTAL Y HERRAJE REQUERIDOS

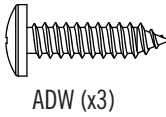
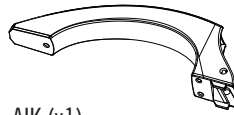
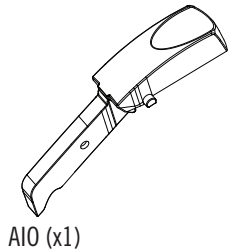
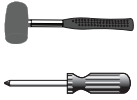

5.2

- Slide the **door channel (AFC)** over the edge of the door as shown.
- Faire glisser le **canal de la porte (AFC)** sur le bord de la porte comme illustré.
- Deslizar el **canal para el borde de la puerta (AFC)** sobre el borde de la puerta como se muestra.

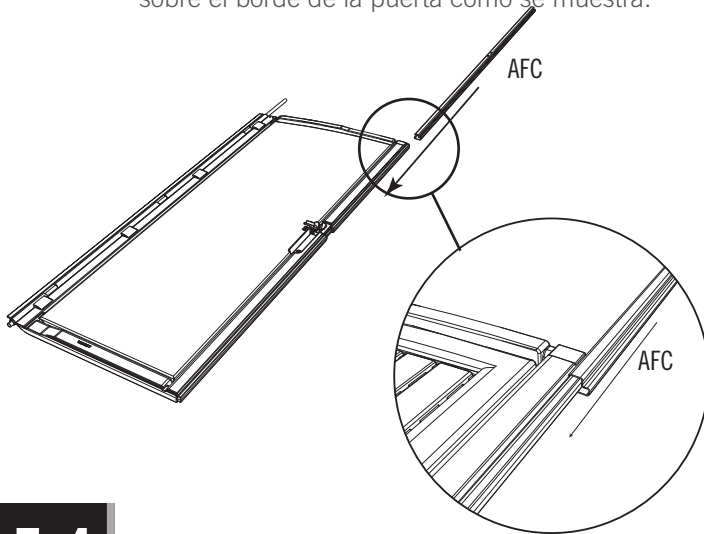

5.3

- Slide the **thumb lever (AIO)** down into the grooves in the **door handle (AIK)** until the nubs fit into the holes.
- Faire glisser le **levier poussoir (AIO)** dans les rainures de la **poignée (AIK)** jusqu'à ce que les petites bosses se fixent dans les trous.
- Deslizar la **palanca de pulgar (AIO)** en las ranuras del **picaporte (AIK)** hasta que los nudos se encajen en los agujeros.

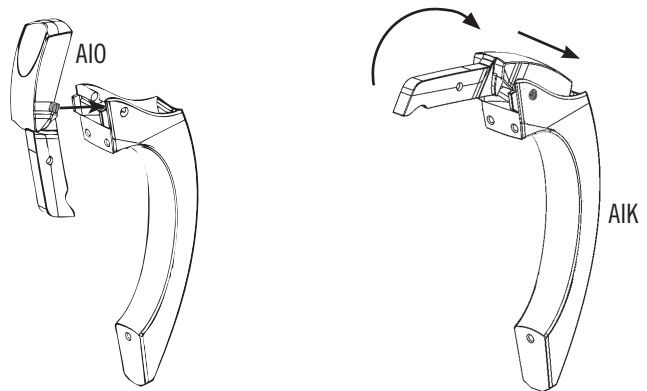

5.4

- Attach the handle using the hardware included.
- Attacher la poignée à l'aide de la quincaillerie incluse.
- Sujetar el picaporte usando el herraje incluido.

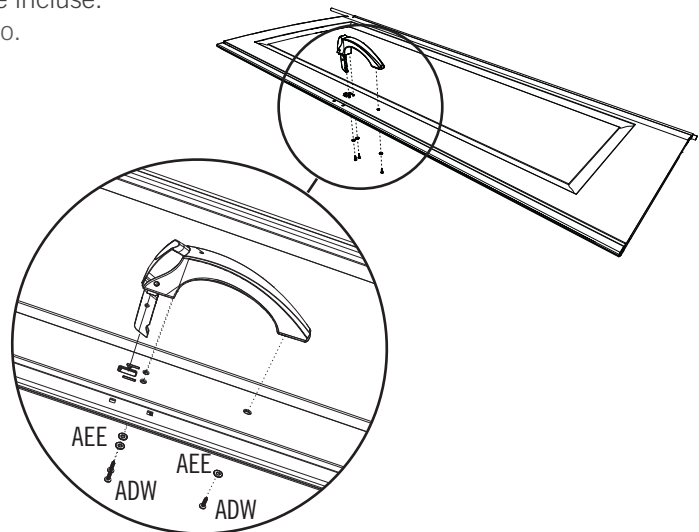

SECTION 5 (CONTINUED) / SECTION 5 (SUITE) / SECCIÓN 5 (CONTINUACIÓN)

TOOLS AND HARDWARE REQUIRED / OUTILS ET QUINCAILLERIE REQUIS / INSTRUMENTAL Y HERRAJE REQUERIDOS



7/16"
(≈11 mm)

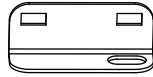

FUL (x1)

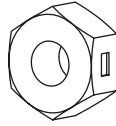

AAB (x2)

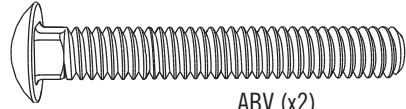

ABV (x2)

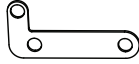

FUM (x1)

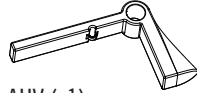

AHV (x1)



ADB (x2)

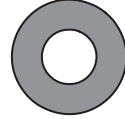

AEB (x2)

5.5

- Attach the locking hardware using the hardware included. **The arm of the latch rests on top of the thumb lever.**
- Attacher les accessoires de verrouillage à l'aide de la quincaillerie incluse. **Le bras du loquet doit rester sur le levier poussoir.**
- Sujetar los accesorios de cierre usando el herraje incluido. **El brazo del pestillo se queda sobre la palanca de pulgar.**

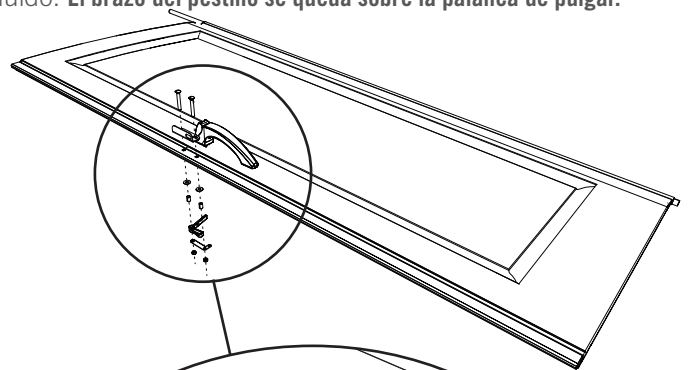

Thumb lever
Levier poussoir
Palanca de pulgar

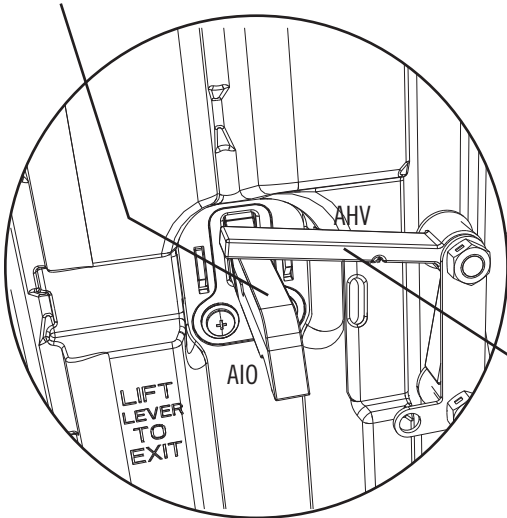

Arm of latch
Bras du loquet
Brazo del pestillo

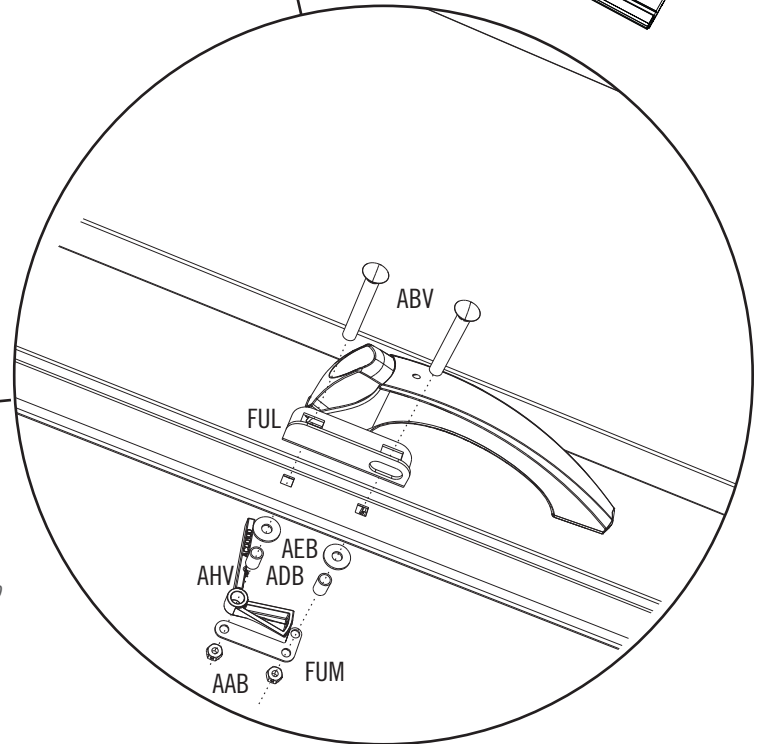

Rear of door / Arrière de la porte / Trasero de la puerta

► SECTION 5 (CONTINUED) / SECTION 5 (SUITE) / SECCIÓN 5 (CONTINUACIÓN)

TOOLS AND HARDWARE REQUIRED / OUTILS ET QUINCAILLERIE REQUIS / INSTRUMENTAL Y HERRAJE REQUERIDOS

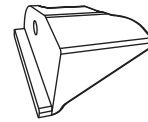
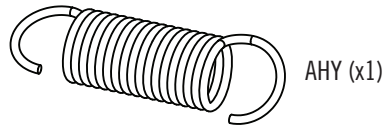
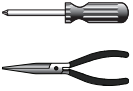

AHW (x1)

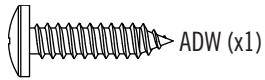

5.6

- Attach the **bracket (AHW)** using a **screw (ADW)**, and attach the **spring (AHY)**.
- Attacher le **support (AHW)** à l'aide d'une **vis (ADW)**, et attacher le **ressort (AHY)**.
- Sujetar el **soporte (AHW)** usando un **tornillo (ADW)**, y sujetar el **resorte (AHY)**.

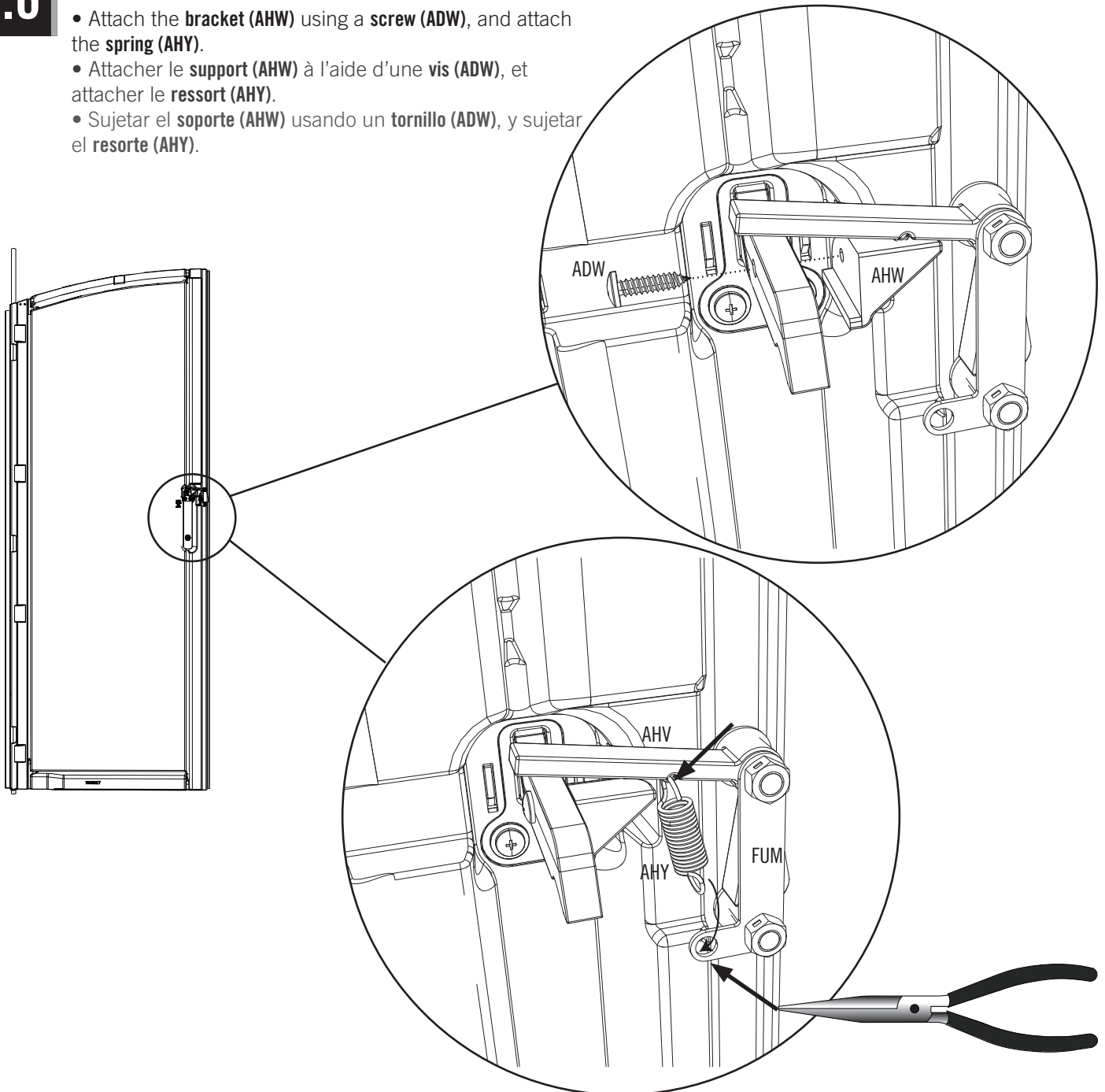

6

FLOOR ASSEMBLY / ASSEMBLAGE DU PLANCHER / ENSAMBLE DEL PISO



HARDWARE REQUIRED / QUINCAILLERIE REQUISE / HERRAJE REQUERIDO

Hardware Bag / Sac de quincaillerie / Bolsa de herraje

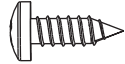

BQC (x20)



ADC (x1)

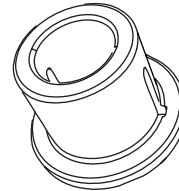

AHO (x2)



Note: These Screws do not anchor the Floor; they only hold the Panels together.

Remarque : Ces vis n'ancrent pas le plancher ; ils ne servent que pour attacher les panneaux les uns aux autres.

Nota: Estos tornillos no anclan el piso; sirven sólo para sujetar los paneles los unos a los otros.



PARTS REQUIRED / PIÈCES REQUISES / PIEZAS REQUERIDAS

Plastic Parts / Pièces en plastique / Piezas de plástico

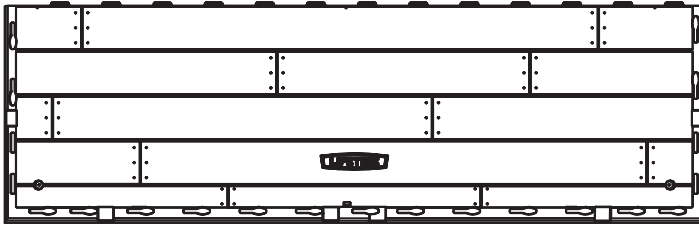

CUW (x2)

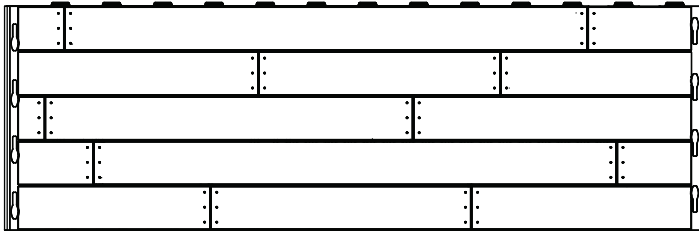

CUD (x2)



TOOLS REQUIRED / OUTILS REQUIS / INSTRUMENTAL REQUERIDO



► SECTION 6 (CONTINUED) / SECTION 6 (SUITE) / SECCIÓN 6 (CONTINUACIÓN)

TOOLS AND HARDWARE REQUIRED / OUTILS ET QUINCAILLERIE REQUIS / INSTRUMENTAL Y HERRAJE REQUERIDOS



AHO (x2)

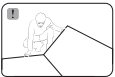

- If you have trouble with this section, follow the code below to view a video on the assembly in this section.
- En cas d'avoir des problèmes avec cette section, suivre le code en bas pour voir un vidéo sur l'assemblage dans cette section.
- En caso de tener problemas con esta sección, seguir el código debajo para ver un video sobre el ensamblaje en esta sección.

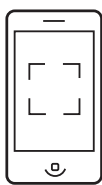

<http://go.lifetime.com/8x10fwfloor>

6.2

- Attach the second **inner floor panel (CUD)** to the first inner floor panel.
- Attacher le deuxième **panneau de plancher intérieur (CUD)** au premier panneau de plancher intérieur.
- Fijar el segundo **panel de piso interior (CUD)** al primer panel de piso interior.

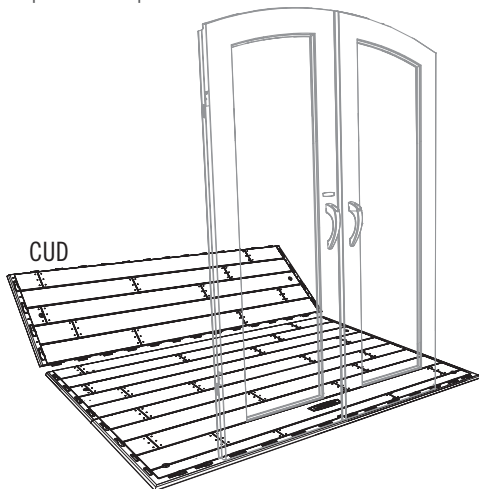

6.1

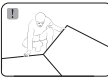

- Hold an **inner floor panel (CUD)** at a 45° angle and slide the tabs along the edge underneath an **outer floor panel (CUW)**. The tabs interlock. Lay Panel flat.
- Poser un **panneau de plancher intérieur (CUD)** à un angle de 45° et faire glisser les languettes le long du bord au-dessus du **panneau de plancher extérieur (CUW)**. Les languettes s'enclenchent les uns les autres. L'étendre par terre.
- Colocar un **panel de piso interior (CUD)** a un ángulo de 45° y deslizar las lengüetas a lo largo del borde debajo el **panel de piso exterior (CUW)**. Las lengüetas se entrelazan las unas con las otras. Aplanar el panel.

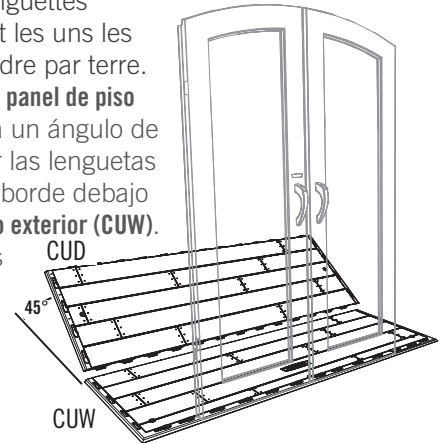

6.3

- Then, attach an **outer floor panel (CUW)** to the inner floor panel. Insert the **bushings (AHO)**.
- Ensuite, attacher un autre **panneau de plancher intérieur (CUW)** au panneau de plancher intérieur. Insérer les **bagues (AHO)**.
- Entonces, fijar otro **panel de piso exterior (CUW)** al panel de piso interior. Insertar los **casquillos (AHO)**.

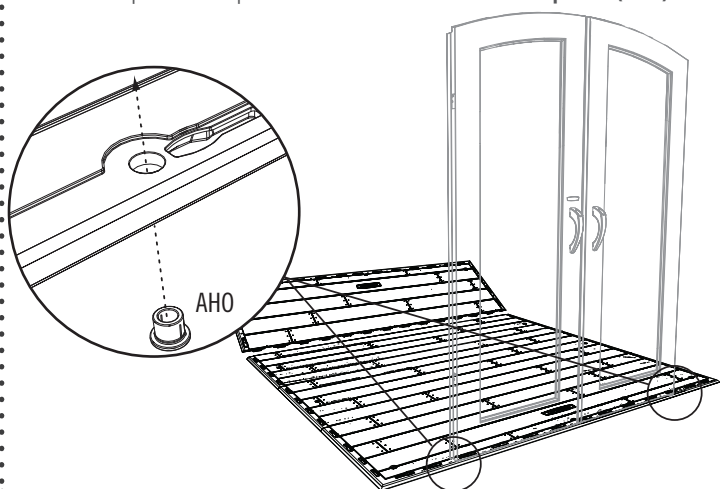

► SECTION 6 (CONTINUED) / SECTION 6 (SUITE) / SECCIÓN 6 (CONTINUACIÓN)

TOOLS AND HARDWARE REQUIRED / OUTILS ET QUINCAILLERIE REQUIS / INSTRUMENTAL Y HERRAJE REQUERIDOS

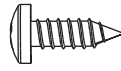

BQC (x18)

6.4

- Finally, insert the **screws (BQC)** through the divots in the floor panels and into the tabs of the adjacent floor panels. (The divots are near the seams of the floor panels.)
- Enfin, insérer les **vis (BQC)** à travers les marques dans les panneaux de plancher et dans les languettes du panneaux de plancher contigu. (Les marques se trouvent près des jonctions des panneaux de plancher.)
- Por último, insertar los **tornillos (BQC)** a través de las marcas en los paneles de piso y dentro de las lengüetas de los paneles de piso adyacentes. (Se encuentran las marcas cerca de las juntas de los paneles de piso.)



Note: These screws do not anchor the floor; they only hold the panels together.

Remarque : Ces vis n'ancrent pas le plancher ; ils ne servent que pour attacher les panneaux les uns aux autres.

Nota: Estos tornillos no anclan el piso; sirven sólo para sujetar los paneles los unos a los otros.

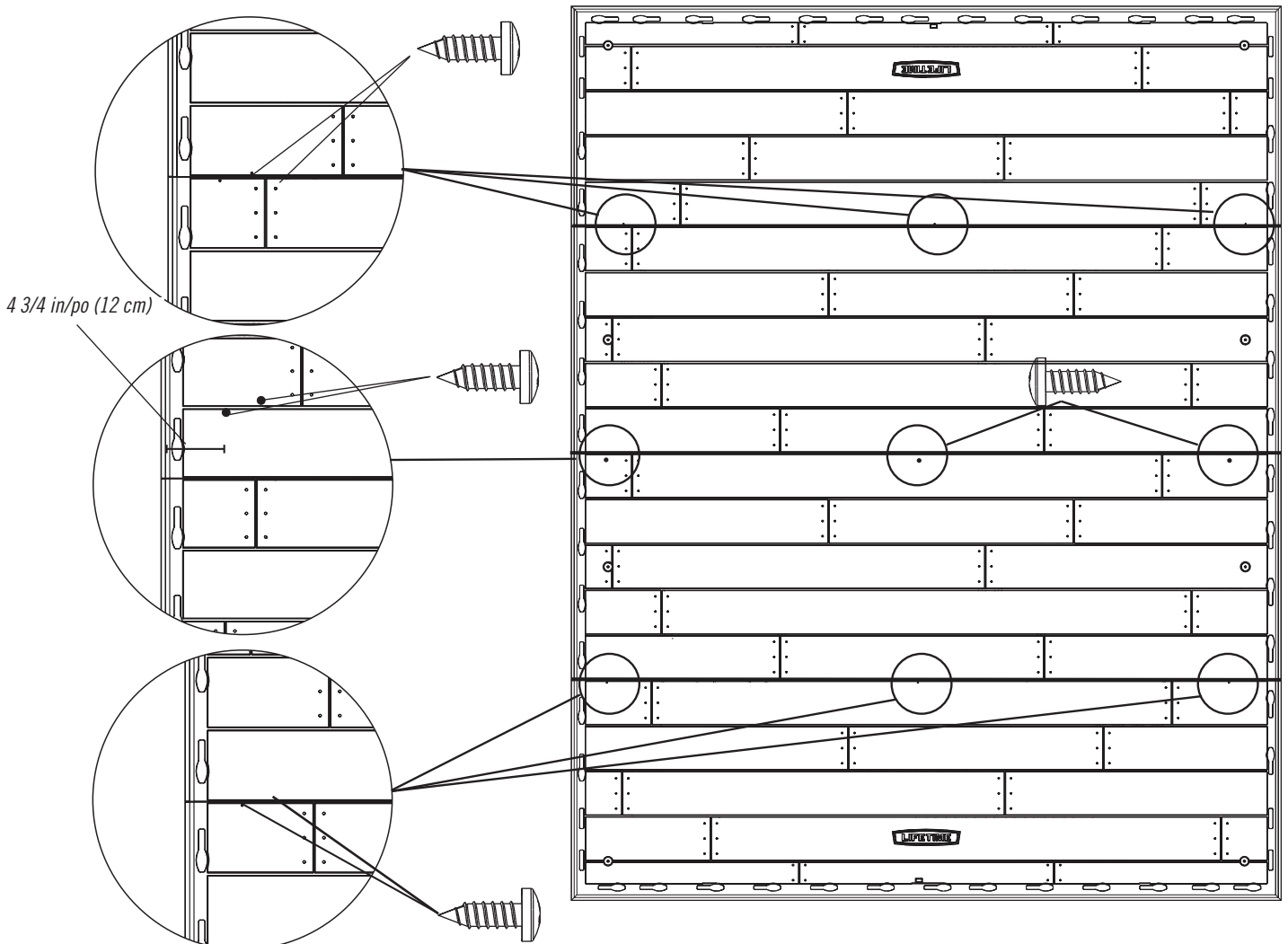

7

WALL ASSEMBLY / ASSEMBLAGE DES MURS / ENSAMBLAJE DE LOS MUROS



HARDWARE REQUIRED / QUINCAILLERIE REQUISE / HERRAJE REQUERIDO

Hardware Bag / Sac de quincaillerie / Bolsa de herraje

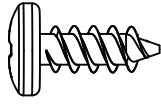

ADZ (x91)

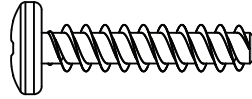

ADV (x4)



PARTS REQUIRED / PIÈCES REQUISES / PIEZAS REQUERIDAS

Metal Parts / Pièces en métal / Piezas de metal



FLB (x1)

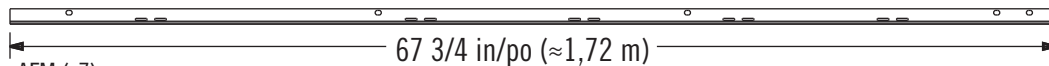

AFM (x7)

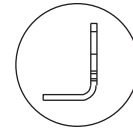
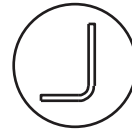

Plastic Parts / Pièces en plastique / Piezas de plástico

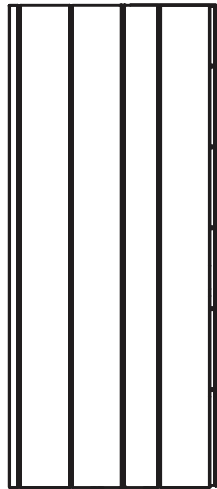

AGY (x1)

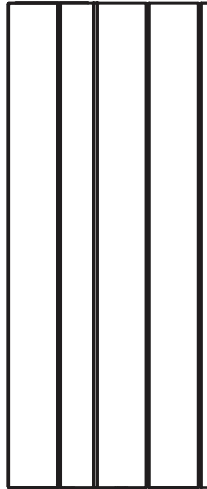

AGN (x1)



AGW (x1)

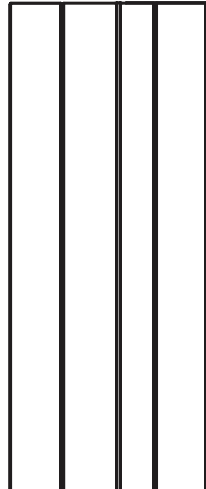

AGL (x1)

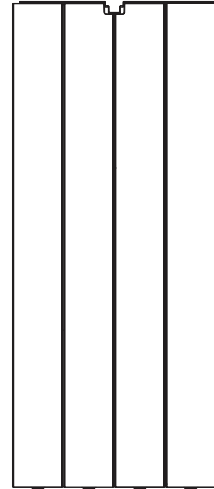

AHD (x7)

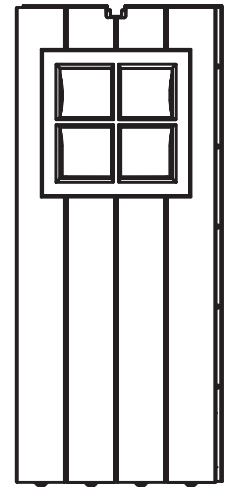

AHH (x1)



TOOLS REQUIRED / OUTILS REQUIS / INSTRUMENTAL REQUERIDO



AIW (x1)

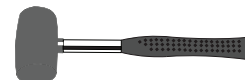

► SECTION 7 (CONTINUED) / SECTION 7 (SUITE) / SECCIÓN 7 (CONTINUACIÓN)

TOOLS AND HARDWARE REQUIRED / OUTILS ET QUINCAILLERIE REQUIS / INSTRUMENTAL Y HERRAJE REQUERIDOS

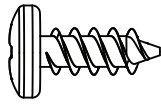

ADZ (x28)

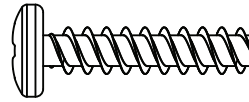

ADV (x4)

7.1

- Top end
- Dessus
- Extremo superior



- No screw in top hole.
- Aucune vis sur le trou de dessus.
- Sin tornillo en el agujero superior.

- Secure a **wall support channel (AFM)** just to the left of the notch on the seven (7) **wall panels (AHD)** using four (4) **screws (ADZ)** for each.
- Fixer un **canal de support mural (AFM)** juste à gauche de l'encoche sur les sept (7) **panneaux muraux (AHD)** en utilisant quatre (4) **vis (ADZ)** pour chacun.
- Sujetar un **canal de soporte mural (AFM)** justo a la izquierda de la muesca en los siete (7) **paneles murales (AHD)** usando cuatro (4) **tornillos (ADZ)** para cada uno.

- Notch
- Encoche
- Muesca

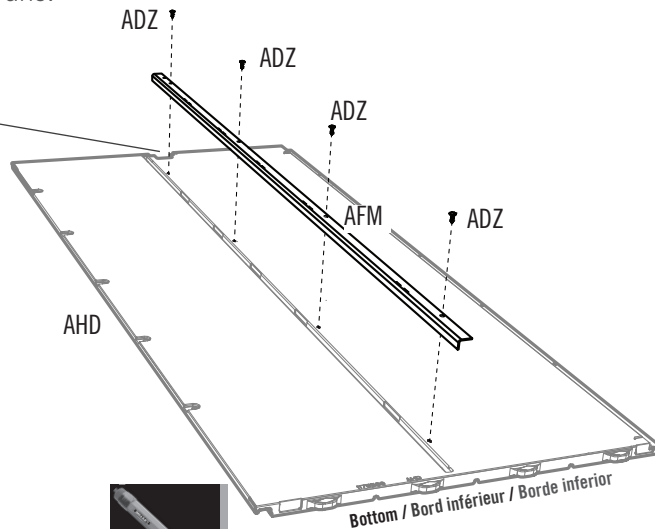

7.2

- Secure a **wall support channel (FLB)** just to the left of the notch on the **window wall panel (AHH)** using four (4) **screws (ADV)** for each.
- Fixer un **canal de support mural (FLB)** juste à gauche de l'encoche sur **panneau murau à fenêtre (AHH)** en utilisant quatre (4) **vis (ADV)** pour chacun.
- Sujetar un **canal de soporte mural (FLB)** justo a la izquierda de la muesca en el **panel mural para ventana (AHH)** usando cuatro (4) **tornillos (ADV)** para cada uno.

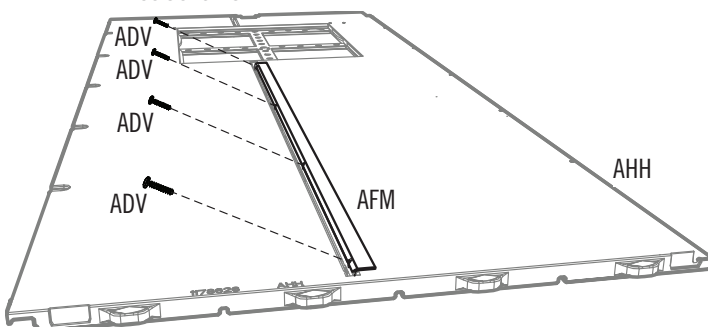

- The two front corner wall panels have a three-letter ID, **AGY** and **AGN**, located near the top or bottom edge of each Panel.
- Les deux panneaux muraux en coin avant possèdent un identifiant à trois lettres, **AGY** et **AGN**, placé près du bord supérieur ou inférieur du panneau.
- Los dos paneles murales de esquina delanteros tienen una identificación de tres letras, **AGY** y **AGN**, localizadas en el borde superior o inferior del panel.

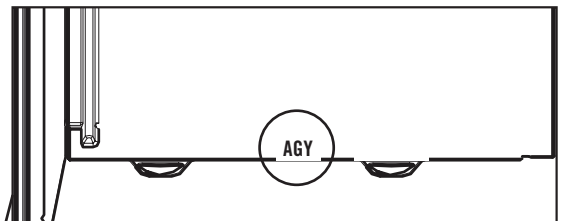

► SECTION 7 (CONTINUED) / SECTION 7 (SUITE) / SECCIÓN 7 (CONTINUACIÓN)

TOOLS AND HARDWARE REQUIRED / OUTILS ET QUINCAILLERIE REQUIS / INSTRUMENTAL Y HERRAJE REQUERIDOS

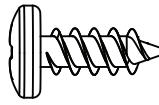

ADZ (x8)

7.3

- Secure a **wall support channel (AFM)** to the **corner wall panel (AGY)** using four (4) **screws (ADZ)**. The end with two holes goes at the top.
- Fixer un **canal de soporte mural (AFM)** au **panneau mural en coin (AGY)** en utilisant quatre (4) **vis (ADZ)**. L'extrémité avec deux trous va sur le dessus.
- Sujetar un **canal de soporte mural (AFM)** al **panel mural de esquina (AGY)** usando cuatro (4) **tornillos (ADZ)**. El extremo con dos agujeros va a la parte superior.

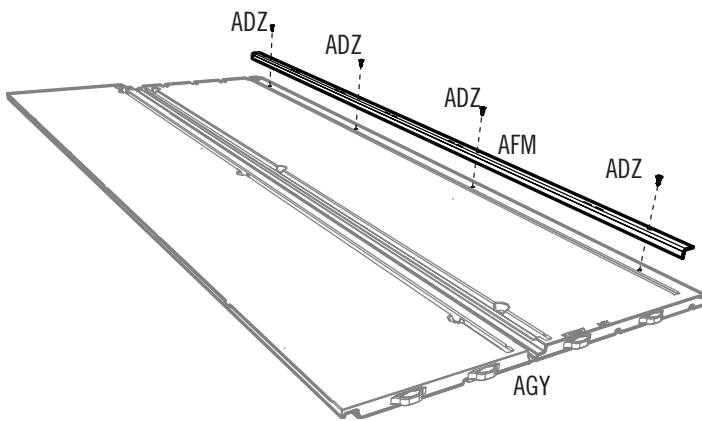

7.4

- Secure a **wall support channel (AFM)** to the **corner wall panel (AGN)** using four (4) **screws (ADZ)**. The end with two holes goes at the bottom.
- Fixer le **canal de soporte mural (AFM)** au **panneau mural en coin (AGN)** en utilisant quatre (4) **vis (ADZ)**. L'extrémité avec deux trous va sur le dessous.
- Sujetar un **canal de soporte mural (AFM)** al **panel mural de esquina (AGN)** usando cuatro (4) **tornillos (ADZ)**. El extremo con dos agujeros va en la parte inferior.

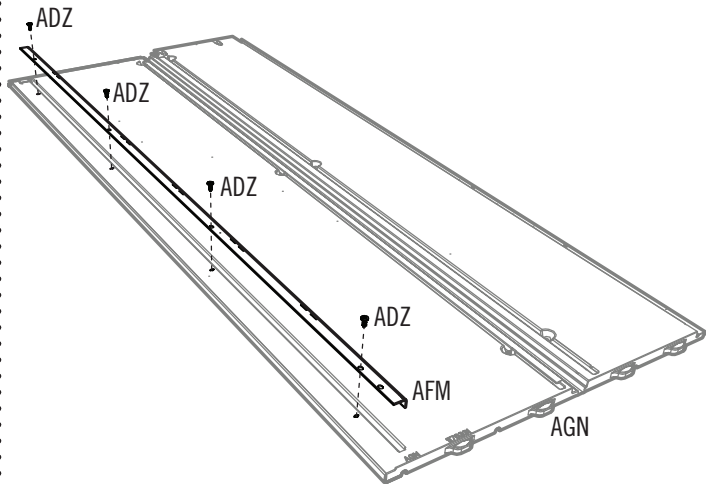

7.5

- Insert the two left-most tabs at the bottom of the **corner panel (AGY)** into the two right-most slots along the edge of the floor.
- Insérer les deux languettes gauches au bord inférieur du **panneau angulaire (AGY)** dans les deux rainures droites le long du bord du plancher.
- Intsertar las lengüetas al borde inferior del **panel angular (AGY)** en las ranuras a lo largo del borde del piso.

- Wall support channel (AFM)
- Canal de soporte mural (AFM)
- Canal de soporte mural (AFM)

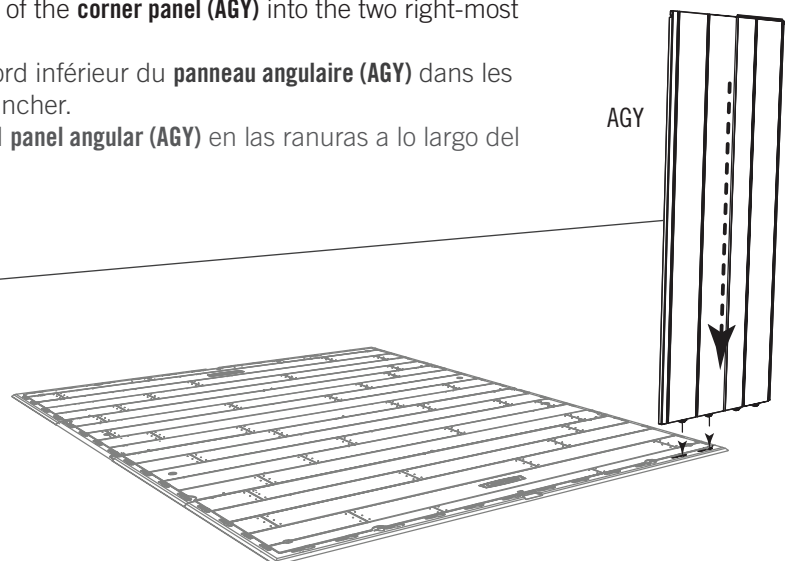

► SECTION 7 (CONTINUED) / SECTION 7 (SUITE) / SECCIÓN 7 (CONTINUACIÓN)

TOOLS AND HARDWARE REQUIRED / OUTILS ET QUINCAILLERIE REQUIS / INSTRUMENTAL Y HERRAJE REQUERIDOS



AIW (x1)



7.6

- Slide the panel to the left.
- Faire glisser le panneau à gauche.
- Deslizar el panel a la izquierda.

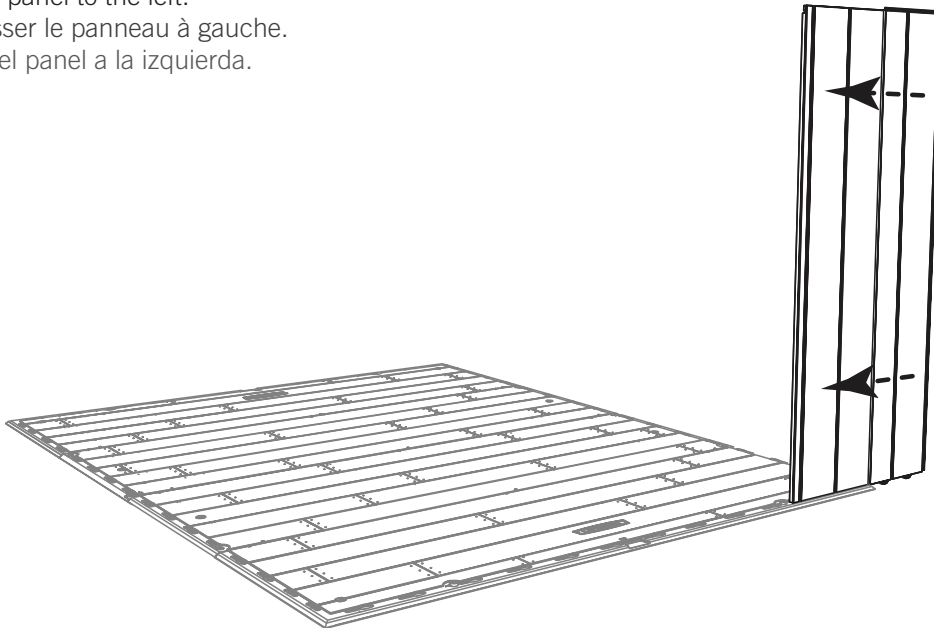

7.7

- Bend corner panel, and pull down on panel to insert the two remaining tabs. To help with insertion, place the **wood block (AIW)** under the floor panel directly under the tab being inserted. You should hear a “click” when the tab pops into place. **Repeat this step for the second tab.**
- Plier le panneau angulaire, et tirer pour insérer les deux languettes restantes. Pour aider avec le montage, mettre le **bloque en bois (AIW)** sous le panneau de plancher directement sous la languette à insérer. **Répéter ce processus pour la deuxième languette.**
- Doblar el panel angular, y tirar para abajo para introducir las dos lengüetas restantes. Para ayudar con el armado, deslizar el **bloque de madera (AIW)** debajo el panel de piso directamente debajo la lengüeta a insertar. Se escucha un «clic» cuando la lengüeta se sienta en su lugar. **Repetir este proceso para la segunda lengüeta.**

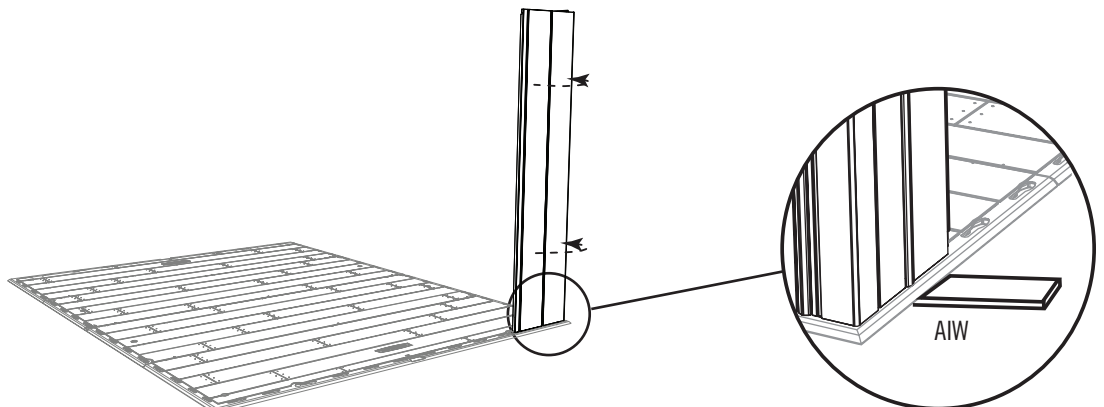



PARTS IDENTIFIER / IDENTIFICATEUR DE PIÈCES / IDENTIFICADOR DE PIEZAS

CONTENTS OF BOX 1 / CONTENU DE LA BOÎTE 1 / CONTENIDO DE LA CAJA 1

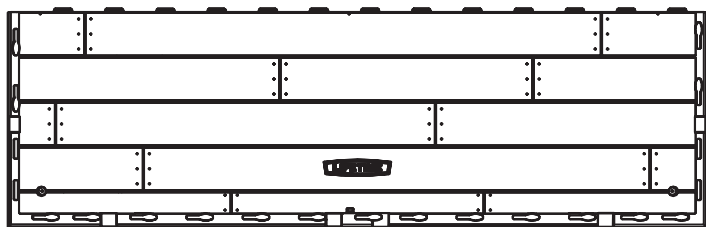

CUW (x2)

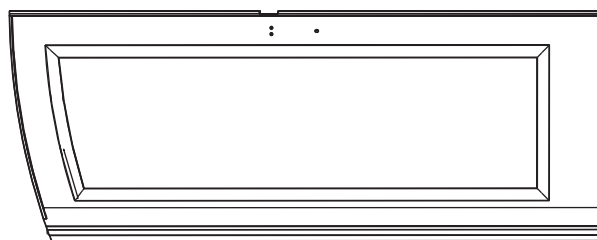

BDJ (x1)

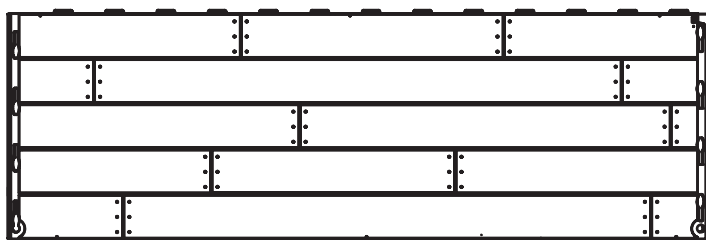

CUD (x2)

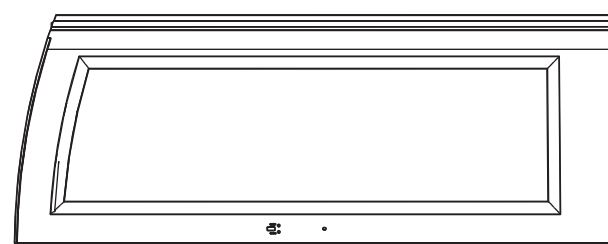

BDK (x1)

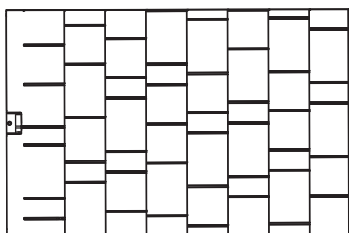

AGQ (x8)



AFV (x1)

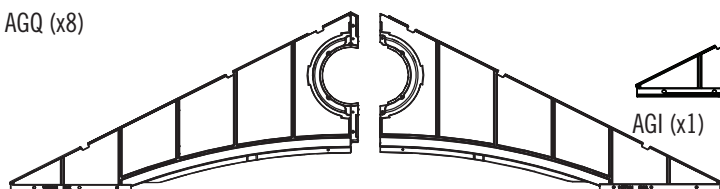

EVZ (x1)



EWA (x1)

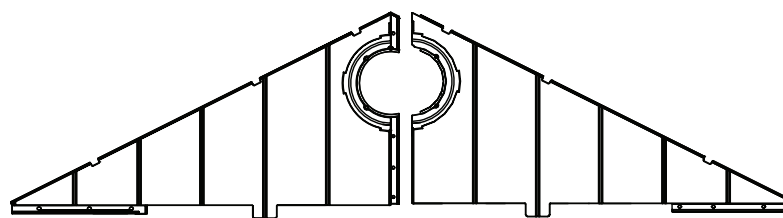

AGI (x1)

AGH (x1)

CONTENTS METAL KIT 1 / CONTENU DU KIT DE PIÈCES EN MÉTAL 1 / CONTENIDO DEL KIT DE PIEZAS DE METAL 1



50 9/16 in/po (≈1,28 m)

DSR (x6)

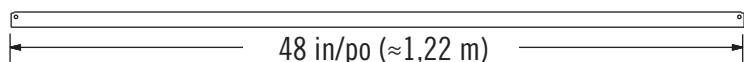

AFG (x3)



AFE (x1)

59 1/2 in/po (≈1,51 m)

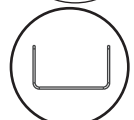

Remove this section for quick reference / Enlever cette section pour référence rapide / Retirar esta sección para referencia rápida



PARTS IDENTIFIER / IDENTIFICATEUR DE PIÈCES / IDENTIFICADOR DE PIEZAS

Remove this section for quick reference / Enlever cette section pour référence rapide / Retirar esta sección para referencia rápida

CONTENTS METAL KIT 2 / CONTENU DU KIT DE PIÈCES EN MÉTAL 2 / CONTENIDO DEL KIT DE PIEZAS DE METAL 2



AFC (x2)



EYS (x1)

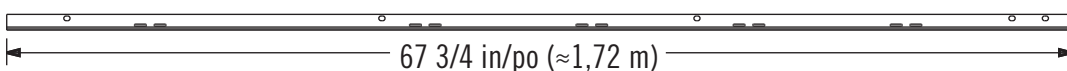
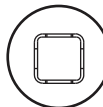

AFM (x9)

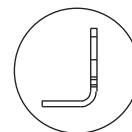

CRD (x2)

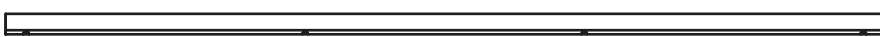

FLB (x1)

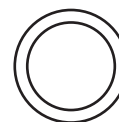

CONTENTS OF BOX 2 / CONTENIDO DE LA CAJA 2 / CONTENU DE LA BOÎTE 2

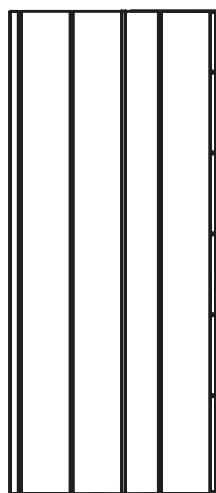

AGY (x1)

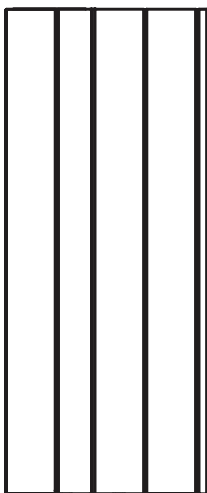

AGN (x1)



AGW (x1)

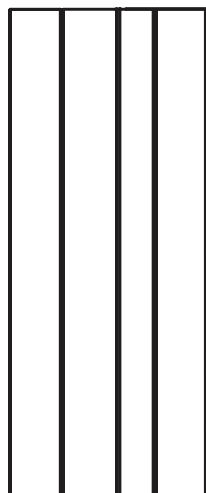

AGL (x1)

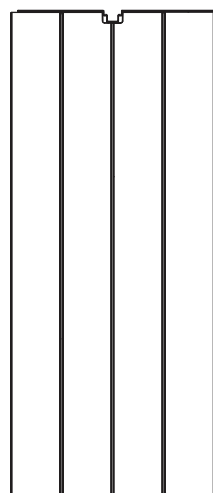

AHD (x7)

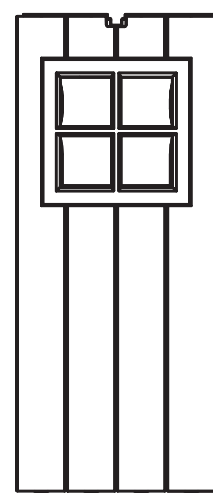

AHH (x1)

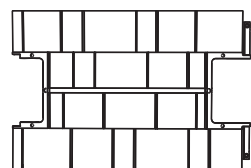

AFY (117) (x3)



PARTS IDENTIFIER / IDENTIFICATEUR DE PIÈCES / IDENTIFICADOR DE PIEZAS

CONTENTS OF BOX 2 / CONTENIDO DE LA CAJA 2 / CONTENU DE LA BÔTE 2



CONTENTS OF SMALL PARTS BOX / CONTENIDO DE LA CAJA DE PIEZAS PEQUEÑAS / CONTENU DE LA BÔTE DE PETITES PIÈCES



AIW (x1)

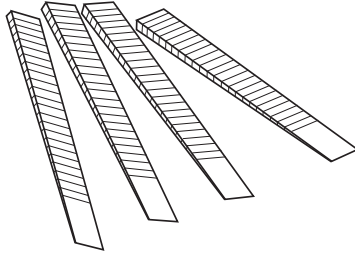

AIX (x4)

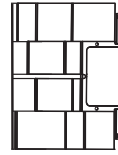

AGG (115) (x1)

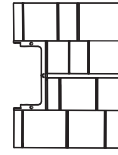

AFW (116) (x1)

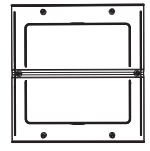

AHC (x4)

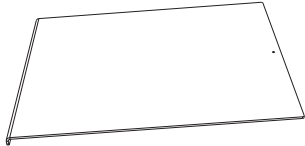

AHE (x1)

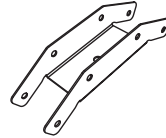

AIP (x3)



AFL (x8)

HARDWARE BAGS / SACS DE QUINCAILLERIE / BOLSAS DE HERRAJE



Remove this section for quick reference / Enlever cette section pour référence rapide / Retirar esta sección para referencia rápida



Remove this section for quick reference / Enlever cette section pour référence rapide / Retirar esta sección para referencia rápida

*THIS PAGE INTENTIONALLY LEFT BLANK
CETTE PAGE A ÉTÉ LAISSÉE BLANCHE INTENTIONNELLEMENT
ESTA PÁGINA SE HA DEJADO EN BLANCO DELIBERADAMENTE*

► SECTION 7 (CONTINUED) / SECTION 7 (SUITE) / SECCIÓN 7 (CONTINUACIÓN)

TOOLS AND HARDWARE REQUIRED / OUTILS ET QUINCAILLERIE REQUIS / INSTRUMENTAL Y HERRAJE REQUERIDOS



AIW (x1)

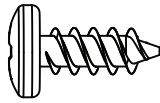

ADZ (x30)

7.8

- One at a time, insert the four tabs at the bottom of a **wall panel (AHD)** or **window wall panel (AHH)** into the next four slots along the edge of the floor. **The window wall panel may be inserted on either side of the shed.**
- Un par un, insérer les quatre languettes au bord inférieur du **panneau mural (AHD)** ou **panneau mural pour la fenêtre (AHH)** dans les quatre rainures suivantes le long du bord du plancher. **Le panneau mural pour la fenêtre s'insère soit le côté droit soit le côté gauche.**
- Uno por uno, insertar las cuatro lengüetas al borde inferior del **panel mural (AHD)** o **panel mural para la ventana (AHH)** en las cuatro ranuras siguientes a lo largo del borde del piso. **Se pueden insertar el panel mural para la ventana en cualquiera de los dos lados.**

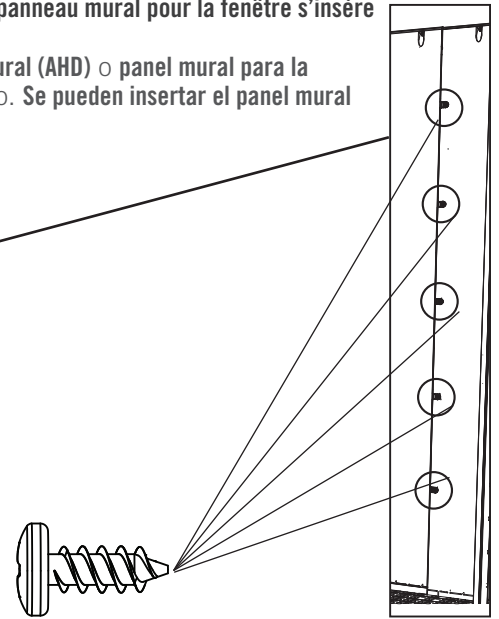
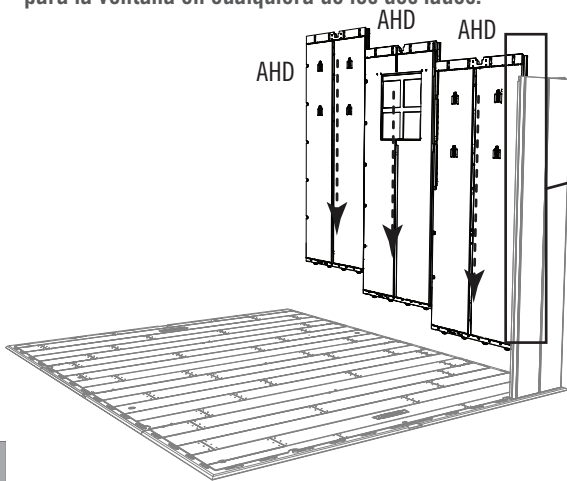

7.9

- Insert this **corner wall panel (AGW)** in the same way as the previous one.
- Insérer le **panneau angulaire (AGW)** de la même manière que le panneau angulaire précédent.
- Insertar este **panel angular (AGW)** de la misma manera que el panel angular anterior.

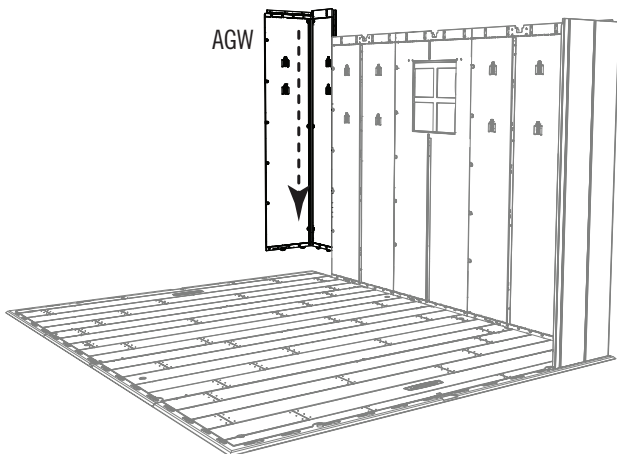

7.10

- Insert these **wall panels (AHD)** in the same way as the previous ones. **Do not attach window wall panels along the rear of the shed.**
- Insérer ces **panneaux muraux (AHD)** de la même manière que les panneaux précédents. **Ne pas insérer de panneaux muraux pour la fenêtre le long de bord arrière de l'abri.**
- Insertar estos **paneles murales (AHD)** de la misma manera que los paneles anteriores. **No insertar los paneles murales para la ventana a lo largo del borde trasero de la caseta.**

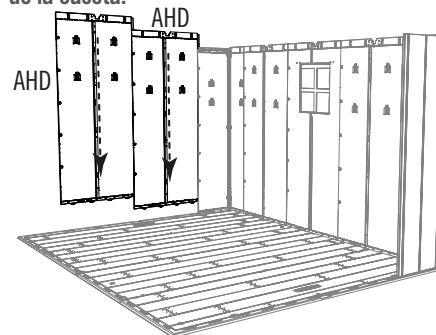

► SECTION 7 (CONTINUED) / SECTION 7 (SUITE) / SECCIÓN 7 (CONTINUACIÓN)

TOOLS AND HARDWARE REQUIRED / OUTILS ET QUINCAILLERIE REQUIS / INSTRUMENTAL Y HERRAJE REQUERIDOS



AIW (x1)

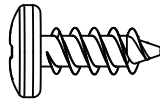

ADZ (x25)

7.11

- Insert this **corner wall panel (AGL)** in the same way as the previous one.
- Insérer le **panneau angulaire (AGL)** de la même manière que le panneau angulaire précédent.
- Insertar este **panel angular (AGL)** de la misma manera que el panel angular anterior.

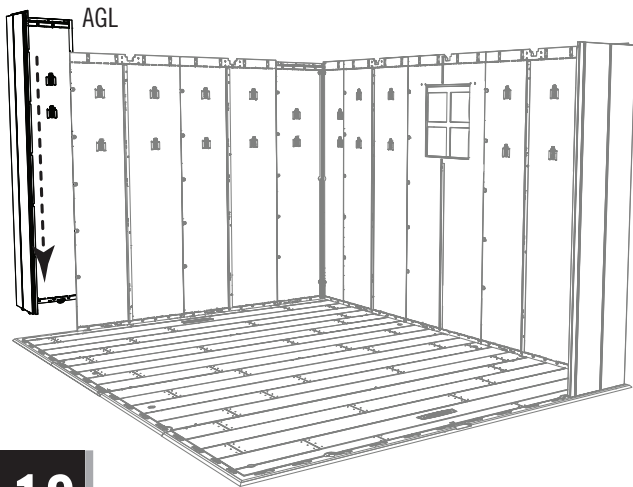

7.12

- Insert these wall panels in the same way as the previous ones.
- Insérer ces panneaux muraux dans la même manière que les panneaux précédents.
- Insertar estos paneles murales en la misma manera que los paneles anteriores.

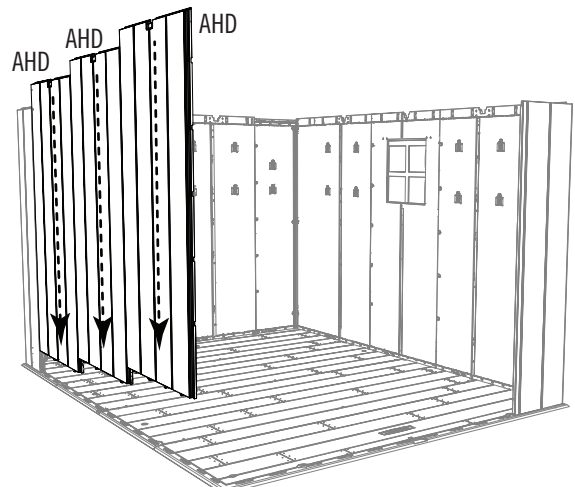

7.13

- Insert this **corner wall panel (AGN)** in the same way as the previous one.
- Insérer le **panneau angulaire (AGN)** de la même manière que le panneau angulaire précédent.
- Insertar este **panel angular (AGN)** de la misma manera que el panel angular anterior.

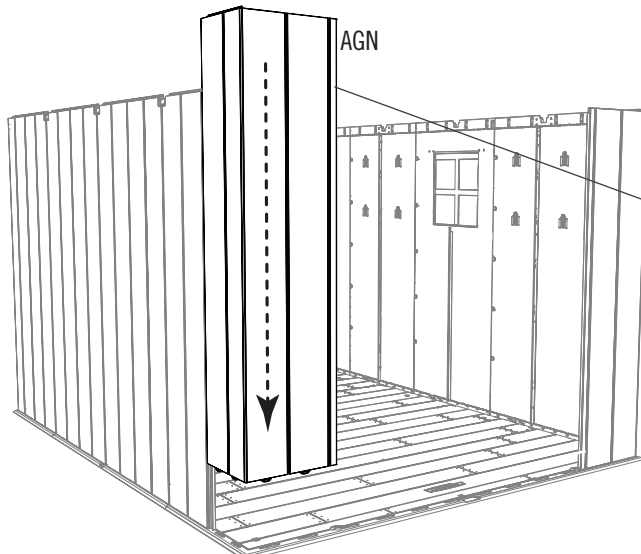

- Wall support channel (AFM)
- Canal de support mural (AFM)
- Canal de soporte mural (AFM)

8

SHELVING INSTALLATION / INSTALLATION DU RAYONNAGE / INSTALACIÓN DE LA ESTANTERÍA



HARDWARE REQUIRED / QUINCAILLERIE REQUISE / HERRAJE REQUERIDO

Hardware Bag / Sac de quincaillerie / Bolsa de herraje

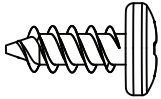

ADZ (x14)



AIY (x2)



PARTS REQUIRED / PIÈCES REQUISES / PIEZAS REQUERIDAS

Plastic Parts / Pièces en plastique / Piezas de plástico



AFV (x1)



TOOLS REQUIRED / OUTILS REQUIS / INSTRUMENTAL REQUERIDO



► SECTION 8 (CONTINUED) / SECTION 8 (SUITE) / SECCIÓN 8 (CONTINUACIÓN)

TOOLS AND HARDWARE REQUIRED / OUTILS ET QUINCAILLERIE REQUIS / INSTRUMENTAL Y HERRAJE REQUERIDOS



AIY (x2)

8.1

- Insert the **shelf brackets (AIY)** into the slots in the wall support channels. **The brackets must be at the same height and on the rear Wall.**
- Insérer les **supports d'étagère (AIY)** dans les fentes des canaux de support muraux. **Les supports d'étagère doivent être à la même hauteur et sur le mur arrière.**
- Insertar las **escuadras (AIY)** dentro de las ranuras en los canales de soporte murales. **Las escuadras deben estar a la misma altura y en el muro trasero.**

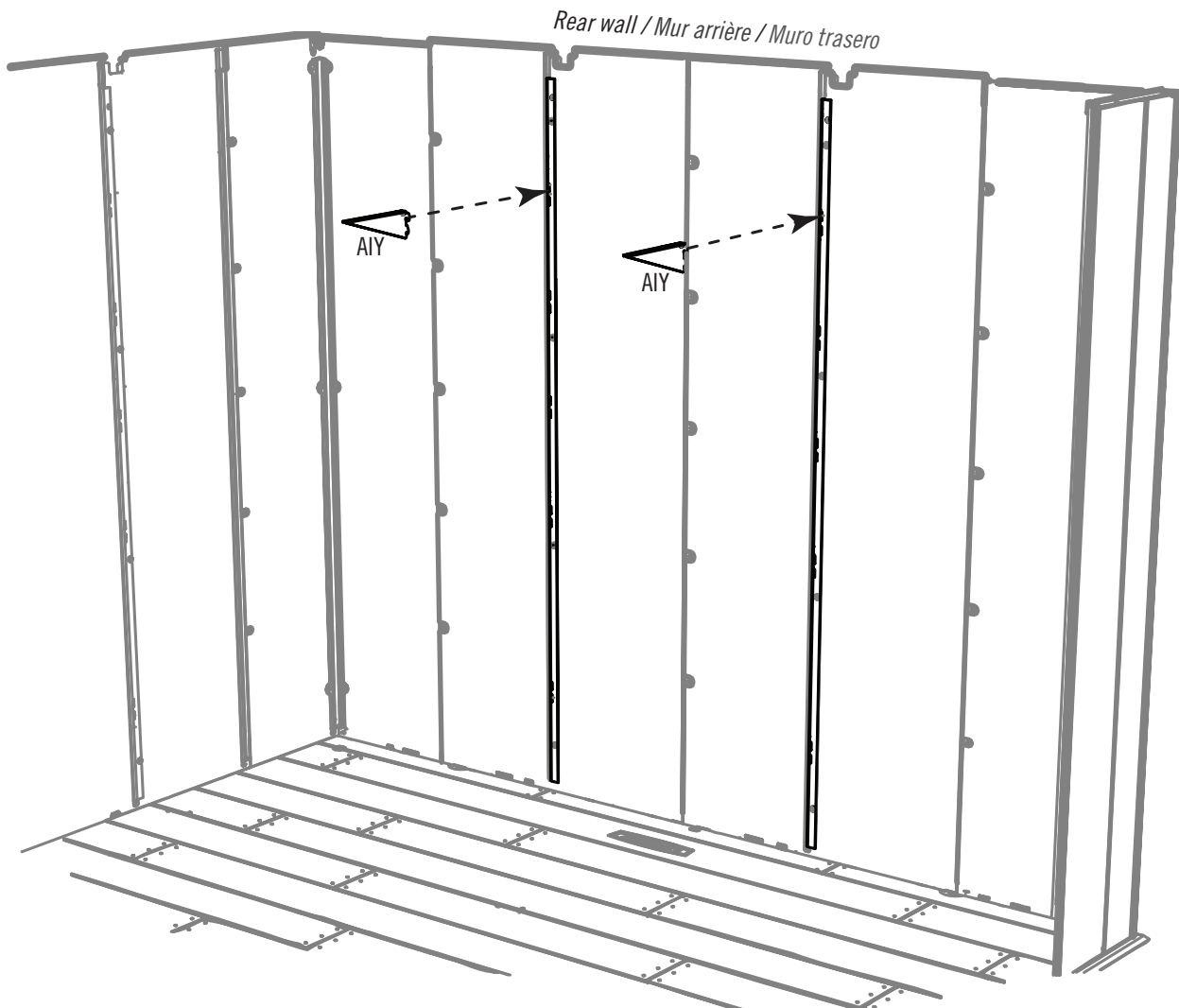

► SECTION 8 (CONTINUED) / SECTION 8 (SUITE) / SECCIÓN 8 (CONTINUACIÓN)

TOOLS AND HARDWARE REQUIRED / OUTILS ET QUINCAILLERIE REQUIS / INSTRUMENTAL Y HERRAJE REQUERIDOS

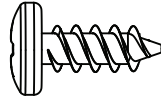

ADZ (x6)

8.2

- Fold the flaps on the ends of the **shelf (AFV)** up, and set the shelf onto the brackets. **The notches along the long edge should be against the rear wall.**
- Plier les volets sur les extrémités de l'**étagère (AFV)** vers le haut, et placer la tablette sur les supports. **Les fentes le long de la grande extrémité devraient être contre le mur arrière.**
- Doblar las aletas del **estante (AFV)** hacia arriba, y colocar el estante en las escuadras. **Las muescas a lo largo del borde largo debe quedarse contra el muro trasero.**

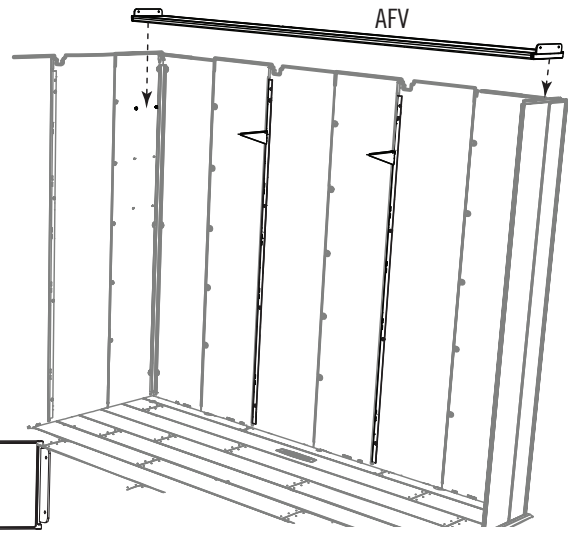
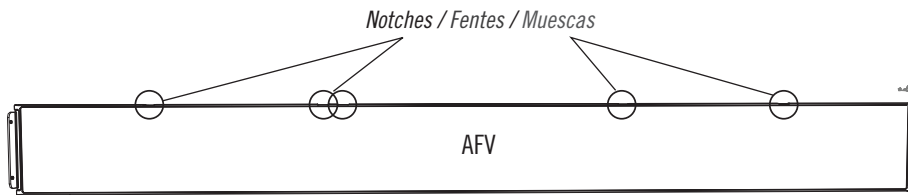

8.3

- Attach the **shelf (AFV)** to the corner wall panels and shelf brackets using six (6) **screws (ADZ)**.
- Attacher l'**étagère (AFV)** vers les panneaux muraux angulaires et les équerres en utilisant six (6) **vis (ADZ)**.
- Sujetar el **estante (AFV)** a los paneles murales de esquina y las escuadras usando seis (6) **tornillos (ADZ)**.

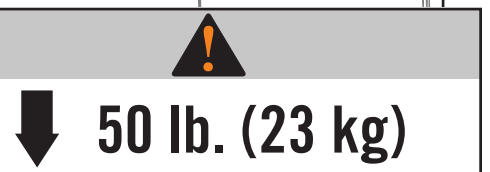
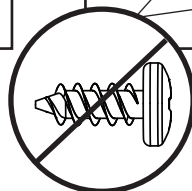
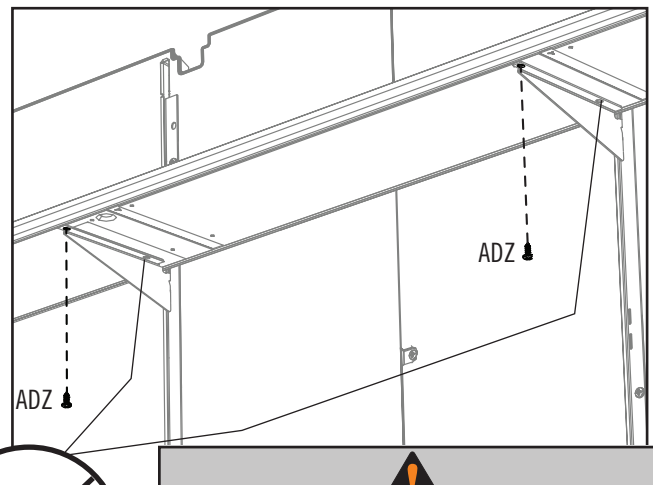
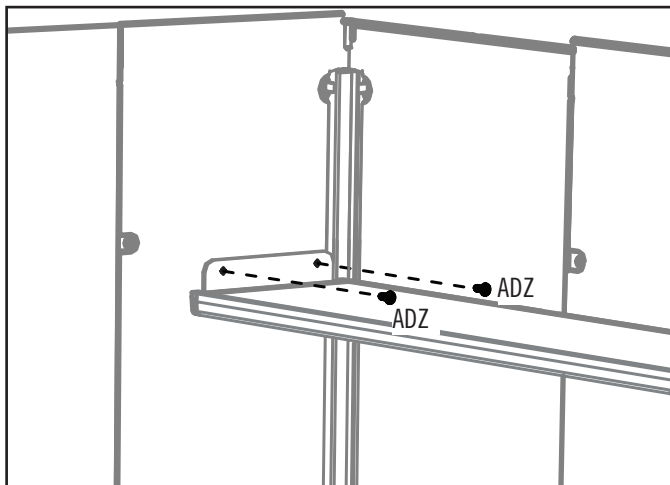

9

DOOR & ENTRY GABLE INSTALLATION / INSTALLATION DU TOIT À PIGNON ET DES PORTES / INSTALACIÓN DE LA FACHADA DE ENTRADA Y LAS PUERTAS



HARDWARE REQUIRED / QUINCAILLERIE REQUISE / HERRAJE REQUERIDO

Hardware Bag / Bolsa de herraje / Sac de quincaillerie

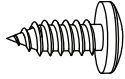

ADX (x4)



AHP (x2)

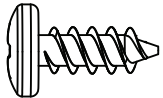

ADZ (x6)

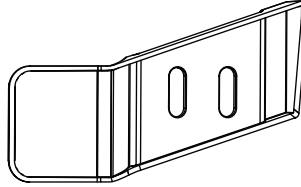

AIM (x1)

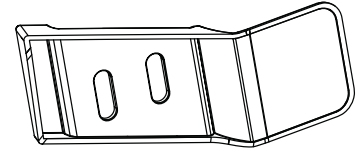

AIC (x1)



PARTS REQUIRED / PIÈCES REQUISES / PIEZAS REQUERIDAS

Plastic Parts / Piezas de plástico / Pièces en plastique

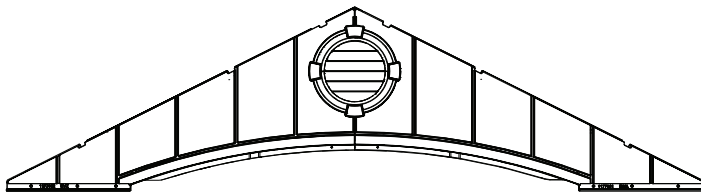

(x1)

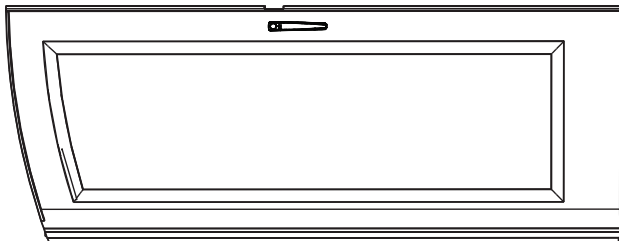

(x1)

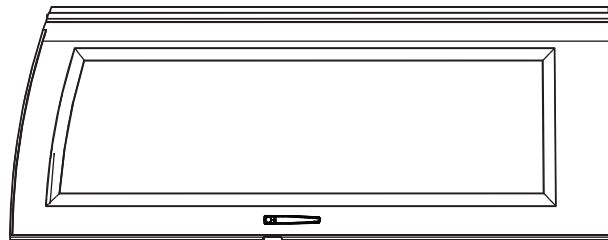

(x1)



TOOLS REQUIRED / OUTILS REQUIS / INSTRUMENTAL REQUERIDO

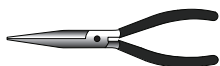

► SECTION 9 (CONTINUED) / SECTION 9 (SUITE) / SECCIÓN 9 (CONTINUACIÓN)

TOOLS AND HARDWARE REQUIRED / OUTILS ET QUINCAILLERIE REQUIS / INSTRUMENTAL Y HERRAJE REQUERIDOS



AHP (x2)

9.1



- Pull the Hinge Tube down out of the Door about six inches. Align the hole at the bottom of the Hinge Tube with the slit in the Bushing, and insert the Tube. Insert a **Cotter Pin (AHP)** and bend the ends.
- Tirer le tube d'articulation à peu près quinze centimètres du bord inférieur de la porte. Aligner le trou dans la partie inférieure du tube avec la fente dans la bague, et insérer le tube. Insérer une **clavette (AHP)**, et plier les extrémités.
- Extender el tubo de articulación unos quince centímetros del borde inferior de la puerta. Alinear el agujero en la parte inferior del tubo con la rendija en el casquillo, e insertar el tubo. Insertar una **Clavija (AHP)** y doble los extremos.

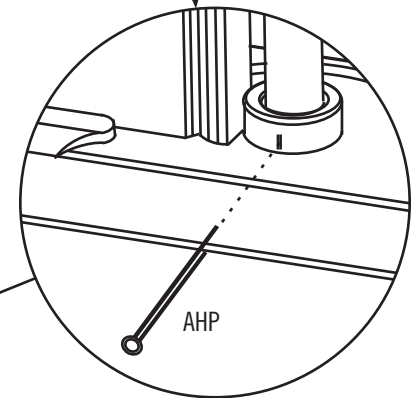
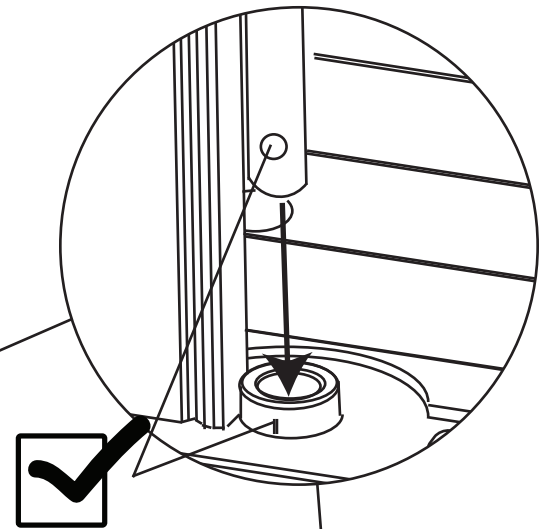
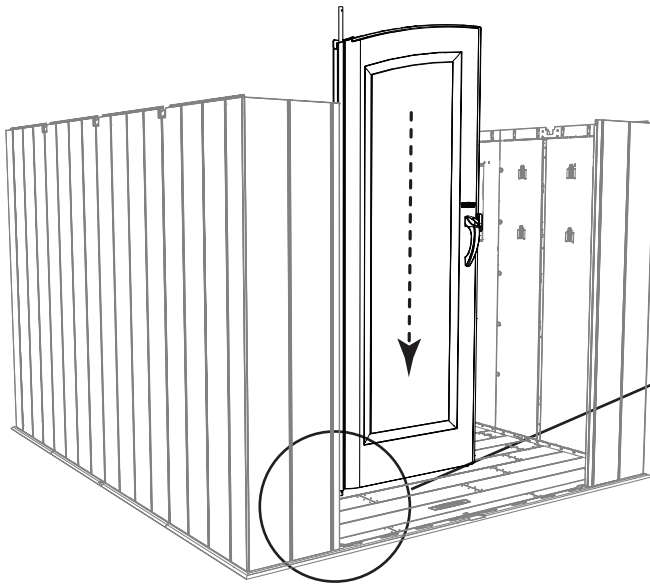

*Note: Repeat this step for the Right Door.
Remarque : Répéter cette étape pour la porte droite.
Nota: Repetir este paso para la puerta derecha.*

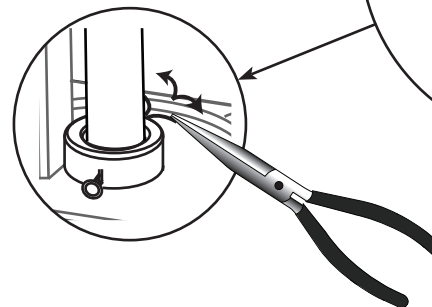
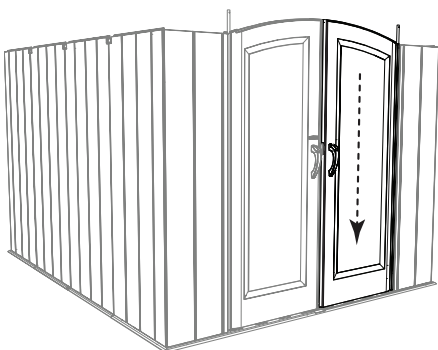

► SECTION 9 (CONTINUED) / SECTION 9 (SUITE) / SECCIÓN 9 (CONTINUACIÓN)

TOOLS AND HARDWARE REQUIRED / OUTILS ET QUINCAILLERIE REQUIS / INSTRUMENTAL Y HERRAJE REQUERIDOS

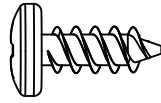

ADZ (x6)

9.2

- Slide the holes in the Entry Gable down over the two Hinge Tubes.
- Faire glisser les trous dans le toit à pignon d'entrée sur les deux tubes.
- Deslizar los agujeros en la fachada de entrada sobre los dos tubos.

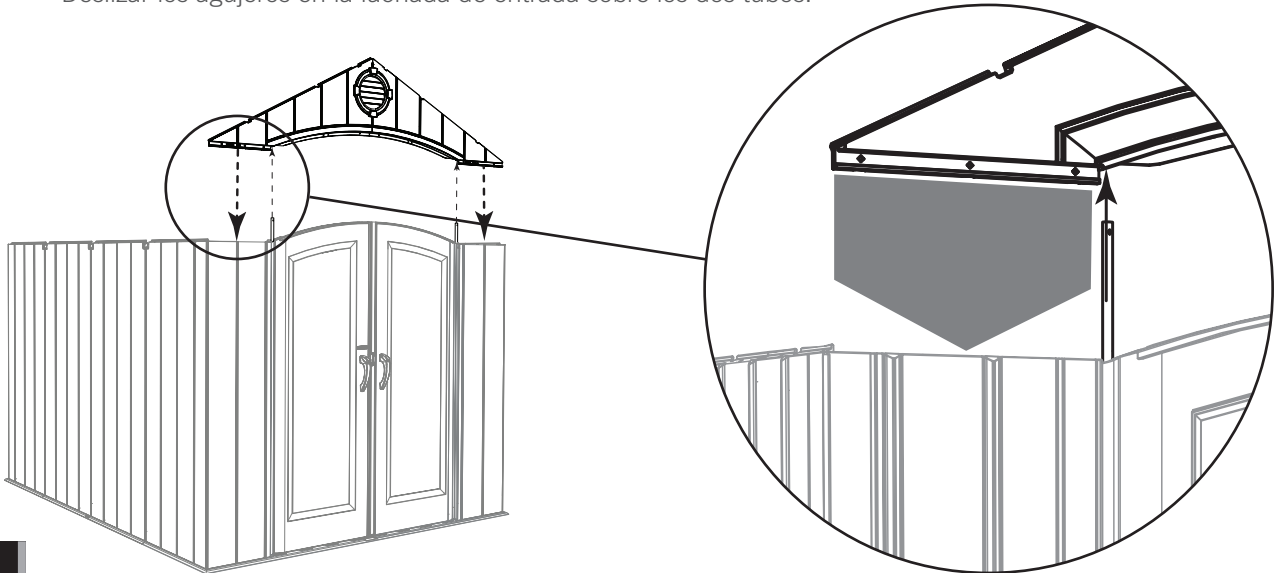

9.3

- Secure the Entry Gable to the Shed using six (6) **Screws (ADZ)**.
- Attacher le toit à pignon d'entrée à l'abri à l'aide de six (6) **vis (ADZ)**.
- Sujetar la Fachada de entrada a la caseta usando seis (6) **tornillos (ADZ)**.

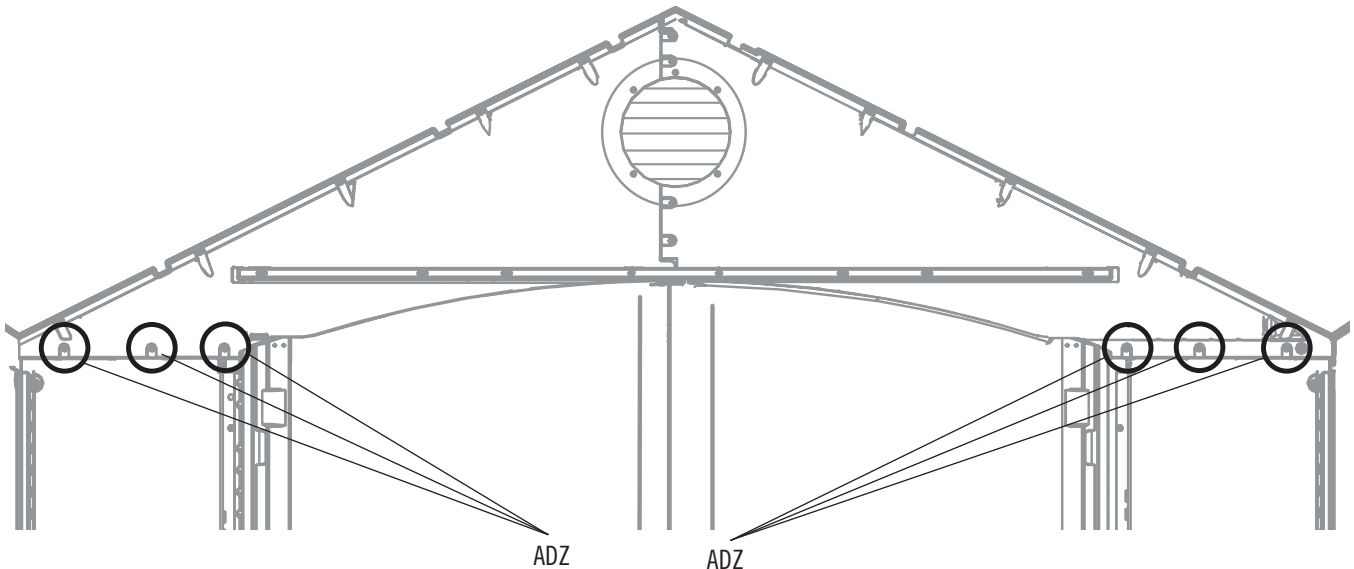

► SECTION 9 (CONTINUED) / SECTION 9 (SUITE) / SECCIÓN 9 (CONTINUACIÓN)

TOOLS AND HARDWARE REQUIRED / OUTILS ET QUINCAILLERIE REQUIS / INSTRUMENTAL Y HERRAJE REQUERIDOS

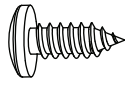

ADX (x4)

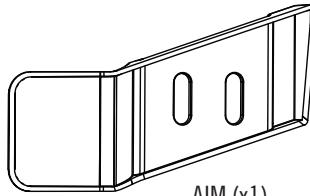

AIM (x1)

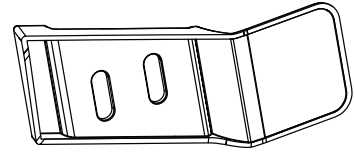

AIC (x1)

9.4

- Attach the **Left (AIC)** and **Right (AIM)** Gap Flaps to the corners of the Doors using the hardware included. **These Flaps simply serve to block out light.**
- Attacher les **rabats gauche (AIC)** et **droit (AIM)** aux portes à l'aide de la quincaillerie incluse. **Ces rabats ne servent que pour empêcher la lumière d'entrer.**
- Sujetar las **tapas de las puertas izquierda (AIC)** y **derecha (AIM)** a las puertas usando el herraje incluido. **Estas tapas sirven sólo para tapar la luz.**

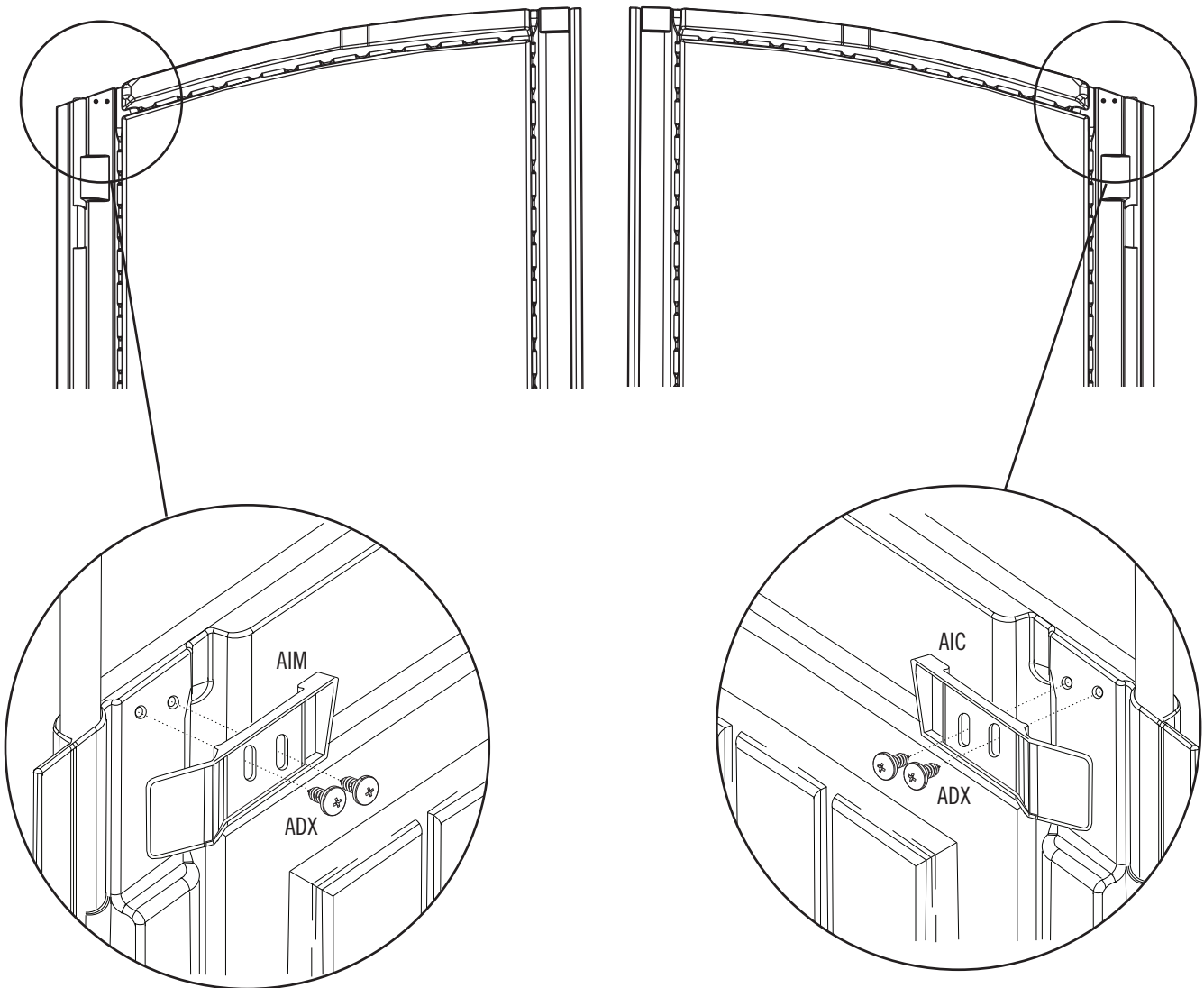



HARDWARE REQUIRED / QUINCAILLERIE REQUISE / HERRAJE REQUERIDO

Hardware Bag / Sac de quincaillerie / Bolsa de herraje

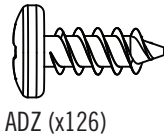

ADZ (x126)

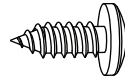

ADX (x24)

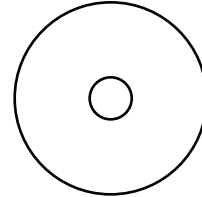

AED (x24)



PARTS REQUIRED / PIÈCES REQUISES / PIEZAS REQUERIDAS

Metal Parts / Pièces en métal / Piezas de metal



AFL (x8)

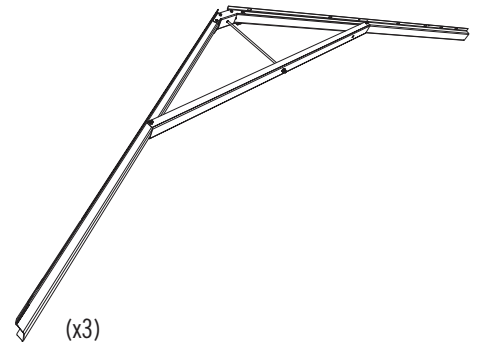

(x3)

Plastic Parts / Pièces en plastique / Piezas de plástico

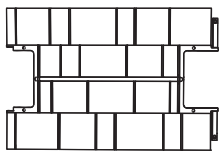

AFY (117) (x3)

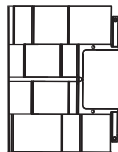

AGG (115) (x1)

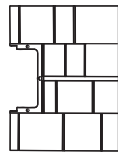

AFW (116) (x1)

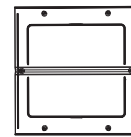

AHC (x4)

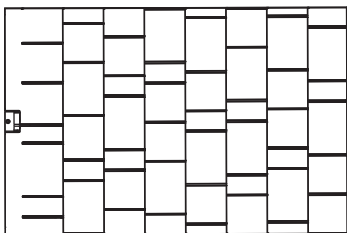

AGQ (x8)

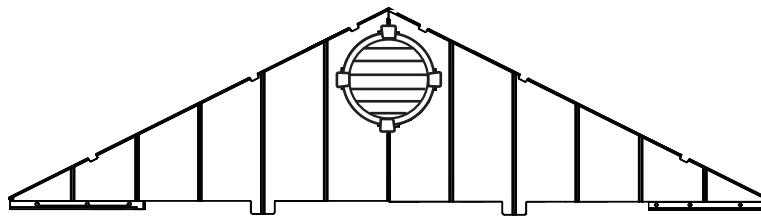

(x1)



TOOLS REQUIRED / OUTILS REQUIS / INSTRUMENTAL REQUERIDO



► SECTION 10 (CONTINUED) / SECTION 10 (SUITE) / SECCIÓN 10 (CONTINUACIÓN)

TOOLS AND HARDWARE REQUIRED / OUTILS ET QUINCAILLERIE REQUIS / INSTRUMENTAL Y HERRAJE REQUERIDOS



10.1

- Set a truss assembly into the notches on the first two opposite wall panels. Set a **roof panel (AGQ)** onto the gable, wall panel, and truss assembly.
- Mettre une ferme dans les encoches des premiers deux panneaux muraux opposés. Mettre un **panneaux de toit (AGQ)** sur le pignon, panneau mural, et la ferme.
- Colocar una cercha dentro de las muescas de los primeros dos paneles de pared opuestos. Colocar un **panel de tejado (AGQ)** sobre la fachada de entrada, panel mural, y la cercha.

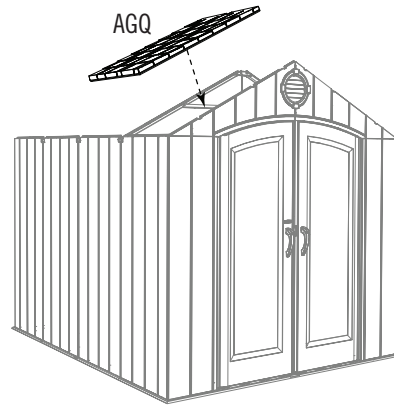
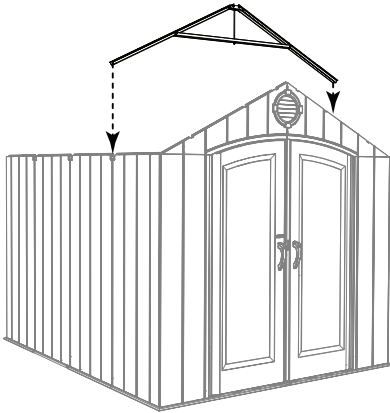

10.2

- The groove at the bottom of the roof panel sets over the top of the wall panel. Ensure the alignment nub fits into the notch in the truss.
- Mettre la rainure au bord inférieur du panneau de toit sur la partie supérieure du panneau mural. Mettre la petite bosse d'alignement dans l'encoche de la ferme.
- Colocar la ranura a lo largo del borde inferior del panel de tejado sobre la parte superior del panel de pared. Encajar el bulbo de alineamiento en la muesca en la cercha.

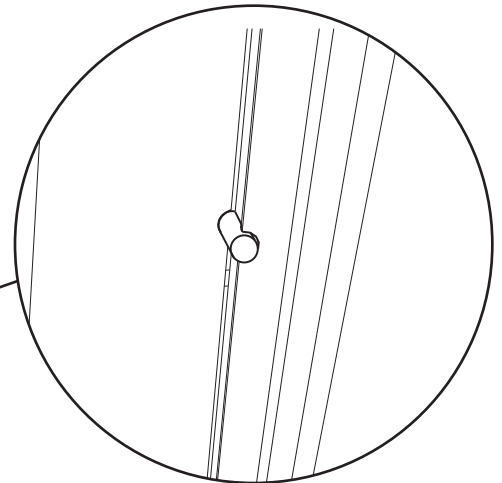
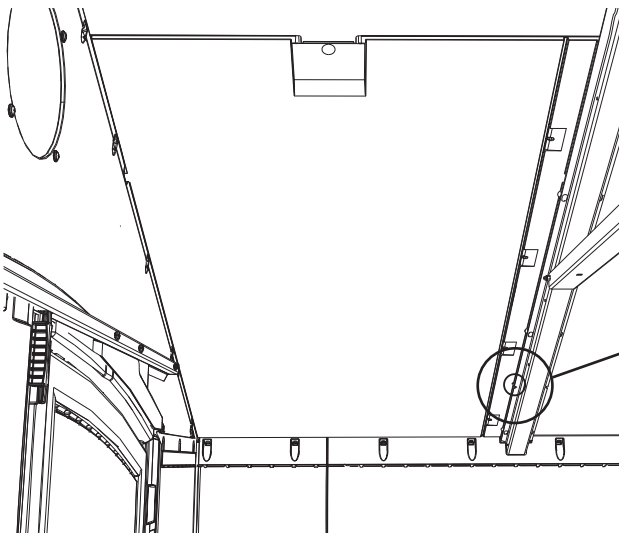

► SECTION 10 (CONTINUED) / SECTION 10 (SUITE) / SECCIÓN 10 (CONTINUACIÓN)

TOOLS AND HARDWARE REQUIRED / OUTILS ET QUINCAILLERIE REQUIS / INSTRUMENTAL Y HERRAJE REQUERIDOS

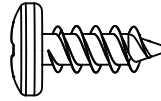

ADZ (x4)

10.3

- Align the four holes in the wall panel with those at the bottom of the roof panel, and insert four (4) **screws (ADZ)** to secure the panel in place.
- Aligner les quatre trous dans le panneau mural avec ceux au bord inférieur du panneau de toit, et insérer quatre (4) **vis (ADZ)** pour attacher le panneau en place.
- Alinear los cuatro agujeros en el panel de pared con los al borde inferior del panel de tejado, e insertar cuatro (4) **tornillos (ADZ)** para sujetarlo en su lugar.

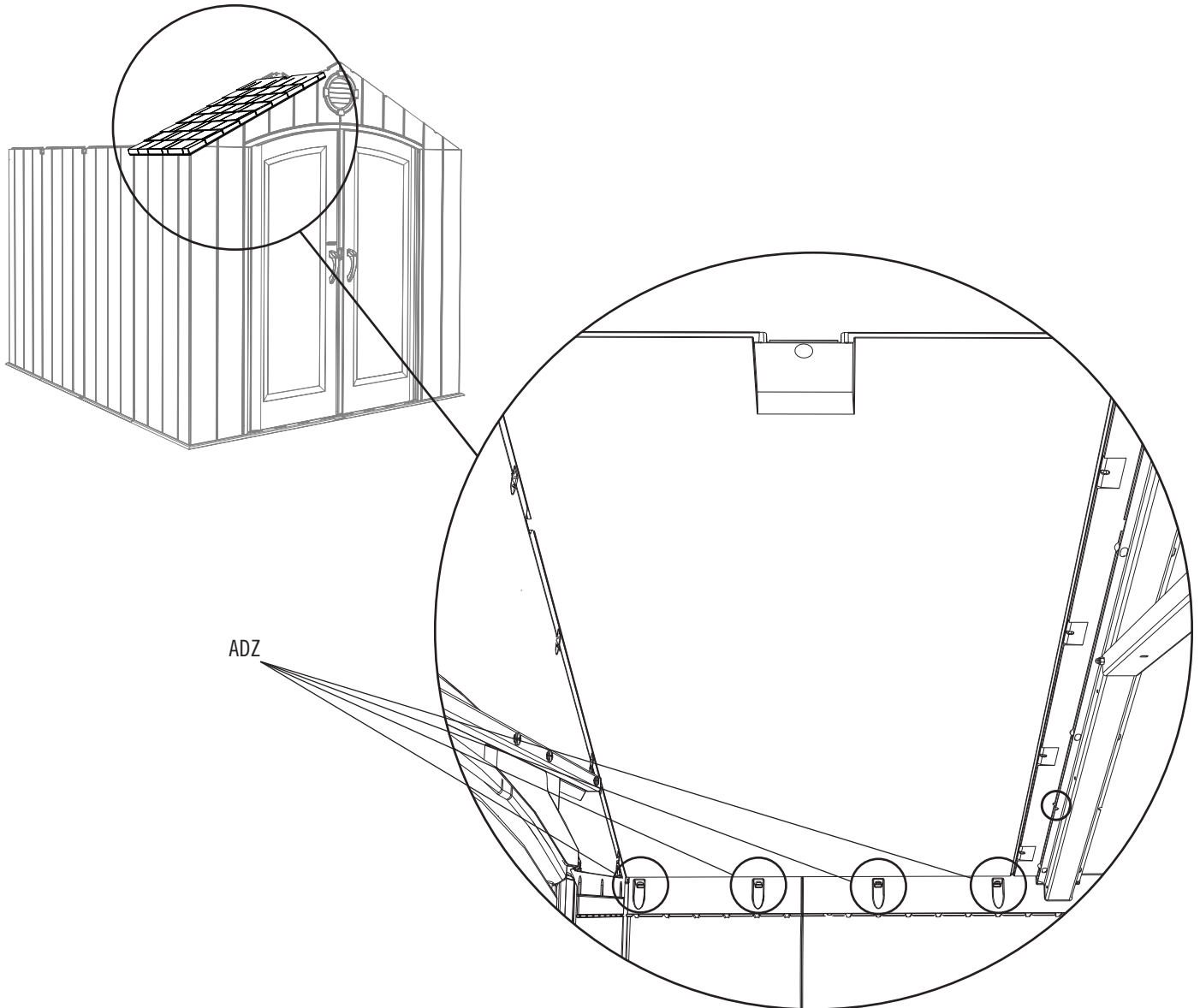

► SECTION 10 (CONTINUED) / SECTION 10 (SUITE) / SECCIÓN 10 (CONTINUACIÓN)

TOOLS AND HARDWARE REQUIRED / OUTILS ET QUINCAILLERIE REQUIS / INSTRUMENTAL Y HERRAJE REQUERIDOS

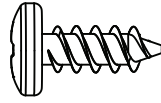

ADZ (x2)

10.4

- Insert the first two **screws (ADZ)** through the gable and into the roof panel at the locations shown. Insert the **roof support (AFL)** into the notches in the gable and between the truss and the roof panel.
- Insérer les premières deux **vis (ADZ)** à travers le pignon et dans le panneau de toit aux emplacements indiqués. Mettre le **support de toit (AFL)** dans les encoches dans le pignon et entre le panneau de toit et la ferme.
- Insertar los primeros dos **tornillos (ADZ)** por la fachada y dentro del panel de tejado a las ubicaciones indicadas. Insertar el **soporte de tejado (AFL)** en las muescas en la fachada y entre la cercha y el panel de tejado.

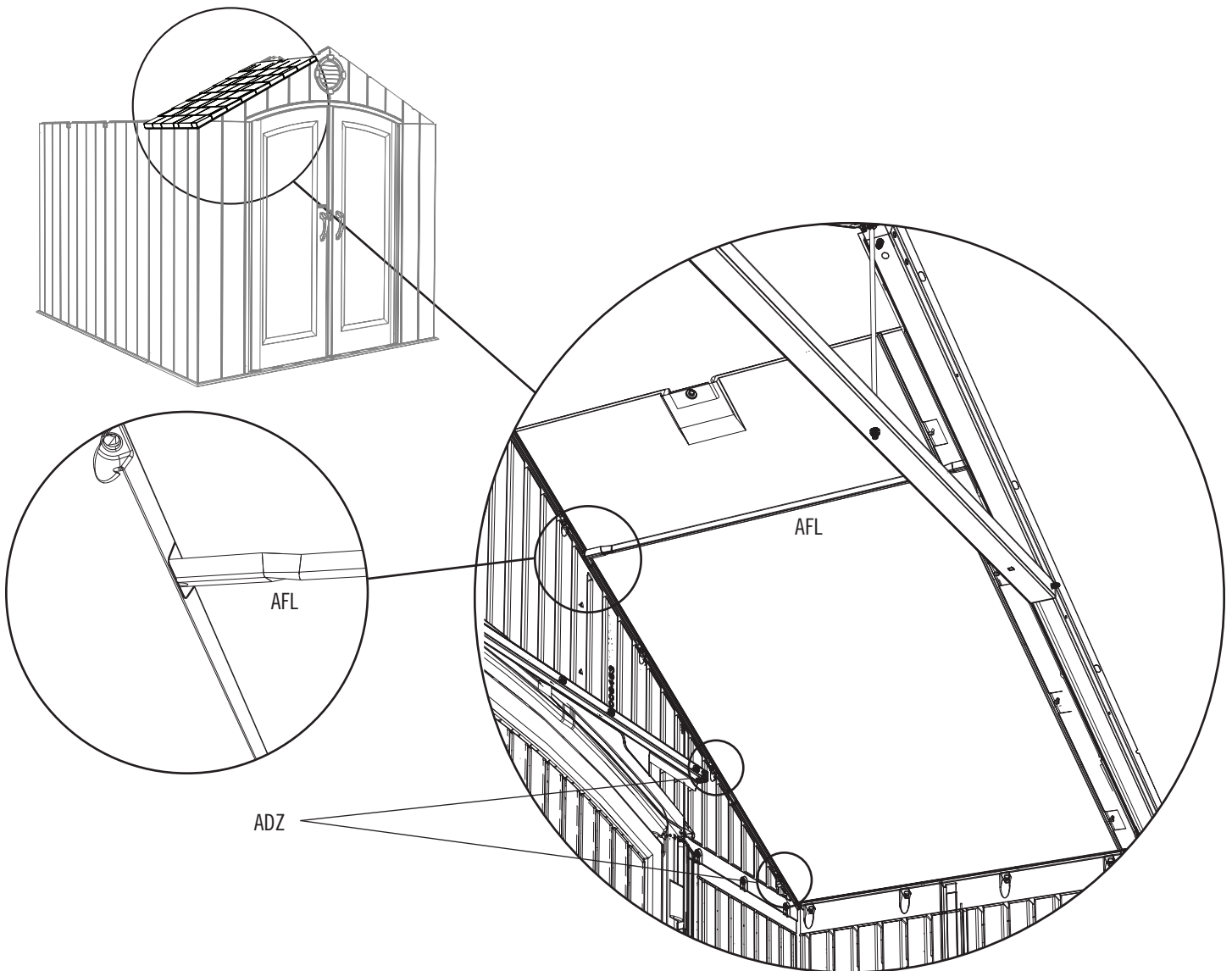

► SECTION 10 (CONTINUED) / SECTION 10 (SUITE) / SECCIÓN 10 (CONTINUACIÓN)

TOOLS AND HARDWARE REQUIRED / OUTILS ET QUINCAILLERIE REQUIS / INSTRUMENTAL Y HERRAJE REQUERIDOS

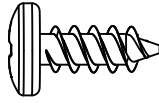

ADZ (x16)

10.5

- Insert five (5) more **screws (ADZ)** to secure the panel in place.
- Insérer cinq (5) **vis (ADZ)** de plus pour attacher le panneau en place.
- Insertar cinco (5) **tornillos (ADZ)** más para sujetar el panel en su lugar.

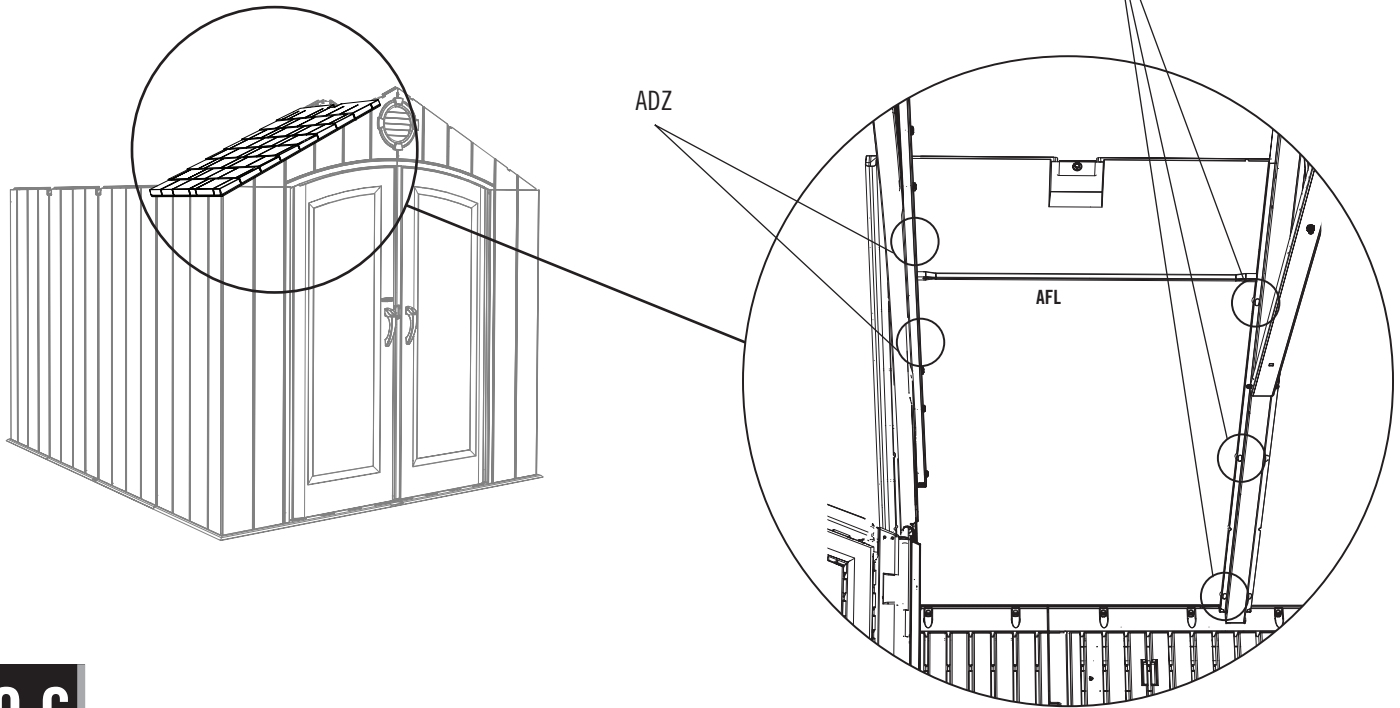

10.6

- Repeat steps 10.2–10.5 For the second front roof panel.
- Répéter les étapes 10.2 – 10.5 pour le deuxième panneau de toit avant.
- Repetir los pasos 10.2–10.5 para el segundo panel de tejado delantero.

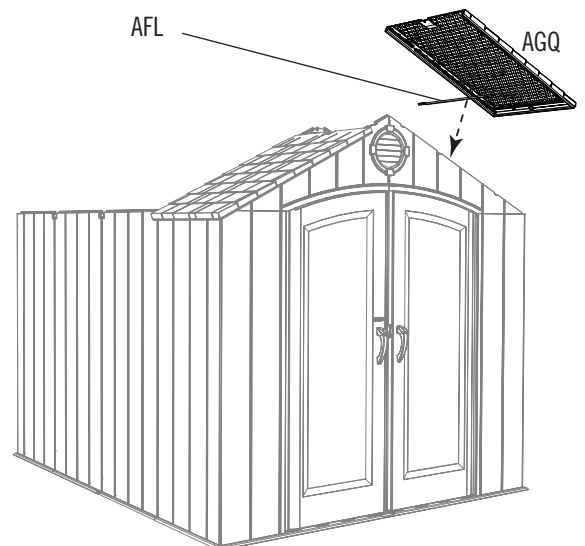

► SECTION 10 (CONTINUED) / SECTION 10 (SUITE) / SECCIÓN 10 (CONTINUACIÓN)

TOOLS AND HARDWARE REQUIRED / OUTILS ET QUINCAILLERIE REQUIS / INSTRUMENTAL Y HERRAJE REQUERIDOS

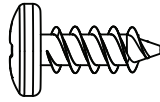

ADZ (x40)

10.7

- Attach the next six roof panels in a similar way as the first two.
- Attacher les seis panneaux de toit suivants dans une façon similaire que les premiers panneaux.
- Sujetar los siguientes seis paneles de tejado en una manera similar que los primeros dos.

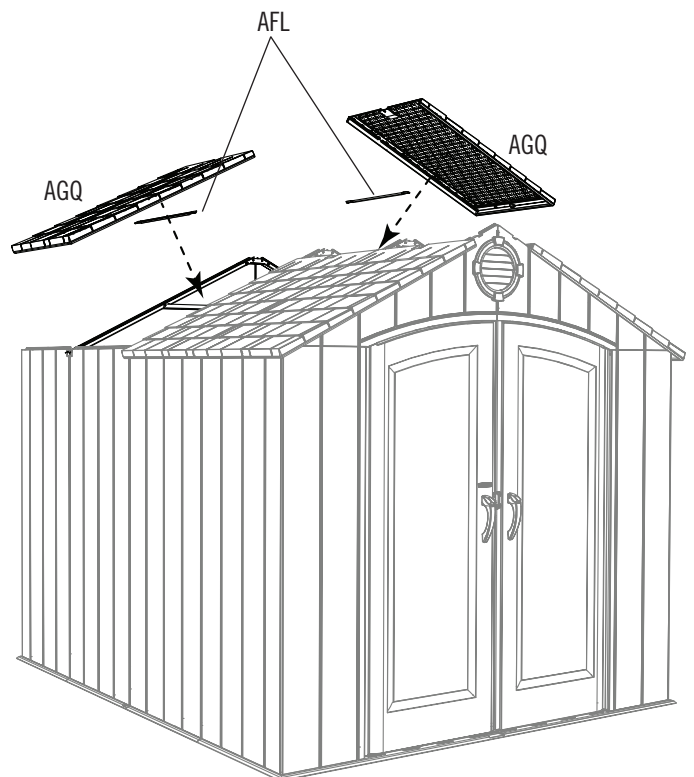
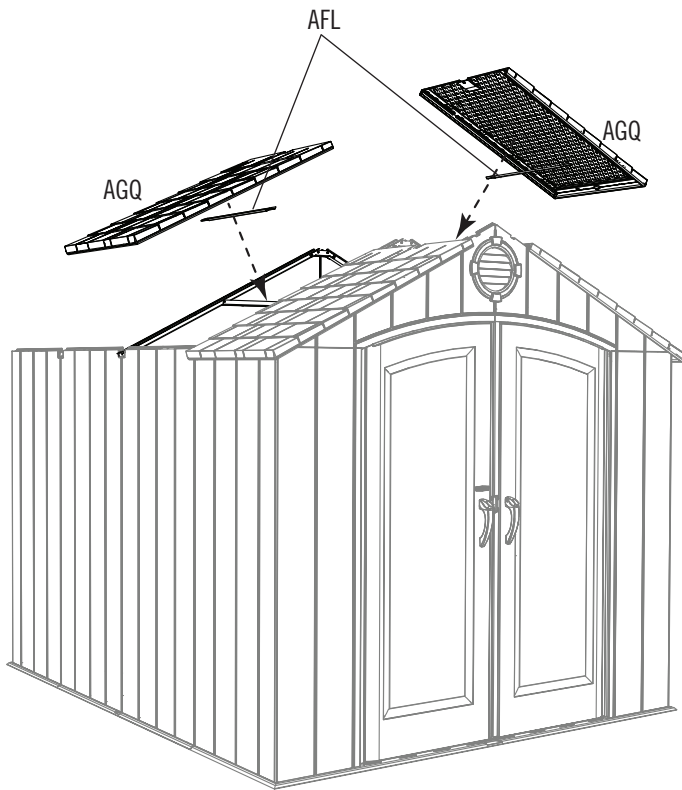

► SECTION 10 (CONTINUED) / SECTION 10 (SUITE) / SECCIÓN 10 (CONTINUACIÓN)

TOOLS AND HARDWARE REQUIRED / OUTILS ET QUINCAILLERIE REQUIS / INSTRUMENTAL Y HERRAJE REQUERIDOS

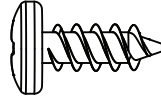

ADZ (x14)

10.8

- Attach the rear gable to the shed using fourteen (14) **screws (ADZ)**.
- Attacher le pignon arrière à l'abri à l'aide de quatorze (14) **vis (ADZ)**.
- Sujetar la fachada trasera a la caseta usando catorce (14) **tornillos (ADZ)**.

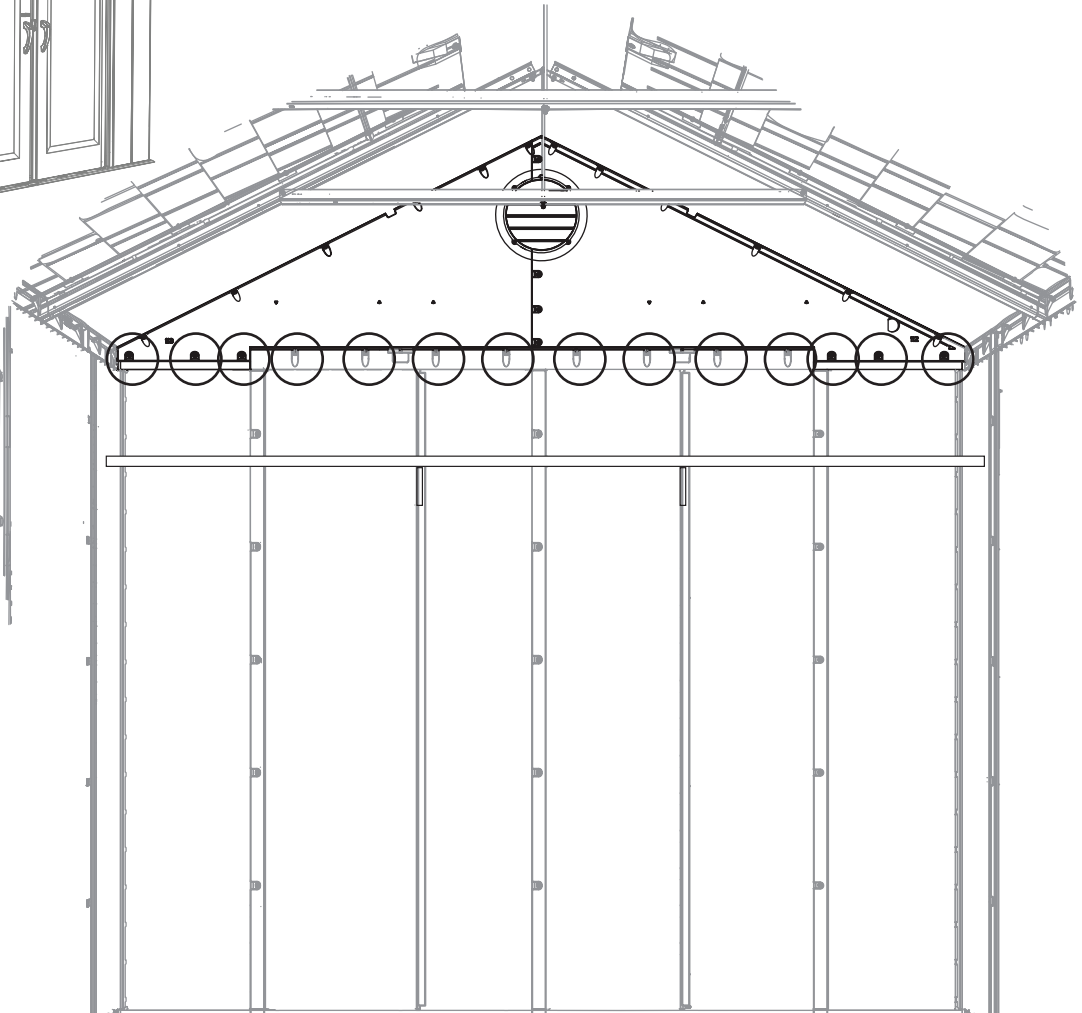
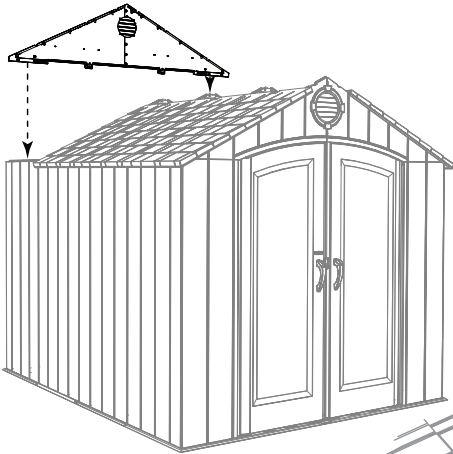

► SECTION 10 (CONTINUED) / SECTION 10 (SUITE) / SECCIÓN 10 (CONTINUACIÓN)

TOOLS AND HARDWARE REQUIRED / OUTILS ET QUINCAILLERIE REQUIS / INSTRUMENTAL Y HERRAJE REQUERIDOS

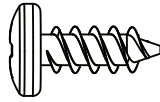

ADZ (x22)

10.9

- Attach the last two roof panels to the shed in the same way you did the first two.
- Attacher les derniers deux panneaux de toit à l'abri dans la même façon que les premiers deux.
- Sujetar los últimos dos paneles de tejado a la caseta en la misma manera que los primeros dos.

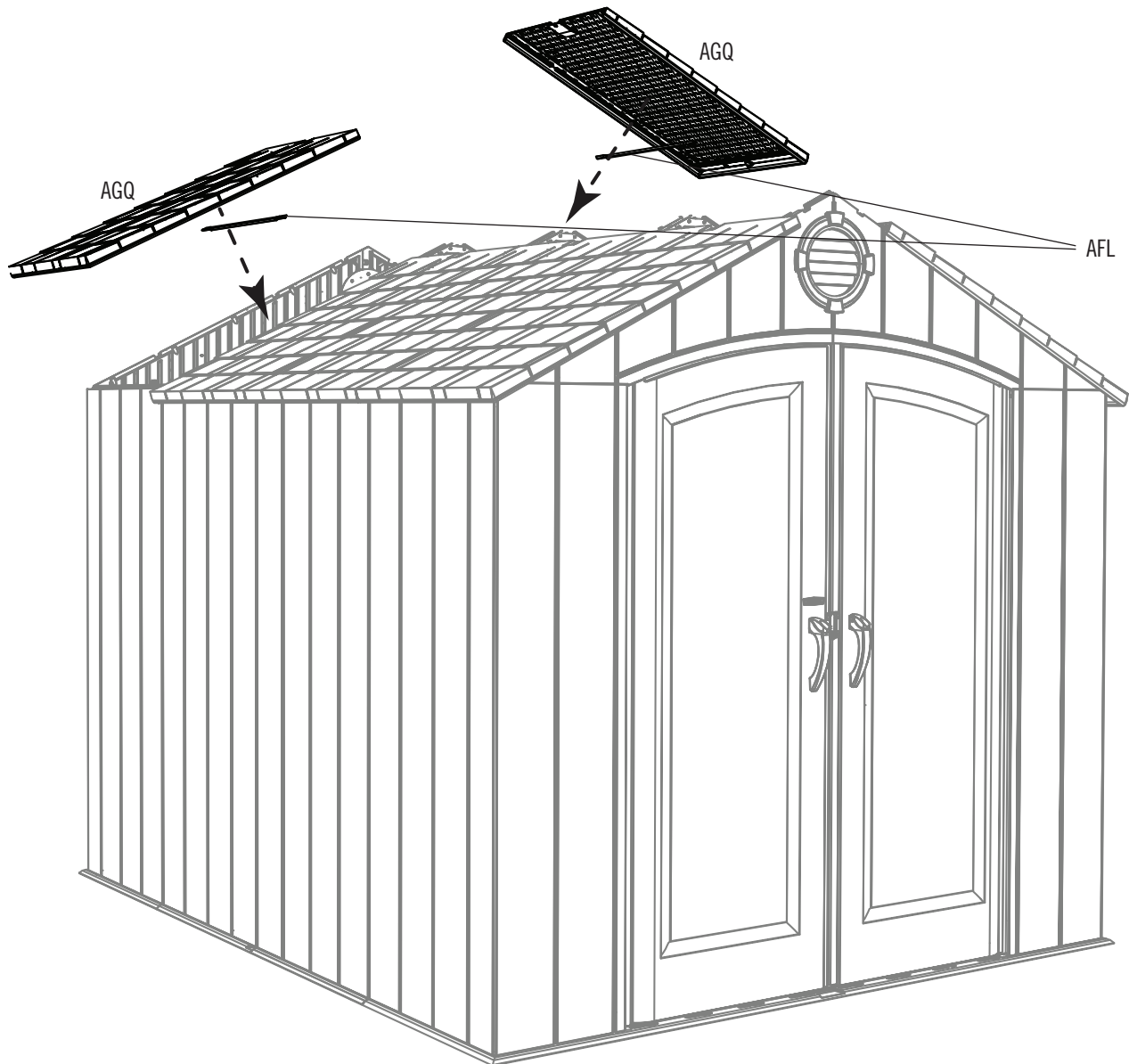

► SECTION 10 (CONTINUED) / SECTION 10 (SUITE) / SECCIÓN 10 (CONTINUACIÓN)

TOOLS AND HARDWARE REQUIRED / OUTILS ET QUINCAILLERIE REQUIS / INSTRUMENTAL Y HERRAJE REQUERIDOS

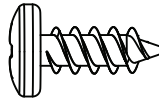

ADZ (x28)

10.10

- Starting at the front, attach the roof caps to the shed using the hardware included.
- En commençant à la partie avant, attacher les chapeaux à l'abri à l'aide de la quincaillerie incluse.
- Empezando a la parte delantera, sujetar las cumbreras a la caseta usando el herraje incluido.



Note: The ends of the roof caps overlap one another.
Remarque : Les extrémités des chapeaux se chevauchent.
Nota: Los extremos de las cumbreras se solapan.

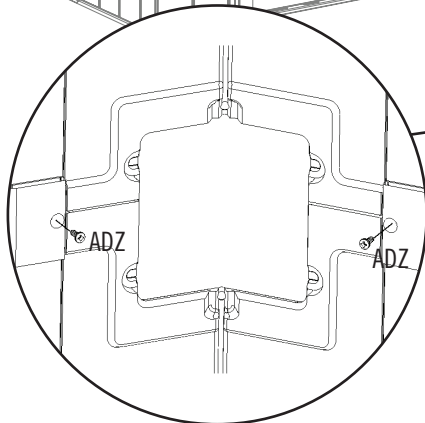
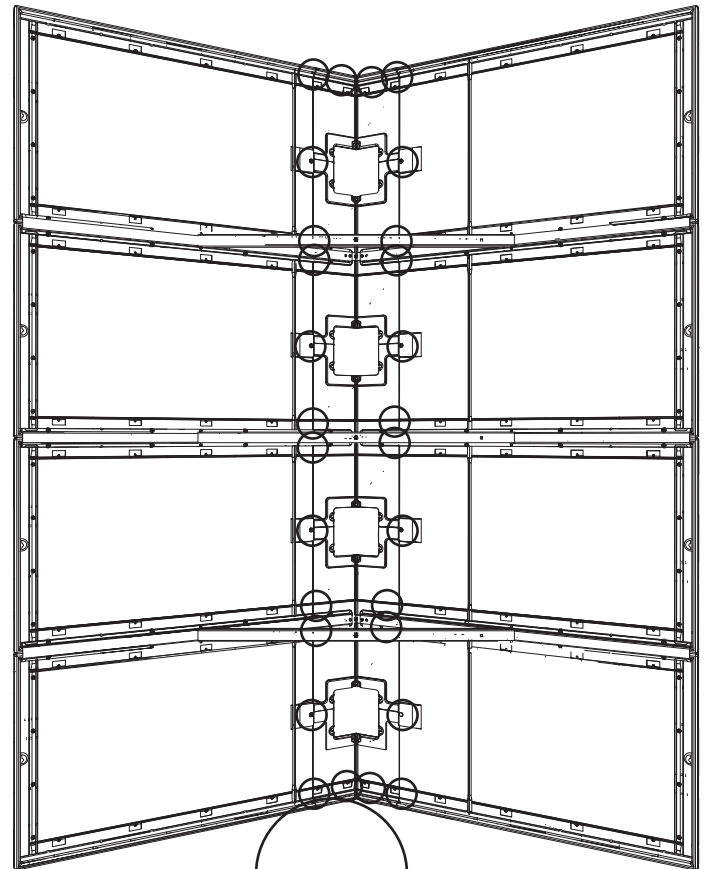
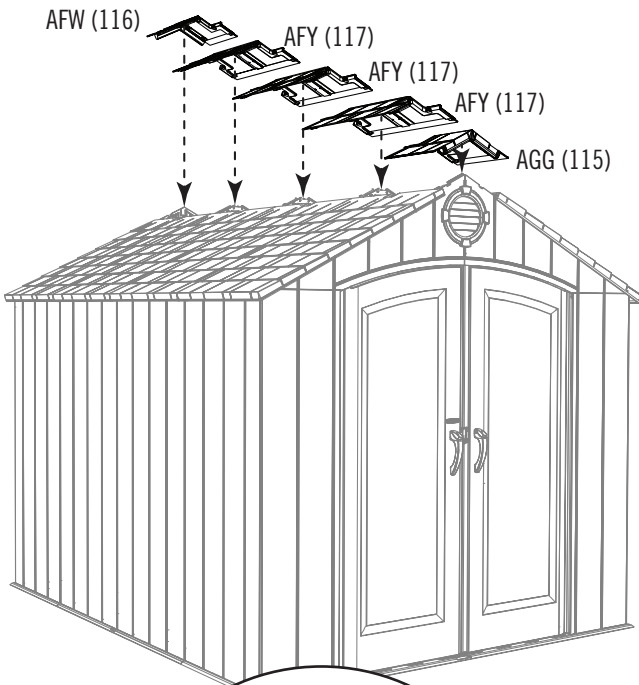

► SECTION 10 (CONTINUED) / SECTION 10 (SUITE) / SECCIÓN 10 (CONTINUACIÓN)

TOOLS AND HARDWARE REQUIRED / OUTILS ET QUINCAILLERIE REQUIS / INSTRUMENTAL Y HERRAJE REQUERIDOS

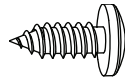

ADX (x24)

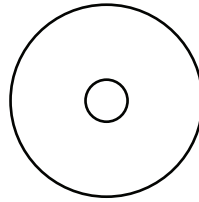

AED (x24)

10.11



- Fold the skylights (AHC), and attach them to the roof using six (6) screws (ADX) and washers (AED) for each skylight.
- Plier les lucarnes (AHC), et attacher-les au toit à l'aide de six (6) vis (ADX) et rondelles (AED) pour chaque lucarne.
- Doblar los tragaluces (AHC), y sujetarlos al tejado usando seis (6) tornillos (ADX) y rondanas (AED) para cada tragaluz.

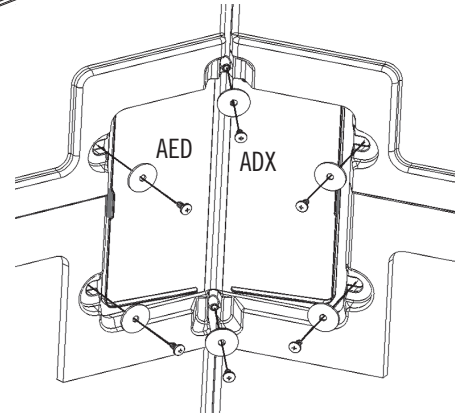
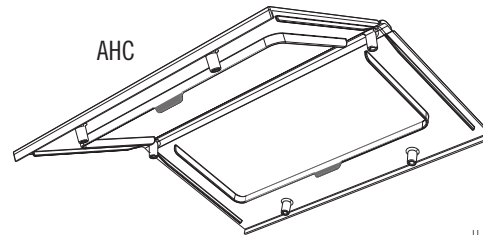
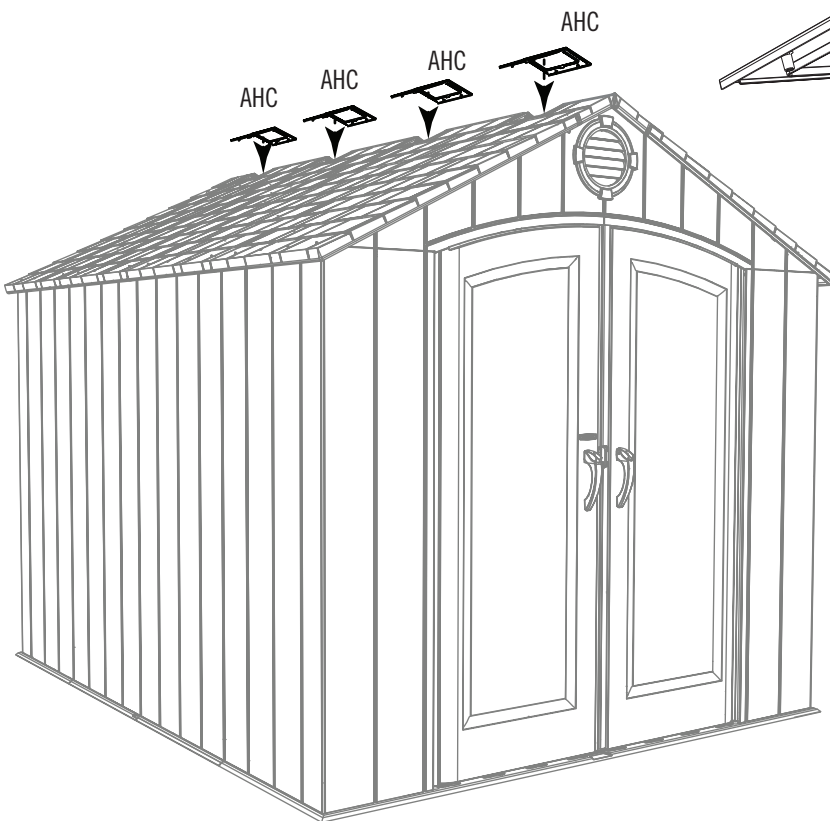

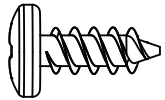
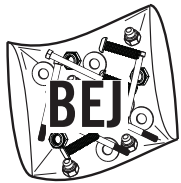

HARDWARE REQUIRED / QUINCAILLERIE REQUISE / HERRAJE REQUERIDO

Hardware Bag / Sac de quincaillerie / Bolsa de herraje

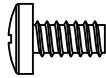

ADZ (x4)



ADY (x1)

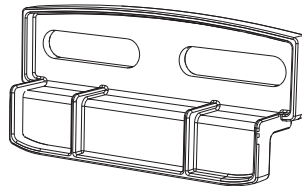

AIS (x2)

PARTS REQUIRED / PIÈCES REQUISES / PIEZAS REQUERIDAS

Plastic Parts / Pièces en plastique / Piezas de plástico

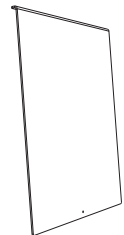

AHE (x1)

TOOLS REQUIRED / OUTILS REQUIS / INSTRUMENTAL REQUERIDO

► SECTION 11 (CONTINUED) / SECTION 11 (SUITE) / SECCIÓN 11 (CONTINUACIÓN)

TOOLS AND HARDWARE REQUIRED / OUTILS ET QUINCAILLERIE REQUIS / INSTRUMENTAL Y HERRAJE REQUERIDOS

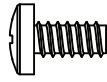

ADY (x1)

11.1

- Peel off the protective backing from both sides of the **Window Pane (AHE)**.
- Retirer la pellicule protectrice des deux côtés du **carreau (AHE)**.
- Retirar el protector de plástico de las dos caras de la **hoja de ventana (AHE)**.

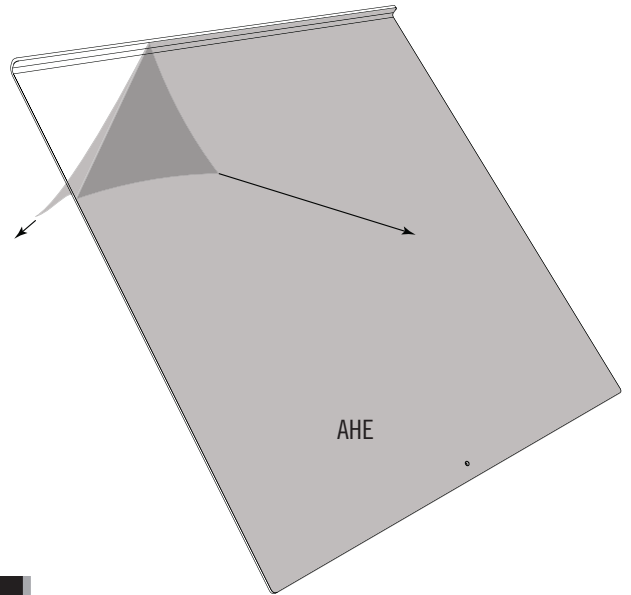

11.2

- With the curved edge at the top and facing toward you, slide the Window Pane down into the opening.
- Avec le bord courbé vers le haut et vous faisant face, faire glisser le carreau en place.
- Con el borde curvado hacia arriba y el interior, deslizar la hoja en su lugar.

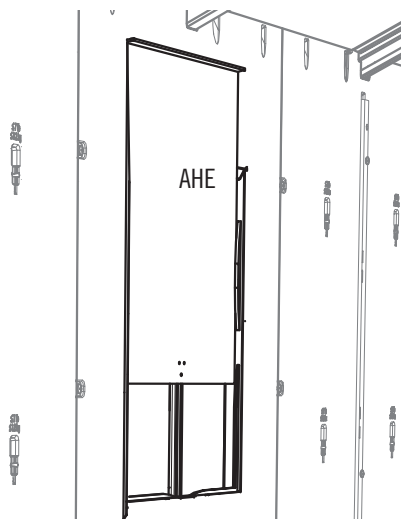

11.3

- Insert a **Screw (ADY)** into the hole at the bottom of the Window. **This helps keep the Window Pane up when open.**
- Insérer une **vis (ADY)** dans le trou au bord inférieur du carreau. **Cela aide à maintenir le carreau en haut lorsqu'il est ouvert.**
- Introducir un **tornillo (ADY)** en el agujero al borde inferior de la hoja. **Esto ayuda a prevenir la cierre de la hoja.**

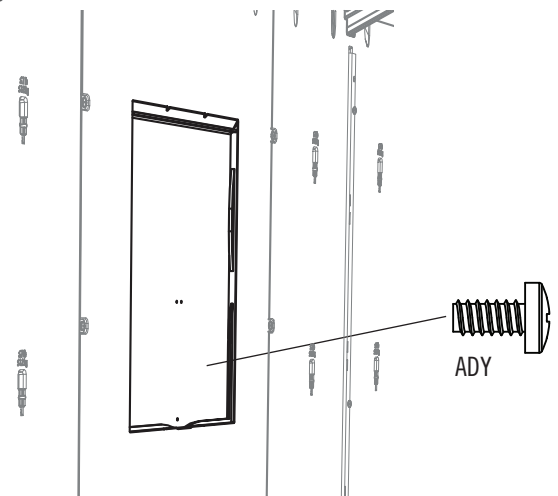

► SECTION 11 (CONTINUED) / SECTION 11 (SUITE) / SECCIÓN 11 (CONTINUACIÓN)

TOOLS AND HARDWARE REQUIRED / OUTILS ET QUINCAILLERIE REQUIS / INSTRUMENTAL Y HERRAJE REQUERIDOS

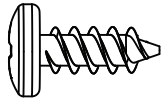

ADZ (x4)

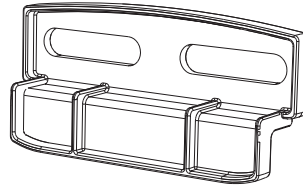

AIS (x2)

11.4

- Attach the two (2) **Window Latches (ADY)** at the top corners of the Panel opening.
- Attacher les deux (2) **loquets (ADY)** aux angles supérieurs de l'ouverture du panneau.
- Sujetar los dos (2) **cerrojos (ADY)** a las esquinas superiores de la abertura del panel.

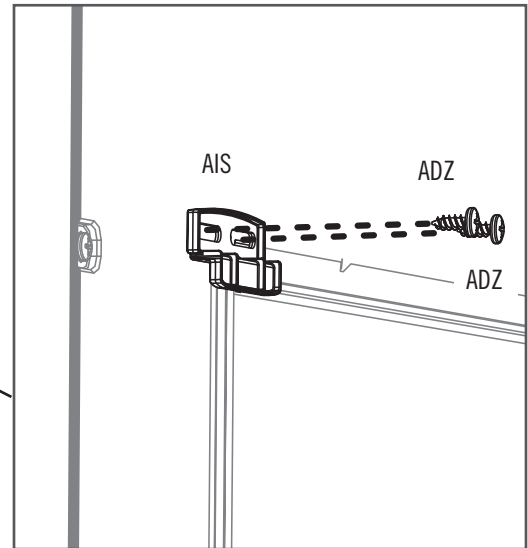
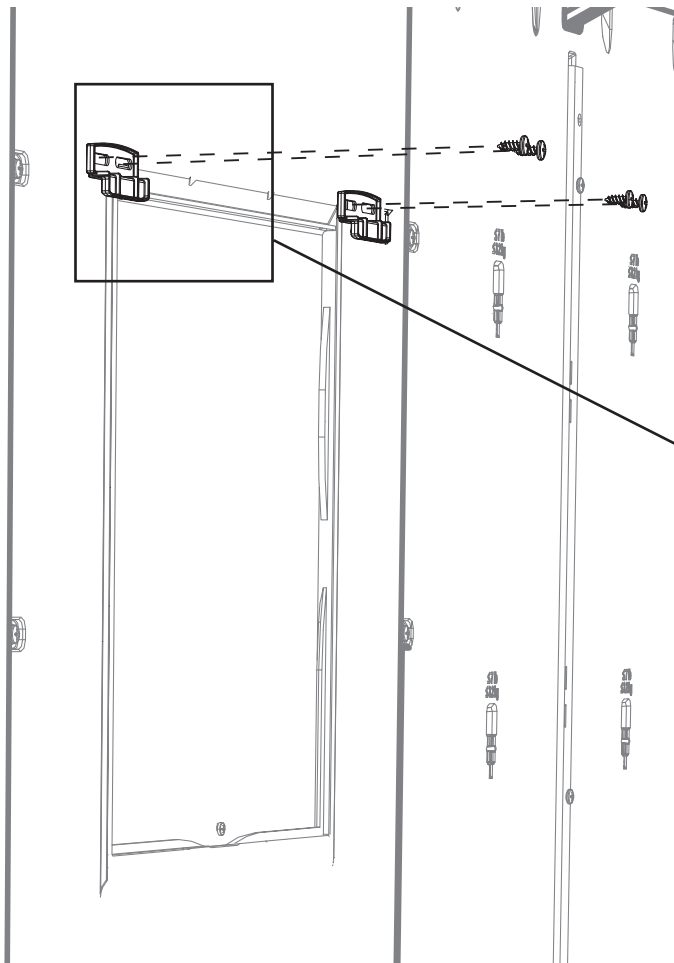

! *Note: The Latch should move freely.*
Remarque : Le loquet doit se déplacer librement.
Nota: El cerrojo debe mover libremente.

12

WALL HOOK INSTALLATION / INSTALLATION DES CROCHETS MURAUX / INSTALACIÓN DE LOS GANCHOS MURALES



HARDWARE REQUIRED / QUINCAILLERIE REQUISE / HERRAJE REQUERIDO

Wall Hook Bag / Sac de crochets muraux / Bolsa de ganchos murales

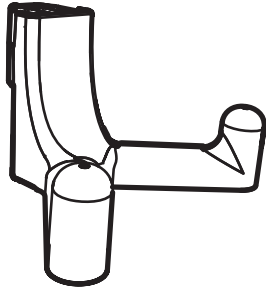

EDL (x6)



PARTS REQUIRED / PIÈCES REQUISES / PIEZAS REQUERIDAS



TOOLS REQUIRED / OUTILS REQUIS / INSTRUMENTAL REQUERIDO

► SECTION 12 (CONTINUED) / SECTION 12 (SUITE) / SECCIÓN 12 (CONTINUACIÓN)

TOOLS AND ACCESSORIES REQUIRED / OUTILS ET ACCESSOIRES REQUIS / INSTRUMENTAL Y ACCESORIOS REQUERIDOS

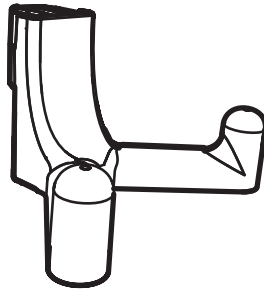

EDL (x6)

12.1

- Insert the six (6) **wall hooks (EDL)** into any of the notches in the wall panels (either side of the shed). Then push downward to lock them in place.
- Insérer les six (6) **crochets muraux (EDL)** dans les fentes des panneaux muraux (peu importe le côté de la remise). Pousser vers le bas pour les fixer en place.
- Insertar los seis (6) **ganchos murales (EDL)** en cualquiera de las muescas en los paneles murales (de cualquiera lado de la caseta). Después, presionar hacia abajo para fijarlos en su lugar.



WARNING

The total weight on a wall hook should not exceed 7 lb (3,2 kg) nor more than 30 lb (14 kg) on a wall panel. Failure to follow this warning could result in property damage and/or personal injury.



AVERTISSEMENT

Le poids total sur un crochet mural ne devrait pas excéder ≈3,2 kg (7 lb) ou plus de ≈14 kg (30 lb) sur un panneau mural. Le non-respect de cet avertissement peut entraîner des dommages à la propriété et/ou des blessures graves.



ADVERTENCIA

El peso total en un gancho mural no debe exceder de 7 lb (3.2 kg) ni más de 30 lb (14 kg) en un panel mural. El no seguir esta advertencia puede resultar en daños a la propiedad y/o en lesiones graves personales.

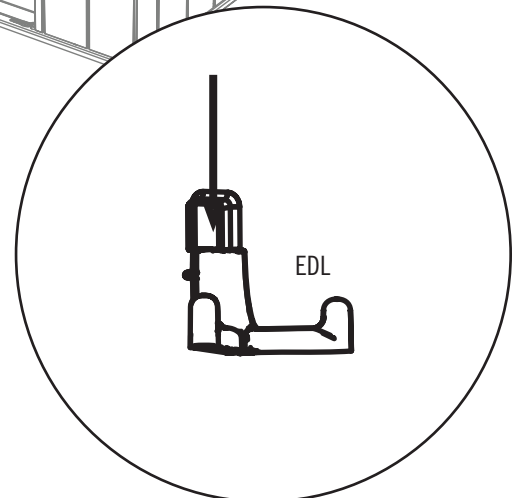
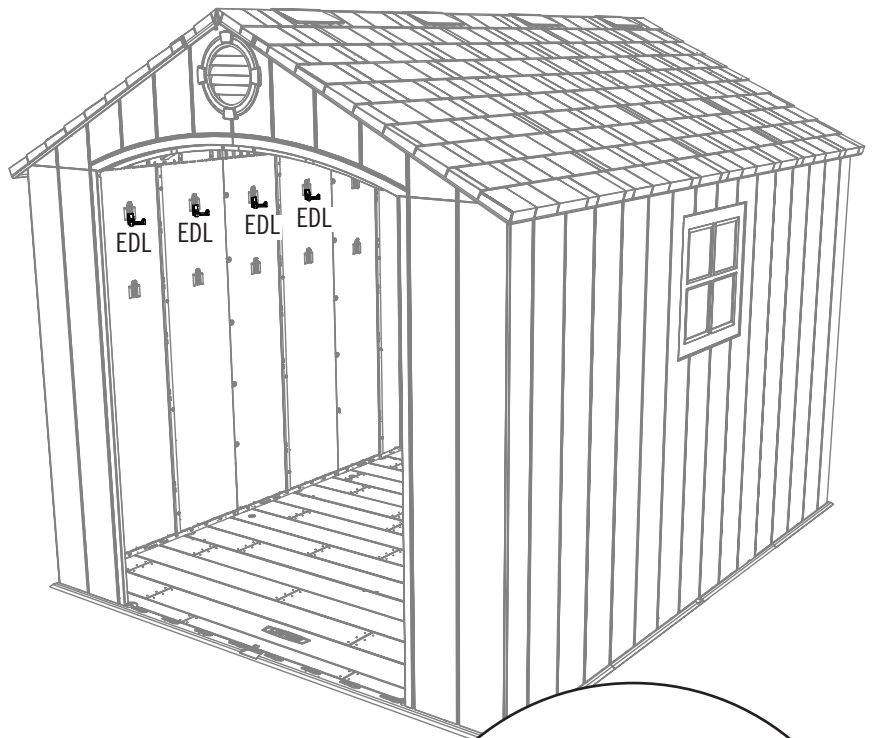

13

DOOR ALIGNMENT / ALIGNEMENT DES PORTES / ALINEACIÓN DE LAS PUERTAS



HARDWARE REQUIRED / QUINCAILLERIE REQUISE / HERRAJE REQUERIDO



PARTS REQUIRED / PIÈCES REQUISES / PIEZAS REQUERIDAS

Plastic Parts / Pièces en plastique / Piezas de plástico

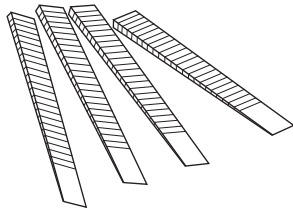

AIX (x4)



TOOLS REQUIRED / OUTILS REQUIS / INSTRUMENTAL REQUERIDO

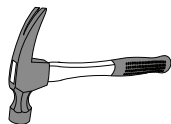

► SECTION 13 (CONTINUED) / SECTION 13 (SUITE) / SECCIÓN 13 (CONTINUACIÓN)

TOOLS AND HARDWARE REQUIRED / OUTILS ET QUINCAILLERIE REQUIS / INSTRUMENTAL Y HERRAJE REQUERIDOS

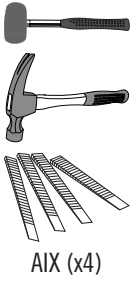

13.1

- If the doors are not level, follow the steps on this page or the next to even them out.
- Si les portes ne sont pas de niveau l'une avec l'autre, suivre les étapes dans cette page ou la suivante pour les niveler.
- Si las puertas no están niveladas, seguir los pasos en esta página o la siguiente para nivelarlas.

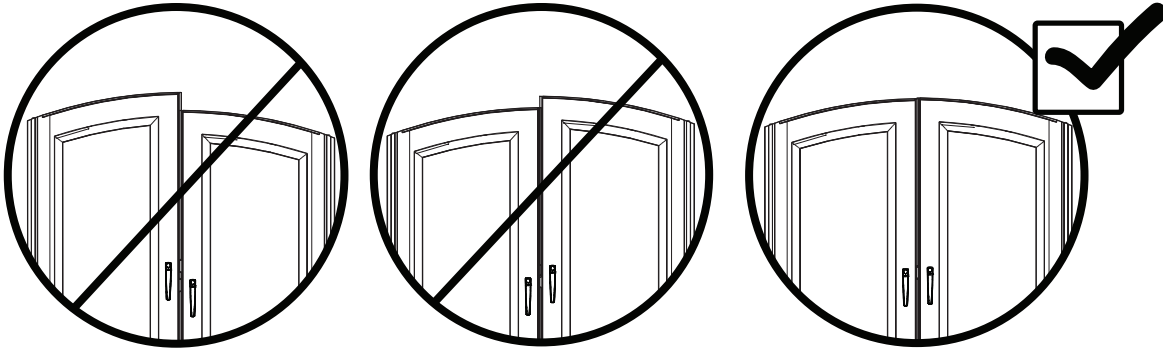

13.2

- If the left door is higher, insert a **shim (AIX)** underneath the bushing of the hinge tube of the right door until the doors are the same height. **Break off any excess shim.**
- Si la porte gauche est plus haute, insérer une **cale (AIX)** sous la bague du tube de charnière de la porte droite jusqu'à ce que les portes restent à la même hauteur. **Détacher de l'excès des cales.**
- Si la puerta izquierda es más alta, insertar una **cuña (AIX)** debajo el cosquillo del tubo de bisagra de la puerta derecha hasta que las puertas queden a la misma altura. **Quebrantar cualquier exceso de las cuñas.**

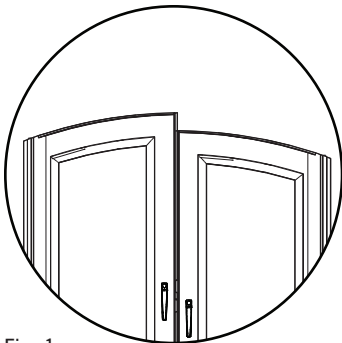

Fig. 1

+

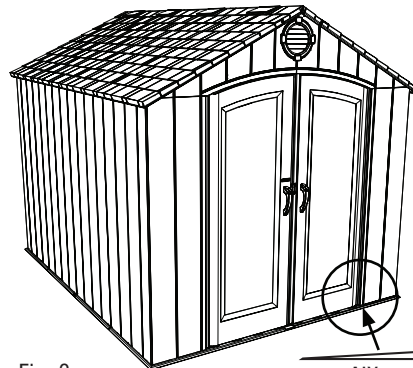

Fig. 2

=

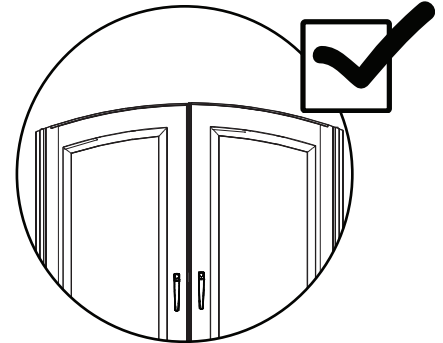
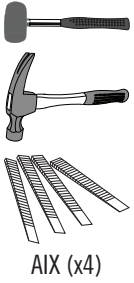

Fig. 3

► SECTION 13 (CONTINUED) / SECTION 13 (SUITE) / SECCIÓN 13 (CONTINUACIÓN)

TOOLS AND HARDWARE REQUIRED / OUTILS ET QUINCAILLERIE REQUIS / INSTRUMENTAL Y HERRAJE REQUERIDOS



13.3

- If the right door is higher, insert a **shim (AIX)** underneath the bushing of the hinge tube of the left door until the doors are the same height. **Break off any excess shim.**
- Si la porte droite est plus haute, insérer une **cale (AIX)** sous la bague du tube de charnière de la porte gauche jusqu'à ce que les portes restent à la même hauteur. **Détacher de l'excès des cales.**
- Si la puerta derecha es más alta, insertar una **cuña (AIX)** debajo el cosquillo del tubo de bisagra de la puerta izquierda hasta que las puertas queden a la misma altura. **Quebrantar cualquier exceso de las cuñas.**

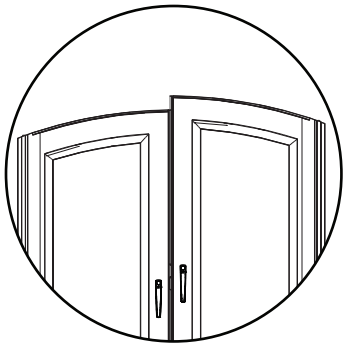

Fig. 1

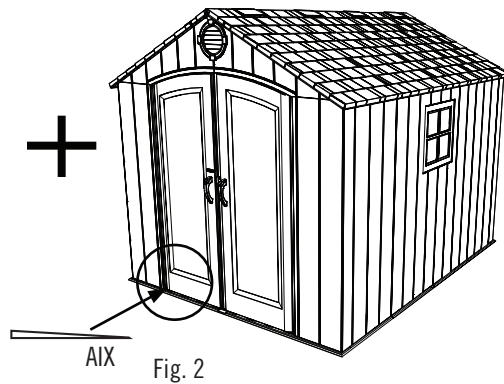

Fig. 2

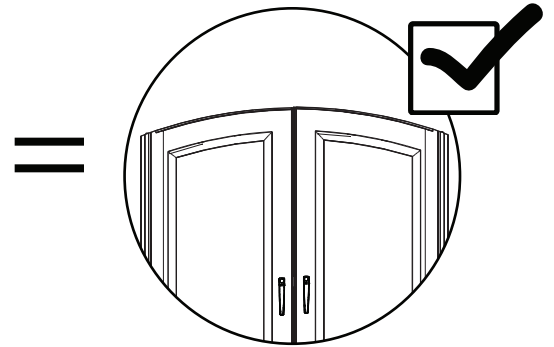

Fig. 3



HARDWARE REQUIRED / QUINCAILLERIE REQUISE / HERRAJE REQUERIDO

*NO HARDWARE OR PARTS INCLUDED FOR THIS SECTION
AUCUNE QUINCAILLERIE OU PIÈCE INCLUSE POUR CETTE SECTION
NINGÚN HERRAJE O PIEZA INCLUIDO PARA ESTA SECCIÓN*



PARTS REQUIRED / PIÈCES REQUISES / PIEZAS REQUERIDAS

*NO HARDWARE OR PARTS INCLUDED FOR THIS SECTION
AUCUNE QUINCAILLERIE OU PIÈCE INCLUSE POUR CETTE SECTION
NINGÚN HERRAJE O PIEZA INCLUIDO PARA ESTA SECCIÓN*



TOOLS REQUIRED / OUTILS REQUIS / INSTRUMENTAL REQUERIDO

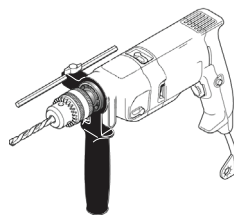
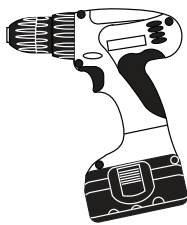
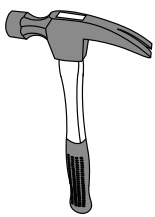

7/16 in/po (≈11 mm)



5/16" (≈8 mm) Wood Drill Bit
5/16 po (≈8 mm) Mèche à bois
5/16 in (≈8 mm) Broca para madera



5/16" (≈8 mm) Masonry Drill Bit
5/16 po (≈8 mm) Mèche à maçonnerie
5/16 in (≈8 mm) Broca para albañilería

▶ SECTION 14 (CONTINUED) / SECTION 14 (SUITE) / SECCIÓN 14 (CONTINUACIÓN)

FOR A CONCRETE PLATFORM / PARA UNA PLATAFORMA DE CONCRETO / POUR UNE PLATE-FORME EN BÉTON

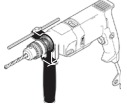

5/16 in/po
(≈8 mm)

ANCHORING TO A CONCRETE PLATFORM L'ANCRAGE DE L'ABRI À UNE PLATE-FORME EN BÉTON EL ANCLAJE DE LA CASETA A UNA PLATAFORMA DE CONCRETO

14.1

- If you plan on anchoring your shed to a concrete platform, you must purchase the correct anchoring hardware. We recommend using a hammer drill, 5/16" (≈8 mm) masonry bit, eight (8) 3/8" x 2" (≈10 mm x 5 cm) Concrete Screws and eight (8) 3/8" x 1" (≈10 mm x 2,5 cm) Fender Washers. **Do not exceed a 3/8" (≈10 mm) diameter screw. Refer to your local hardware store for this hardware.**
- Si la plate-forme est faite de béton, il faut acheter la quincaillerie d'ancrage correcte. Nous recommandons d'utiliser une perceuse de percussion, une mèche à maçonnerie de ≈8 mm (5/16 po), huit (8) vis d'ancrage à béton de ≈10 mm x 5 cm (3/8 x 2 po) et huit (8) rondelles de protection de ≈10 mm x 2,5 cm (3/8 x 1 po). **Ne pas dépasser pas un diamètre de 10 mm (3/8 po). La quincaillerie du coin aura ces accessoires.**
- Si la plataforma está hecho con concreto, es necesario comprar el herraje de anclaje correcto. Recomendamos la utilización de un martillo perforador, broca de albañilería de ≈8 mm (5/16 in), ocho (8) tornillos de anclaje para concreto de ≈10 mm x 5 cm (3/8 in x 2 in) y ocho (8) rondanas de protección de ≈10 mm x 2,5 cm (3/8 in x 1 in). **No exceder un diámetro de ≈10 mm (3/8 in). Referirse a la ferretería local para obtener este herraje.**

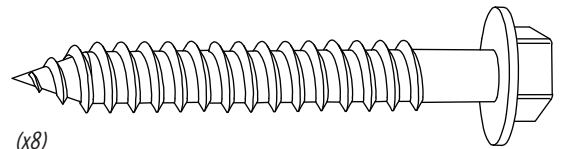
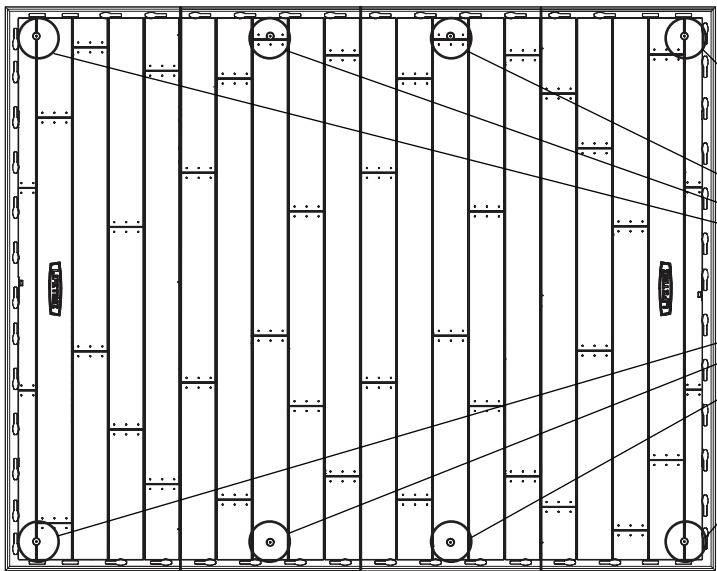

(x8)
(Not included) (Pas incluses) (No incluidos)

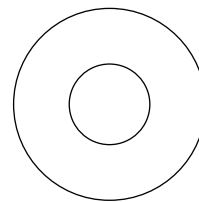

(x8)
(Not included) (Pas incluses) (No incluidos)



WARNING / AVERTISSEMENT / ADVERTENCIA



- Failure to anchor the shed may result in property damage and/or personal injury.
- Si vous n'ancrez pas votre abri, des dommages à la propriété et/ou des blessures peuvent en résulter.
- No anclar la caseta puede resultar en daños a la propiedad y/o en lesiones personales.

▶ SECTION 14 (CONTINUED) / SECTION 14 (SUITE) / SECCIÓN 14 (CONTINUACIÓN)

FOR A WOOD PLATFORM / PARA UNA PLATAFORMA DE MADERA / POUR UNE PLATE-FORME EN BOIS



5/16 in/po
(≈8 mm)



7/16 in/po
(≈11 mm)

ANCHORING TO A WOOD PLATFORM L'ANCRAGE DE L'ABRI À UNE PLATE-FORME EN BOIS EL ANCLAJE DE LA CASETA A UNA PLATAFORMA DE MADERA

14.1

- If you plan on anchoring your shed to a wood platform, you must purchase the correct anchoring hardware. We recommend using a drill, 5/16" (≈8 mm) drill bit, eight (8) 3/8" x 1 1/2" (≈10 mm x 4 cm) lag screws and eight (8) 3/8" x 1" (≈10 mm x 2,5 cm) fender washers. **Do not exceed a 3/8" (≈10 mm) diameter screw. Refer to your local hardware store for this hardware.**
- Si la plate-forme est faite de bois, il faut acheter la quincaillerie d'ancrage correcte. Nous recommandons d'utiliser une perceuse électrique, une mèche de ≈8 mm (5/16 po), huit (8) vis de retard de 10 mm x 4 cm (3/8 x 1 1/2 po), et huit (8) rondelles de protection de ≈10 mm x 2,5 cm (3/8 x 1 po). **Ne pas dépasser un diamètre de ≈10 mm (3/8 po). La quincaillerie du coin aura ces accessoires.**
- Si la plataforma está hecho con madera, es necesario comprar el herraje de anclaje correcto. Recomendamos la utilización de un taladro eléctrico, una broca de ≈8 mm (5/16 in), ocho (8) tornillos para madera de ≈10 mm x 4 cm (3/8 in x 1 1/2 in) y ocho (8) rondanas de protección de ≈10 mm x 2,5 cm (3/8 in x 1 in). **No exceder un diámetro de ≈10 mm (3/8 in). Referirse a su ferretería local para obtener este herraje.**

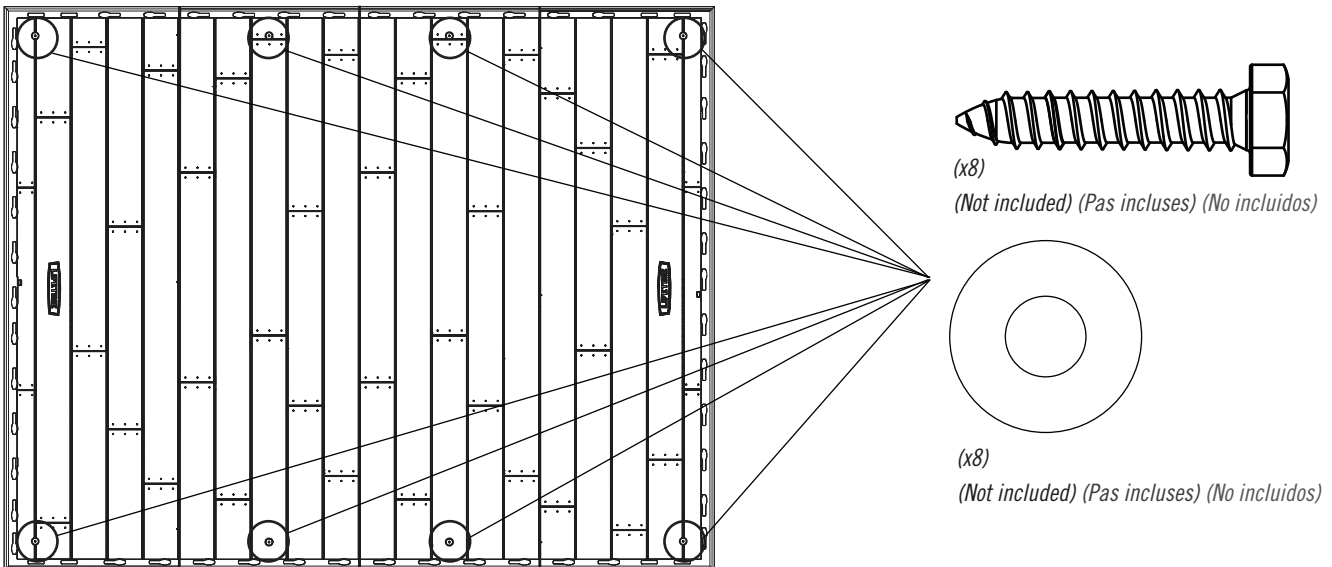

⚠ WARNING / AVERTISSEMENT / ADVERTENCIA ⚠

- Failure to anchor the shed may result in property damage and/or personal injury.
- Si vous n'ancrez pas votre abri, des dommages à la propriété et/ou des blessures peuvent en résulter.
- No anclar la caseta puede resultar en daños a la propiedad y/o en lesiones personales.

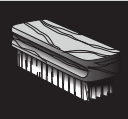

CLEANING & CARE

Congratulations on your Lifetime® product purchase. By following the instructions below, your new Lifetime product should provide you with years of service and enjoyment.

The polyethylene panels are stain and solvent resistant. Most stains can be removed using a mild soap and a soft-bristled brush. Abrasive cleaning materials may scratch the plastic and are not recommended. Repair scratches or rust spots on the metal by sanding the affected area lightly; using a rust preventative spray primer; and finally, spraying with a high-gloss spray enamel paint. Avoid placing a direct heat source on or near surfaces unless using a heat barrier.

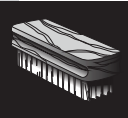

NETTOYAGE ET ENTRETIEN

Nous vous félicitons d'avoir acheté ce produit Lifetime®. En suivant les instructions ci-dessous, votre nouveau produit Lifetime devrait vous fournir des années de service et de plaisir.

Les murs et les étagères en polyéthylène sont résistants aux taches et solvants de nettoyage. Pour les nettoyer, se servir d'un savon doux et d'une brosse douce. Les produits abrasifs de nettoyage risquent d'égratigner le plastique et ne sont pas recommandés. Pour réparer les égratignures ou taches de rouille sur le métal, frotter légèrement l'endroit affecté au papier de verre, puis passer une couche de produit vaporisant préventif, et, enfin, vaporiser une peinture émail ultrabrillante. Éviter de placer une source de chaleur directe sur ou près des surfaces, ou les protéger à l'aide d'une protection contre la chaleur.



LIMPIEZA Y CUIDADO

Felicidades por la compra de su producto Lifetime®. Al seguir las siguientes instrucciones, su nuevo producto Lifetime le brindará años de servicio y satisfacción.

Los paneles de polietileno son resistentes a las manchas y solventes. La mayoría de las manchas puede removerse usando un jabón suave y un cepillo de cerdas suaves. Los materiales abrasivos para limpieza pueden rayar el plástico y no se recomiendan. Reparar rayones o manchas de óxido en el metal, lijando suavemente la parte afectada; usando un aerosol preventivo de óxido y finalmente, rociando con una pintura de esmalte brillante. Evitar poner una fuente de calor directa en o cerca de las superficies sin usar una barrera de calor.



REGISTER YOUR PRODUCT ONLINE AT WWW.LIFETIME.COM

At Lifetime®, we are committed to providing innovative and quality products. While registering, you will have the opportunity to give us your feedback. Your input is valuable to us.

- You can also opt in to receive new product notifications or promotions.
- In the unlikely event of a product recall or safety modification, your registration provides the information we need to notify you directly.
- Registration is fast, easy, and completely voluntary.

LIFETIME'S PROMISE TO YOU:

Maintaining your privacy is our long-standing policy at Lifetime®. And you can rest assured that Lifetime® will not sell or provide your personal data to other third parties, or allow them to use your personal data for their own purposes.

We invite you to read our privacy policy at www.lifetime.com

REGISTER today!



ENREGISTRER CE PRODUIT EN LIGNE À WWW.LIFETIME.COM

Chez Lifetime®, nous nous engageons à fournir des produits innovateurs de qualité. Lors de votre inscription, vous aurez l'occasion de nous faire parvenir vos commentaires. Votre opinion est importante pour nous.

- On peut également choisir de recevoir des avis ou des promotions dans le cadre de nouveaux produits.
- Dans l'éventualité improbable d'un rappel ou d'un avis de sécurité, l'inscription fournit les renseignements nécessaires nous permettant de communiquer avec vous.
- L'inscription est rapide, facile et complètement volontaire.

LA PROMESSE DE LIFETIME :

Conserver votre confidentialité est notre politique de longue date chez Lifetime®. Vous pouvez donc être rassuré par le fait que Lifetime® ne vendra pas ou ne fournira pas vos données personnelles à des tiers, et ne leur permettra pas d'utiliser vos données personnelles à leurs propres fins.

Nous vous invitons à lire notre politique de confidentialité à www.lifetime.com (en anglais seulement)

ENREGISTRER CE PRODUIT aujourd'hui!



REGISTRAR EL PRODUCTO EN LÍNEA EN WWW.LIFETIME.COM

En Lifetime®, estamos comprometidos a ofrecer productos innovadores y de calidad. Al registrarse, usted tendrá la oportunidad de darnos su retroalimentación. Su información es valiosa para nosotros.

- También puede optar por recibir nuestras notificaciones o promociones.
- En el caso improbable de que el producto deba ser retirado del mercado o que sufra alguna modificación, su registro provee la información que necesitamos para notificarle directamente.
- El registro es rápido, fácil y completamente voluntario.

LA PROMESA DE LIFETIME® PARA USTED:

Mantener privacidad es nuestra política permanente en Lifetime®. Y puede estar seguro que Lifetime® no venderá ni dará datos personales a terceros, ni les permitirá usar datos personales para sus propios fines.

Lo invitamos a leer nuestra política de privacidad en www.lifetime.com (sólo en inglés)

¡REGISTRARSE hoy mismo!



10-YEAR LIMITED FACTORY WARRANTY

THE MANUFACTURER RESERVES THE RIGHT TO MAKE SUBSTITUTIONS TO WARRANTY CLAIMS IF PARTS ARE UNAVAILABLE OR OBSOLETE.

1. Lifetime outdoor sheds are warranted to the original purchaser to be free from defects in material or workmanship for a period of ten years from the date of original retail purchase. The word “defects” is defined as imperfections that impair the use of the product. Defects resulting from misuse, abuse or negligence will void this warranty. This warranty does not cover defects due to improper installation, alteration or accident. This warranty does not cover damage caused by vandalism, rusting, “acts of nature” or any other event beyond the control of the manufacturer.
2. This warranty is nontransferable and is expressly limited to the repair or replacement of defective product. If the product is defective within the terms of this warranty, Lifetime Products, Inc. will repair or replace defective parts at no cost to the purchaser. Shipping charges to and from the factory or distribution center are not covered and are the responsibility of the purchaser. Labor charges and related expenses for removal, installation or replacement of the shed or its components are not covered under this warranty.
3. This warranty does not cover scratching or scuffing of the product that may result from normal usage. In addition, defects resulting from intentional damage, negligence, unreasonable use or hanging from the truss will void this warranty.
4. Liability for incidental or consequential damages is excluded to the extent permitted by law. While every attempt is made to embody the highest degree of safety in all equipment, freedom from injury cannot be guaranteed. The user assumes all risk of injury resulting from the use of this product. All merchandise is sold on this condition, and no representative of the company may waive or change this policy.
5. This product is not intended for institutional or commercial use; Lifetime Products, Inc. does not assume any liability for such use. Institutional or commercial use will void the warranty.
6. Our goods come with guarantees that cannot be excluded under the Australian Consumer Law. You are entitled to a replacement or refund for a major failure and for compensation for any other reasonably foreseeable loss or damage. You are also entitled to have the goods repaired or replaced if the goods fail to be of acceptable quality and the failure does not amount to a major failure.
7. This warranty is expressly in lieu of all other warranties, expressed or implied, including warranties of merchantability or fitness for use to extent permitted by Federal and state law. Neither Lifetime Products, Inc., nor any representative assumes any other liability in connection with this product. This warranty gives you specific legal rights, and you may also have other rights which vary from state to state (or province to province, as applicable in Canada).

PLEASE INCLUDE YOUR DATED SALES RECEIPT AND PHOTOGRAPHS OF DAMAGED PARTS.

REPORT PRODUCT DEFECTS IN WRITING TO:

Lifetime Products, Inc., PO Box 160010 Clearfield, UT 84016-0010
or call 1-800-225-3865 M-F 7 a.m. to 5 p.m. MST.

REGISTER YOUR PRODUCT FOR QUICKER CUSTOMER SERVICE.

Visit www.lifetime.com or call 1-800-225-3865 to register your product today.

FOR INTERNATIONAL WARRANTY CLAIMS:

All warranty claims must be accompanied by a sales receipt. Report all warranty claims in writing to your regional sales support representative. Please include your dated sales receipt and photographs of damaged parts.

To identify the representative for your region, please visit: www.lifetime.com/international



www.lifetime.com



GARANTIE DE FABRICATION LIMITÉE DE 10 ANS

LE FABRICANT SE RÉSERVE LE DROIT DE FAIRE DES SUBSTITUTIONS EN CAS DE RECOURS EN GARANTIE SI LES PIÈCES NE SONT PAS DISPONIBLES OU SONT OBSOLÈTES.

1. Les abris extérieurs Lifetime® sont garantis à l'acheteur d'origine contre tous défauts de matériau ou de fabrication pendant une durée de dix (10) ans à partir de la date d'achat d'origine. Le mot « défauts » signifie des défauts qui empêchent l'utilisation du produit. Les défauts résultant de mauvais usage, d'abus ou de négligence annulent cette garantie. Cette garantie ne couvre pas les dommages causés par le vandalisme, la rouille, « les catastrophes naturelles » ou tout autre événement en dehors du contrôle du fabricant.
2. Cette garantie n'est pas transférable et est expressément limitée à la réparation ou au remplacement du produit défectueux. Si le produit est déclaré défectueux selon les termes de cette garantie, Lifetime® Products, Inc. réparera ou remplacera les parties défectueuses gratuitement pour l'acheteur. Les frais d'expédition aller et retour de l'usine ne sont pas couverts et sont à la charge de l'acheteur. Les frais de main-d'œuvre et frais associés à l'enlèvement, au montage ou au remplacement de l'abri ou de ses composants ne sont pas couverts par cette garantie.
3. Cette garantie ne couvre pas les égratignures ou éraflures du produit résultant d'une utilisation normale. Par ailleurs, les défauts résultant de dommages intentionnels, négligence, utilisation abusive ou suspension à partir de l'entretoise annulent cette garantie.
4. Toute responsabilité pour dommages incidents ou consécutifs est exclue dans la mesure permise par la loi. Bien que toutes les mesures aient été prises pour intégrer le plus haut degré de sécurité dans l'ensemble du matériel, l'impossibilité de blessure ne peut pas être garantie. L'utilisateur assume tous les risques de blessure résultant de l'utilisation de ce produit. L'ensemble de la marchandise est vendu en vertu de cette condition et aucune personne représentant la société ne peut déroger à cette politique, ni la modifier.
5. Ce produit n'est pas prévu pour l'usage institutionnel ou commercial; Lifetime® Products, Inc. n'assume aucune responsabilité pour un tel usage. L'utilisation institutionnelle ou commerciale annulera cette garantie.
6. Nos articles sont offerts avec des garanties qui ne peuvent connaître d'exclusions en vertu de la loi australienne sur la protection des consommateurs. Vous avez droit au remplacement ou au remboursement en cas de défaillance majeure de votre article ainsi qu'à une compensation en cas de perte ou de dommage prévisible. Vous avez aussi droit à la réparation ou au remplacement de l'article s'il n'est pas d'une qualité acceptable et que la défaillance n'est pas majeure.
7. Cette garantie remplace expressément toutes les autres garanties, expresses ou tacites, y compris les garanties de commercialisation ou d'adaptation à un but particulier dans la mesure permise par les lois fédérales et des états. Ni Lifetime® Products, Inc. ni aucun de ses représentants n'assume d'autre responsabilité concernant ce produit. Cette garantie vous accorde des droits particuliers, et vous aurez peut-être d'autres droits qui varient d'un état à l'autre (ou d'une province à l'autre, selon le cas au Canada).

TOUS LES RECOURS EN GARANTIE DOIVENT ÊTRE ACCOMPAGNÉS DU REÇU DE VENTE.

FAIRE PARVENIR PAR ÉCRIT UN RAPPORT PAR ÉCRIT DE DÉFECTUOSITÉ DU PRODUIT À :

Lifetime Products, Inc., PO Box 160010 Clearfield, UT 84016-0010

ou composer 1-800-225-3865 lundi à vendredi 7 h – 17 h (HNR)

ENREGISTRER VOTRE ARTICLE À :

www.lifetime.com, ou composer 1-800-225-3865 pour enregistrer votre article aujourd'hui.

POUR RECOURS EN GARANTIE INTERNATIONAUX :

Tous les recours en garantie doivent être accompagnés du reçu de vente. Faire parvenir par écrit un rapport par écrit de défaut du produit au représentant régional de ventes. Veiller inclure votre reçu de vente daté et les photographies des pièces endommagées. Pour identifier le représentant régional, visiter www.lifetime.com/international



www.lifetime.com



GARANTÍA DE FÁBRICA LIMITADA POR 10 AÑOS

EL FABRICANTE SE RESERVA EL DERECHO DE HACER SUSTITUCIONES EN LOS ELEMENTOS REEMPLAZADOS BAJO GARANTÍA SI LAS PIEZAS NO ESTÁN DISPONIBLES O SON OBSOLETAS.

1. El comprador original recibe la garantía de que las casetas Lifetime estarán libres de defectos de material o de mano de obra por un período de 10 años a contar desde la fecha de la compra original. La palabra “defectos” se define como imperfecciones que perjudican el uso del producto. Los defectos emergentes de un mal uso, abuso o negligencia invalidarán esta garantía. Esta garantía no cubre defectos debidos a una instalación o alteración incorrecta o a un accidente. Esta garantía no cubre daños causados por vandalismo, oxidación, “actos de la naturaleza” u otros eventos que estén más allá del control del fabricante.
2. Esta garantía es intransferible, y queda expresamente limitada a la reparación o reemplazo de los productos defectuosos. Si el producto se encuentra defectuoso dentro de los términos de esta garantía, Lifetime Products, Inc. reparará o reemplazará las piezas defectuosas sin costo alguno para el comprador. Los gastos de envío hacia y desde la fábrica no están cubiertos, y quedan bajo la responsabilidad del comprador.
3. Esta garantía no cubre raspaduras ni marcas en el producto que pueden resultar de su uso normal. Además, los defectos causados por daños intencionales, negligencia, uso irrazonable o por colgarse de las cabriadas invalidarán esta garantía.
4. La responsabilidad por daños incidentales o consecuentes queda excluida hasta el punto en que lo permita la ley. Si bien se hace el mayor esfuerzo posible para lograr el más alto grado de seguridad en todos nuestros equipos, no puede garantizarse la libertad de cualquier tipo de lesión. El usuario asume todos los riesgos de lesiones emergentes del uso de este producto. Toda nuestra mercadería se vende bajo esta condición, y ningún representante de la compañía puede anular ni cambiar esta política.
5. Este producto no está pensado para el uso institucional ni comercial; Lifetime Products, Inc. no asume ninguna otra responsabilidad en conexión con este producto. El uso institucional o comercial invalidará la garantía.
6. Nuestros productos vienen con garantías que no se pueden excluir bajo la Ley del consumidor de Australia. Ustedes están autorizados para reemplazarlos u otorgar una devolución o reembolso en caso de falla mayor y en compensación por cualquier otra falla o daño previsible. También, están autorizados para hacer reparar los productos o reemplazarlos si éstos no cumplen con una calidad aceptable y si la falla no es motivo de una deficiencia mayor.
7. Esta garantía se otorga en reemplazo expreso de toda otra garantía, expresa o implícita, incluidas las garantías de comercialización o adaptación para el uso en la medida permitida por las leyes federales y estatales. Ni Lifetime Products, Inc., ni ninguno de sus representantes asume ninguna otra responsabilidad en conexión con este producto. Esta garantía le otorga derechos legales específicos, y usted puede tener otros derechos que varían de estado a estado (o de una provincia a otra, según corresponda en Canadá).

NINGUNA GARANTÍA OFRECIDA POR EL FABRICANTE ES VÁLIDA EN MÉXICO

TODOS LOS RECLAMOS DE GARANTÍA DEBEN ESTAR ACOMPAÑADOS POR UN RECIBO DE COMPRA

INFORME POR ESCRITO LOS DEFECTOS EN EL PRODUCTO A:

Por favor, incluir el recibo de compra fechado y fotografías de las piezas dañadas.

Lifetime Products, Inc., PO Box 160010 Clearfield, UT 84016-0010,

o marcar al 1.800.225.3865 de lunes a viernes de 0700 hasta 1700 (Hora de las Montañas)

REGISTRAR SU PRODUCTO

Visitar nuestra página en Internet www.lifetime.com, o marcar al 1.800.225.3865 para registrar el producto hoy.

PARA RECLAMOS DE GARANTÍA INTERNACIONALES:

Todos los reclamos de garantía deben estar acompañados por un recibo de compra. Informar por escrito todos los reclamos de garantía a su representante regional de ventas. Favor de incluir el recibo de compra fechado y fotografías de las piezas dañadas.

Para identificar el representante regional, visitar www.lifetime.com/international



www.lifetime.com

ENHANCE YOUR LIFETIME® PURCHASE BY ADDING ACCESSORIES OR OTHER GREAT PRODUCTS

To purchase accessories or other Lifetime® products, visit us at:

www.lifetime.com

Or call: 1-800-424-3865

7:00 am–5:00 pm (M–F) MST and 9:00 am–1:00 pm Saturday MST

AMÉLIORER L'ACHAT LIFETIME® EN AJOUTANT DES ACCESSOIRES OU D'AUTRES PRODUITS

Pour acheter des accessoires ou des autres produits Lifetime®, visiter le :

www.lifetime.com

Ou composer le 1-800-424-3865

Du lundi au vendredi de 7 h à 17 h, HR et le samedi de 9 h à 13 h, HR

MEJORAR LA COMPRA DE LIFETIME® AGREGANDO ACCESORIOS U OTROS MARAVILLOSOS PRODUCTOS

Para comprar accesorios u otros productos de Lifetime®, visitarnos en:

www.lifetime.com

O marcar al: 1-800-424-3865

De lunes hasta viernes 7:00 hr–17:00 hr Horario Éstandar de la Montaña (MST) y sábados 9:00 hr–13:00 hr (MST)



www.lifetime.com

