

PARTS

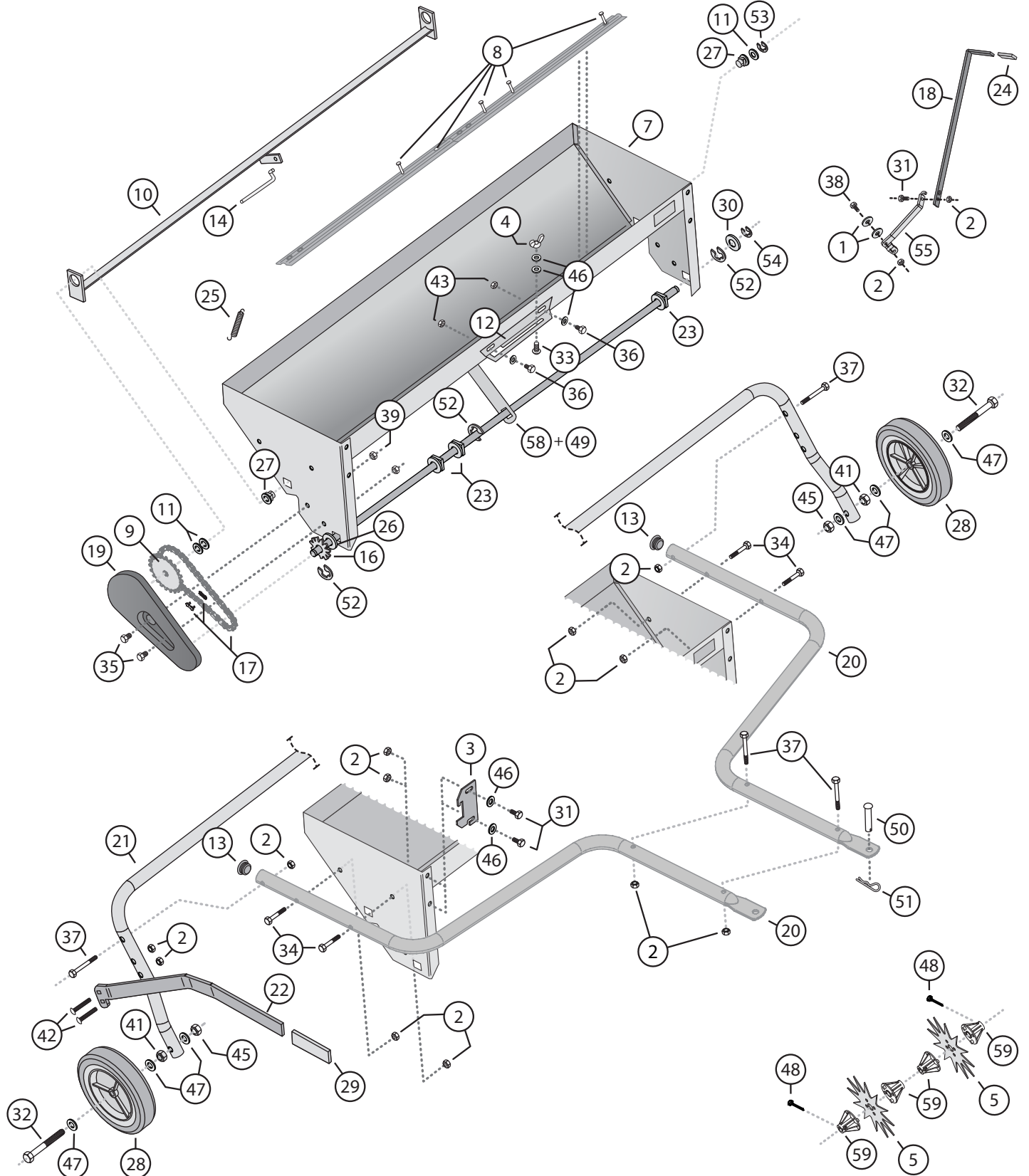

PARTS

AS2-40BH1-S

Ref #	Part #	Description	Qty
1	R-774	Flat Washer - Large	2
2	B-1674P	5/16" Hex Lock Nut	1
4	B-4030	1/4" Wing Nut	1
5	1018833	Aerator Tine	11
7	1019427	Hopper Assembly	1
8	1019249	Agitator Kit (Hwd. Incl.)	2
9	1019153-06	Agitator Shaft Assembly	1
10	B-5726-06	Shutter Assembly	1
11	B-4713	1/2" Washer	3
12	B-4715Y	Calibration Plate	1
14	1019154-01	Shutter Link	1
16	1019147	Tine Shaft Assembly	1
17	1019144	Drive Chain and Offset Link	1
18	1019150-06	Upper Lever	1
19	B-4726	Chain Shield	1
20	B-6410-06	Tow Bar	2
21	1018838-06	Wheel Support Assembly	1
22	B-6413-06	Lift Handle	1
23	1019145	Square Bearing (Large)	3
25	B-4747	Tension Spring	1
26	B-4768	5/8" (Thin) Washer	3
27	1019148	1/2" Square Bearing (Small)	2
28	B-6526	Wheel	2
30	B-5456	5/8" (Thick) Washer	3
33	11M0808P	Carriage Bolt, 1/4" x 1/2"	1
35	2M0808P	Hex Bolt, 1/4" x 1/2"	2
36	2M1008P	Hex Bolt 5/16" x 1/2"	2
38	2M1016P	Hex Bolt 5/16" x 1"	1
39	B-4785	Lock Nut, 1/4"	2
43	B-4786	Lock Nut, 5/16"	2
46	45M1111P	Flat Washer, 5/16"	4

Ref #	Part #	Description	Qty
48	50M0524P	Cotter Pin, 5/32 x 1-1/2"	2
49	V-302P	Pop Rivet, 3/16" x .277	4
52	B-4307	"E" Ring, 1"	3
53	F-621	"E" Ring, 1/2"	1
54	F-577	"E" Ring, 5/8"	1
55	1019149-06	Lower Lever	1
58	1019307-06	Center Strap	1
59	101958	Bearing	22

HARDWARE PACK - Used during assembly:

1018842	SKIN PACK	1	
2	B-1674P	5/16" Hex Lock Nut	13
3	B-6520	Transport Lock	1
13	B-6484	Cap, Tub	2
24	1018845	Vinyl Grip (1/8" x 3/4")	1
29	1018844	Handle Grip (5/16" x 1-1/4")	1
31	2M1012P	Hex Bolt, 5/16" x 3/4"	3
32	B-6517	Hex Bolt, 1/2" x 3-1/2"	2
34	2M1032P	Hex Bolt, 5/16" x 2"	4
37	4M1048P	Hex Bolt, 5/16" x 3"	4
41	31M1600P	Hex Jam Nut, 1/2"	2
42	11M1028P	Carriage Bolt, 5/16" x 1-3/4"	2
45	B-5096Y	Nut, Nylon Lock, 1/2"	2
46	45M1111P	Flat Washer, 5/16"	2
47	1019753	Flat Washer, 1/2"	6
50	B-3861	Drawbar Pin	1
51	1019151	Hairpin Cotter	1

HARDWARE IDENTIFIER

Illustrations on this page are to scale for faster identification of hardware during assembly.

DO NOT RETURN PRODUCT IF YOU ARE MISSING PARTS.
Please Call: 1 (877) 728-8224

④⑥ Washer: Flat
5/16" (x2)
45M1111P

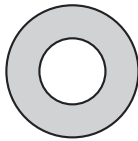

④⑦ Washer: Flat
1/2" (x6)
1019753

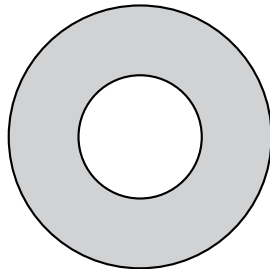

⑤① Hairpin Cotter (x1)
1019151

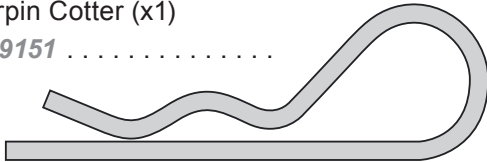

③② Bolt: Hex Head,
1/2" x 3 1/2" (x2)
B-6517

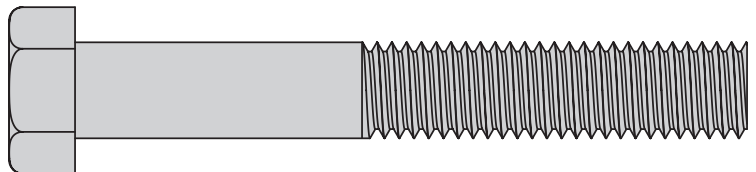

③④ Bolt: Hex Head 5/16 x 2" (x4)
2M1032P

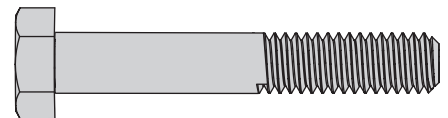

③⑦ Bolt: Hex Head 5/16 x 3" (x4)
4M1048P



④② Bolt: Carriage 5/16 x 1-3/4" (x2)
11M1028P

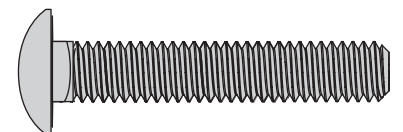

⑤① Drawbar Pin: 1/2" x 2 1/2" (x1)
B-3861

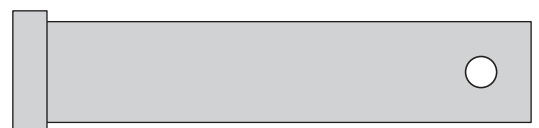

② Nut: Hex Head Locking
5/16" -18 (x13)
B-1674P

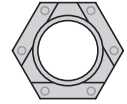

④① Nut: Hex Jam
1/2" (x2)
31M1600P

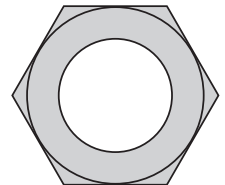

④⑤ Nut: Nylon Lock
1/2" (x2)
B-5096Y

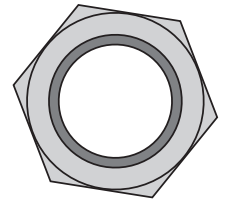

③① Bolt: Hex Head,
5/16 x 3/4" (x3)
2M1012P

