



INSTRUCTIONS D'ASSEMBLAGE
ASSEMBLY INSTRUCTIONS

MONARCH
SPECIALTIES INC.

I 1302

**TABLE A MANGER -
36"X 60" / ESPRESSO**

**DINING TABLE -
36"X 60" / ESPRESSO**



**POUR DE L'ASSISTANCE OU POUR COMMANDER
DES PIÈCES CONTACTEZ NOTRE DÉPARTEMENT
DE SERVICE À LA CLIENTÈLE.**

**FOR ASSISTANCE OR TO ORDER PARTS
CONTACT OUR CUSTOMER SERVICE DEPARTMENT**

WWW.MONARCHSERVICE.COM

LISTE DES PIÈCES
PARTS LIST

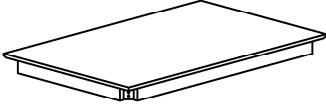
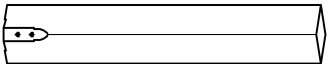
PIÈCE / PART #	IMAGE	DESCRIPTION	QTY / QTÉ
1	 A perspective drawing of a rectangular table top with a slightly beveled edge.	TABLE TOP SURFACE DE TABLE	1
2	 A perspective drawing of a cylindrical table leg with a decorative flange at the top and two small circular details on the side.	TABLE LEG PATTE DE TABLE	4

LISTE DES PIÈCES DE MONTAGE
HARDWARE LIST

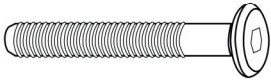
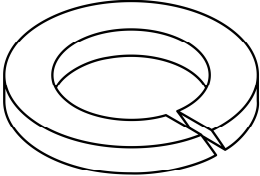
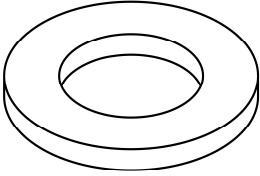
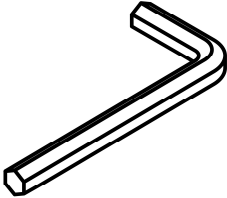
PIÈCE / PART #	IMAGE	DESCRIPTION	QTY / QTÉ
A		<p align="center">ASSEMBLING BOLT - Ø 3/8" X 2 3/8" BOULON D'ASSEMBLAGE - Ø 3/8" X 2 3/8"</p>	8
B		<p align="center">LOCK WASHER ENTRETOISE DE MÉTAL</p>	8
C		<p align="center">METAL WASHER RONDELLE DE MÉTAL</p>	8
D		<p align="center">HEX KEY CLÉ HEXAGONALE</p>	1



OUTIL DE VÉRIFICATION DE DIMENSIONS DES PIÈCES
HARDWARE DIMENSIONS VERIFICATION TOOL



ÉTAPE / STEP 1

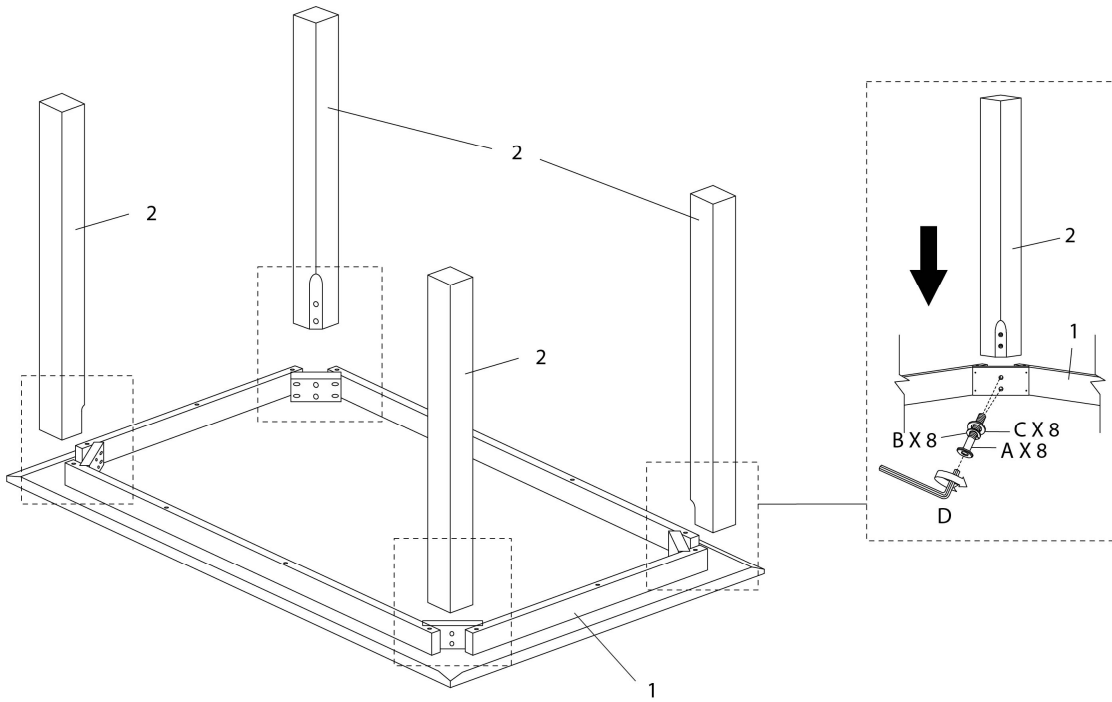

ÉTAPE / STEP 2

