



INSTRUCTIONS D'ASSEMBLAGE
ASSEMBLY INSTRUCTIONS

MONARCH
SPECIALTIES INC.

I 6035Q

LIT -
QUEEN / TISSUS GRIS / PATTES METAL CHROME

BED -
QUEEN SIZE / GREY LINEN WITH CHROME METAL
LEGS



POUR DE L'ASSISTANCE OU POUR COMMANDER
DES PIÈCES CONTACTEZ NOTRE DÉPARTEMENT
DE SERVICE À LA CLIENTÈLE.

FOR ASSISTANCE OR TO ORDER PARTS
CONTACT OUR CUSTOMER SERVICE DEPARTMENT

WWW.MONARCHSERVICE.COM

LISTE DES PIÈCES
PARTS LIST

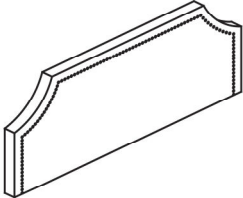
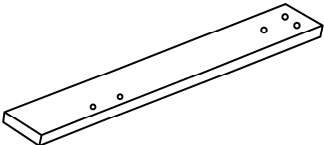
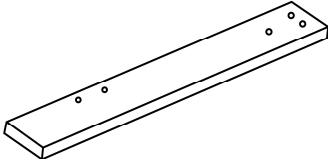
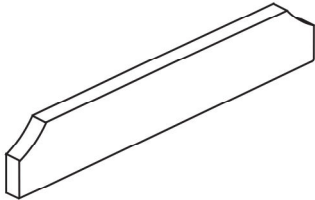
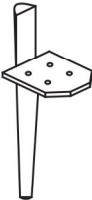
PIÈCE / PART #	IMAGE	DESCRIPTION	QTY / QTÉ
1		HEADBOARD TÊTE DE LIT	1
2		FRONT FACING HEADBOARD LEFT LEG TÊTE DE LIT AVANT GAUCHE	1
3		FRONT FACING HEADBOARD RIGHT LEG TÊTE DE LIT AVANT DROITE	1
4		FOOTBOARD PIED DE LIT	1
5		METAL LEG PATTE EN METAL	2

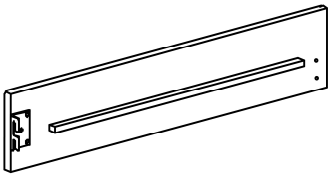
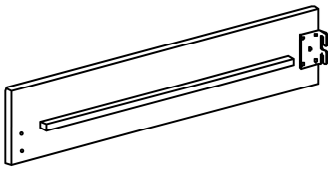
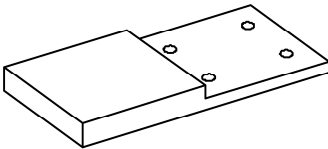
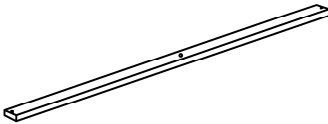
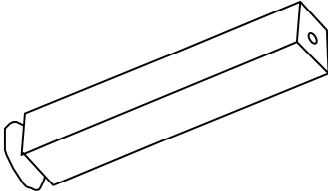

LISTE DES PIÈCES
PARTS LIST

PIÈCE / PART #	IMAGE	DESCRIPTION	QTY / QTÉ
6		SIDE RAIL RAIL DE CÔTÉ	2
7		SIDE RAIL RAIL DE CÔTÉ	2
8		SIDE RAIL SUPPORT LEG RAIL DE CÔTÉ PATTE DE SOUTIEN	2
9		SLAT LAMELLE	4
10		SUPPORT LEG PATTE DE SOUTIEN	4

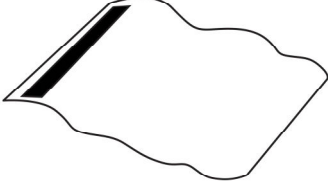
LISTE DES PIÈCES
PARTS LIST

PIÈCE / PART #	IMAGE	DESCRIPTION	QTY / QTÉ
11		LEG COVER COUVRE PATTE	2

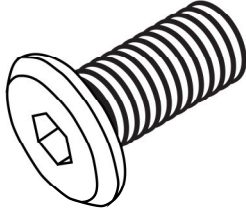
LISTE DES PIÈCES DE MONTAGE
HARDWARE LIST

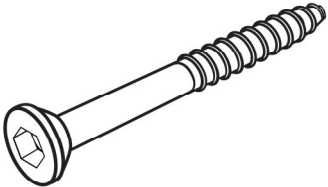
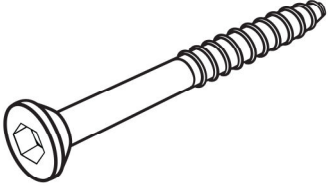
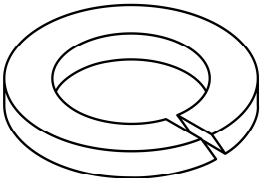
PIÈCE / PART #	IMAGE	DESCRIPTION	QTY / QTÉ
A		ASSEMBLING BOLT - Ø3/8" X 7/8" BOULON D'ASSEMBLAGE - Ø3/8" X 7/8"	8
B		ASSEMBLING BOLT - Ø1/4" X 7/8" BOULON D'ASSEMBLAGE - Ø1/4" X 7/8"	8
C		ASSEMBLING SCREW - Ø1/4" X 1 3/8" VIS D'ASSEMBLAGE - Ø1/4" X 1 3/8"	12
D		ASSEMBLING SCREW - Ø1/4" X 1 1/2" VIS D'ASSEMBLAGE - Ø1/4" X 1 1/2"	6
E		LOCK WASHER ENTRETOISE DE MÉTAL	14

LISTE DES PIÈCES DE MONTAGE
HARDWARE LIST

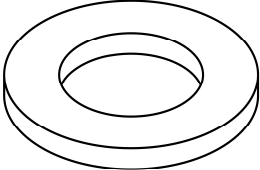
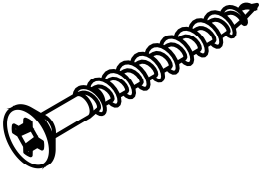
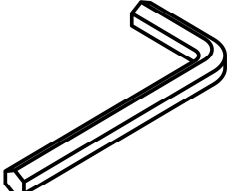
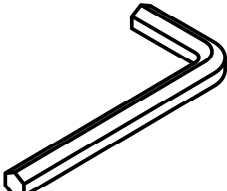
PIÈCE / PART #	IMAGE	DESCRIPTION	QTY / QTÉ
F		METAL WASHER RONDELLE DE MÉTAL	14
G		ASSEMBLING SCREW - Ø1/8" X 1 1/4" VIS D'ASSEMBLAGE - Ø1/8" X 1 1/4"	8
H		HEX KEY - M5 X 2 1/2" CLÉ HEXAGONALE - M5 X 2 1/2"	1
I		HEX KEY - M4 X 4" CLÉ HEXAGONALE - M4 X 4"	1

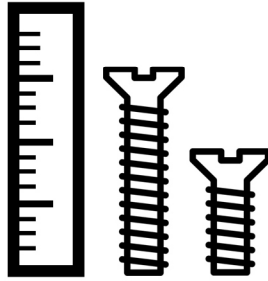

OUTIL DE VÉRIFICATION DE DIMENSIONS DES PIÈCES
HARDWARE DIMENSIONS VERIFICATION TOOL

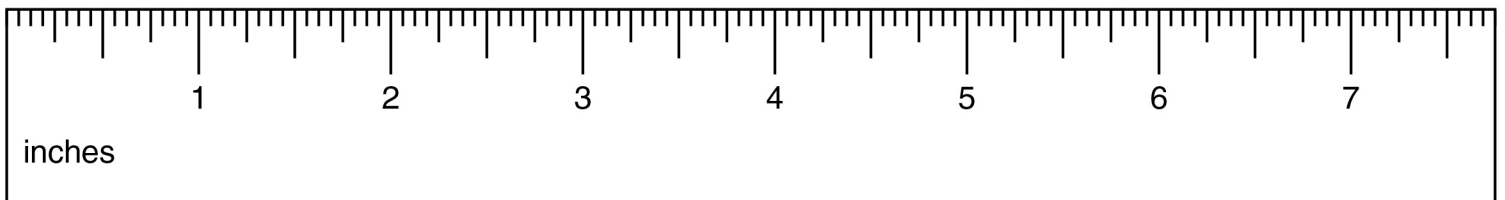

ÉTAPE / STEP 1

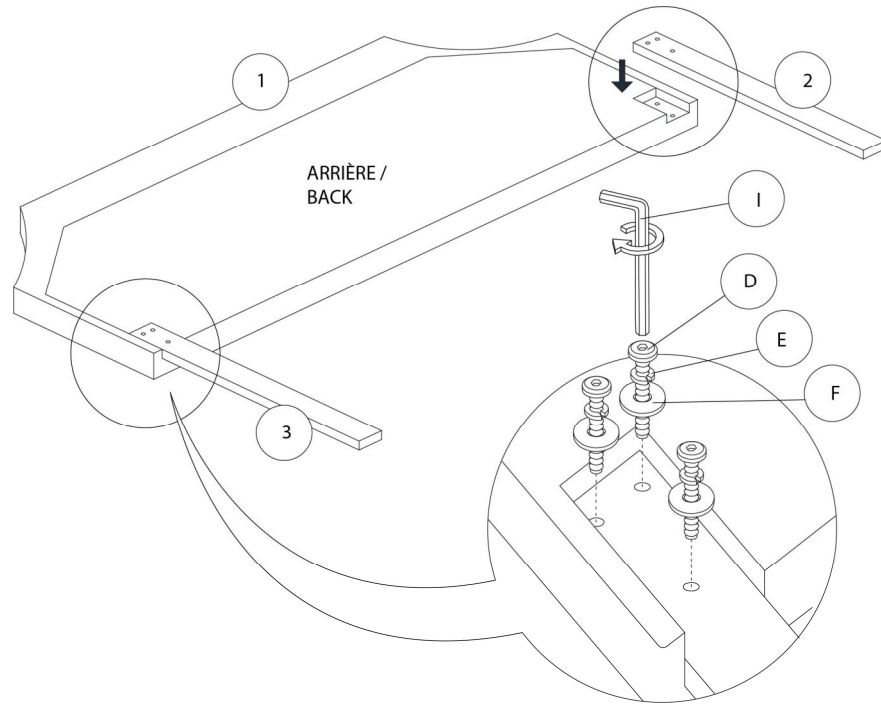

ÉTAPE / STEP 2

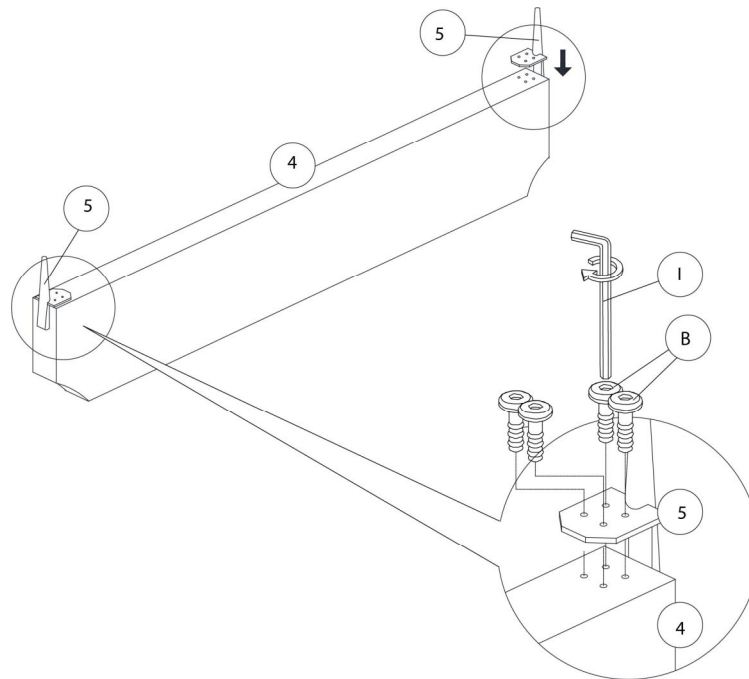

ÉTAPE / STEP 3

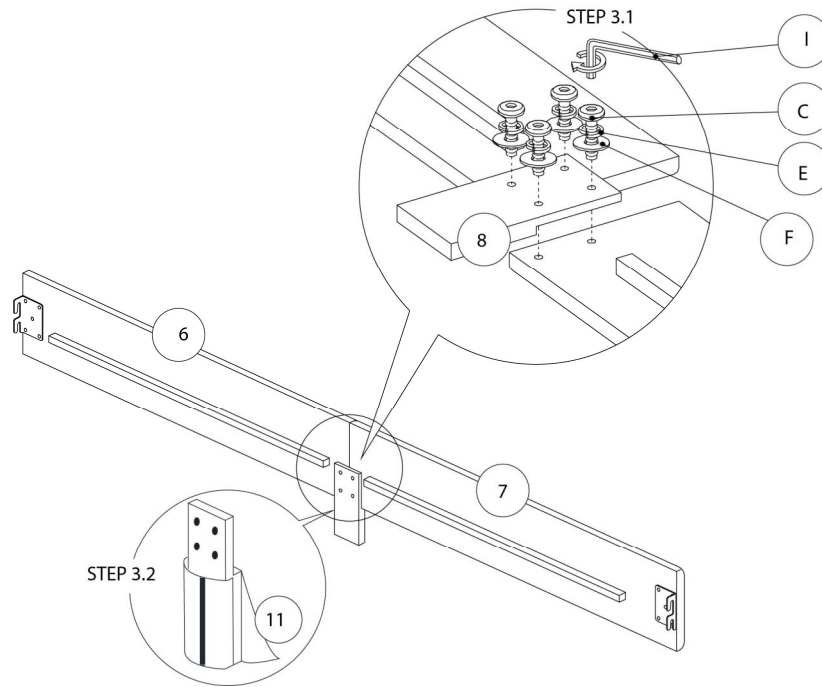

ÉTAPE / STEP 4

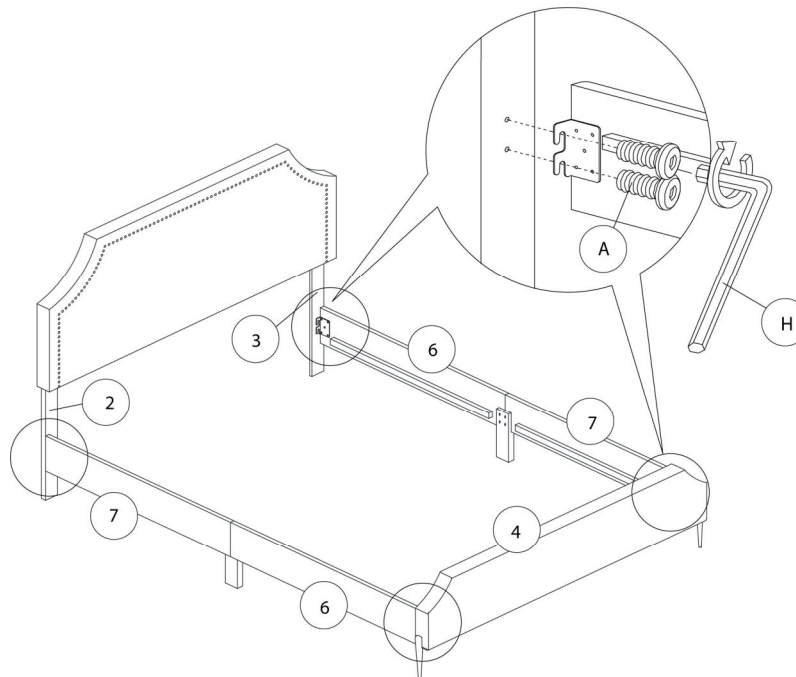

ÉTAPE / STEP 5

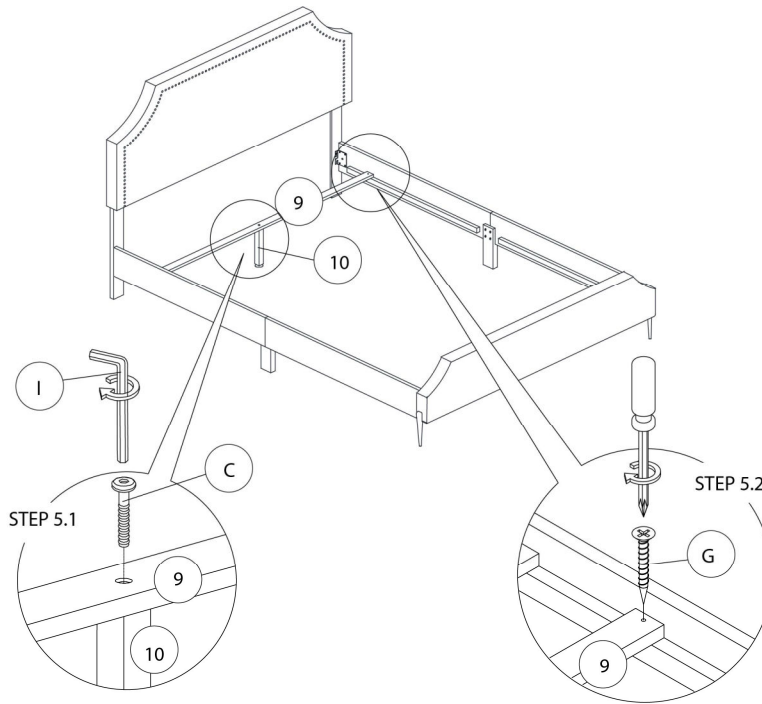

ÉTAPE / STEP 6

