



INSTRUCTIONS D'ASSEMBLAGE
ASSEMBLY INSTRUCTIONS

MONARCH
SPECIALTIES INC.

I 3468

TABLE D'APPOINT -
25"H / BLANC / METAL BLANC

ACCENT TABLE -
25"H / WHITE / WHITE METAL



POUR DE L'ASSISTANCE OU POUR COMMANDER
DES PIÈCES CONTACTEZ NOTRE DÉPARTEMENT
DE SERVICE À LA CLIENTÈLE.

FOR ASSISTANCE OR TO ORDER PARTS
CONTACT OUR CUSTOMER SERVICE DEPARTMENT

WWW.MONARCHSERVICE.COM

LISTE DES PIÈCES
PARTS LIST

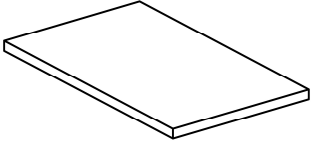
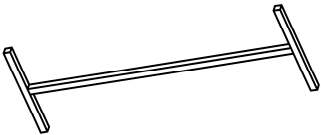
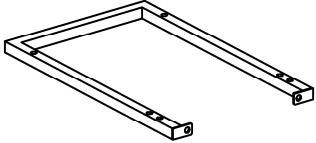
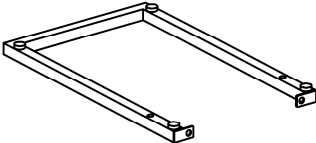
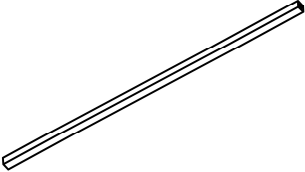
PIÈCE / PART #	IMAGE	DESCRIPTION	QTY / QTÉ
1		<p>TABLE TOP SURFACE DE TABLE</p>	1
2		<p>BACK FRAME CADRE DU DOSSIER</p>	1
3		<p>TOP FRAME CADRE DE SURFACE</p>	1
4		<p>BOTTOM FRAME CADRE DU BAS</p>	1
5		<p>SUPPORT BAR BARRE DE SOUTIEN</p>	2

LISTE DES PIÈCES DE MONTAGE
HARDWARE LIST

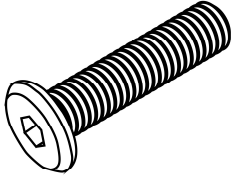
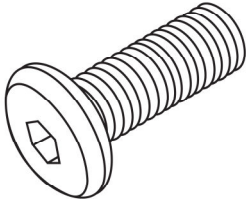
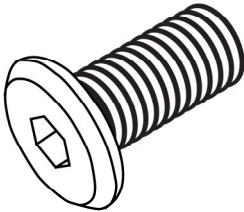
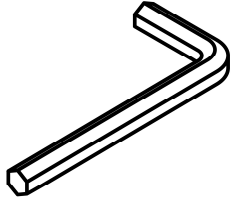
PIÈCE / PART #	IMAGE	DESCRIPTION	QTY / QTÉ
A		ASSEMBLING BOLT - Ø 1/4" X 1 1/8" BOULON D'ASSEMBLAGE - Ø 1/4" X 1 1/8"	4
B		ASSEMBLING SCREW - Ø 1/4" X 1" VIS D'ASSEMBLAGE - Ø 1/4" X 1"	4
C		ASSEMBLING BOLT - Ø 1/4" X 1/2" BOULON D'ASSEMBLAGE - Ø 1/4" X 1/2"	4
D		HEX KEY CLÉ HEXAGONALE	1



OUTIL DE VÉRIFICATION DE DIMENSIONS DES PIÈCES
HARDWARE DIMENSIONS VERIFICATION TOOL



ÉTAPE / STEP 1

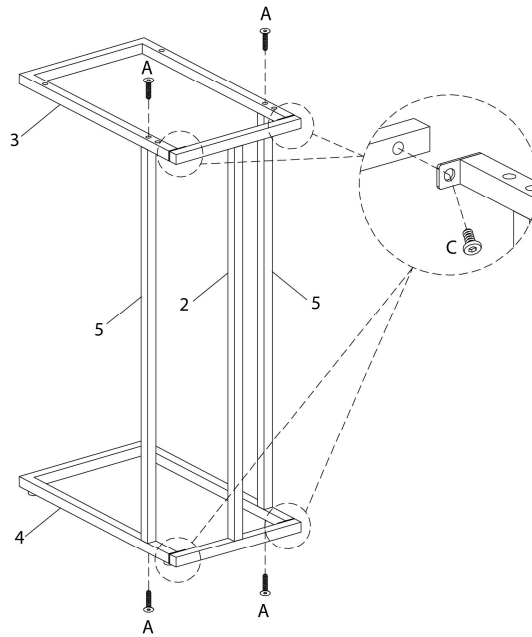

ÉTAPE / STEP 2

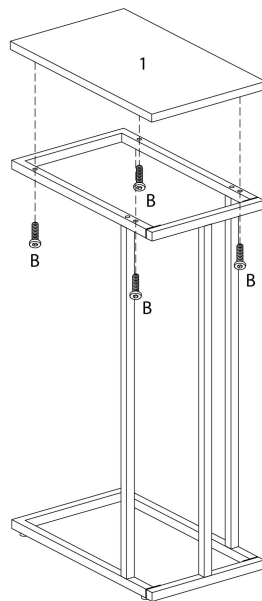

ÉTAPE / STEP 3

