

# Haunted Hill Farm®

Thank you for choosing Haunted Hill Farm!

Valuable feedback like yours helps us make our products even better and helps other potential customers on their shopping journey!

If you're fully satisfied, we would love for you to leave us a review where you purchased the product.



If you have any questions, concerns or suggestions, please contact us directly. Our team is here to help!



**boo@HauntedHillFarm.com** (Anytime)



**888-840-4559** (9AM to 5PM Eastern Time, M-F)

In the unlikely event that you experience a problem, please provide pictures and a description of the problem, a receipt (if available), name and address of the purchaser and the name of retailer where you purchased the product.

**Please do not return this item to the retailer.**

See the full Haunted Hill Farm collection and get online support for assembly, troubleshooting, care and maintenance at:

**[www.HauntedHillFarm.com](http://www.HauntedHillFarm.com)**

# Please follow the step by step guide and enjoy 84in Hunched Reaper

## HHHNCHRPR-1FLSA

The model number of your item is printed on the side of your carton.

Always use this number to identify your item.

Thank you for your purchase of this quality Halloween decor. With proper use and care, your Halloween decor will provide you with years of enjoyment. Please follow the instructions on how to assemble and disassemble your item. If you should have any problems with your item, or you have any questions, DO NOT return it to the place of purchase. Please call our toll-free number:

**1-888-840-4559** and a customer service representative will assist you. Enjoy your Holiday!



ALL NEW MATERIALS:  
METAL, FOAM, PLASTIC, POLYESTER  
**Surface washable only.**

## PARTS LIST

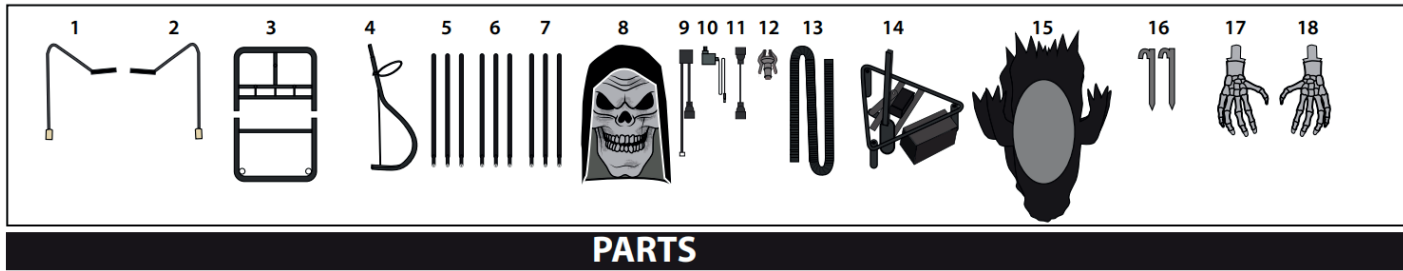

### PARTS

- |                      |                         |                      |                            |                |
|----------------------|-------------------------|----------------------|----------------------------|----------------|
| 1. RIGHT ARM         | 5. LOWER SUPPORT POLES  | 9. FOG CORD          | 13. FOG HOSE               | 17. RIGHT HAND |
| 2. LEFT ARM          | 6. MIDDLE SUPPORT POLES | 10. 6V 2A ADAPTER    | 14. WAIST AND CONTROL BOX  | 18. LEFT HAND  |
| 3. METAL STAND QTY 2 | 7. UPPER SUPPORT POLES  | 11. FOG CORD ADAPTER | 15. CLOAK AND PLASTIC BACK |                |
| 4. UPPER SPINE POLE  | 8. HEAD AND HOOD        | 12. FOG BRACKET      | 16. METAL STAKES           |                |

**BEFORE ASSEMBLING, REMOVE ALL THE ABOVE PARTS FROM BOX. IF ANY PART IS MISSING, DO NOT ATTEMPT TO ASSEMBLE THE PRODUCT. CONTACT CUSTOMER SERVICE AT [BOO@HAUNTEDHILLFARM.COM](mailto:BOO@HAUNTEDHILLFARM.COM), OR BY PHONE FROM 9:00AM TO 5:00PM EST AT 1-888-840-4559.**

### CARE AND STORAGE INSTRUCTIONS

When the product not in use, store in its original packing after it is completely dry.

Keep away from heat.

Please read all instructions carefully before assembling. Save this instruction sheet for future reference.

### WARNING

This item is not a toy and should be used for decoration only. This item contains small parts that can be a choking hazard. Keep all plastic and wire parts away from children. Recommended for ages 14 and up.

1. Please use the adapter supplied by manufacturer.

2. Please assemble item according to instructions. Connect all wires according to matching color.

3. Children should be supervised by adults. Item should not be grabbed, as it becomes a tipping hazard. Keep all away from the adapter, as it heats up during operation.

4. This item contains Polyvinyl Chloride (PVC).

5. Colors, style and contents may vary slightly from those shown on the package

## ASSEMBLY INSTRUCTIONS

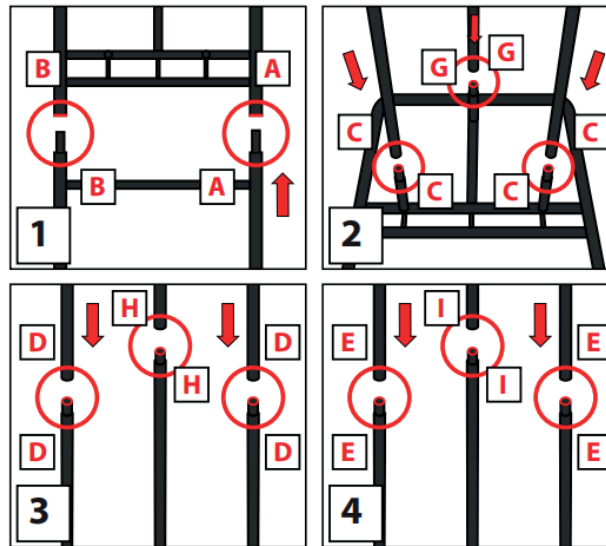

1. Snap lock both halves of the METAL STAND together. (Match A to A) and (Match B to B)
2. Snap Lock 3 LOWER SUPPORT POLES onto the assembled METAL STAND. (Match C to C) and (Match G to G)
3. Snap Lock 3 MIDDLE SUPPORT POLES onto the LOWER SUPPORT POLES. (Match D to D) and (Match H to H)
4. Snap Lock 3 UPPER SUPPORT POLES onto the MIDDLE SUPPORT POLES. (Match E to E) and (Match I to I)

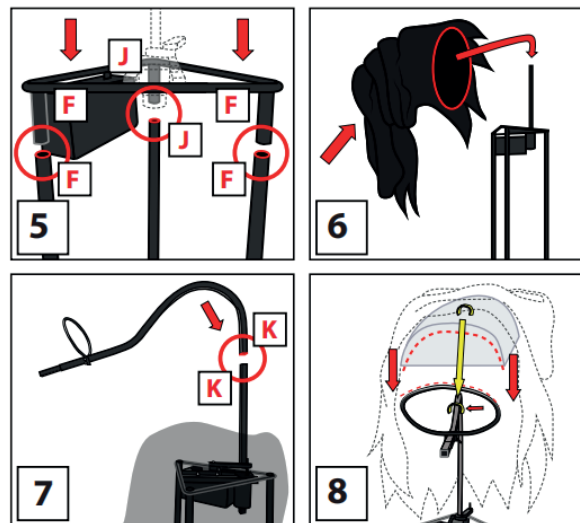

5. Snap lock the WAIST AND CONTROL BOX onto the UPPER SUPPORT POLES. (Match F to F) and (Match J to J)
6. Place the CLOAK AND PLASTIC BACK over the WAIST AND CONTROL BOX.
7. Snap Lock the UPPER SPINE POLE to the WAIST AND CONTROL BOX. (Match K to K)
8. Secure the CLOAK WITH PLASTIC BACK over the UPPER SPINE POLE with hook and loop fastener and seat the PLASTIC BACK onto the large metal ring.

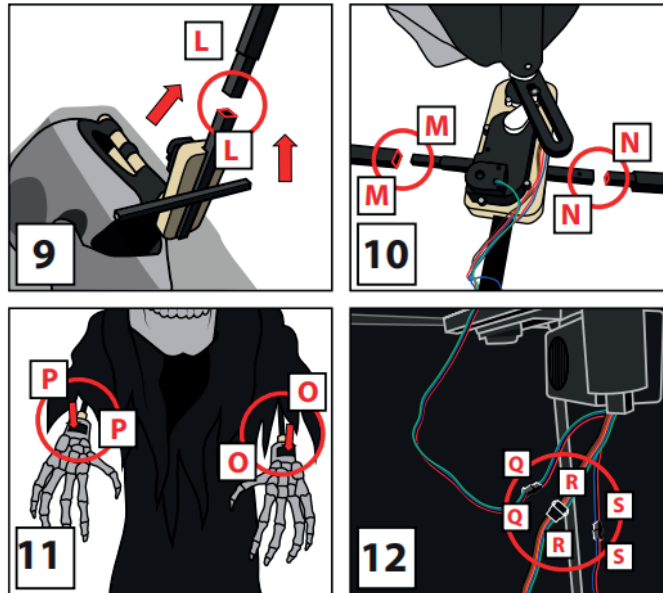

9. Snap lock the HEAD AND HOOD to the UPPER SPINE POLE. (Match L to L)
10. Insert the LEFT AND RIGHT ARMS through the sleeves of the CLOAK WITH PLASTIC BACK. Snap lock the LEFT AND RIGHT ARMS to the metal bracket behind the HEAD. (Connect M to M) and (Connect N to N)
11. Snap lock both HANDS to the ends of the LEFT AND RIGHT ARMS. (Match O to O) and (Match P to P) Secure the hook and loop fastener on each sleeve to the hook and loop fasteners located on the back of both hands.
12. Connect the wires located underneath the CLOAK AND PLASTIC BACK from the CONTROL BOX to the HEAD. (Connect Q to Q), (Connect R to R) and (Connect S to S)

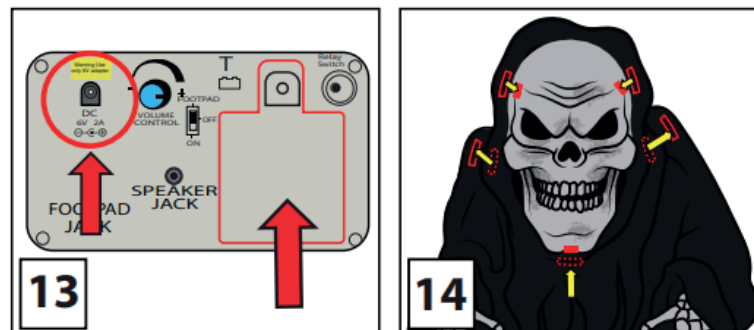

13. Reach inside the CLOAK AND PLASTIC BACK . Connect 6V 2A ADAPTER (included) or insert 4 AA alkaline batteries (not included) into the battery compartment located on the CONTROL BOX. Turn the switch to the ON position to activate the item. Move in front of the item to activate. Turn item OFF when not in use.  
**NOTE:** A PIR sensor detects the human infrared signature and must be uncovered and facing forward to trigger this item. In order for the FOGGING GRIM REAPER to function optimally, make sure the PIR sensor located on the front of the HEAD is not blocked or obstructed in any way.
14. Attach the 3 hook and loop fasteners located on the HOOD to the HEAD. Fasteners are located on the chin and sides of the HEAD. Attach the two hook and loop fasteners located on the hood to fasteners located on the CLOAK. Proceed to the FOG SET UP to continue assembly and operation.

# FOG MACHINE SETUP

Your FOG MACHINE (400 or 1000 watt) can be used in conjunction with THE FOGGING GRIM REAPER™.

FOG MACHINE IS NOT INCLUDED. MUST BE PURCHASED SEPARATELY.

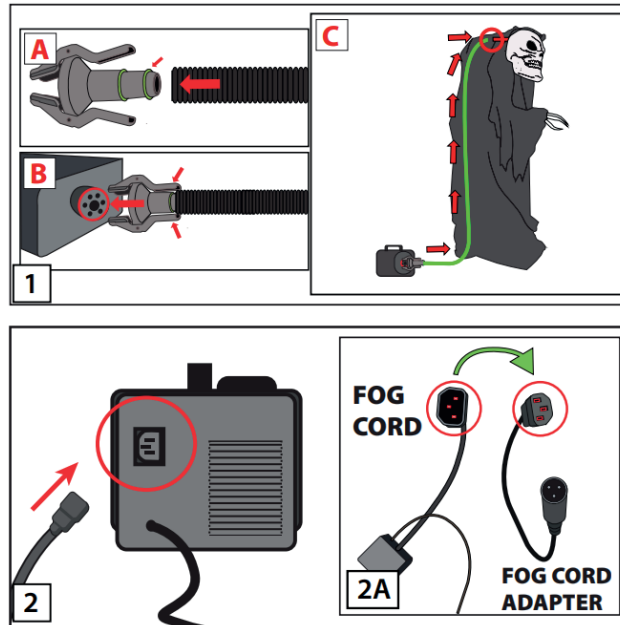

ONLY ATTACH A FOG MACHINE AS INSTRUCTED BELOW. \*\* MAKE SURE THE FOGGING GRIM REAPER™ IS SET TO THE “OFF” POSITION AND YOUR FOG MACHINE IS TURNED OFF\*\*

- 1A. Slide FOG TUBE over the FOG BRACKET as seen in illustration A. The fog hose will click in place over the raised surface of the FOG BRACKET. (see illustration A)
- 1B. Depress the lever arms of the FOG BRACKET and attach to the fog machine nozzle. (see illustration B)
- 1C. Run the FOG HOSE under the clothing and attach to the back of the HEAD. (see illustration C)
2. Plug the FOG CORD into your fog machine. If the fog cord plug does not fit, see illustration 2A.
  - 2A. Plug the FOG CORD into the FOG CORD ADAPTER. Plug the FOG CORD ADAPTER into your fog machine.

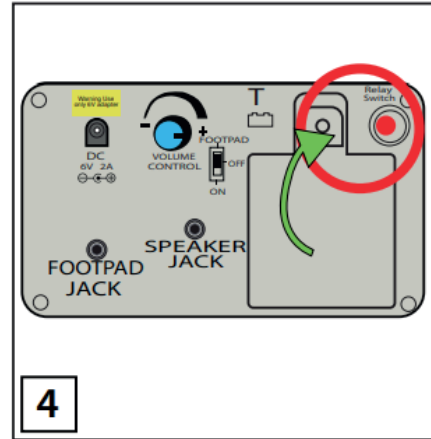
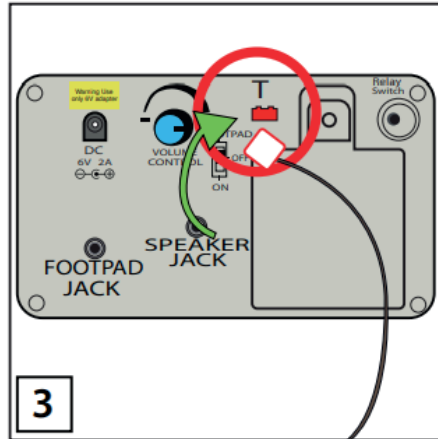

3. Plug the other end of the FOG CORD into the jack labeled T on the CONTROL BOX. (Match T to T)
4. Make sure your fog machine is heated up properly, turn your fog machine ON, and then turn FOGGING GRIM REAPER'S™ switch to the "ON" position. Move in front of the item. If no fog appears, press the relay switch on the CONTROL BOX.

**WARNING**

Only for use with 400 watt (preferably) or 1000 watt fog machines.  
 Do not use with any other fog machine.  
 Manufacturer does not guarantee the performance of the fog machine.  
 Make sure to use the supplied fog machine components when hooking up to the fog machine, or damage could occur.

**OPTIONAL EXTERNAL SPEAKER SET UP**  
 EXTERNAL SPEAKER IS NOT INCLUDED. MUST BE PURCHASED SEPARATELY.

1. Plug speaker cord into the jack labeled SPEAKER JACK located on side of the control box.
2. Use volume knob on external speaker to control volume levels.

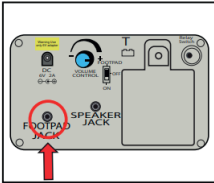

**OPTIONAL FOOTPAD SET UP**  
 FOOTPAD IS NOT INCLUDED. MUST BE PURCHASED SEPARATELY.

1. Insert the cable from optional footpad into the jack labeled FOOTPAD on the control box.
2. Place the switch in the FOOTPAD position to enable FOOTPAD activation.
3. Step on the FOOTPAD to activate the scary sequence!

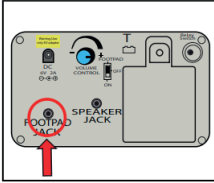

**OPTIONAL SHELTERED OUTDOOR GROUND STAKES SETUP**

For additional sheltered outdoor stability, hammer the METAL STAKES through the metal loops located on the METAL STAND to secure.



**\*Footpads, adapters and all other accessories are sold separately.**

# IMPORTANT SAFETY INSTRUCTIONS



## Warnings

- This product is for decoration only and is not a toy. Small parts and choking hazard. Use caution with children under the age of 14.
- Do not position the decoration near candles, sources of heat, or in direct sunlight.
- The decoration cannot be connected to the power supply directly.
- Decoration should be on a level, stable surface to prevent it from falling over
- This product is fragile and should be assembled with care.
- Surface washable only.
- Please follow the steps and requirements specified in the instruction to ensure safety and reliability during the installation.

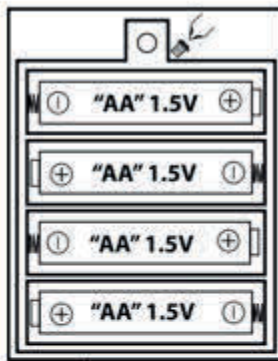

### BATTERY INSTRUCTIONS AND CAUTIONS

Battery installation and removal should be performed by an adult.

Remove batteries when not in use.

Use only batteries recommended in the instructions.

Do not mix new and used batteries.

Do not mix alkaline, carbon-zinc, nickel-cadmium, rechargeable or different types of batteries.

Be mindful to insert batteries with the correct polarity (+/-) as indicated.

Remove all exhausted batteries.

Rechargeable batteries are only to be charged under adult supervision.

Rechargeable batteries are to be removed from the item before being charged.

Non-rechargeable batteries are not to be recharged.

The supply terminals are not to be short-circuited.

Always dispose of exhausted batteries properly.

Do NOT dispose of batteries in fire, they may leak or explode.

**Warning! This item is not a toy. For decoration only. Small parts, choking hazard.  
This product is intended for use by persons 15 years of age and older.  
Not intended for use by children ages 14 years and younger.**

**WARNING  
DO NOT TURN ITEM ON UNTIL YOU HAVE COMPLETELY FINISHED ASSEMBLY.  
STAY CLEAR OF ITEM WHILE OPERATING.  
DO NOT PLACE ITEM ON UNEVEN GROUND.  
DO NOT PLACE WEIGHT ON ITEM WHILE IN OPERATION.**

**Storage tips:** We suggest saving the carton for storing your figurine. Store in a cool, dry area where the temperature does not exceed 100°F.





# 1-Year Limited Warranty

"Limited" Warranty Program

For a period of one (1) year after purchase, Haunted Hill Farm ("Manufacturer") will either repair or replace defective components in accordance with this Limited Warranty.

*Sales and use taxes, plus shipping and handling charges are the responsibility of the consumer.*

This warranty is between Manufacturer and the original purchaser and is valid only when accompanied by the original purchaser's sales receipt showing original date of purchase and location of purchase. Replacements under this warranty revert back to the date of original purchase for future warranty.

Manufacturer or its authorized dealer can accept or reject warranty claims based on its findings. This warranty applies in normal residential use only, where an issue with the product is due to a defect in material or workmanship. Manufacturer can make substitutions as required of materials, components, and sub-components of comparable value and utility. This warranty is limited to product repair or replacement (to be determined solely by Manufacturer). Warranty return is limited to only the single affected component.

This warranty covers only manufacturing defects and does not cover normal wear and tear, abuse or misuse, including: water damage, chemical damage, exposure to extreme heat or cold, abrasion or excessive weight. This product is intended to be used with standard ornaments only. This warranty is invalid if the product is not used for intended purpose. Manufacturer disclaims liability for any aspect of installation and any inconvenience caused by a defective part or component.

Certain items are not covered by this warranty. These include, but are not limited to the following:

1. Components subjected to abuse, including abuse intended to simulate failure.
2. Damages caused by retailer, shipper or installation crew (such as scratches, dents, tears, etc.).
3. Any part which merely exhibits normal wear yet functions essentially as new, including stretching of materials and stitching.
4. Tears, punctures, scratches or any damage caused by improper installation or use.
5. Items sold "as is" or floor models.

To make a claim, send a copy of the original sales receipt along with a brief description of the problem to the email address below. Please include your email address and daytime telephone or cell phone #. All items may be charged actual freight and handling costs. Repairs or replacement will be made at the Manufacturer's option.

**THIS IS THE ENTIRE EXCLUSIVE EXPRESS LIMITED LIABILITY. THE MANUFACTURER NEITHER MAKES NOR IS RESPONSIBLE FOR ANY OTHER WARRANTIES, EITHER EXPRESS OR IMPLIED, INCLUDING THOSE OF RETAILING DEALERS. THIS EXCLUSIVE REMEDY IS LIMITED TO RECEIPT OF A CREDIT IN CONNECTION WITH THE REPAIR OR REPLACEMENT OF ANY PRODUCT OR COMPONENT DEEMED TO BE DEFECTIVE UNDER THE TERMS AND CONDITIONS AS STATED IN THIS WARRANTY. NEITHER HAUNTED HILL FARM, THE PRODUCT MANUFACTURER NOR ITS AGENTS SHALL BE LIABLE IN ANY CASE FOR INCIDENTAL, INDIRECT, SPECIAL OR CONSEQUENTIAL DAMAGES RESULTING FROM THE USE OF THIS PRODUCT OR ARISING OUT OF ANY BREACH OF THIS WARRANTY OR NEGLIGENCE EVEN IF IT HAS BEEN ADVISED OF THE POSSIBILITY OF SUCH DAMAGES. EXCEPT AS OTHERWISE MAY BE REQUIRED BY LAW, THERE ARE NO OTHER EXPRESS OR IMPLIED WARRANTIES OTHER THAN THE WARRANTY DESCRIBED HEREIN, AND ALL OTHER WARRANTIES, INCLUDING ANY IMPLIED WARRANTY OF MERCHANTABILITY OR FITNESS FOR A PARTICULAR PURPOSE ARE EXPRESSLY DISCLAIMED.**

**Boo@HauntedHillFarm.com**

**1-888-840-4559**