

KREE Series

5-Function Handshower
with Slide Bar



Installation/Installation/Instalación

CUSTOMER SERVICE

TOLL-FREE 1-888-OK-ULTRA (658-5872)

UF78300-7 - Chrome

UF78303-7 - Brushed Nickel

UF78307-7 - Matte Black

UF78308-7 - Brushed Gold

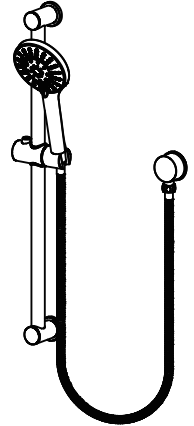

Tools You Will Need / Outils dont vous aurez besoin / Herramientas necesarias



Pencil



Drill

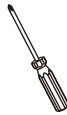

Phillips Screwdriver



Level

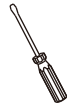

Flat Head Screwdriver

SAFETY TIPS

- If you use soldering for the installation of the faucet, the seats, cartridges and washers will have to be removed before using flame. Otherwise, warranty will be void on those parts.
- Cover your drain to avoid losing parts.
- 0°C~55°C.

CONSIGNES DE SÉCURITÉ

- Si vous posez le robinet par brasage, il est essentiel de retirer les sièges, les cartouches et les rondelles avant d'appliquer la flamme, faute de quoi la garantie sur ces pièces sera annulée.
- Couvrez le drain pour ne pas perdre des pièces.
- 0°C~55°C.

CONSEJOS DE SEGURIDAD

- En el caso de utilizar soldadura para instalar el grifo, remueva los asientos, cartuchos y arandelas antes de usar la llama. De lo contrario, se anulará la garantía para esos componentes.
- Tape la boca del desagüe para prevenir la pérdida de piezas pequeñas.
- 0°C~55°C.

Replacement Parts / Pièces de rechange / Repuestos

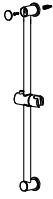

Slide Bar X1



Hose X1



Hand shower X1



Elbow X1



Gasket X1

Installation/Installation/Instalación

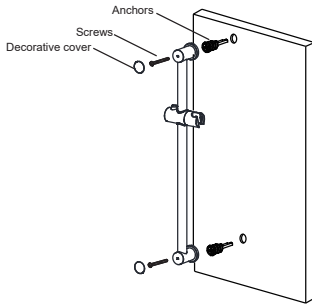

1. Use a pencil to mark the installation holes position before drilling installation holes.
2. Drill two installation holes after positioning the holes.
3. Put the anchors into the installation hole as showed;
4. Take off the decorative cover from fixing base;
5. Make screw respectively through the center of fixing base and anchor then use screwdriver to tighten and fix the screw into wall.
6. Put the decorative cover into fixing base.

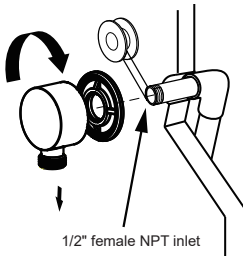

SUPPLY OUTLET INSTALLATION

Minimum diameter for hole is 1" (25 mm) with a maximum of 1 1/2" (38 mm). Apply Plumber tape to threaded ends of 1/2" (13 mm) pipe nipple (not supplied) and thread into shower riser elbow so that nipple extends past the finished wall no more than 7/10" (18 mm) and no less than 2/5" (10.5 mm). Place the supplied installation gasket behind the elbow. Screw the supply elbow onto the nipple making sure that the supply elbow outlet is in a downward facing position. CAUTION: To avoid damage to the supply elbow or hose finish during installation, wrap with a cloth or tape and use only a smooth-jawed wrench. DO NOT OVERTIGHTEN CONNECTIONS.

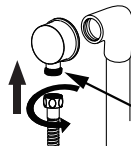

G1/2" male outlet for connecting to shower hose

1. Attach the shower hose to the threaded supply outlet and proceed with the installation of the hand shower, following the manufacturers instructions. CAUTION: To avoid damage to the supply elbow or hose finish during installation, wrap with a cloth or tape and use only a smooth-jawed wrench.
2. Connect the handheld shower and the shower hose by hand and put the hand shower into the slider. DO NOT OVERTIGHTEN CONNECTIONS.

Limited Lifetime Warranty

Ultra Faucets warrants to the original purchaser that its products will be free from defects in workmanship and materials. All Ultra Faucets are provided with a life time limited warranty. This warranty does not cover any other labor or service charges associated with the removal, repair, or reinstallation of Ultra Faucets products. This express warranty does not apply to products that have been damaged as a result of misuse, abuse, negligence, accident, faulty installation or maintenance practices and/or used in any manner contrary to those recommended by the manufacturer.

Need help? Please call our toll-free customer service line at 1-888-658-5872 for additional assistance or service.

Besoin d'aide? Veuillez communiquer avec notre service à la clientèle au numéro gratuit 1-888-658-5872 pour tous renseignements ou services complémentaires.

¿Requiere asistencia? Llame a nuestro Servicio al Cliente, sin costo, al 1-888-658-5872 para asistencia adicional o servicio.