

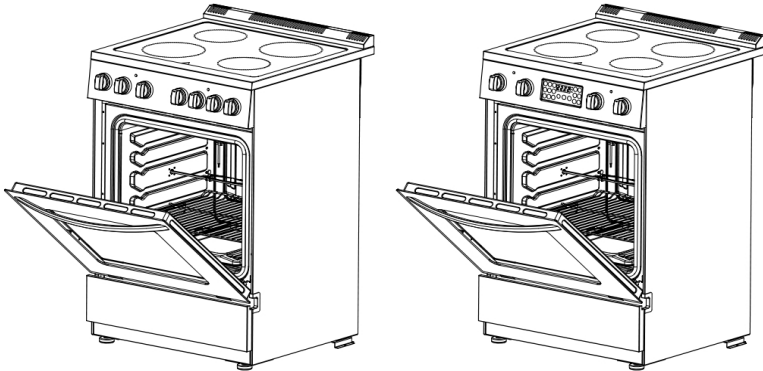

# USER MANUAL



Actual design or color may vary.

**FREESTANDING/SLIDE-IN ELECTRIC RANGE**  
24" Wide

Model: LB-ERT24RC-S  
LB-ERK24RC-B  
LB-ERK24RC-W

**BEFORE USE, PLEASE READ AND FOLLOW ALL SAFETY RULES AND OPERATING INSTRUCTIONS**

Lanbo has a policy for continuous improvement on its products and reserves the right to change materials and specifications without notice



# Table of Content

<b>Customer Service</b> .....	2
<b>Explanation of Symbols</b> .....	3
<b>Important Safety Instructions</b> .....	3
<b>Parts &amp; Cooktop</b> .....	9
<b>Before Using Your Electric Range</b> .....	13
Each Box Contains.....	13
Important Precautions and Recommendations.....	15
<b>Installation</b> .....	16
Installation of Electric Range.....	16
<b>Using the Surface Units</b> .....	21
Cookware Tips.....	21
<b>Using the Electric Oven</b> .....	22
Operate for Electric Control.....	22
Operate for Mechanical Control.....	29
<b>Care &amp; Maintenance</b> .....	31
<b>Trouble shooting</b> .....	36
<b>Warranty</b> .....	38

# Customer Service

## CONGRATULATIONS

Thank you for purchasing your new Lanbo Appliances product. We are confident you will be pleasantly surprised with the simplicity of use. Before installing and operating your new appliance, please be sure to thoroughly read through this manual for product description, functions, and warnings. Please keep and save this instruction manual for future reference. To ensure our ability to continue serving you, please use this page to record important product information.

Write down purchase date, the model and serial numbers. Find them on a label located on the rear outside wall of the appliance.

Please write these numbers here:

Purchase date:

---

Model Number :

---

Serial Number:

---

**You will need your model and serial number when contacting support.**

**Thank you for your trust and support in LANBO INTERNATIONAL INC!**

**For assistance or questions regarding your product, please contact our customer service team at [service@lanboappliances.com](mailto:service@lanboappliances.com).**

**For telephone support, pls call 626-348-4991.**

# Explanation of Symbols

This manual has safety information and instructions to help you eliminate or reduce the risk of accidents and injuries. Always respect all safety warnings identified with these symbols. A signal will identify safety and property damage messages and will indicate the degree or level of hazard and seriousness.

## **WARNING**

Indicates a potentially hazardous situation which, if not avoided, could result in death or serious injury.

## **CAUTION**

Indicates a potentially hazardous situation which, if not avoided, may result in minor or moderate personal injury, or property damage.

## **DANGER**

Indicates an imminently hazardous situation which, if not avoided, will result in death or serious injury.

# Important Safety Instructions

Before operating the electric range, make sure it is properly installed by following instructions in this manual.

Carefully read and follow all safety instructions mentioned in this manual to avoid hazards of fire, burn, electrical shock, personal injury or even death.

## PLEASE READ CAREFULLY

- A separate outlet serving only the appliance is recommended. Use outlets that cannot be turned off by a switch or pull chain.
- Never clean any parts of the appliance with flammable fluids, fumes of which can cause hazards of fire or explosion.
- Do not store or use gasoline or other flammable vapors and liquids in the vicinity of this or any other appliances, fumes of which can cause hazards of fire or explosion.
- Make sure the power line of the appliance is disconnected before performing cleaning and maintenance operations.
- Unplug the appliance from outlet or disconnect power source before cleaning or maintenance. Risk of electrical shock or even death may occur.
- Do not repair or replace any parts of the appliance by yourself unless before consulting a qualified technician or the part is specifically recommended in the manual. All other maintenance should be conducted by a qualified service technician.
- Electrical grounding instructions - the appliance must be installed and grounded by a qualified technician in accordance with the National Electrical Code ANSI/NFPA No. 70 (Latest Edition) and local electrical code requirements.
- Do not carry out cleaning or maintenance operations on the appliance unless its power supply is totally shut off.
- **Fire risk!** Do not store flammable material in the oven or in the bottom drawer.
- **Fire risk!** Do not attempt to dry clothing or any other type of textile in the oven or in the bottom drawer.
- Make sure that electrical cables connecting other appliances in the proximity of the range cannot come into contact with the hob or become entrapped in the oven door.
- **Danger of burns!** The oven and cooking accessories may become very hot during or after use. Keep children away from the hot parts and refer to warnings. To avoid burns use kitchen gloves when handling hot parts or utensils.
- Stand away from the range when opening oven door. Hot air or steam can cause burns to hands, face, and/or eyes.
- Never clean the oven with a high-pressure steam cleaning device, as it may cause a short circuit.

**Important Precautions and Recommendations for Use of Electrical Appliances:** Use of any electrical appliance must follow a series of fundamental rules. In particular:

- Never touch the appliance with wet hands or feet.
- Do not operate the appliance barefoot.
- Do not allow children or disabled people to use the appliance without proper supervision.

### Electrical Grounding Instructions:

**FOR PERSONAL SAFETY, THIS APPLIANCE MUST BE PROPERLY GROUNDED.**

**This household cooking appliance is not equipped with power cord and a plug.**

**Do not under any circumstances cut or remove the third (ground) prong from the power plug.**

**Electrical installation should comply with national and local codes.**

## **WARNING**

If the safety instructions in this manual are not followed correctly, a fire or explosion may occur and result in appliance damage, personal injury or even death.

- This appliance shall not be used for space heating. The surface unit should not be operated without cookware.
- All openings in the wall behind the appliance and in the floor under the appliance shall be sealed.
- Keep appliance area clear and free from combustible materials, gasoline, and other flammable vapors or liquids.
- Always keep the flow of ventilation unblocked.
- If the power fails, always turn the oven off.
- Never leave surface units unattended at high heat settings.
- When removing appliance for cleaning and/or service:
  - Disconnect AC power supply.
  - Carefully remove the range by using a rolling lift jack to pull it outward.

**CAUTION:** Take care when removing the range due to the weight of the unit.

- Improper use of the oven door, such as stepping, sitting, leaning, or placing heavy items on it, can result in door damage or potential hazards and/or injuries.
- Do use a rolling lift jack when installing the electric range or removing it for service. Do not attempt to slide it into or out of installation position by pushing or pull against any edges of the appliance, due to which the leg spindles or the internal coupling connectors might be bent.
- It is important to level the appliance for the purpose of operating normally. The appliance can be leveled by adjusting the four leveling legs at the bottom of it.
- Never allow children to operate, play with or crawl inside the appliance.
- Do not attempt to operate the oven during a power failure. If the power fails, always turn the oven off. If the oven is not turned off and the power resumes, the oven may begin to operate again. Food left unattended could catch fire or spoil.

## **WARNING**

To prevent or reduce the risk of fire, electrical shock or injury when using the range, follow these basic precautions:

- Read all instructions before using the range.
- Do not store items of interest to children in cabinets above a range or on the backsplash of a range – children climbing on the range to reach items could be seriously injured.
- Proper Installation - Be sure the range is properly installed and grounded by a qualified technician.
- Never use your appliance for warming or heating the room.
- Do not leave children alone - children should not be left alone or unattended in area where the appliance is in use. They should never be allowed to sit or stand on any part of the appliance.
- Do not store flammable materials in or on a range or near the surface units.
- Do not use water on grease fires - smother fire or flame or use dry chemical or foam- type extinguisher.
- Use only dry potholders - moist or damp potholders on hot surfaces may result in burns from steam. Do not let potholder touch hot heating elements. Do not use a towel or other bulky cloth.
- Use proper pan size - this appliance is equipped with one or more surface units of different sizes. Select cookware having flat bottoms and large enough to cover the heating element of the surface unit. The use of proper size cookware or pans will improve heating efficiency.
- Never leave surface units unattended at high heat settings – boil over causes smoking and greasy spillovers that may ignite.
- Make sure reflector pans or drip bowls are in place - absence of these pans or bowls during cooking may subject wiring or components underneath to be damaged.
- Protective liners - do not use aluminum foil to line surface unit drip bowls or oven bottoms, except as suggested in the manual. Improper installation of these liners may result in the risk of electric shock, or fire.
- Glazed cookware - only certain types of glass, glass/ceramic, ceramic, earthenware, or other glazed cookware are suitable for range top service without breaking due to sudden change in temperature.
- Cookware/pan handles should be turned inward and not extend over adjacent surface units – to minimize burns, ignition of flammable materials, and spillage due to unintentional contact with the cookware/pan handle
- Do not soak removable heating elements – heating elements should never be immersed in water.
- Do not cook on broken cooktop, in which cleaning solutions and spillovers may penetrate and cause electric shock. Contact a qualified technician immediately if the cooktop is broken.



- Clean cooktop with caution – if a wet sponge or cloth is used to wipe spills on a hot cooking surface, be careful to avoid steam burn. Some cleaners can produce toxic fumes if applied to a hot surface.
- Take care when opening cookware/pan lid or oven door – let hot air or steam escape before removing or replacing food.
- Do not heat unopened food containers – build-up of pressure may cause container to burst and result in injury.
- Keep oven vent ducts unobstructed.
- Placement of oven racks – always place oven racks in desired location while oven is cool. If rack must be moved while oven is hot, do not let potholder contact hot heating element in oven.
- During and after use, do not touch or let clothing or other flammable materials contact surface units, areas near units or interior surfaces of oven until they have had sufficient time to cool down, which may be hot even though they are dark in color. Other surfaces of the appliance, such as oven vent, doors, window and so on, may also become hot enough to cause burns.

**This Unit Is for Indoor Use Only.  
Save These Instructions for Future Reference.**

## CAUTION

### **Replacement Parts**

- Only authorized replacement parts may be used in performing service on the range.
- Replacement parts are available from factory authorized parts distributors. Contact the nearest Lanbo distributors in your area.

# **⚠ DANGER**

Possible range tip-over hazard, causing appliance damage or personal injury!



## **⚠ WARNING**

Secure anti tip bracket to avoid range tipping over if too much force or heavy load is applied to the open door.

Appliance damage or personal injury may result due to range tipping over.

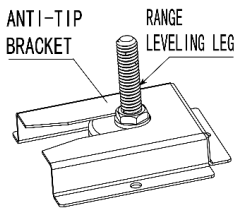

To reduce the risk of tipping, the appliance must be secured by properly installing anti-tip brackets included with the appliance.

For installation of anti-tip bracket, please refer to the section of Anti-tip Bracket Installation in Page 18.

# Parts & Cooktop

Parts of Model: LB-ERT24RC-S

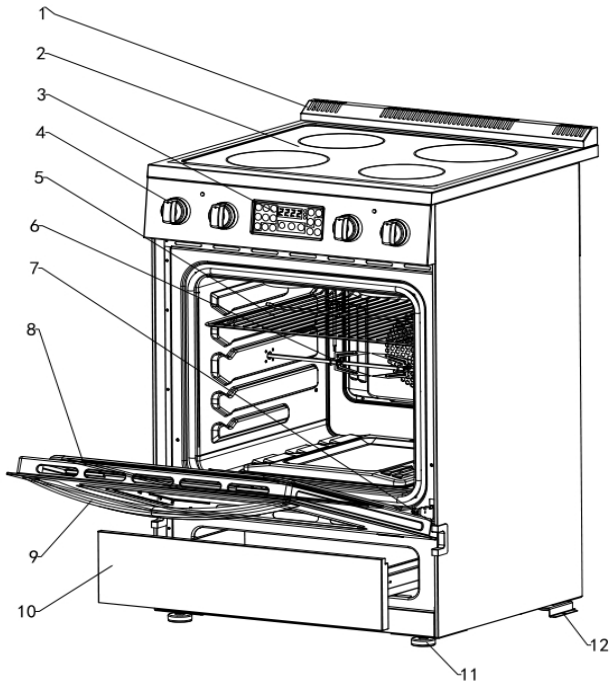

1	Backsplash with Integrated Oven Vents	2	Ceramic Glass Cooktop
3	Control Panel with Digital Display	4	Control Knob
5	Oven Rack	6	Rotisserie
7	Oven Door Hinge	8	Oven Door
9	Oven Door Handle	10	Storage Drawer
11	Leveling Feet	12	Anti-tip Bracket

## Cooktop of Model: LB-ERT24RC-S

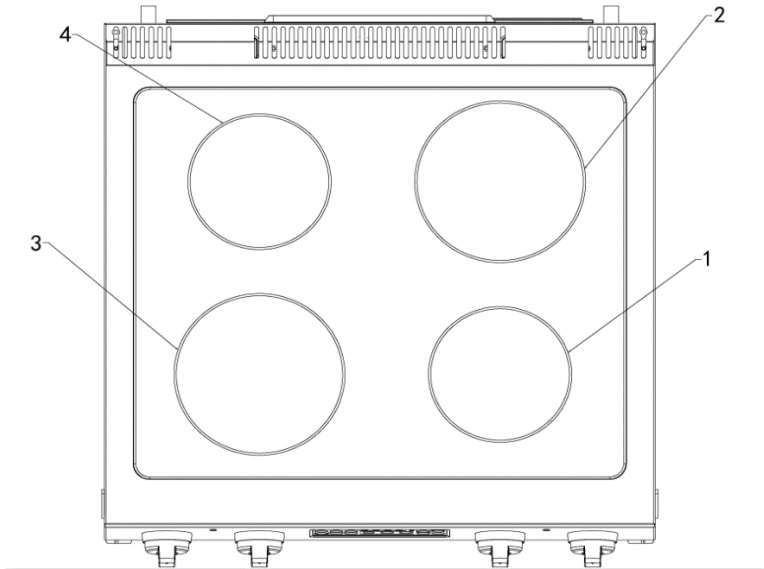

<b>1</b>	<b>Front right element</b>	<b>3</b>	<b>Front left element</b>
<b>2</b>	<b>Rear right element</b>	<b>4</b>	<b>Rear left element</b>

**Parts of Model: LB-ERK24RC-B and LB-ERK24RC-W**

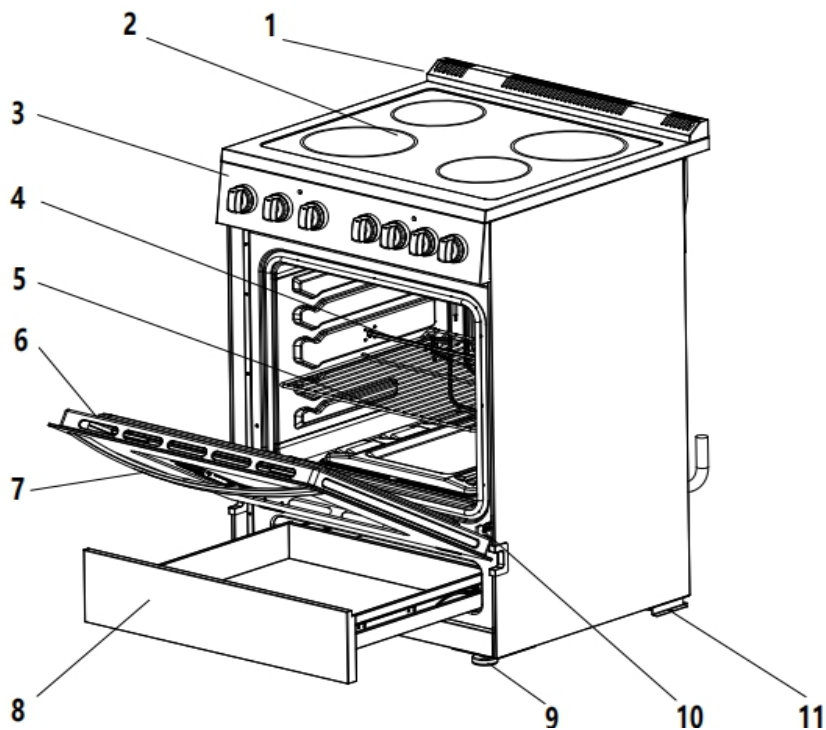

1	<b>Backsplash with Integrated Oven Vents</b>	2	<b>Ceramic Glass Cooktop</b>
3	<b>Control Panel with Control Board</b>	4	<b>Rotisserie</b>
5	<b>Oven Rack</b>	6	<b>Oven Door</b>
7	<b>Oven Door Handle</b>	8	<b>Storage Drawer</b>
9	<b>Leveling Feet</b>	10	<b>Oven Door Hinge</b>
11	<b>Anti-tip Bracket</b>		

Cooktop of Model: LB-ERK24RC-B and LB-ERK24RC-W

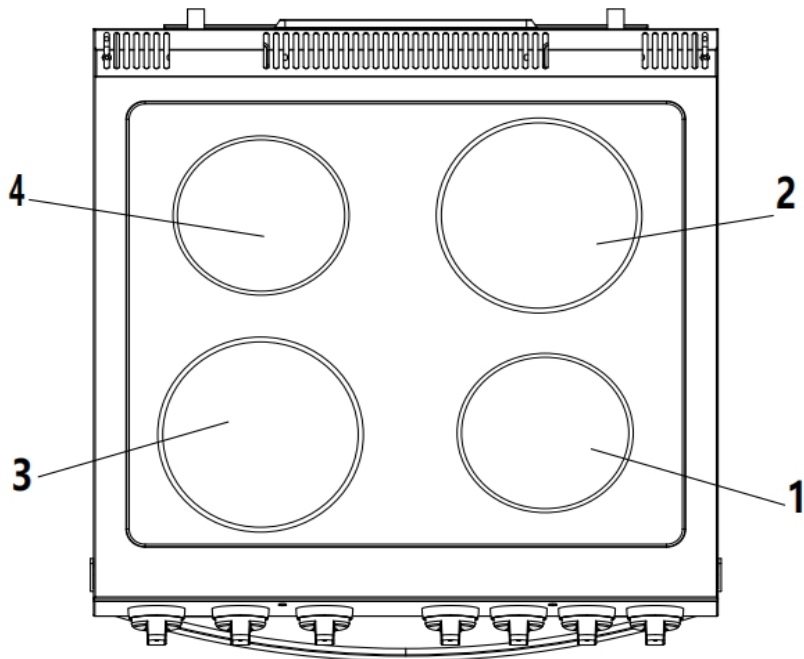

<b>1</b>	<b>Front right element-</b>	<b>3</b>	<b>Front left element</b>
<b>2</b>	<b>Rear right element</b>	<b>4</b>	<b>Rear left element</b>

<b>Element location</b>	<b>Heating element type</b>	<b>Heat element size</b>	<b>Rating power</b>
Front right	Ceramic	165mm	1200W
Front left	Ceramic	200mm	1800W
Rear right	Ceramic	200mm	1800W
Rear left	Ceramic	165mm	1200W

# Before Using Your Electric Range

**NOTE:** The manufacturer shall accept no liability for injury to persons or damage to property caused by incorrect or improper use of the appliance.

Remove the exterior and interior packaging.

Remove the protective film on steel and aluminum parts.

Check that all of the parts listed below are included in the box.

## Each Box Contains:

- Backsplash Assembly x 1 (Backsplash with 2 screws)
- Oven Racks x 2
- Rotisserie x 1
- Anti-tip Bracket x 2 with 6 expansion screws
- Instruction Manual x 1
- Bottom Cover x 1
- Oven Drip Pan X1

## WARNING

THE INSTALLATION OF THE ELECTRIC RANGE MUST BE CARRIED OUT BY QUALIFIED PERSONNEL.

Improper installation, adjustments, alterations, services, or maintenance can result in property damage, personal injury, or death. For any problems or concerns, please consult a qualified personnel and service company.

- Clean the interior surface by using a soft cloth with lukewarm water.
- Have your range installed and properly grounded by a qualified installer in accordance with the installation instructions.
- Do not repair or replace any parts of the appliance by yourself unless you consult a qualified technician or the part is specifically recommended in the manual.
- Do not remove permanently affixed labels, warnings, or plates on the appliance, otherwise which may void the warranty.
- These instructions should be kept with consumer for future reference and local inspector's inspection.
- Please observe all local and national codes and ordinances.

## NOTICE

### **Before you use this range for the first time:**

The heating elements have a protective coating, which must be burned off before use. To do this, set the temperature to 450°F. Turn the function selector to the Bake element and the Broil element separately for approximately 15 minutes. It is important to ensure adequate ventilation during this period.

The burners also have a protective coating, which must be burned off before use. To do this, set the burner selector to the maximum setting for 5 minutes. It is important to ensure adequate ventilation. Switch off the burners and allow to cool down completely.

### **IMPORTANT:**

This range is designed and manufactured solely for household cooking only and CANNOT be used in a commercial environment.

The range warranty will be void if the range is used in a non-household environment, for example, in a semi-commercial, commercial, or communal area.



## Important Precautions and Recommendations

After the electric range has been unpacked, check for any damages to the appliance and that the oven door opens and closes normally. Any problems or concerns, please do not use the appliance and consult your dealer or qualified technician.

Packaging materials (for example, plastic bags, polystyrene foam, nails, packing straps, etc.) should be kept out of reach of children, to avoid serious injuries. The range has been thoroughly tested for safe and efficient operation. However, as with any appliance, there are specific installation and safety precautions that must be followed to ensure safe and satisfactory operation.

Packaging materials are recyclable and marked with the recycling symbol .

- Do not attempt to modify the technical characteristics of the appliance as it may result in damage to the appliance and hazards to users.  
**NOTE:** Ensure all the control knobs are in **OFF** position after use.
- Keep children away from the range when it is in use.
- Check to be sure that no range parts have come loose during shipping.
- Provide adequate clearances between the range and adjacent walls.
- Do not line the oven walls top and bottom with aluminum foil. Do not place shelves, pans, backing trays broil tray or other cookware on the base of the oven chamber.
- To prevent appliance damage, short circuit, electric shock or any other possible hazards, the installation, maintenance, and repair should **ONLY** be carried out by qualified personnel. **DO NOT** attempt to repair the appliance by yourself!
- After use, ensure that the knobs are in **OFF** position.
- During and after use of the range, certain parts will become very hot. Do not touch hot parts.
- To avoid any possible hazards, the appliance must be installed by qualified personnel only. Any repairs by unqualified persons may result in electric shock or short circuit. To avoid possible injuries to your body or to the range, do not attempt any repairs by yourself. Such work should be carried out by qualified service personnel only.
- Do not leave anything on the top of oven vent. Never cover the vent opening with aluminum foil or any other material.
- This range is intended for household use. Never use the appliance for any other purpose. If you should decide not to use the range any longer (or decide to substitute an older model), before disposing of it, it is recommended that it be made inoperative in an appropriate manner in accordance with health and environmental protection regulations, ensuring in particular that all potentially hazardous parts be made harmless, especially in relation to children who could play with old appliances. Remove the door before disposal to prevent entrapment.

# Installation

## Installation of Electric Range

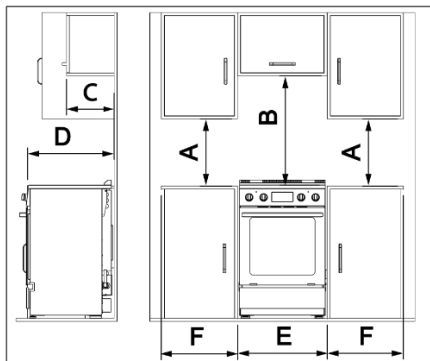

Dimension

A	B	C	D	E	F	G
Minimum 18" (457 mm)	Minimum 30" (762 mm)	Maximum 13" (330 mm)	Minimum 26" (660 mm)	24.8" (630 mm)	Recommend 20" (508 mm)	Recommend 36 1/2" (927 mm)

The electric range must be installed by a qualified technician. Make sure you have everything necessary for correct installation. It is the installer's responsibility to comply with installation clearances specified in the manual.

- Cabinet opening dimensions that are shown above must be used. Given dimensions are minimum clearances. The minimum spacing must be maintained between the appliance cooking surface and the horizontal surface above the cooking top.
- 30 inches is the minimum clearance between the top of the cooking surface and the bottom of an unprotected wood or metal cabinet.
- To eliminate the risk of burns or fire by reaching over heated surface units, cabinet storage space located above the surface units should be avoided. If cabinet storage is to be provided, the risk can be reduced by installing a range hood that projects horizontally a minimum of 5 inches beyond the bottom of the cabinets.
- Place your electric range on a floor that is strong enough to support it when it is fully assembled as above picture. To level your electric range, adjust the leveling legs at the bottom of the unit.

- Avoid installing the unit in moist areas, as this may result in the risk of electrical shock.

## Installation of the Backsplash

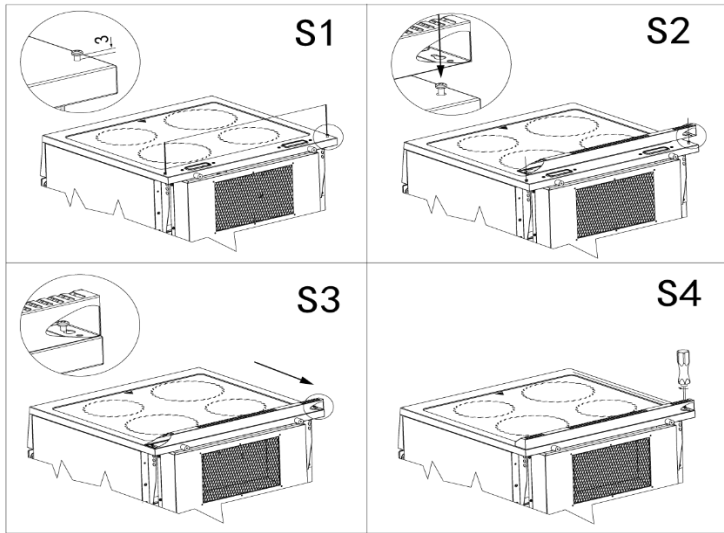

1. Fix 2 screws (ST4\*12) to the corresponding hole at the back of cover, leaving about 3mm gap (S1).
2. Put the backsplash plate on the cover make the big holes through the heads of the screws (S2).
3. Push the backsplash plate making the small holes align the screws (S3).
4. Tighten the screws use driver (S4).

## Leveling the Range

The electric range must be installed levelly for proper operation. There are four screw-type leveling legs at the bottom of the range for you to adjust the level of the range, rotating clockwise to rise and counterclockwise to lower the height. Use a leveling instrument to check the level of the range.

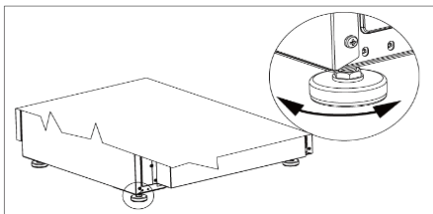

## Anti-Tip Bracket Installation

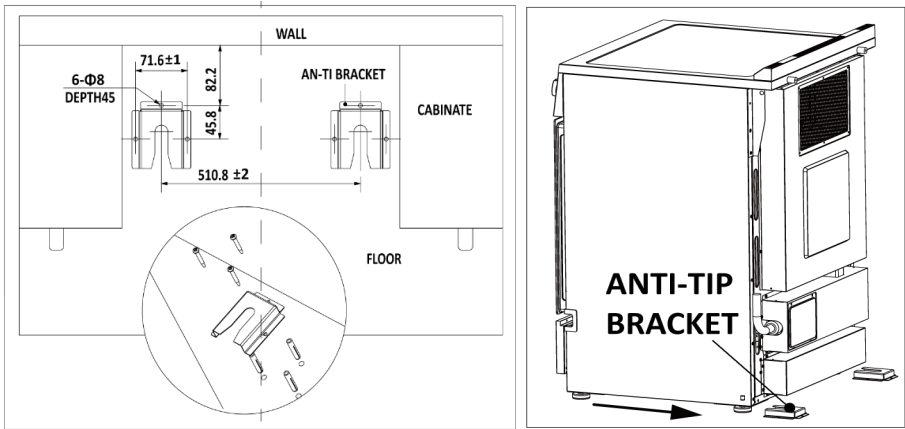

To prevent the range from tipping over due to improper use or overloading the open door, an anti-tip bracket (included in the package) must be installed properly by following instructions below. The anti-tip bracket can be fixed at either the left or right side of the appliance.

1. Place the anti-tip bracket on the floor where the range is going to be installed.
2. Locate and mark the drill position through the 6 holes in the bracket. And then place the bracket aside.
3. Use  $5/16''$  masonry drill to drill two holes in suitable depth.
4. Insert 6 plastic anchors into the 6 holes and place the bracket back.
5. Fix the bracket on the floor by using screws supplied.
6. Slide the appliance in position.

**NOTE:** If range is relocated, the bracket must be removed and installed in new location.  
Install the anti-tip bracket either right or left side.

## Electric Connection

### WARNING

Improper grounding can result in the risk of electric shock. If the power cord is damaged, have it replaced by an authorized LANBO Products service center.

- The appliance must be properly installed and grounded by a qualified technician in accordance with the National Electrical Code ANSI/NFPA No. 70 (Latest Edition) and local electrical code requirements. Installation should be made by a licensed electrician.
- The range may be connected by means of permanent “Hard Wiring” or “Power Supply Cord Kit”. Power supply cord is not supplied for USA market but is available through your local electric or hardware center.
- Use only 3-conductor or 4-conductor UL listed range cord rated at 40 amps, 8AWG with 125/250V minimum voltage range. These cords may be provided with strain relief or conduit connector.
- The range must be connected to the proper electric voltage and frequency as specified on the rating label.
- The range can be connected directly to the fused disconnect (or circuit breaker box) through flexible, armored or non-metallic sheathed, copper cable (with grounding wire). Allow two to three feet of slack in the line so that it can be moved if servicing is necessary.
- **For personal safety, the range must be properly grounded.**
- Remove house fuse or open circuit breaker before beginning installation.
- Do not repair or replace any parts of the appliance by your own unless the repair is allowed and the parts are recommended by the manufacturer. All other maintenance should be made by a qualified technician.
- To minimize the possibility of electric shock, disconnect this appliance from the AC power supply before attempting any maintenance.

**NOTE:** Turning the appliance off does not disconnect the appliance from the power supply. We recommend having a qualified technician to service your appliance.

### 3-Wire Power Cord Installation

Remove the Terminal Block Access Plate on the back of range by removing the fixing screw.

- Loosen the screws securing the strain relief bracket.
- Insert all 3 power cords (L1, L2, Grounding) passing through the bracket.
- Loosen the 2 power leads terminal (L1, L2) nuts and washers on the terminal block
- Plug the 2 wire terminals into the terminal block as shown, and then tighten the nuts.
- Loosen the ground nut and plug grounding wire terminal into the nut as shown. Then tighten the nut.
- Tighten the screws of bracket when all cords are plugged and secured.
- Assemble the Terminal Block Access Plate.

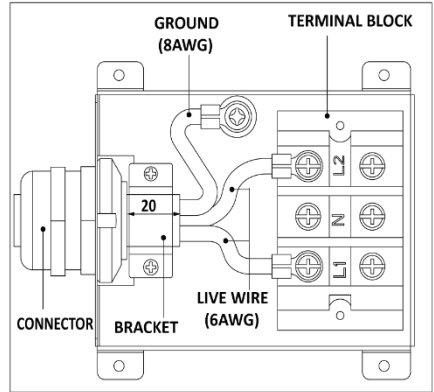

### 4-Wire Power Cord Installation

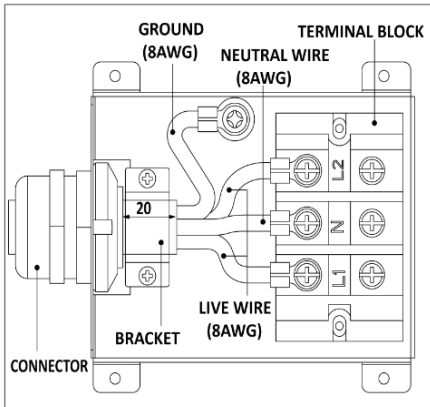

Remove the Terminal Block Access Plate on the back of range by removing the fixing screw.

- Loosen the screws securing the strain relief bracket.
- Insert all 4 power cords (L1, L2, N, Grounding) passing through the bracket.
- Loosen the 3-power cord terminal (L1, L2, N) nuts and washers on the terminal block
- Plug the 3 wire terminals into the terminal block as shown, and then tighten the nuts.
- Loosen the ground nut and plug grounding wire terminal into the nut as shown. Then tighten the nut.
- Tighten the screws of bracket when all cords are plugged and secured.

- Assemble the Terminal Block Access Plate.

**NOTE:** The neutral wire of the power cord must be connected to the neutral terminal located in the center of terminal block. The ground wire of the power supply cord must be attached to the frame of range by using the green colored grounding screw. The power leads must be connected to L1 and L2.

# Using the Surface Units

Your range is equipped with four surface units of two different sizes. The surface control knobs are easily operated. Simply push in and turn the knob to the desired position. When the element is ignited the indicator light will be lit regardless of the setting when one or more of the elements are turned on.

The control knob has a variable of power output from LO to HI with a number of positions. The range of heat is increased by turning the knob to HI, decreased by turning the knob to LO.

**IMPORTANT: To switch on, always lightly press the control knob inwards then rotate.**

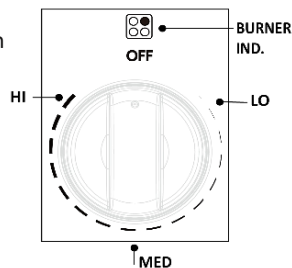

## Cookware Tips

The physical characteristics of pots and pans influence the performance of any cooking system. Therefore, emphasis must be placed on the choice of proper cookware.

- Use cookware with flat bottoms and tight-fitting lids to conserve energy and shorten cooking time.
- Be sure you know which control knob operates each surface unit. Make sure you turned on the correct surface unit.
- Only certain types of glass, glass/ceramic, ceramic, earthenware or other glazed cookware are suitable for cooktop. Manufacturers suggest using low to medium heat selections when using glass cookware.
- Pan size should match the element size. A slightly larger pan covers the entire element and prevents spillovers from contacting the heat surface and burning in. Using a smaller pan than the element is a waste of energy.
- Clean your cooktop daily or after each use. This will keep your cooktop looking good and can prevent damage.
- To avoid spattering and to maximize efficiency, pan bottoms should be clean and dry before coming in contact with the elements.
- Wipe spills off the elements with a damp cloth as soon as they have cooled down, which will save clean up time if you clean them later. Be sure the control is OFF.
- Prolonged usage of incorrect cookware could result in damage to the surface unit, cooktop, wiring and surrounding areas. To prevent damage, use correct cookware, start cooking on "HI" position and turn control down to continue cooking.
- Never leave empty cookware, or one which has boiled dry, on a hot surface unit to avoid overheating and damage to cookware or surface unit.
- Always be sure that all control knobs are turned to "OFF" position and the indicator lights are OFF when you are not cooking.

## WARNING

Make sure that the handles of cookware do not stick out over the edge of the range to avoid being knocked over by accident. This also makes it more difficult for children to reach the cooking pots/pans.

# Using the Electric Oven

You can use your range for Bake and Broil, which has three different heating elements:

- Bake element 2000W (Lower heating element)
- Broil element 2200W (Upper heating element)
- COV. element 1300W (Back heating element)

**WARNING: The oven door becomes very hot during operation.**

- Keep children well out of reach.
- Use the door handle to open and close the door.
- Use protective gloves to take food out.

## Operate for Electric Control

Control Panel of LB-ERT24RC-S

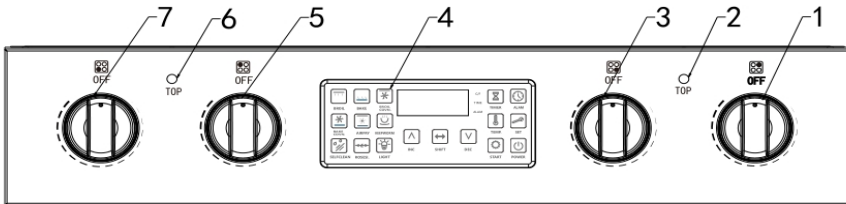

1	Rear right element control knob	5	Rear left element control knob
2	Right top element indicator	6	Left top element indicator
3	Front right element control knob	7	Front left element control knob
4	Electronic oven control		





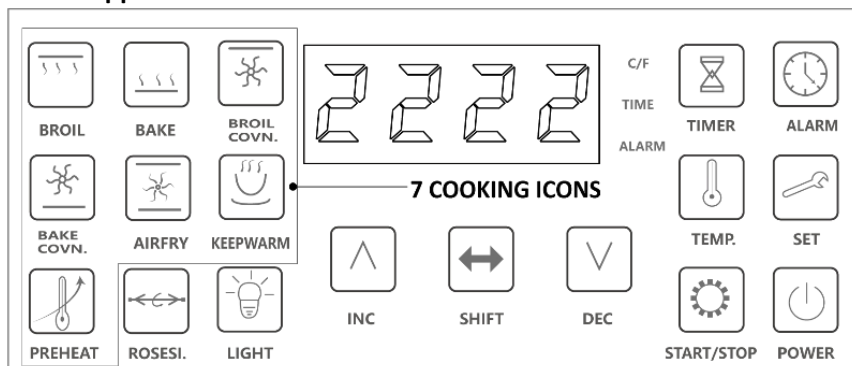



## Screen Appearance























### Timer and ALARM Display Format:

Timer Format: Time display hh:mm and setting from 1:00 to 12:59.





































ALARM Count Format: display hh:mm, and setting depend on different function.





































COOLING FUNCTION PREFERENCE				
Cooking Icon	Use Heat Elem.	Temp. Range(C) (Default)	ALARM Count (M)Range (Default)	Max Power Rate (W)
 BROIL	UPPER HEAT ELEM.	150-250 (230)	1-480(45)	2200
 BAKE	BOTTOM HEAT ELEM.	150-250 (230)	1-480(45)	2000
 BROIL COVN.	UPPER & REAR HEAT ELEM.	150-250 (230)	1-480(45)	3300
 BAKE COVN.	BOTTOM & REAR HEAT ELEM.	150-250 (230)	1-480(45)	3500
 AIRFRY	BOTTOM/ UPPER/ REAR HEAT ELEM.	150-250 (230)	1-480(45)	3500
 KEEPWARM	BOTTOM/ REAR HEAT ELEM.	35-80 (60)	1-480(45)	3300
 PREHEAT	UPPER & REAR HEAT ELEM.	150-200 (200)	5	3300

## FUNCTION & OPERATING



FUNCTION	ICON	OPERATING
POWER ON/OFF	 POWER	Long touch this icon , toggle power turn on/off. When POWER is on, you can use the range.
Timer/ALARM/Temp Setting Following Description below to Set Timer/ALARM/Temp.		
SET TIMER&DISPLAY	 TIMER	Select <b>TIMER</b> icon, then click  enter setting, use    to adjust parameter, and then click  to confirm or click <b>TIMER</b> icon again to cancel.
SET ALARM	 ALAM	Only cooking mode is selected, <b>ALARM</b> setting is permitted. Select <b>ALARM</b> icon, then click  enter setting, use    to adjust parameter, and then click  to confirm or click <b>ALARM</b> icon again to cancel.
SET TEMP.	 TEMP.	Only cooking mode is selected, <b>TEMP</b> setting is permitted. Select <b>TEMP.</b> icon, then click  enter setting, use    to adjust parameter, and then,click  to confirm or click <b>TEMP.</b> icon again to cancel. Long touch  for 3 seconds to switch C/F.



Following Description below to Use Cooking Function



<p>HOW TO BROIL</p>		<p>Touch this key, then touch  , next touch  , use    adjust time, then touch  , next touch  , use  and touch    to adjust temp. Use  conform. Touch  oven start heat circle, max rate power 2200W, max temp. 500 degree F touch  again or alarm runout, broil is end.</p>
<p>HOW TO BAKE</p>		<p>Touch this key, then touch  , next touch  , use    adjust time, then touch  , next touch  , use  and touch    to adjust temp. Use  conform. Touch  oven start heat circle, max rate power 2000W, max temp. 500 degree F touch  again or alarm runout, bake is end.</p>
<p>HOW TO BROIL WITH COVN.</p>		<p>Touch this key, then touch  , next touch  , use    adjust time, then touch  ,</p>



		<p>next touch  , use  and touch   </p> <p>to adjust temp. Use  conform. Touch  oven</p> <p>start heat circle, max rate power 3500W, max temp. 500 degree F touch  again or alarm runout, heat is end.</p>
<p>HOW TO BAKE WITH COV.N.</p>		<p>Touch this key, then touch  , next touch  ,</p> <p>use    adjust time, then touch  ,</p> <p>next touch  , use  and touch   </p> <p>to adjust temp. Use  conform. Touch  oven</p> <p>start heat circle, max rate power 3300W, max temp. 500 degree F touch  again or alarm runout, heat is end.</p>
<p>HOW TO AIRFRY</p>		<p>Touch this key, then touch  , next touch  ,</p> <p>use    adjust time, then touch  ,</p> <p>next touch  , use  and touch   </p> <p>to adjust temp. Use  conform. Touch  oven</p> <p>start heat circle, max rate power 3500W, max temp.</p>







		<p>500 degree F touch  again or alarm runout, heat is end.</p>
--	--	---

<p>HOW TO KEEPWARM</p>	 <p>KEEPWARM</p>	<p>Select <b>KEEPWARM</b> icon, then you can:</p> <p>→ Long touch  for 3 seconds to switch keepwarm function ON/OFF status. When the indicator of the button is ON, the keepwarm function is activated.</p> <p>* In <b>KEEPWARM</b> model, the oven automatically keeps warm for 8 hours after cooking.</p>
----------------------------	---	--



<p>HOW TO PREHEAT</p>	 <p>PREHEAT</p>	<p>Select <b>PREHEAT</b> icon, then you can:</p> <p>→ setting parameter, you need to </p> <p>→ click , oven start heat circle until <b>ALARM</b> run out to end.</p>
---------------------------	--	--

<p>LOCK MODE</p>		<p>Long touch  +  for 3 seconds, the 'L' will show on display. the control panel will be locked.</p> <p>Repeat the operation again, the control panel will be unlocked.</p>
------------------	--	---

SABBATH MODE		<p>Long touch  +  for 5 seconds, the oven will switch sabbath mode. In this mode ,the oven will keep silent and the lights turn dim. Only BAKE function can be used in this mode.</p>
--------------	--	---

In Cooking Status,		
1.		<p>If you want to change cooking mode, click  to pause, then choose another cooking mode, setting parameters and click  to start running again.</p>
2.	<p> Or  then click  to enter setting.</p>	
3.		<p>If you want to cancel cooking, click  first and then click  to end cooking.</p>

Following Description is how to Use Oven Light and Use Roses.  
Both function can be used at the same time.

LIGHT TURN ON/OFF	 LIGHT	Touch this icon, oven light turns on/off
ROSES. TURN ON/OFF	 ROSESI.	<p>Touch this icon, rotate motor turns on/off Note: When cooking function is finish, [ROSESI.] is off automatically.</p>

# Operate for Mechanical Control

## Control Panel of Model LB-ERK24RC-B and LB-ERK24RC-W

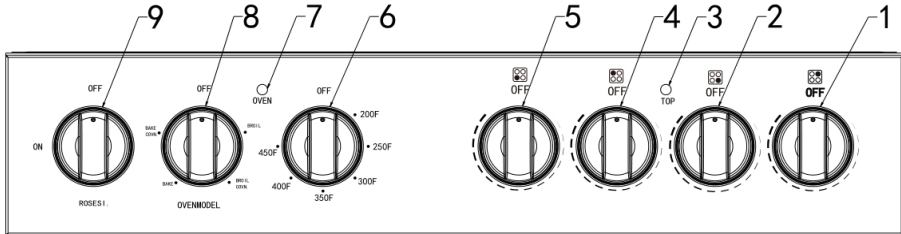

Cooktop Control		Oven Control	
1	Rear right element control knob	6	Oven temperature setting knob
2	Front right element control knob	7	Left oven indicator
3	Right element indicator	8	Oven mode knob
4	Rear left element control knob	9	Rotisserie knob
5	Front left element control knob		

Electric Oven Mode Setting		
	Bake+COVN	Lower heating element and hot Convection fan element are used
	Broil+COVN.	Upper heating element and hot Convection fan element are used
	Bake	Lower heating element is used
	Broil	Upper heating element is used

### Electric Oven Temperature Setting

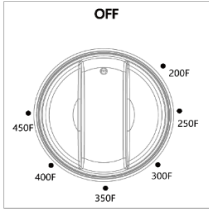

Number printed on the knob Temperature in °F	Corresponding temperature in °C
200	93
250	121
300	149
350	177
400	204
450	232

### Oven Thermostat

The numbers printed on the control panel indicate the oven temperature setting value (°F). To regulate the temperature, rotate the knob to select a temperature value.

The position **BROIL** serves only to turn on the broil burner.

**NOTE:** When the range is not being used, turn the knobs to their **OFF** positions.

**IMPORTANT:** The oven/broil shall be used always with the door closed. Always use suitable protective gloves when inserting/removing the broiler pan, shelves, pans and other cooking utensils from the oven.



# Care & Maintenance

## General Information

**CAUTION:** Before any operation of cleaning and maintenance disconnect the appliance from the electrical supply.

- It is advisable to clean when the appliance is cold, especially for cleaning the enameled parts.
- Avoid leaving alkaline or acidic substances (lemon juice, vinegar, etc.) on the surfaces.
- Avoid using cleaning products with a chlorine or acidic base.
- The oven must always be cleaned after every use, using clean and soft cloth soaked in water and neutral detergent and wipe it dry carefully.

## WARNING



### Electric Shock Hazard

Plug into a grounded 3-prong outlet.

Do not remove grounding prong.

Do not use an adapter.

Failure to follow these instructions can result in fire, electric shock or even death.

## Enameled Parts

All the enameled parts must be cleaned with a sponge and soapy water only or other nonabrasive detergent.

Dry preferably with a chamois leather.

If acid substances such as lemon juice, tomato conserve, vinegar etc. are left on the enamel for a long-time enameled parts can get etched and opaque.

## Stainless Steel Parts

Stainless steel parts must be rinsed with water and dried with a soft and clean cloth or with a chamois leather.

For difficult dirt, use a specific non-abrasive detergent available commercially or a little hot vinegar.

**NOTE:** Please clean and wipe the stainless-steel parts along their grain direction. Regular use could cause discoloring around the burners, because of the high flame temperature.

## Inside of Oven

The oven interior must be cleaned regularly. With the oven warm, wipe the inside walls with a clean and soft cloth soaked in very hot soapy water or another suitable product.

## Oven Shelf Installation and Removal

1. Open the electric oven door.
2. Insert the oven shelf to a proper cooking level.
3. Close the oven door.
4. To remove the shelf, please repeat above three steps in the reverse order.

**NOTE:** The shelf is provided with a security block to prevent accidental extraction.

Pay attention to insert the shelves correctly.

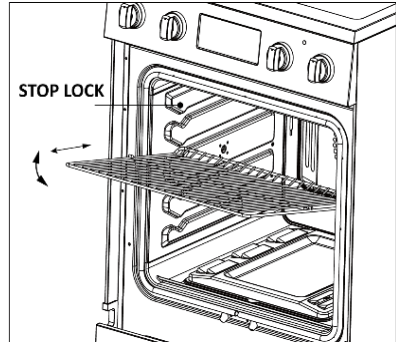

## Removable Storage Drawer

1. Lift the left small hook upward, at the same time, push the right small hook downward.

2. Pull the drawer out.

3. To replace the drawer, align the drawer with the rails and push inward.

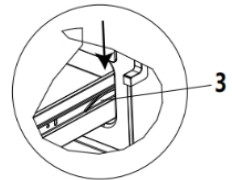
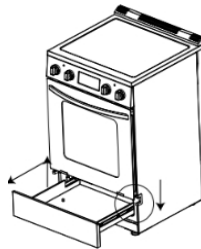

**Note: Do not store flammable material in oven or in the bottom drawer.**

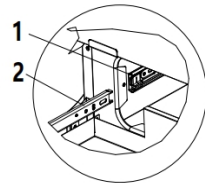
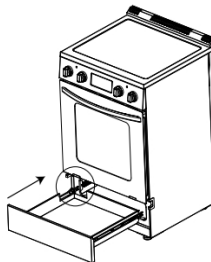

the

## Removing the Oven Door

To facilitate oven cleaning, it is possible to remove the door. Please follow the instructions carefully. The oven door can easily be removed as follows:

- Open the door to the full extent

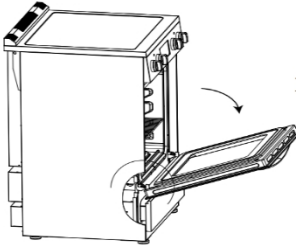

- Then turn the hinge as the picture shown.

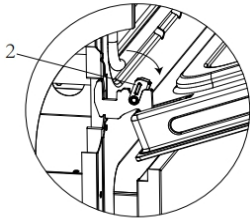

- Hold the door as shown

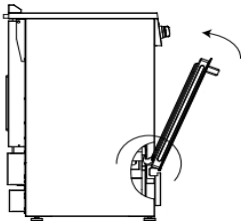

- Gently close the door and withdraw the hinge pins from their location

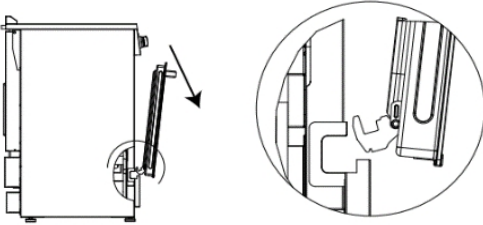
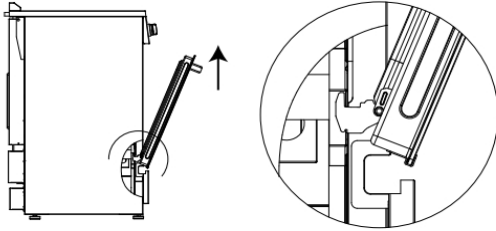

- To replace the door, repeat the above steps in reverse order.

## Cleaning Your Range

- Disconnect the A/C from the main power box or designated circuit breaker, turn off the range, make sure all surface units are off and cool before removing anything, then remove all items including shelves and rack.
- Wash the inside surfaces with a warm water and baking soda solution. The solution should be about 2 tablespoons of baking soda to a quart of water.
- Wash the shelves and rack with a mild detergent solution.
- The outside of the range should be cleaned with mild detergent and warm water.
- Wring excess water out of the sponge or cloth when cleaning area of the controls, or any electrical parts.
- Wash the outside cabinet with warm water and mild liquid detergent. Rinse well and wipe dry with a clean, soft cloth.
- Do not use steel wool or steel brush on the cook top.

## Replacing the Oven Light

Before any maintenance is started involving electrical parts of the appliance, it must be disconnected from the power supply.

- Let the oven cavity and broil burner cool down.
- Switch off the electric supply.
- Remove the protective cover.
- Unscrew and replace the bulb with a new one suitable for high temperature (300°C ~ 570°C) having the same specifications: 120V 60Hz, 25W, G9.
- Replace the protective cover.
- **NOTE:** Oven bulb replacement is not covered by your guarantee.

# Trouble shooting

Problem	Possible Cause
Surface units will not maintain a rolling boil or frying rate is not fast enough	<ul style="list-style-type: none"> <li>● You must use pans that are completely flat.</li> <li>● Pan bottoms should closely match the diameter of the surface unit selected.</li> <li>● The control knob turned to very low setting.</li> </ul>
Surface units do not operate	<ul style="list-style-type: none"> <li>● You have blown a household fuse or tripped a circuit breaker.</li> <li>● The surface units are not plugged in all the way.</li> <li>● You have not set the control knobs correctly.</li> </ul>
Control knobs will not turn	<ul style="list-style-type: none"> <li>● If it is a surface unit control knob, you are not pushing in before turning.</li> <li>● If it is oven control knob, you are trying to turn the knob in wrong direction.</li> </ul>
Oven light does not work	<ul style="list-style-type: none"> <li>● Light bulb is loose or defective.</li> <li>● Oven function knob was set to OFF.</li> <li>● Switch operating oven light is broken.</li> </ul>
Oven does not work	<ul style="list-style-type: none"> <li>● You have blown a household fuse or tripped a circuit breaker.</li> <li>● You have not set the control knobs correctly:               <ul style="list-style-type: none"> <li>– Oven function knob was set to OFF</li> <li>– Oven thermostat knob was set to OFF</li> </ul> </li> </ul>
Food does not broil properly	<ul style="list-style-type: none"> <li>● The oven control knob is not set at Broil.</li> <li>● Improper rack position being used.</li> <li>● Cookware is not suited for broiling.</li> <li>● Oven thermostat is defective.</li> </ul>
Food does not bake properly	<ul style="list-style-type: none"> <li>● The oven control knob is not set properly.</li> <li>● Rack position is incorrect.</li> <li>● Incorrect cookware or cookware of improper size is being used.</li> <li>● Oven thermostat is defective.</li> </ul>

Screen display "E1"	Cooling fan is defective, please contact supplier service. -----Range is forbidden to use.
Screen display "E2"	Oven temp. sensor is defective, please contact supplier service. --- Oven is forbidden to use, cooktop is permitted to use
Screen display "E3"	Oven temp. sensor and cooling fan is defective, please contact supplier service. --- Range is forbidden to use.
Screen display "E4"	External power supply over voltage. ---Nothing to do

# Warranty

Lanbo warrants for a period of 1 year from date of retail purchase by the original end-use purchaser, that this product, when delivered to you in new condition, in original packaging, from a Lanbo authorized reseller and used in normal conditions, is free from any defects in manufacturing, materials, and workmanship. In case of such defect, Lanbo shall replace or repair the product at no charge to you. This warranty does not cover: products where the original serial numbers have been removed, altered or cannot readily be determined; damage or loss caused by accident, misuse, abuse, neglect, product modification, failure to follow instructions in instruction manual, commercial or industrial use; damage or loss caused to the decorative surface of product; to any data, software or information; and normal wear and tear. This warranty only protects the original end-user (“you”) and is not transferable; any attempt to transfer this warranty shall make it immediately void. This warranty is only valid in the country of purchase.

This warranty and remedies set forth above are exclusive and in lieu of all other warranties, remedies, and conditions, whether oral or written, expressed or implied. Lanbo specifically disclaims any and all implied warranties, including, without limitation, warranties of merchantability and fitness for a particular purpose. If Lanbo cannot lawfully disclaim implied warranties under this limited warranty, all such warranties, including warranties of merchantability and fitness for a particular purpose are limited in duration to the duration of this warranty. No Lanbo reseller, agent, or employee is authorized to make any modification, extension, or addition to this warranty.

Lanbo is not responsible for direct, indirect, special, incidental, or consequential damages resulting from any breach of warranty or condition, or under any other legal theory, including but not limited to lost profits, downtime, goodwill, damage to or replacement of any equipment or property, any costs of recovering, reprogramming, or reproducing any program or data stored in or used with Lanbo products. Lanbo’s total liability is limited to the repair or replacement of this product pursuant to the terms of this warranty. Some states do not allow the exclusion or limitation of incidental or consequential damages or exclusions or limitations on the duration of implied warranties or conditions, so the above limitations or exclusions may not apply to you. This warranty gives you specific legal rights, and you may also have other rights that vary by state or (where applicable in the countries where Lanbo has non-US/Canadian authorized dealers) country. No action or claim to enforce this warranty shall be commenced after the expiration of the warranty period.



Keep your receipt, delivery slip, or other appropriate payment record to establish the warranty period. Service under this warranty must be obtained by contacting Lanbo at [service@lanboappliances.com](mailto:service@lanboappliances.com).

Product features or specifications as described or illustrated are subject to change without notice.

