

LANBOPRO

USER MANUAL

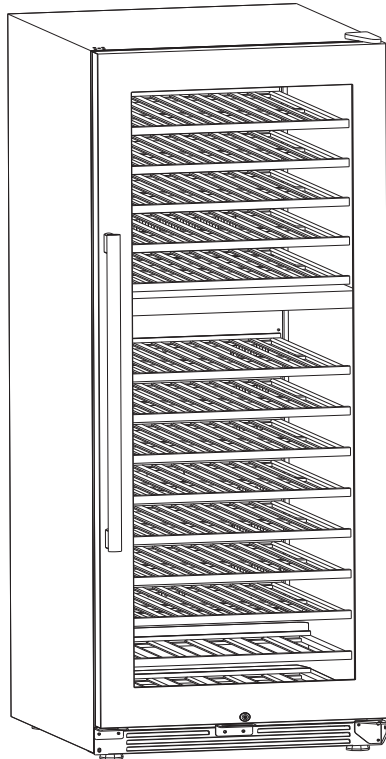

FOR MODEL:

LP54D/LP66D/LP168D/LP328D

LP54BC/LP66B

LP168S/LP328S

LP168T

Dear User,

Congratulations to you to get a new appliance and also thank you for purchasing from us.

Important Tips for Product Use.

BEFORE USE:

1. After unpacking and inspecting your new Lanbopro appliance, allow to sit and stabilize for 24 hours before connecting to a power source. This will reduce the possibility of a malfunction in the cooling system from handling during transportation.
2. Set temperature for select wines:
 - a. Merlot, Shiraz and Cabernet Sauvignon – Temp. Range 64-66°F
 - b. Chardonnay and Chablis – Temp. Range 48-52°F
 - c. Pinot Noir – Temp Range 60-64°F
 - d. Dessert Wines, Sparkling wine or Champagne - Temp 40°F
 - e. Pinot Grigio and Sauvignon Blanc – Temp Range 45-48°F

USAGE:

1. Doors must be closed properly at all times. Open door only when necessary in order to maintain optimum cabinet temperature and environment to preserve integrity of wine.
2. Place bottles on racks and avoid unnecessary movement until you are ready to enjoy your favorite bottle of wine. Maintaining minimal movement and vibration is essential in allowing wines to age to their fullest potential for maximum flavor.

PRODUCT REGISTRATION/WARRANTY:

LANBOPRO appliances offers a 1 year parts and labor warranty, along with a 3 year warranty on the compressor. Register your product on official website www.lanboappliances.com for an extended 12 month warranty and priority customer service support.

CUSTOMER SERVICE:

For assistance or questions regarding your product, please contact our customer service team at pro@lanboappliances.com .

Thanks for all your trust and support!

LANBO INTERNATIONAL INC.

Website:www.lanboappliances.com

Email:pro@lanboappliances.com

Catalogue

Important Safety Notes-----	4
Structures -----	6
Installation -----	14
Operation Instruction -----	17
Care and Maintenance -----	30
Troubleshooting -----	32
Data Parameters -----	33
Warranty Information -----	35

1. Important Safety Notes

⚡Warnings⚡

To reduce the risk of fire, electrical shock, or injury when using your appliance, follow these basic precautions:

- Carefully read all instructions before operating appliance.
- Keep children away from the wine cooler. Never allow children to operate, play with, or crawl inside the appliance.
- Never clean appliance parts with flammable fluids. Fumes can create a fire hazard or explosion.
- While wine cooler stops working, please call our after-sell service department or other related technicians to check and repair. Never do it by yourself in case of accident.
- If power cord becomes worn or damaged, contact a certified repair technician to replace the faulty power cord. Avoid injury, Do Not attempt to replace power cord by yourself.
- Make sure to unplug cord before cleaning, moving or repairing. Never unplug the cooler by pulling the electrical cord as this may damage it. Grip the plug firmly and pull straight out.
- Keep ventilation openings in the appliance enclosure clear of obstruction.
- Do not use mechanical devices or other means to accelerate the defrosting process other than those recommended by the manufacturer.
- Do not damage the refrigerant circuit.
- Do not use electrical appliances inside the food storage compartments of the appliance unless they are of the type recommended by the manufacturer.

-Save these instructions-

⚡Notes⚡

- In order to avoid damage to door seal, make sure the door is completely opened when removing the adjustable shelves.
- Place the cooler close to a direct power source or outlet.

- Once wines have been stored inside the cooler, avoid moving.
- Make sure the cooler placed in proper place in order to avoid that the compressor in the back could be easily touched.
- Do not power on the wine cooler repeatedly. Power on in 5 minute intervals.
- Before you throw away your old wine cooler: Take off the door. Leave the shelves in original place so that children may not easily climb inside.
- This appliance uses R600a refrigerant. Keep all flammable and explosive articles away from appliance to avoid fire or explosion.
- Under supervision or guidance, this appliance may be operated by children ages 8 years and above, or any persons with reduced physical, sensory or mental capabilities, provided proper operating and safety instructions have been administered.
- Do not allow children to play with appliance. Cleaning and maintenance shall not be performed by children without adult supervision.
- If the supply cord is damaged, it must be replaced by the manufacturer, its service agent or similarly qualified persons in order to avoid a hazard.
- Please keep this user manual for future reference, if you misplace or lose the user manual, please contact us at pro@lanboappliances.com
- This appliance is intended to be used in household and similar applications such as:
 - **Residential:** houses, apartments, townhomes, condos
 - **Work Environment:** kitchen areas, lunch rooms, cafeterias, offices other working environments;
 - **Hospitality:** hotels, motels, bed and breakfast
 - **Commercial:** restaurants, catering and similar applications
- Appearance and structure of the product may be different from the manual, however, this does not affect the normal use of the product.

2. Structures

1. LP66B structure diagram:

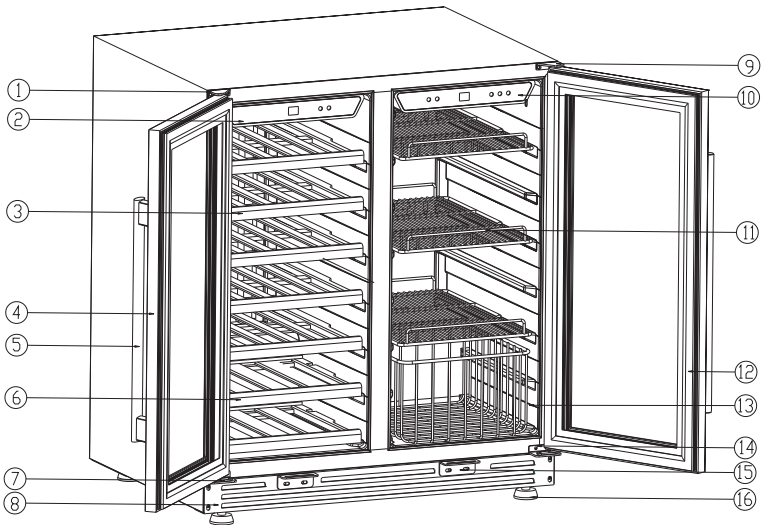

- (1) Left upper hinge (2) Left control panel (3) Full wooden shelf trimmed with stainless steel (4) Glass door with lock (5) Handle (6) Half wooden shelf trimmed with stainless steel (7) Left lower hinge (8) The front vent (9) Right upper hinge (10) Right control panel (11) Wire shelf (12) Door gasket (13) Wire basket (14) Right lower hinge (15) Lock hook (16) Adjustable feet

6.LP66D structure diagram:

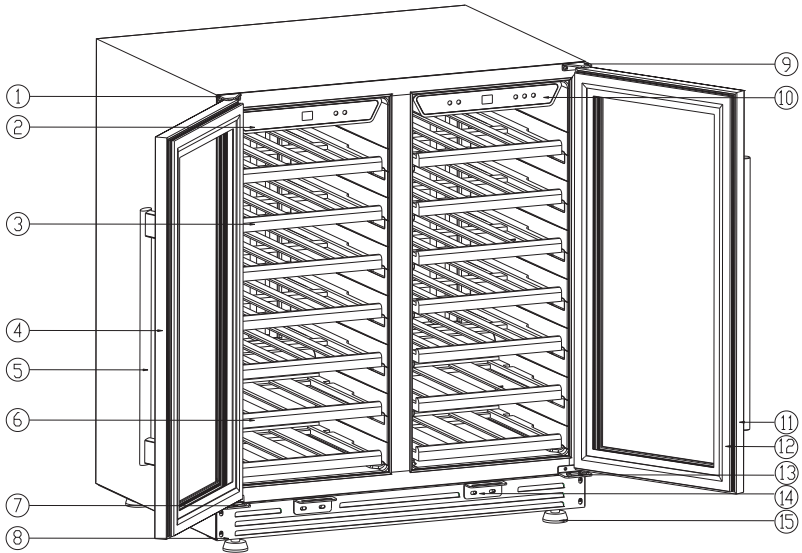

(1) Left upper hinge (2) Left control panel (3) Full wooden shelf trimmed with stainless steel (4) Glass door with lock (5) Handle (6) Half wooden shelf trimmed with stainless steel (7) Left lower hinge (8) The front vent (9) Right upper hinge (10) Right control panel (11) Right door (12) Door gasket (13) Right lower hinge (14) Lock hook (15) Adjustable feet

5. LP54BC structure diagram:

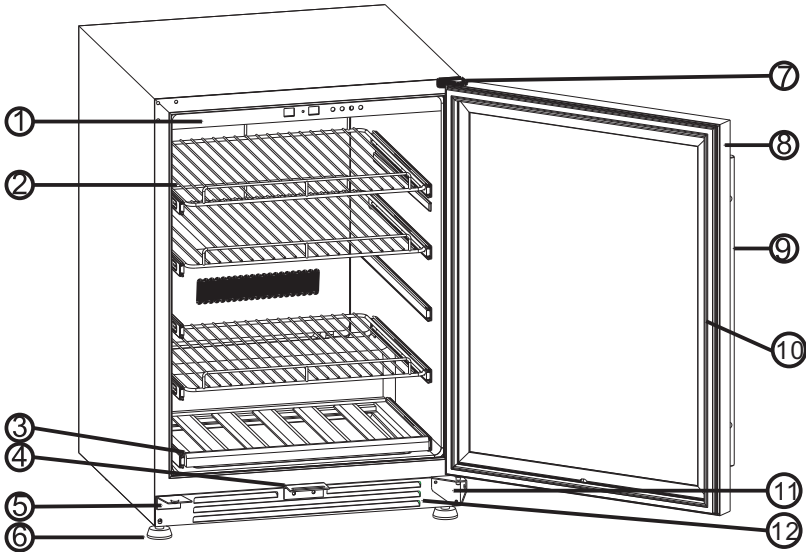

- (1) Control panel (2) Wire shelf (3) Half wooden shelf trimmed with stainless steel (4) Lock hook (5) Prevent fall device of the door (6) Adjustable feet (7) Upper hinge (8) Glass door with lock (9) Handle (10) Door gasket (11) Lower hinge (12) The front vent

2. LP54D/LP168D structure diagram:

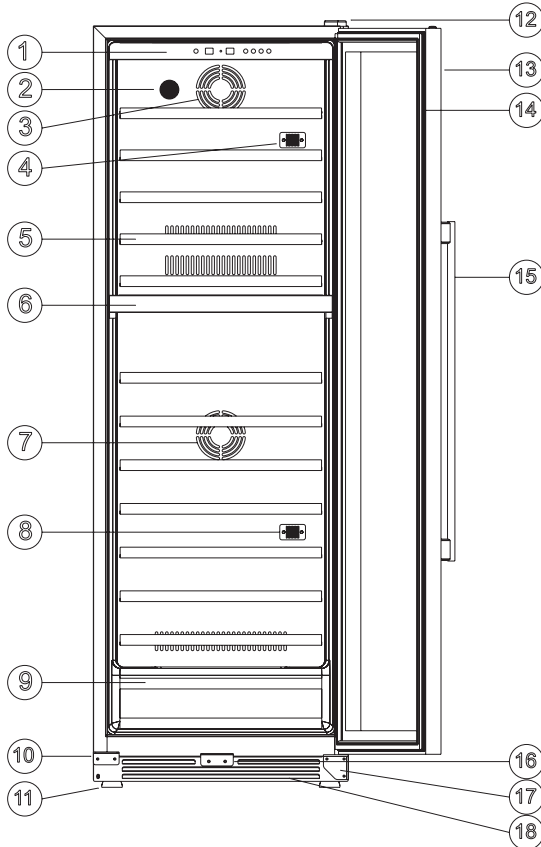

- (1) Control panel (2) Carbon filter (3) The fan of evaporator (4) The upper sensor (5) Full wooden shelf trimmed with stainless steel (6) Baffle plate (7) Heating fan (8) The lower sensor (9) Half wooden shelf trimmed with stainless steel (10) Prevent fall device of the door (11) Adjustable feet (12) Upper hinge (13) Glass door with lock (14) Door gasket (15) Handle (16) Lock hook (17) Lower hinge (18) The front vent

1.LP168S structure diagram:

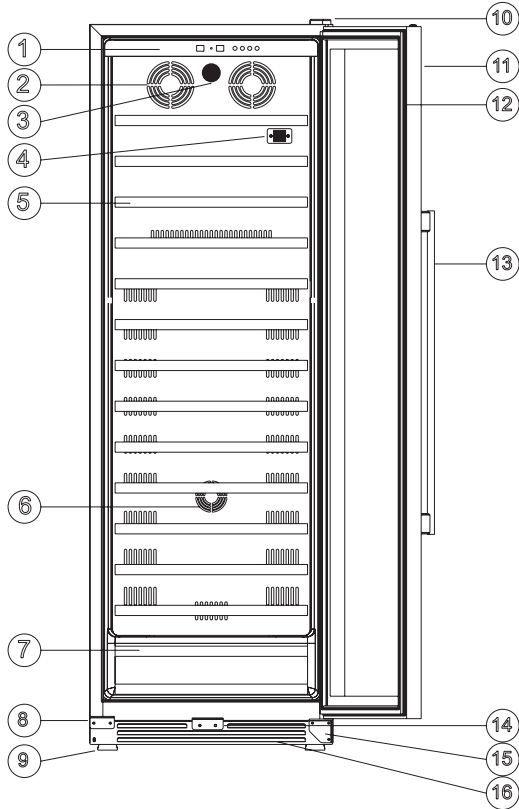

- (1) Control panel (2) The fan of evaporator (3) Carbon filter (4) Sensor
 (5) Full wooden shelf trimmed with stainless steel (6) Heating fan (7)
 Half wooden shelf trimmed with stainless steel (8) Prevent fall device
 of the door (9) Adjustable feet (10) Upper hinge (11) Glass door with
 lock (12) Door gasket (13) Handle (14) Lock hook (15) Lower hinge
 (16) The front vent

3. LP168T structure diagram:

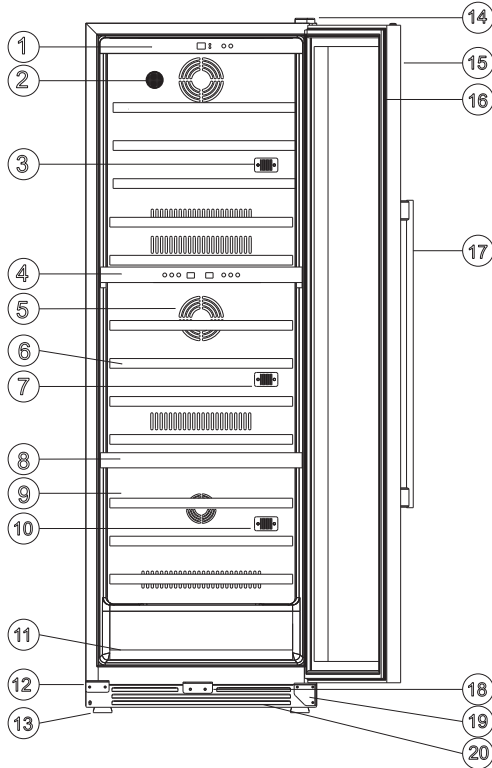

- (1) Upper control panel (2) Carbon filter (3) The upper sensor (4) Middle control panel (5) Middle fan (6) Full wooden shelf trimmed with stainless steel (7) The middle sensor (8) Baffle plate (9) The back air-duct board (10) The lower sensor (11) Half wooden shelf trimmed with stainless steel (12) Prevent fall device of the door (13) Adjustable feet (14) Upper hinge (15) Glass door with lock (16) Door gasket (17) Handle (18) Lock hook (19) Lower hinge (20) The front vent

8. LP328S structure diagram:

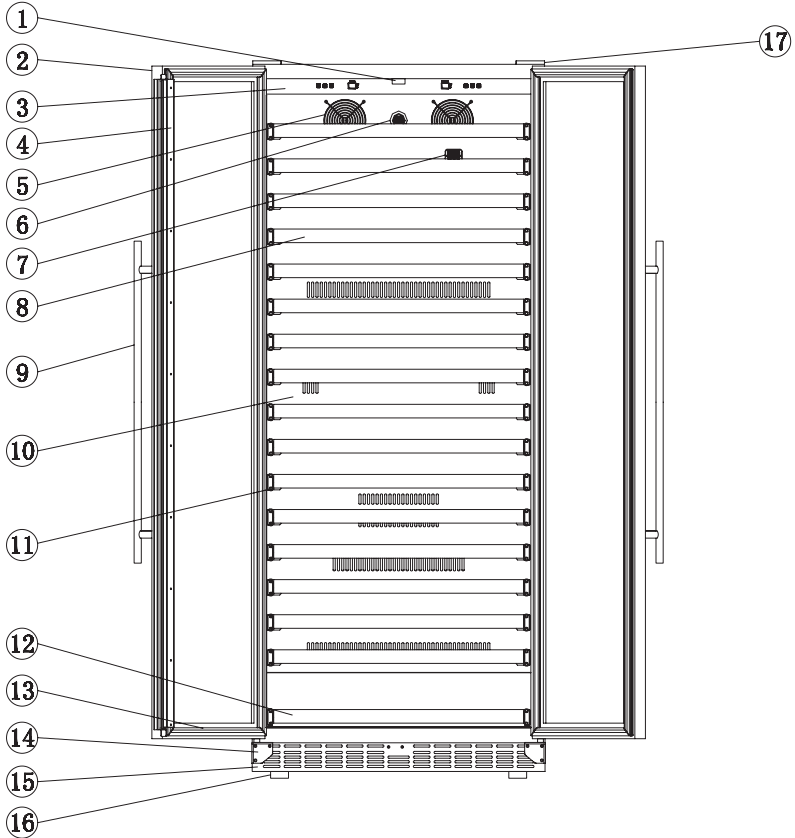

- (1)Door lock device (2)Glass door (3)Control panel (4)Middle crosser (5)The fan of evaporator (6) Carbon filter (7) Sensor (8)Full wooden shelf (9)Handle (10)Air-duct board (11)The rolling guide (12)Half wooden shelf (13) Door gasket (14) Prevent fall device of the door (15)The front vent (16)Adjustable feet (17)Upper hinge

7.LP328D structure diagram:

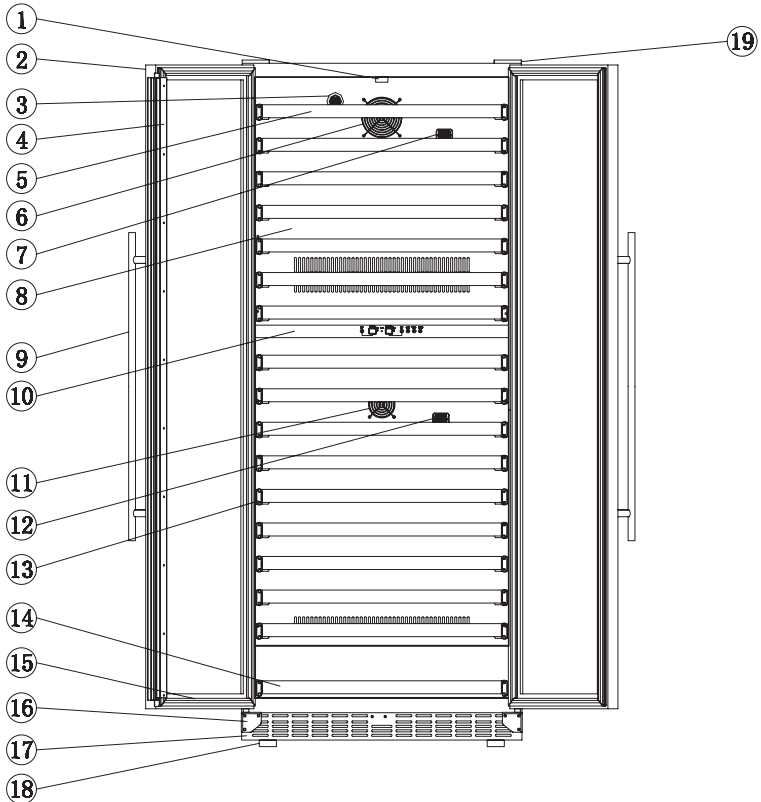

- (1)Door lock device (2)Glass door (3) Carbon filter (4)Middle crosser (5) Full wooden shelf
 (6)The fan of evaporator (7) The upper sensor (8)Air-duct board (9)Handle
 (10) Control panel (11) Heating fan (12)The lower sensor (13)The rolling guide
 (14)Half wooden shelf (15)Door gasket (16) Prevent fall device of the door
 (17) The front vent (18) Adjustable feet (19) Upper hinge

3.Installation

➤ Before Using Your Wine Cooler / Beverage Cooler

- Remove the exterior and interior packing.
- Before connecting the wine cooler / beverage cooler to the power source, let it stand upright for approximately 24 hours. This will reduce the possibility of a malfunction in the cooling system from handling during transportation.
- Clean the interior surface with lukewarm water with a soft cloth.
- The cooler is specially designed for wine storage, please do not put in other goods.

➤ Installation:

- The cooler should be placed independently so as to make sure good heat dissipation. The back of the cooler should be away from the wall 10cm at minimum.
- Place your wine cooler / beverage cooler on a floor that is strong enough to support it when it is fully loaded. To level your wine cooler, adjust the front leveling leg at the bottom of the wine cooler.
- Locate the wine cooler / beverage cooler away from direct sunlight and sources of heat (stove, heater, radiator, etc.). Direct sunlight may affect the acrylic coating and heat sources may increase electrical consumption. Extreme cold ambient temperatures may also cause the unit not to perform properly.
- Avoid locating the unit in moist areas.
- Plug in the proper power socket. Make sure that the shape and voltage of the socket is consistent with the nameplate on the back of the cooler.

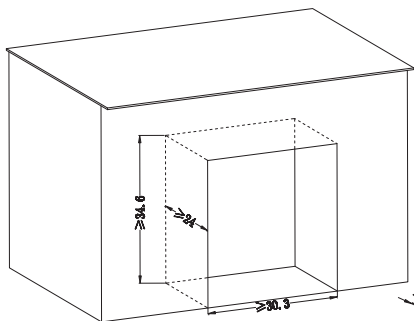

Unit: inch

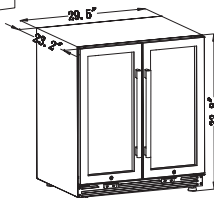

LP66B/LP66D

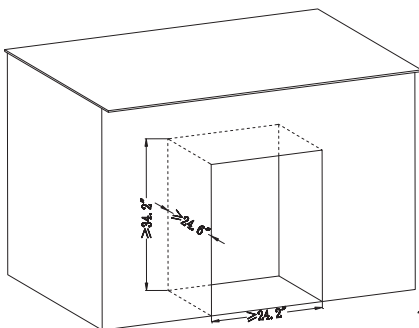

Unit: inch

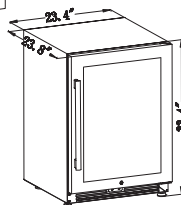

LP54BC/LP54D

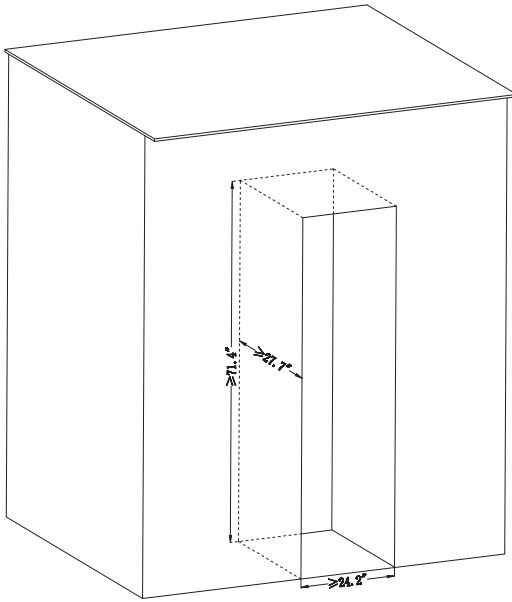

Unit: inch

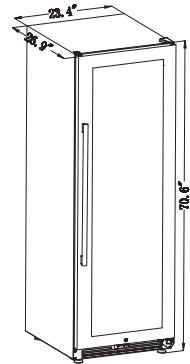

LP168S/LP168D/
LP168T

4. Operation Instruction

4.1 Control Panel Below (LP168S/LP54BC):

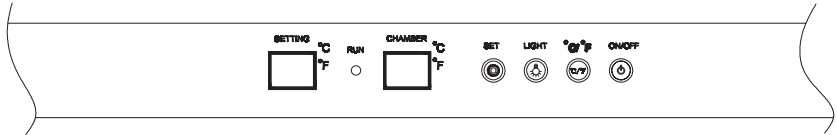

○ Display Windows

- **RUN Light**: Indicator light of compressor working. While the compressor operating, the red light is on. While it stops operating, the red light is off.
- **SETTING**: Display of the temperature you set. The range of temperature setting is 0°C~37°C or 32°F~99°F.
- **CHAMBER**: Display of the actual temperature inside the cabinet; The range is 0°C~37°C or 32°F~99°F.
- **°C/°F Light**: When the °C light is on, it indicates Celsius temperature; When the °F light is on, it indicates Fahrenheit temperature.

○ Button Operation

- **SET Button**: Temperature setting button; Once you press the button, the temperature increased 1°C or 1°F. Detail temperature setting range as following:
LP168S is between:5°C~18°C or 41°F~64°F;
LP54BC is between:1°C~18°C or 34°F~64°F;
- **LIGHT Button**: Cabinet light control button; Note: Once the light is turned on, it will automatically off after 10 minutes all out of protecting the wines inside.
- **°C/°F Button**: Celsius and Fahrenheit conversion button;
- **ON/OFF Button**: Power on and off button; Press the button for 3 seconds, it starts; press it 3 seconds again, it stops.

4.2 Control Panel Below (Only for model LP328S):

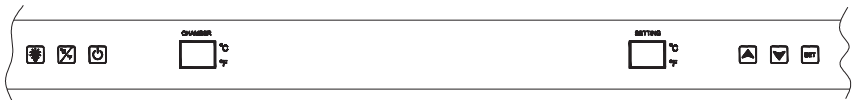

○ Display Windows

- **SETTING**: Display of the temperature you set. The range of temperature setting is 0°C~37°C or 32°F~99°F.
- **CHAMBER**: Display of the actual temperature inside the cabinet; The range is 0°C~37°C or 32°F~99°F.
- **°C/°F Light**: When the °C light is on, it indicates Celsius temperature; When the °F light is on, it indicates Fahrenheit temperature.

○ Button Operation

- **▲ ▼ Button**: Temperature setting button; Once you press the button, the temperature increased 1°C or 1°F. Detail temperature setting range as following:
For **LP328S** is between: 8°C~18°C or 46°F~64°F.
- **LIGHT Button**: Cabinet light control button; Note: Once the light is turned on, it will automatically off after 10 minutes all out of protecting the wines inside.
- **°C/°F Button**: Celsius and Fahrenheit conversion button;
- **⏻ Button**: Power on and off button; Press the button for 3 seconds, it starts; press it 3 seconds again, it stops.

4.3 Control Panel Below (LP66B/LP66D) :

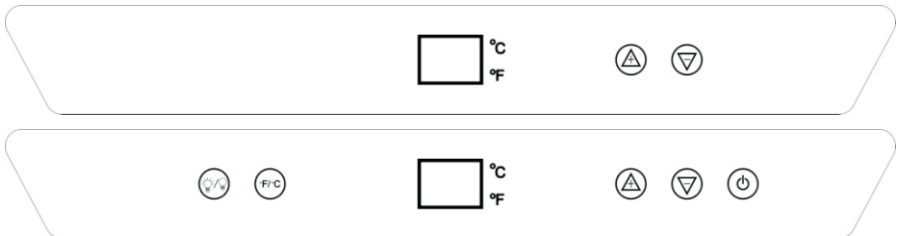

○ Display Windows

- CHAMBER** : Display of the setting and actual temperature inside the cabinet; The range is 0°C~37°C or 32°F~99°F.
- °C/°F Light** : When the °C light is on, it indicates Celsius temperature; When the °F light is on, it indicates Fahrenheit temperature.

○ Button Operation

- “+” “-” Button** : Temperature setting button; Once you press “+” button, the temperature increase 1°C or 1°F; if you want to decrease the temperature, press the “-” button, the temperature decreased 1°C or 1°F each time.

Detail temperature setting range as following:

For **LP66B** is between: 5°C~18°C or 41°F~64°F for the left zone, 4°C~10°C or 39°F~50°F for the right zone.

For **LP66D** is between: 5°C~18°C or 41°F~64°F both for the left and right zone.

- LIGHT Button** : Cabinet light control button; Note: Once the light is turned on, it will automatically off after 10 minutes all out of protecting the wines inside.
- °C/°F Button** : Celsius and Fahrenheit conversion button;
- ON/OFF Button** : Power on and off button; Press the button for 3 seconds, it starts; press it 3 seconds again, it stops.

4.4 Control Panel Below (only for model LP168T) :

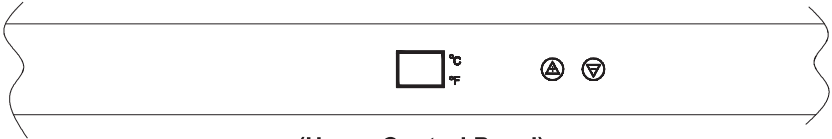

(Upper Control Panel)

○ **Display Windows**

•**CHAMBER:** Display of the actual temperature of the upper chamber. The range is 0°C~37°C or 32°F~99°F.

○ **Button Operation**

“+” “-” **Button:** Temperature setting button. Each time you press the button “+” button the temperature increased 1°C or 1°F. Or press “-” button the temperature decreased 1°C or 1°F; Setting range is between 5°C~18°C or 41°F~64°F of upper zone.

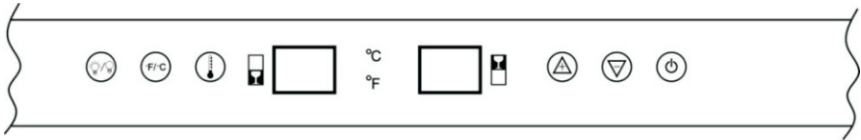

(Middle and Lower Control Panel)



○ **Display Windows**

• **MIDDLE CHAMBER:** Display of the actual temperature of the middle chamber. The range is 0°C~37°C or 32°F~99°F.

• **LOWER CHAMBER:** Display of the actual temperature of the lower chamber; The range is 0°C~37°C or 32°F~99°F.

•**°C/°F Light:** When the °C light is on, it indicates Celsius temperature; When the °F light is on, it indicates Fahrenheit temperature.

◎ Button Operation

- **“+” “-” Button:** Temperature setting button; If you need setting the temperature of middle chamber, press the  button one time, the screen of middle chamber will be flashing, then press “+” or “-” to set the temperature of middle chamber, setting range is between 5°C ~12°C or 41°F ~54°F . If you need setting the temperature of lower chamber, press the  button two times, the screen of lower chamber will be flashing, press “+” or “-” to set the temperature of lower chamber, setting range is between 12°C ~18°C or 54°F ~64°F.
- **LIGHT Button:** Cabinet light control button; Note: Once the light is turned on, it will automatically off after 10 minutes all out of protecting the wines inside.
- **ON/OFF Button:** Power on and off button; Press the button for 3 seconds, it starts; press it 3 seconds again, it stops.

4.5 Control Panel Below(LP54D/LP168D/LP328D) :

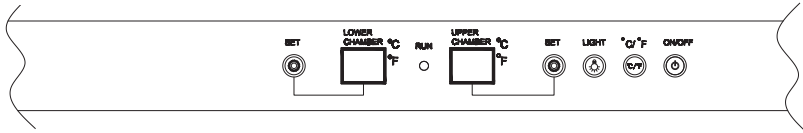

○ Display Windows

- **RUN Light**: Indicator light of compressor working. While the compressor operating, the red light is on. While it stops operating, the red light is off.
- **UPPER CHAMBER**: Display of the actual temperature of the upper chamber. The range is 0°C~37°C or 32°F~99°F.
- **LOWER CHAMBER**: Display of the actual temperature of the lower chamber; The range is 0°C~37°C or 32°F~99°F.
- **°C/°F Light**: When the °C light is on, it indicates Celsius temperature; When the °F light is on, it indicates Fahrenheit temperature.

○ Button Operation

- **SET Button**: Temperature setting button; Once you press the button, the temperature increased 1°C or 1°F. Detail temperature setting range as following:

For **LP54D/LP168D** is between:

5°C~12°C or 41°F~54°F for upper zone, 12°C~18°C or 54°F~64°F for lower zone;

For **LP328D** is between:

8°C~12°C or 46°F~54°F for upper zone, 12°C~18°C or 54°F~64°F for lower zone;

- **LIGHT Button**: Cabinet light control button; Note: Once the light is turned on, it will automatically off after 10 minutes all out of protecting the wines inside.
- **°C/°F Button**: Celsius and Fahrenheit conversion button;
- **ON/OFF Button**: Power on and off button; Press the button for 3 seconds, it starts; press it 3 seconds again, it stops.

Note: This series of wine coolers has its delay protection function. The compressor will start to work about 3 to 5 minutes after it is power connected or powered off. Please use the wine cooler under the T type of climate. The temperature inside the cabinet will fluctuate and influence the refrigerating effect if the surrounding temperature is too high or too cold.

○ **Shelf Change** LP66D,LP54D,LP168D,LP328D,LP168S,
LP168T,LP328S

Do as the following shows if needing to pull out or change the shelves;

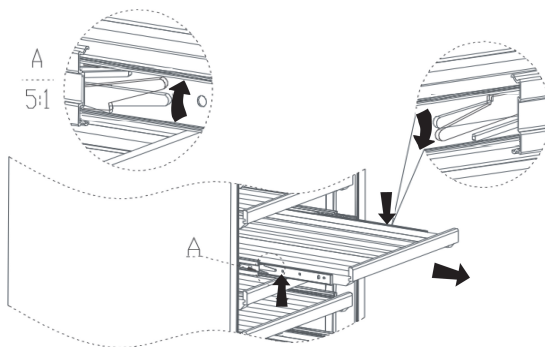

Firstly take out all the wines from the shelves and pull shelf out to the limit. Then press up the left limit of sliding rail and meanwhile press down the right one, pull the shelves out at this time. It could be easily pulled out if doing the three steps (Press up left limit, press down the right one and pulling out) at the same time.

○ **Shelf Change LP66B,LP54BC**

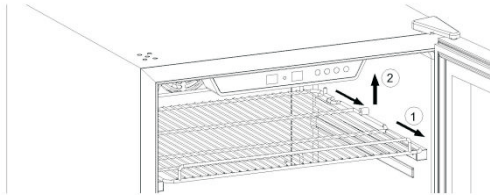

Pull out the wire shelf, make the cove position toward to the pillar at two sides of the cabinet, then lift up and pull out the wire shelf.

Placement and storage of wines several common layouts of wines:

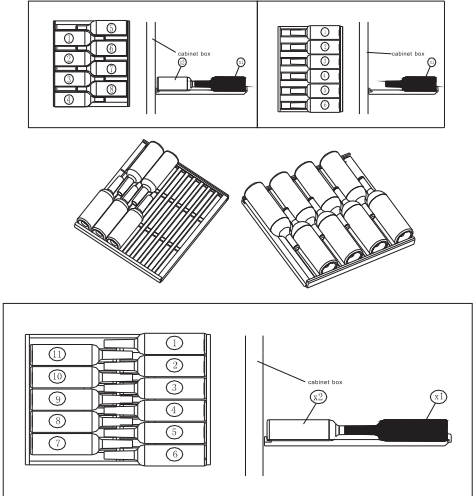

Shelf bottle layout:

LP54BC:

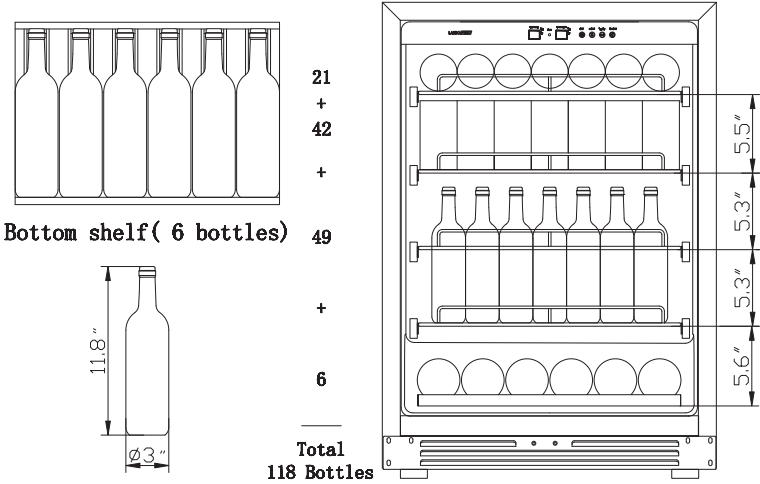

LP66B:

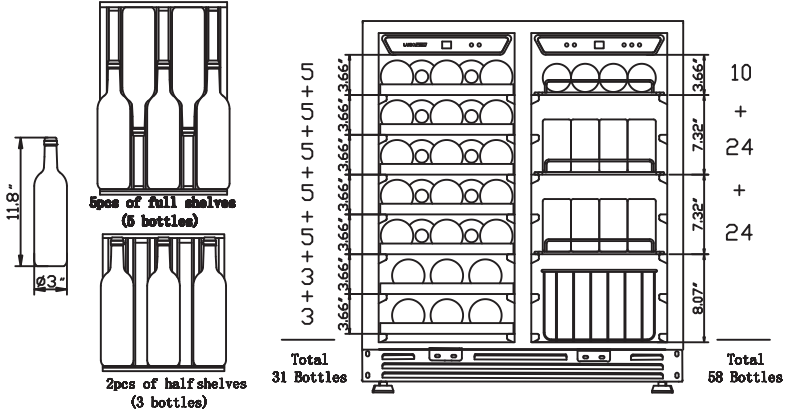

LP168S:

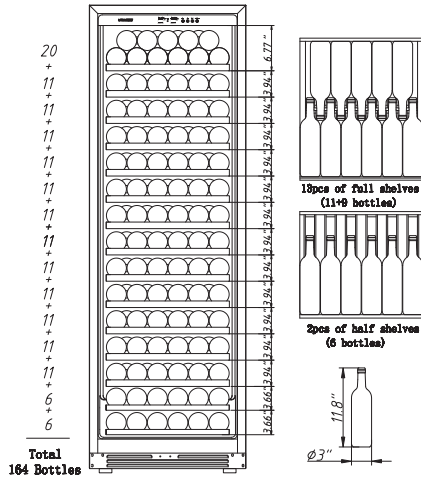

LP168D:

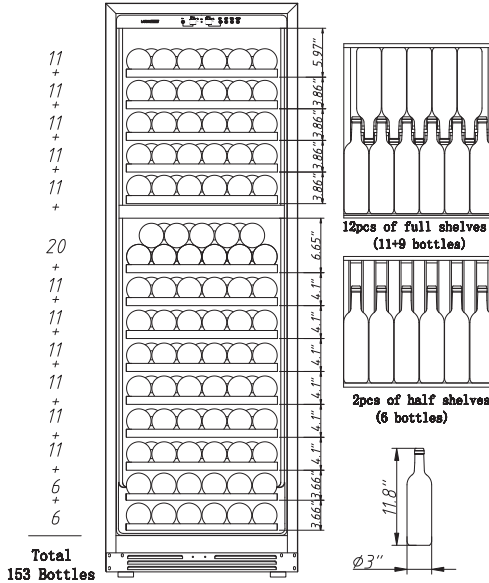

LP168T:

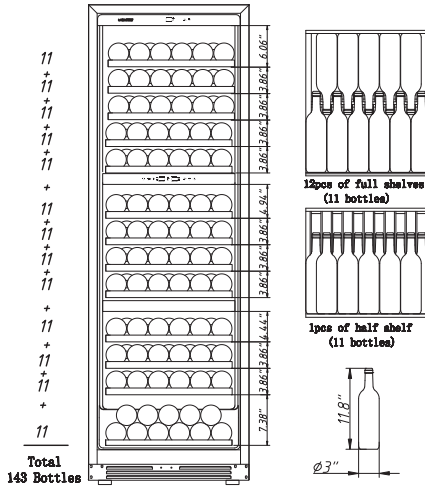

LP328D:

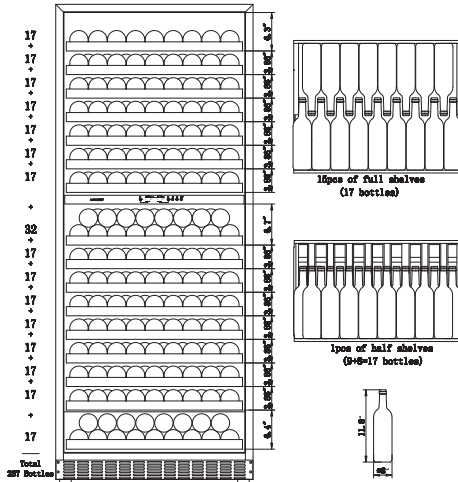

LP328S:

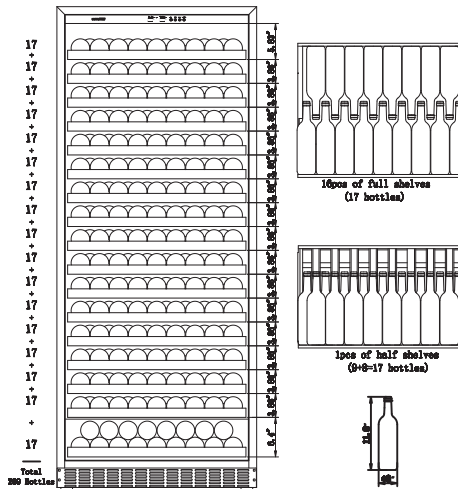

Your cabinet was designed to store a maximum number of bottles in total security.

The wines are kindly advised to layout equally.

The best temperature for red wines is 52-64°F ; For white wines is 43-54°F.

5. Care and Maintenance

Cleaning Your Wine Cooler

- Wash the inside surfaces with warm water and baking soda solution. The solution should be about 2 tablespoons of baking soda with a quart of water.
- Wash the shelves with a mild detergent solution.
- Turn off the power, unplug the appliance, and remove all items including shelves and rack.
- Wring excess water out of the sponge or cloth when cleaning area of the controls, or any electrical parts.
- Wash the outside cabinet with warm water and mild liquid detergent. Rinse well and wipe dry with a clean soft cloth.

➤ Power Failure

- Most power failures are corrected within a few hours and will not affect the temperature of your appliance if you minimize the number of times the door is opened. If the power is going to be off for a longer period of time, you need to take the proper steps to protect your contents.

➤ Vacancy time

- **Short vacancy:** Leave the wine cooler stopping working for around three weeks.
- **Long vacancy:** If the appliance will not be used for several months, remove all items and turn off the appliance. Clean and dry the interior thoroughly so as to restraint odors and mould. Leave the door open slightly all the time if necessary.

➤ **Moving Your Wine Cooler**

- Remove all items.
- Securely tape down all loose items (shelves) inside your appliance.
- Turn the adjustable leg up to the base to avoid damage.
- Make the door shut.
- Be sure the appliance stays secure in the upright position during transportation.

Also protect outside of appliance with a blanket, or similar item.

Energy saving Tips

- The Wine Cooler should be located in the coolest area of the room, away from heat producing appliances, and out of the direct sunlight

6. Troubleshooting

You can solve many common wine cooler problems easily, saving you the cost of a possible service call. Try the suggestions below to see if you can solve the problem before calling the service.

PROBLEM	POSSIBLE CAUSE	SOLUTION
Refrigerator does not operate	Not plugged in The appliance is turned OFF at the control panel The circuit breaker has tripped or a fuse has blown out	Press ON/OFF Check and make sure the power plug is well connected Ask an engineer for help
Refrigerator is not cold enough; can not cool down to the preset temp.	Compressor does not start	Ask an engineer for help / check the connection of the compressor
	Compressor self-protected and has stopped operating	The ambient temperature is too high (over 38C degree Celsius) The air venting is not smooth, check that the air duct is not blocked Fan operates slowly or is faulty and has stopped operating. The door is not closed completely, or the door opened too long The compressor, or its components are faulty
	Fans stop working or operate at low speed	Ask an engineer for help. Power the refrigerator ON and OFF. Check the fan and whether the voltage is normal. If the voltage is normal, then the fan should be damaged
	Evaporator ices up	Turn OFF the refrigerator for one hour and open the door. The ice on the evaporator will melt. Check the door seal for any air gaps.
	Door is not closed properly	Check the door lock, shelves, or other objects, make sure door is well closed. Check the rubber seal for any air gaps. Check the door hinges, make sure they are not loose
	Condenser is dusty	Wash and clean the condenser
	Cooling system faulty (Gas leakage or blockage)	Ask an engineer for help
Compressor starts and stops frequently	The door gasket does not seal properly.	Use low heat on a hair dryer to make the door seal take shape.
	The sensor connection is wrong.	Read the wiring diagram to make the correct connection of sensor
	The sensor is faulty.	Replace with a new sensor
	The door is opened too often.	Reduce the times / frequency of door openings.
The light does not work.	Not plugged in, or the light button is "OFF". Light itself faulty.	Check and make sure the light button is ON, or ask an engineer for help.
The Refrigerator seems to make too much noise.	The stand feet is not leveling, vibrations lead to noise	Adjust the stand feet and ensure they are level.
	Copper pipe hits other objects and makes noise	Gently adjust the position of the pipe.
	When the compressor shuts down or starts, it is normal for noise from the vibrations generated by the internal moving parts due to inertia.	Take no action
	A liquid plumbing noise may come from the flow of the refrigerators gases, which is normal. As each cycle ends, you may hear gurgling sounds	Take no action
The door will not close properly.	Door is blocked by the door lock, shelves, or other objects.	Remove the barrier

	Door sealing rubber is deformed	Repair or replace the rubber seal
	Door hinges are not loose.	Adjust and fasten the hinges.
Ice up	Outlet / suction outlet blockage	Remove the barrier
	Fans stop working or operate at low speed.	Ask an engineer for help. Power the refrigerator ON and OFF. Check the fan and the voltage. If the voltage is normal, the fan may be damaged.
	The door gasket does not seal properly; or door is opened too often	Use low heat on a hair dryer to make the door seal take shape.
	Gas leakage or cooling system blockage	Ask an engineer for help
External cabinet seems too hot	Ambient temperature is too high, or direct sunshine	Operating conditions need to be improved
	Front grill outlet / suction outlet blockage	Remove the barrier
	Fans stop working or low speed operating	Ask engineer for help, power on the refrigerator, check the fan whether the voltage is normal or not. If the voltage is normal, the fan should be damage
Water drop on glass door	Ambient humidity is high	Use a soft cloth to clean the water
	Door is opened too often	Reduce the times / frequency of door opening.
	The door gasket does not seal properly	Use low heat on a hair dryer to make the door seal take shape.

7. Data Parameters

MODEL NO.	LP54BC	LP54D	LP168S	LP328S	LP66D
VOLUME	5.79 CF (164 Liter)	5.44 CF (154 Liter)	15.89 CF (450 Liter)	26.84CF (760 Liter)	5.93 CF (168 Liter)
TYPE OF COOLING	compressor with air-circulated fan cooling	compressor with air-circulated fan cooling	compressor with air-circulated fan cooling	compressor with air-circulated fan cooling	compressor with air-circulated fan cooling
CLIMATE TYPE	N				
ELECTRICITY PROTECTION GRADE	I	I	I	I	I
NOMINAL VOLTAGE/FREQUE NCY	110-120V/60HZ				
RATED POWER(W)	100W / 1.3A	100W / 1.3A	140W / 1.9A	220W / 2.5A	90W/1.3A
AMBIENT TEMPERATURE	32 - 100 °F	32 - 100 °F	32 - 100 °F	32 - 100 °F	32 - 100 °F
TEMPERATURE RANGE	1°C~18°C or 34°F~64°F	5°C~12°C or 41°F~54°F 12°C~18°C or 54°F~64°F	5°C~18°C or 41°F~64°F	8°C~18°C or 46°F~64°F	5°C~18°C or 41°F~64°F for the left zone 5°C~18°C or 41°F~64°F for the right zone

NET WEIGHT	106 lbs (48 KGS)	117 lbs (53 KGS)	216 lbs (98 KGS)	309 lbs (140 KGS)	137 lbs (62 KGS)
PRODUCT DIMENSION	23.43"W x 23.62"D x 34.45"H	23.43"W x 23.62"D x 34.45"H	23.42"W x 26.77"D x 71.26"H	32.28"W x 29.33"D x 79.21"H	29.53"W x 23.62"D x 34.45"H

MODEL NO.	LP168D	LP328D	LP66B	LP168T	
VOLUME	15.89 CF (450 Liter)	26.84CF (760 Liter)	5.93 CF (168 Liter)	15.89 CF (450 Liter)	
TYPE OF COOLING	compressor with air-circulated fan cooling	compressor with air-circulated fan cooling	compressor with air-circulated fan cooling	compressor with air-circulated fan cooling	
CLIMATE TYPE	N				
ELECTRICITY PROTECTION GRADE	I	I	I	I	
NOMINAL VOLTAGE/FREQUENCY	110-120V/60HZ				
RATED POWER(W)	140W / 1.9A	220W / 2.5A	90W / 1.3A	140W / 1.9A	
AMBIENT TEMPERATURE	32 - 100 °F	32 - 100 °F	32 - 100 °F	32 - 100 °F	
TEMPERATURE RANGE	5°C~12°C or 41°F~54°F 12°C~18°C or 54°F~64°F	8°C~12°C or 46°F~54°F 12°C~18°C or 54°F~64°F	5°C~18°C or 41°F~64°F for the left zone 4°C~10°C or 39°F~50°F for the right zone	5°C~18°C or 41~64°F for the upper zone 5°C~12°C or 41°F~54°F for the middle zone 12°C~18°C or 54~64°F for the lower zone	
NET WEIGHT	220 lbs (100KGS)	320lbs (145KGS)	137 lbs (62 KGS)	220 lbs (100KGS)	
PRODUCT DIMENSION	23.42"W x 26.77"D x 71.26"H	32.28"W x 29.33"D x 79.21"H	29.53"W x 23.62"D x 34.45"H	23. 42"W x 26.77"D x 71.26"H	

Warranty Information

Please speak to your retailer before calling **Lanbo International Inc.** if you did not purchase your refrigerator directly from **LANBOPRO**.

Limited warranty - If your refrigerator is not operating properly, LANBOPRO reserves the right to repair or repair or replace the refrigerator. LANBOPRO may request the consumer to contact a local refrigeration company to service the refrigerator. All cost for labor and materials are covered for 12 month whole parts and compressor covered for 36 months warranty. If LANBOPRO deems the unit not repairable. LANBOPRO will use the value of your original order toward a replacement. For customer service, please contact **Lanbo International Inc.** By email: pro@lanboappliances.com

The limited warranty does not cover: Damage due to such things as accident, misuse, abuse, mishandling, neglect, unauthorized repair or any other cause beyond the control of the seller whether similar or dissimilar to the foregoing. Purchaser understands and acknowledges that the goods sold here are WINE / BEVERAGE COOLERS. Purchaser assumes all the risk of using these units, including risk of spoilage, humidity variations, temperature variations, leaks, fires, water damage, mold, mildew, dryness and similar perils that may occur.

SPECIAL NOTE:Warranty is only honored for the unit which is purchased and used in United States of America. And, if your product was purchased at any 3rd party retailer and not directly from LANBOPRO, we do not offer an extended warranty policy. You must contact the retailer of purchase directly. In the event your retailer does not over an extended warranty plan, we recommend you contact a third party warranty provider. However, regardless of point of purchase, all LANBOPRO coolers are backed by a **12 months** manufacturer's warranty from date of sale.

Prop. 65 Warning for California Residents



WARNING

Cancer and Reproductive Harm -
www.P65Warnings.ca.gov

