

# Cuisinart® INSTRUCTION BOOKLET

Recipe  
Booklet  
Reverse Side



**Cuisinart® Griddler®**

**GR-4NP1**

For your safety and continued enjoyment of this product, always read the instruction book carefully before using.

E IB-8999A



---

## IMPORTANT SAFEGUARDS

1. **READ ALL INSTRUCTIONS.**
2. Do not touch hot surfaces; use handles or knobs.
3. To protect against fire, electric shock, and injury to persons, **DO NOT IMMERSE CORD OR PLUG** in water or other liquids.
4. Close supervision is necessary when any appliance is used by or near children.
5. Unplug from outlet when not in use and before cleaning. Allow to cool before putting on or taking off parts, and before cleaning appliance.
6. Do not operate any appliance with a damaged cord or plug, or after the appliance has malfunctioned or has been damaged in any manner. Return the appliance to the nearest Cuisinart® Repair Center for examination, repair or adjustment.
7. The use of accessory attachments not recommended by Cuisinart may result in fire, electrical shock, or risk of injury to persons.
8. Do not use outdoors.
9. Do not let power cord hang over edge of table or counter, or touch hot surfaces.
10. Do not place on or near hot gas or electric burner, or in a heated oven.
11. Unplug the unit when finished using.
12. Do not use appliance for other than intended use.
13. Extreme caution must be exercised when moving an appliance containing hot oil or other hot liquids.
14. To disconnect, turn Selector Dial to OFF setting, then remove plug from wall outlet.
15. **WARNING: TO REDUCE THE RISK OF FIRE OR ELECTRIC SHOCK, ONLY AUTHORIZED PERSONNEL SHOULD DO REPAIRS.**

## SAVE THESE INSTRUCTIONS FOR HOUSEHOLD USE ONLY

### SPECIAL CORD SET INSTRUCTIONS

A short power-supply cord is provided to reduce the risks resulting from becoming entangled in or tripping over a longer cord. Longer extension cords are available and may be used if care is exercised in their use.

If a long extension cord is used, the marked electrical rating of the extension cord should be at least as great as the electrical rating of the appliance, and the longer cord should be arranged so that it will not drape over the countertop or tabletop where it can be pulled on by children or animals, or tripped over.

### NOTICE

This appliance has a polarized plug (one blade is wider than the other) to reduce the risk of electric shock. This plug will fit in a polarized outlet only one way. If the plug does not fit fully in the outlet, reverse the plug. If it still does not fit, contact a qualified electrician. Do not modify the plug in any way.

### CONTENTS

|                                |   |
|--------------------------------|---|
| Important Safeguards.....      | 2 |
| Introduction.....              | 3 |
| Parts and Features .....       | 3 |
| Before the First Use.....      | 3 |
| The Griddler® Does it All..... | 3 |
| Assembly Instructions .....    | 5 |
| Operating Instructions .....   | 6 |
| User Maintenance.....          | 7 |
| Cleaning and Care .....        | 7 |
| Storage.....                   | 8 |
| Warranty.....                  | 8 |

## INTRODUCTION

Congratulations on your purchase of the Cuisinart® Griddler®. This product is actually five appliances in one. A hinged, floating cover and one set of removable and reversible cooking plates turn the Griddler® into a contact grill, panini press, full grill, full griddle, or half grill/half griddle. Dual temperature controls and indicator lights make this product easy to use. Dishwasher-safe plates, integrated drip tray and a cleaning/scraping tool make cleanup fast and easy.

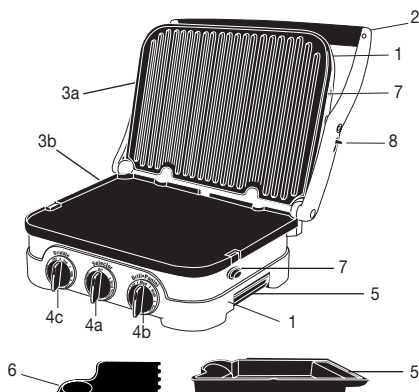

## PARTS AND FEATURES

- 1. Base and Cover**  
Solid construction with stainless steel self-adjusting cover
- 2. Panini-Style Handle**  
Sturdy cast-metal handle adjusts cover to accommodate thickness of food
- 3. Removable and Reversible Cooking Plates**  
Nonstick and dishwasher safe for easy cleanup
  - a. Grill Side:** Perfect for grilling steak, burgers, chicken and vegetables
  - b. Griddle Side:** Prepare flawless pancakes, eggs, bacon and seared scallops
- 4. Controls**  
Indicator lights signal Power On and Ready to Cook
  - a. Selector**  
Choose the Grill/Panini or Griddle function
  - b. Grill/Panini**  
Adjust temperature from “warm” to “sear”
  - c. Griddle**  
Adjust temperature from 200°F to 425°F
- 5. Drip Tray**  
Collects grease and removes from base for easy cleanup (dishwasher safe)
- 6. Cleaning/Scraping Tool**  
Helps clean grill and griddle plates after cooking
- 7. Plate Release Buttons**  
Push in to release and remove cooking plates

- 8. Hinge Release Lever**  
Allows the cover to extend back for cooking in the flat position

## BEFORE THE FIRST USE

Remove all packaging materials and any promotional labels or stickers from your grill. Be sure all parts (listed under **Parts and Features**) of your new appliance have been included before discarding any packaging materials. You may want to keep the box and packing materials for use at a later date.

Before using your Cuisinart® Griddler® for the first time, remove any dust from shipping by wiping the base, cover and controls with a damp cloth. Thoroughly clean cooking plates, drip tray and scraping tool. The plates, drip tray and cleaning tool are dishwasher safe. Refer to **Assembly Instructions** for plate removal.

## THE GRIDDLER® DOES IT ALL

The Griddler® is the ultimate kitchen appliance, offering you five separate cooking options. Simply flip the reversible cooking plates and adjust the hinge to use as a *contact grill*, *panini press*, *full grill*, *full griddle*, or *half grill/half griddle*. See **Assembly Instructions** and **Operating Instructions**.

---

### Contact Grill

Use the Griddler® as a Contact Grill to cook burgers, boneless pieces of meat and thin cuts of meat and vegetables.

The Contact Grill function works best when you want to cook something in a short amount of time or when you are looking for a healthy method of grilling. When cooked on the contact grill, food will cook quickly because you are grilling both sides of the food at the same time. The ribs on the grill side of the plates, combined with the grease spout at the rear of the plate, allow the grease to drip from the meat and drain off the plates.

When the Griddler® is used as a Contact Grill, the grill side of the plates is recommended. Rest the cover evenly on top of the food until it has reached the desired cooked temperature.

The Griddler® was designed with a unique handle and hinge that allow the cover to adjust to the thickness of the food. You can easily grill anything from a thinly sliced potato to a thick sirloin steak with even results.

When cooking more than one food item in the Contact Grill, it is important that the thickness of food items is consistent so the cover will close evenly on the food.



### Panini Press

Use the Griddler® as a Panini Press to grill sandwiches, breads and quesadillas.

The word “panini” is Italian for grilled sandwiches. Panini can include any combination of ingredients such as vegetables, meat and cheese layered between two pieces of fresh-baked bread. The sandwich is then pressed between two grill or griddle plates to toast the bread and warm the sandwich. Experiment to make a variety of savory or sweet sandwiches for any meal. We recommend using fresh-baked bread to produce the best tasting panini. Popular breads used for panini are focaccia (a flat bread frequently baked with rosemary,

salt and onion on top), michetta (a small round roll with a crisp crust), ciabatta (a rectangular bread with a slightly domed crust) and thick slices of classic Italian bread.

When the Griddler® is used as a Panini Press, the grill side of the plates is recommended. We recommend the grill side of the plates because traditional-style panini sandwiches have grill marks on the bread. However, depending upon the type of sandwich you are preparing, you may wish to use the griddle side of the plates or any combination of the two. The Griddler® functions as a panini press in the same manner that it functions as a Contact Grill. The Griddler® was designed with a unique handle and hinge that allow the cover to adjust to the thickness of the sandwich you are preparing, and to rest there evenly. Light pressure can be applied to the handle to press and heat the sandwich to your liking.



When cooking two or more panini, it is important that the thickness of the sandwiches is consistent so the cover will close evenly on the panini.

### Full Grill

Use the Griddler® as a Full Grill to cook burgers, steak, poultry (we do not recommend cooking bone-in chicken, since it does not cook evenly on a Full Grill), fish and vegetables.

Full Grill refers to using the Griddler® with the cover lying flat, creating a double, flat cooking surface. In this position, the foods you are grilling will have to be turned over for cooking.

When the Griddler® is used as a Full Grill, the grill side of the plates should be used.



Cooking on the Full Grill is the most versatile method of using the Griddler®.

With the Full Grill, you have double the surface area (200 sq. inches) for grilling. You have the option of cooking different types of foods on separate plates without combining their flavors, or cooking large amounts of the same type of food.

The Full Grill also accommodates different cuts of meat with varying thicknesses, allowing you to cook each piece to your liking.

### Full Griddle

Use the Griddler® as a Full Griddle to cook pancakes, eggs, French toast, hash browns and breakfast meats.

When you use the Griddler® as a Full Griddle, open the cover so it lies flat, creating a double, flat cooking surface. In this position, the foods you are preparing will have to be turned over for cooking. When using this cooking function, the griddle side of the plates should be used.

Cooking on the Full Griddle is a wonderful way to prepare breakfast for two or for a large family.

The large surface area allows you to cook a variety of different foods at the same time, or large amounts of your favorite food.



### Half Grill/Half Griddle

Use the Griddler® as a Half Grill/Half Griddle in order to create full meals like bacon and eggs or steak and potatoes at the same time.

When using the Griddler® as a Half Grill/Half Griddle, simply place the unit in the flat position and insert one plate with the grill side facing up, and another plate with the griddle side facing up. This cooking option allows you to use either the grill/panini temperature or the griddle temperature selector.

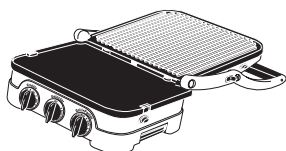

## ASSEMBLY INSTRUCTIONS

Place Griddler® on a clean flat surface where you intend to cook. The Griddler® can be positioned in three ways:

**Closed Position** – Upper plate/cover rests flat on lower plate/base. This is your starting and heating position when using the Contact Grill or Panini Press functions.



**Open Position** – Upper plate/cover is open and in the 100° position. Open the cover to this position before using the Griddler® as a Contact Grill or Panini Press.

To adjust the Griddler® to this position, simply lift the handle until you feel it come to a locking position. The unit will stay in this position until you close the cover or continue to open it to the flat position.



The cover will stay in the upright position until you lower the handle for cooking. When this is done, the cover will release itself so that it lies flat on the top of the food you are preparing. This allows you to cook your food evenly from both top and bottom. When you lift the handle to open the Griddler® after cooking, the cover will remain in the flat position, parallel with the lower plate. In order to lock the cover back into the upright position, you must close the Griddler®, without any food in place, and open it again.

**Flat Position** – Upper plate/cover is level with lower plate/base. The upper and lower plates line

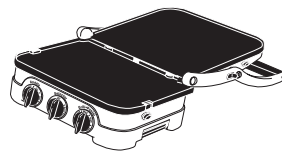

up to create one large cooking surface. The Griddler® is in this position when it is used as a Full Grill, Full Griddle, or Half Grill/Half Griddle.

To adjust the Griddler® to this position, locate the hinge release lever on the right arm.

With your left hand on the handle, use your right hand to slide the lever toward you. Push the handle back until the cover rests flat on the counter. The unit will stay in this position until you lift the handle and cover to return it to the closed position.

If the Griddler® is already in the open position and you wish to adjust it to the flat



position, pull the handle slightly toward you and then lift the hinge release lever. Push the handle back until the cover rests in the flat position. Pulling the handle forward slightly before lifting the hinge release lever will take some of the pressure off of the hinge and you will be able to adjust the Griddler® more easily.

### To insert cooking plates

Adjust the Griddler® to the flat position (see page 5) with the controls directly in front of you. Insert one plate at a time. Each plate is designed to fit in either the upper housing or the lower housing of the Griddler®.

If you are facing the Griddler®, the drip spout should be at the rear of the plate. Locate the metal

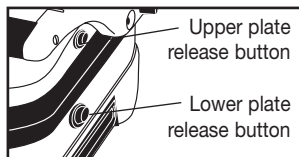

brackets at the center of the housing. Tilt the back end of the plate and line up the cutouts at the back of the plate with the metal brackets. Slide the plate underneath the brackets and push down the front end of the plate. It will snap into place. Turn the Griddler® around and insert the second plate on either its grill or griddle side into the upper housing as you did with the first plate.

### To remove cooking plates

Once the Griddler® is cooled, adjust to flat position (see page 5). Locate the plate release button on one side of the unit. Press firmly on button and the plate will pop up slightly from the base.

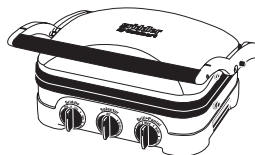

Grasp the plate with two hands, slide it out from under the metal brackets, and lift it out of the base. Press on the other plate release button to remove the other cooking plate in the same manner.

### To position drip tray

One side of the base has a slot provided for the drip tray. Slide the drip tray into the base according to the instruction on the tray.

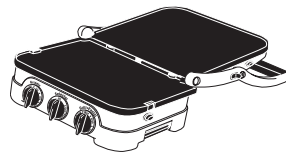

Grease from the food will run off the plates through the grease spout and into the drip tray. Grease should be safely disposed of after the Griddler® has cooled down completely. The drip tray can be cleaned in the dishwasher.

## OPERATING INSTRUCTIONS

Once the Griddler® is assembled properly and you are ready to begin cooking, turn the Selector Dial to the left to choose the Griddle function or to the right to choose the Grill/Panini function, depending on what you intend to cook. When the knob is turned to either function, a red indicator light will illuminate to indicate that the power is on.

If you intend to use the Griddler® as a Contact Grill, Panini Press or Full Grill, turn the Grill/Panini control to the desired temperature for cooking. Settings range from Warm to Sear.

---

If you intend to use the Griddler® as a Full Griddle, turn the Griddle control to the desired temperature for cooking. Settings range from 200°F to 425°F.

If you intend to use the Griddler® as a Half Grill/Half Griddle, you may use either the grill/panini temperature or the griddle temperature.

If you intend to use the Griddler® as a Half Grill/Half Griddle, but you do not need the entire surface, use the bottom plate.

It may take up to 10 minutes to reach operating temperature, depending on the temperature level that was set. When the thermostat has reached operating temperature, a green indicator light inside the chosen control will indicate that the Griddler® is ready for cooking. During operation, the light will continue to turn on and off as the thermostat regulates the temperature. This is normal.

The temperature controls are used to set and maintain the temperature of the cooking surface. You may vary the setting of the control knob at any time during cooking, and may wish to do so depending on the types of foods on the cooking plate. Refer to the Cooked Food Temperature Chart on pages 16–17 of the Recipe Book for recommendations.

Always exercise caution when handling the Griddler® during cooking, as the Griddler® housing will become hot during use. To open the Griddler®, grasp the black plastic area of the handle. This part of the handle stays cool to the touch while cooking. The arms are made of die-cast aluminum and will become hot during use. Do not touch them during or immediately following cooking.

The cover is made of stainless steel and will become very hot and should not be touched during or immediately following cooking. If you need to adjust the cover, be sure to use an oven mitt to prevent burns.

The lower housing is made of plastic and can become very warm. If you need to move the Griddler® during cooking, be sure to handle it from the base only while wearing an oven mitt. Do not touch the cover.

Allow the Griddler® to cool down before handling (at least 30 minutes).

**NOTE:** The first time you use the Griddler®, it may have a slight odor and may smoke a bit. This is normal and common to appliances with nonstick surfaces.

The Griddler® comes with a black cleaning/scraping tool. This can be used for cleaning both the grill and griddle sides of the plates after you have finished cooking and the unit has cooled down completely (at least 30 minutes). Using the cleaning tool on a hot surface for too long will cause the plastic to melt.

## USER MAINTENANCE

- Never use metal utensils, as they will scratch the nonstick plates. Instead, use only wooden or heat-proof plastic utensils.
- Never leave plastic utensils in contact with the hot grill plates. This includes the provided cleaning tool.
- In between recipes, use a wooden or heat-proof plastic utensil to scrape excess food buildup through grease channels and into drip tray, then wipe off any residue with a paper towel before proceeding with next recipe.
- Allow the Griddler® to cool down completely (at least 30 minutes) before cleaning.

## CLEANING AND CARE

**CAUTION: BEFORE CLEANING APPLIANCE, MAKE SURE IT HAS COOLED DOWN COMPLETELY.**

Once you have finished cooking, turn the Selector Dial control to the Off position and unplug the power cord from the wall outlet. Allow the unit to cool down for at least 30 minutes before handling.

Use the cleaning/scraping tool to remove any leftover food from the cooking plate. The scraping tool can be washed by hand or in the dishwasher.

Dispose of grease from the drip tray once cooled. The drip tray can be cleaned by hand or in the dishwasher.



---

Press the plate release buttons to remove plates from the housing. Be sure that the plates have cooled completely before handling (at least 30 minutes). The cooking plates can be washed in the dishwasher. Do not use metallic objects such as knives or forks for cleaning. Do not use a scouring pad for cleaning; the nonstick coating can be damaged.

If you have been cooking seafood, wipe the cooking plate with lemon juice to prevent seafood flavor transferring to the next recipe.

The housing base, cover and control knobs can be wiped clean with a soft, dry cloth. For tough stains, dampen cloth. Never use an abrasive cleaner or harsh pad.

## STORAGE

Always make sure the Griddler® is cool and dry before storing.

The power cord can be wrapped around the back of the base for storing.

The cooking plates and drip tray should be stored in the Griddler® when not in use. The scraping tool can be stored in a drawer or cabinet.

## WARRANTY

### LIMITED THREE-YEAR WARRANTY

This warranty is available to consumers only. You are a consumer if you own a Cuisinart® Griddler® that was purchased at retail for personal, family or household use. Except as otherwise required under applicable law, this warranty is not available to retailers or other commercial purchasers or owners.

We warrant that your Cuisinart® Griddler® will be free of defects in materials and workmanship under normal home use for 3 years from the date of original purchase.

We suggest you complete and return the enclosed product registration card promptly to facilitate verification of the date of original purchase. However, return of the product registration card does not eliminate the need for the consumer to maintain the original proof of purchase in order to obtain the warranty benefits. In the event that you do not have proof of purchase date, the purchase date for purposes of this warranty will be the date of manufacture.

If your Cuisinart® Griddler® should prove to be defective within the warranty period, we will repair it, or if we think necessary, replace it. To obtain warranty service, simply call our toll-free number 1-800-726-0190 for additional information from our Customer Service Representatives or send the defective product to Customer Service at Cuisinart, 150 Milford Road, East Windsor, NJ 08520.

To facilitate the speed and accuracy of your return, please enclose \$10.00 for shipping and handling of the product.

Please pay by check or money order (California residents need only supply proof of purchase and should call 1-800-726-0190 for shipping instructions).

**NOTE:** For added protection and secure handling of any Cuisinart® product that is being returned, we recommend you use a traceable, insured delivery service. Cuisinart cannot be held responsible for in-transit damage or for packages that are not delivered to us. Lost and/or damaged products are not covered under warranty.

Please be sure to include your return address, daytime phone number, description of the product defect, product model # (located on bottom of product), original date of purchase, and any other information pertinent to the product's return.

---

Your Cuisinart® Griddler® has been manufactured to the strictest specifications and has been designed for use with the authorized accessories and replacement parts.

This warranty expressly excludes any defects or damages caused by accessories, replacement parts, or repair service other than those that have been authorized by Cuisinart.

This warranty does not cover any damage caused by accident, misuse, shipment or other ordinary household use.

This warranty excludes all incidental or consequential damages. Some states do not allow the exclusion or limitation of these damages, so these exclusions may not apply to you.

#### **CALIFORNIA RESIDENTS ONLY**

California law provides that for In-Warranty Service, California residents have the option of returning a nonconforming product (A) to the store where it was purchased or (B) to another retail store which sells Cuisinart products of the same type.

The retail store shall then, at its discretion, either repair the product, refer the consumer to an independent repair facility, replace the product, or refund the purchase price less the amount directly attributable to the consumer's prior usage of the product. If the above two options do not result in the appropriate relief to the consumer, the consumer may then take the product to an independent repair facility if service or repair can be economically accomplished. Cuisinart and not the consumer will be responsible for the reasonable cost of such service, repair, replacement, or refund for nonconforming products under warranty.

California residents may also, according to their preference, return nonconforming products directly to Cuisinart for repair, or if necessary, replacement, by calling our Consumer Service Center toll-free at 1-800-726-0190.

Cuisinart will be responsible for the cost of the repair, replacement, and shipping and handling for such products under warranty.

©2009 Conair Corporation  
Cuisinart® is a registered  
trademark of the Conair Corporation  
150 Milford Road  
East Windsor, NJ 08520  
Printed in China

08CE11244

Any other trademarks or service marks referred to herein are the trademarks or service marks of their respective owners.

| Suggested Grilling Temperatures and Times  | Preparation   | Meat                                      |
|--|---|---|
| Sear, 3 to 5 minutes   | Season to taste or marinate.  | Lamb medallions, boneless, ¾-inch thick   |
| High, Grill for 4 to 9 minutes, depending on the thickness of the chops. Internal temperature of 160°F.  | ½ to 1-inch thick. All chops grilled at one time should be same thickness. Pale pink interior. Grilling too long will result in dried meat. | Boneless pork loin chops                  |
| High, in the closed position, for 7 to 9 minutes. If grilling in the flat position, cook on high for 8 to 10 minutes per side. (Internal temperature of 170°F – juices will run clear with no signs of pink).  | Pound to an even thickness of ½ to ¾ inches (all to be grilled should be the same).   | Chicken, boneless, skinless breast halves |
| High, in the closed position, for 8 to 10 minutes. If grilling in the flat position, cook on high for 8 to 10 minutes per side. (Internal temperature of 180°F – juices will run clear with no signs of pink). | Spread to even thickness, remove all visible fat.   | Chicken, boneless, skinless thighs        |
| Sear, about 4 minutes, should be slightly pink in appearance or meat will be dry.  | Cut into ¾-inch thick medallions, may be pounded. Season to taste.  | Pork tenderloin                           |
| High, ¾ to 4 minutes.  | Season to taste or marinate. Drain well if marinated.   | Turkey cutlets, ½-inch thick              |
| Sear, in the closed position, 2 to 2½ minutes. If grilling in the flat position, sear for 2 to 3 minutes per side. Do not overcook.  | Remove tough "foot" (muscle) and discard. Dry well. Season to taste and/or rub with extra virgin olive oil.                                 | Scallops, sea                             |
| Sear, in the closed position, 2 to 2½ minutes. If grilling in the flat position, sear for 1 to 2 minutes per side.   | Shell and devein. Dry well. Season to taste and/or rub with extra virgin olive oil.   | Shrimp                                    |
| High, 6 to 7½ minutes when grilling in the closed position. If using the flat position, cook on High for 7 to 8 minutes per side.  | About ¾-inch thick to 1-inch thick.   | Fish steaks (sword, tuna, salmon/boned)   |
| High, 6 to 8 minutes, until nicely brown and tender.   | Cut into ½-inch thick slices.   | Portobello mushrooms                      |

# Cooking Guide and Food Temperature Chart

Following are suggested grilling times for the Griddler<sup>®</sup>, using the grill side of the plates in the closed position. Times are approximate and will vary with temperature of items being grilled. Only boneless poultry, meat and seafood should be grilled – plates will maintain contact with bones, but will lose contact with meat as it cooks and it will appear “steamed.” Preheat Griddler<sup>®</sup> with the unit closed according to instructions before grilling.

Marinades can be used, but draining is suggested before placing on the hot Griddler. An instant-read thermometer or a probe-type thermometer is a handy tool for checking the internal temperature of foods grilled.

| Meat                                    | Preparation  | Suggested Grilling Temperatures and Times  |
|---|--|--|
| Bacon                                   | Not recommended for grilling on Griddler <sup>®</sup> in closed position. Cook on grill or griddle side of plates in flat position only. | High, until desired doneness.  |
| Beef, boneless steak, ¾ to 1-inch thick | Season to taste. Drain off marinade well if marinated before grilling.   | Sear, in the closed position, 3 to 10 minutes. Sear, in the flat position, for 3 to 5 minutes per side.  |
| Beef, filets, 1-inch thick              | Season to taste  | Sear, 4 to 5 minutes.  |
| Beef, hamburgers                        | Shape meat into burgers of even weight and thickness.  | Sear, 5 to 8 minutes to degree of desired doneness. USDA recommends cooking ground meat to an internal temperature of 160°F (nearly well done).<br>135° to 140°F – medium rare<br>145° to 150°F – medium well<br>150° to 155°F – medium<br>165° to 170°F – well done |
| Ham steak                               | Dry thoroughly with paper towels; remove bone if there is one.   | High-Sear<br>About 4 to 5 minutes.   |
| Hot dogs, cooked sausages               | Splitting your hot dogs or sausages gives them a deeper grilled flavor.  | High, in the closed position, 3 to 4 minutes if grilling split hot dogs or sausages.<br>Whole sausages take 6 to 10 minutes in the closed position.<br>If grilling in the flat position, always split the hot dogs or sausages. Flip after 3 to 4 minutes.           |
| Sausages, uncooked                      | Prick links with tines of fork or tip of paring knife.   | High. Grill for 14 to 18 minutes in the closed position, depending on thickness of sausage.  |

continues next page

*Nutritional information per serving:*  
 Calories 382 (56% from fat) • carb. 39g • pro. 4g • fat 24g • sat. fat 8g  
 • chol. 109mg • sod. 72mg • calc. 25mg • fiber 2g

Serve warm pears on warm grilled pound cake.  
 Arrange the pears in a single layer on the griddle, and cook for 4 to 5 minutes. Turn and cook for 3 to 4 minutes longer until tender and caramelized. While the pears are cooking, arrange the pound cake on the grill and grill for 4 to 5 minutes on each side, until browned and warm.  
 Select Griddle and preheat to 400°F with the unit closed.  
 Insert one plate on its grill side and another on its griddle side on the Cuisinart® Griddle®.  
 Spread ½ teaspoon of the softened butter on each side of each slice of pound cake.  
 Cut each pear half into eight slices. Put into a bowl with lemon juice and toss gently. Add melted butter, brown sugar, and cinnamon. Stir gently to coat. Let stand for 15 minutes.

|   |  |
|---|--|
| 8 | slices pound cake, each about ½ to ¾-inch thick      |
| 8 | teaspoons unsalted butter, at room temperature       |
| 1 | teaspoon ground cinnamon                             |
| 1 | tablespoon light brown sugar                         |
| 1 | tablespoon unsalted butter, melted                   |
| 2 | teaspoons fresh lemon juice                          |
| 2 | large pears, firm but ripe, peeled, halved and cored |

Makes 8 servings

Plate Side: Half Grill/Half Griddle

Selector: Griddle

Griddle® Position: Flat

## Grilled Pound Cake with Cinnamon Glazed Pears

*Nutritional information per serving (one sandwich):*  
 Calories 449 (40% from fat) • carb. 56g • pro. 11g • fat 20g • sat. fat 11g  
 • chol. 36mg • sod. 656mg • calc. 148mg • fiber 1g

Insert plates on grill or griddle side.  
 Preheat the Cuisinart® Griddle® to High with the unit closed while assembling panini. Put cream cheese, sugar, and vanilla into a small bowl and stir to combine. Add raisins and blend well.  
 Butter the bread slices on one side with butter and place them buttered sided down. Spread two slices with sweetened cream cheese/raisin mixture. Top with remaining bread, buttered side up, and press together lightly.  
 Place each panini on preheated Griddle® and close. Grill for about 2½ to 3 minutes, until bread is crisp and toasty with grill markings and filling is warm. Let stand 3 to 5 minutes on a rack before cutting (do not serve too soon). Cut and sprinkle with powdered sugar if desired before serving.

|    |  |
|----|--|
| 1½ | teaspoons granulated sugar                 |
| ¼  | teaspoon pure vanilla extract              |
| 2  | tablespoons raisins or dried tart cherries |
| 4  | teaspoons softened unsalted butter         |
| 4  | slices cinnamon swirl toasting bread       |
|    | powdered sugar for sprinkling (optional)   |

Measure out 2 cups of mashed potatoes and put into a medium bowl. (Discard extra potatoes or reserve for another use.) Add cheese, beaten egg, shallot, parsley, olive oil, remaining salt, and pepper. Stir to blend.

Preheat Cuisinart® Griddler® to 375°F with the unit closed, then open preheated unit to extend flat. Scoop out potato mixture using a ¼-cup measure. Arrange 4 scoops on each side of the griddle. Cook for 6 to 7 minutes per side, until golden and crispy on the outside and hot on the inside. Serve hot.

\*Cheese may be varied according to personal preference. Try crumbled chèvre or feta, or grated Cheddar, Gouda, Farnesana, etc.

*Nutritional information per cake:*  
 Calories 69 (37% from fat) • carb. 8g • pro. 3g • fat 3g • sat. fat 1g  
 • chol. 31mg • sod. 255mg • calc. 37mg • fiber 1g

## Grilled Green Beans with Feta

Griddler® Position: Closed  
 Selector: Grill/Panini  
 Plate Side: Grill

Makes 4 servings

1 pound green beans, rinsed  
 1½ teaspoons extra virgin olive oil  
 ¼ teaspoon kosher salt  
 1 tablespoon fresh lemon juice  
 ½ teaspoon basil  
 ½ teaspoon freshly ground black pepper  
 ¼ cup crumbled feta cheese

Insert the plates on their grill side.

Preheat the Cuisinart® Griddler® to High with the unit closed. Remove tips and tops from green beans. Put into a bowl and drizzle with olive oil. Toss to coat. When Griddler® is hot, arrange half the green beans on the bottom grill plate. Close and grill for 5 to 6 minutes. Using a pair of heatproof tongs for nonstick cookware, remove the green beans and transfer to a bowl. Sprinkle with half the salt. Grill remaining green beans and add to the bowl. Sprinkle with the remaining salt, lemon juice, basil and pepper; toss to coat. Arrange green beans in a shallow serving bowl and sprinkle with crumbled feta cheese.

*Nutritional information per serving:*  
 Calories 61 (34% from fat) • carb. 9g • pro. 3g • fat 3g • sat. fat 1g  
 • chol. 3mg • sod. 130mg • calc. 64mg • fiber 4g

## DESSERTS

### Cheese & Raisin Danish on Swirl Bread Panini



Griddler® Position: Closed  
 Selector: Grill/Panini  
 Plate Side: Grill or Griddle

Makes 2 panini

3 ounces lowfat cream cheese

# Teriyaki Grilled Chicken

Griddler® Position: Flat  
 Selector: Grill/Panini  
 Plate Side: Grill

Makes 4 servings

- 1/2 cup low-sodium soy sauce
- 3 tablespoons rice vinegar
- 2 tablespoons dry or medium dry sherry (or may use mirin)
- 2 tablespoons brown sugar, packed
- 2 teaspoons powdered ginger
- 1 1/2 pounds boneless, skinless chicken thighs

Put soy sauce, vinegar, sherry, brown sugar, and ginger into a medium bowl and stir with a whisk to blend. Makes 2/3 cup marinade.

Trim all visible fat from chicken and add chicken to marinade in bowl; stir to coat. Allow to marinate for 20 to 30 minutes (may marinate longer – cover and refrigerate).

Preheat Cuisinart® Griddler® to High with the unit closed.

Drain the chicken, put the marinade into a small saucepan and bring to a boil. Reduce heat to low and simmer until chicken is ready (do not save and use marinade as a sauce unless you perform this step). Open preheated unit to extend flat. Arrange the chicken, "skin" side down, evenly spaced on the grill. Grill for 6 to 7 minutes per side – chicken juices should run clear and test 170°F when checked with an instant-read thermometer. Transfer to warm plate and pour the simmered reserved sauce over the chicken. Serve with steamed brown or white rice.

*Nutritional information per serving:*

Calories 486 (36% from fat) • carb. 30g • pro. 47g • fat 19g • sat. fat 5g  
 • chol. 162mg • sod. 1012mg • calic. 44mg • fiber 2g

# SIDE DISHES

## Potato & Gorgonzola Cakes

Griddler® Position: Flat

Selector: Griddle

Plate Side: Griddle

Makes 8 cakes

- 2 large (10 ounces each) russet potatoes, peeled, thickly sliced
- 1 teaspoon kosher salt, divided
- 1/3 cup finely crumbled Gorgonzola cheese\*
- 1 large egg, lightly beaten
- 1 tablespoon finely minced shallot
- 1 tablespoon chopped fresh parsley
- 1 teaspoon extra virgin olive oil
- 1/6 teaspoon freshly ground black pepper

Put potatoes into a medium saucepan and cover with 1 inch of water. Stir in 1/2 teaspoon salt. Bring to a boil over high heat. Reduce heat to medium and simmer for 15 to 18 minutes, or until potatoes are fork tender. Drain, reserving 1/4 cup cooking liquid. Put potatoes into a bowl with the reserved liquid. Mash potatoes using a potato masher or ricer.

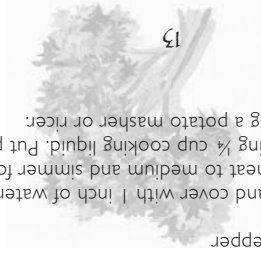

## Herb Grilled Boneless Pork Chops

Griddler® Position: Closed

Selector: Grill/Panini

Plate Side: Grill

Makes 4 servings

- 1 teaspoon herbes de Provence or Italian herb blend
- ½ teaspoon kosher salt
- ½ teaspoon paprika (sweet or hot, to taste)
- ¼ teaspoon dry mustard
- ¼ teaspoon freshly ground black pepper
- 4 boneless pork loin chops, all the same thickness (½ to ¾ inch), each about 5 ounces

Combine herbs, salt, paprika, dry mustard, and pepper. Blend well. Rub evenly on pork chops. Let stand for 15 to 20 minutes. (Or may be done early in day, covered and refrigerated.)

Insert plates on their grill side. Preheat Cuisinart® Griddler® to High with the unit closed. When hot, arrange the seasoned pork chops evenly spaced on the lower grill plate.

Close and grill for 4½ to 9 minutes – grilling time will depend on thickness and temperature of meat. Internal temperature of pork should register about 150°–160°F when tested with an

instant-read thermometer.

Nutritional information per serving:

Calories 289 (37% from fat) • carb. 0g • pro. 43g • fat 12g • sat. fat 4g • chol. 116mg • sod. 543mg • calc. 52mg • fiber 0g

- ½ teaspoon ground coriander
- ½ teaspoon oregano
- ½ teaspoon paprika
- ½ teaspoon kosher salt
- ½ teaspoon freshly ground black pepper
- 2 boneless rib eye or strip steaks, ¾-inch thick each (12 ounces each)

Put the cumin, chili powder, basil, coriander, oregano, paprika, salt, and pepper into a small bowl and stir to combine – there will be about 2 tablespoons. Reserve. Dry steaks and rub evenly with prepared spice rub. Let stand 20 to 30 minutes – or rub, cover and refrigerate for up to 12 hours. Insert plates on their grill side. Preheat the Cuisinart® Griddler® to Sear with the unit closed. When hot, arrange steaks evenly spaced on lower grill. Cover, using light pressure. Grill until steaks have reached desired level of doneness when tested with an instant-read thermometer. Grilling will take approximately 3 to 10 minutes. Grill until about 5° under temperature desired – meat will continue to cook while resting. Remove immediately. Let steaks stand for 5 to 10 minutes before serving to allow temperature to even out, and fibers to relax and reabsorb the juices, making the steak more tender and juicy.

Nutritional information per serving:

Calories 386 (48% from fat) • carb. 1g • pro. 48g • fat 20g • sat. fat 8g • chol. 140mg • sod. 294mg • calc. 19mg • fiber 0g

Calories 289 (37% from fat) • carb. 0g • pro. 43g • fat 12g • sat. fat 4g • chol. 116mg • sod. 543mg • calc. 52mg • fiber 0g



## Southwestern Spiced Grilled Rib Eye Steaks

*Nutritional information per serving:*  
 Calories 464 (55% from fat) • carb. 1g • pro. 50g • fat 27g • sat. fat 11g • chol. 148mg • sod. 456mg • calc. 57mg • fiber 0g

Put the herbes de Provence, salt and pepper into a small bowl. Stir to blend; reserve.  
 Using a sharp knife, cut a horizontal slit in the side of a filet, then carefully cut into the center of the filet to create a pocket – do not cut all the way through to the sides. Repeat for each filet. Place one tablespoon of the cheese in each pocket – press the open sides together tightly. Drizzle the filets with the olive oil and rub in to coat completely and evenly. Sprinkle the filets on both sides with the herb mixture and press into the meat. Refrigerate for 20 to 30 minutes before grilling. (Filets may be prepared up to 8 hours ahead and refrigerated.)  
 Insert plates on their grill side. Preheat Cuisinart® Griddle® to Sear with the unit closed. When Griddle® is hot, arrange the filets evenly spaced on the grill. Cover, using light pressure. Grill until steaks have reached desired level of doneness when tested with an instant-read thermometer. Grilling will take approximately 6 to 10 minutes. Grill until about 5" under temperature desired – then continue to cook while resting. Remove immediately. (Note: this type of beef has more flavor and better texture when cooked rare to medium.) Let meat rest for 5 to 10 minutes before serving.

Makes 4 servings  
 Griddle® Position: Closed  
 Selector: Grill/Panini  
 Plate Side: Grill  
 2 tablespoons herbes de Provence  
 1 teaspoon kosher salt  
 ½ teaspoon freshly ground black pepper  
 4 beef tenderloin filets, each about 6 ounces – 1-inch thick  
 4 tablespoons cold Saga Blue cheese (may also use Brie, mushroom Brie or Cambozola cheese)  
 1 tablespoon good quality olive oil

## Saga Blue Stuffed Beef Filets with Herb Crust

*Nutritional information per fajita:*  
 Calories 106 (29% from fat) • carb. 10g • pro. 9g • fat 3g • sat. fat 0g • chol. 57mg • sod. 146mg • calc. 55mg • fiber 1g

While second batch of vegetables is cooking, brush tortillas with oil, and begin to warm. 1 to 2 minutes per side on the griddle. Reserve.  
 Sprinkle shrimp with ¼ teaspoon of salt and grill for about 2 to 3 minutes per side. Serve all fajita ingredients with salsa, sour cream, and sliced avocado so each individual can prepare his/her own.

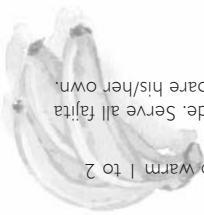

Griddle® Position: Closed  
 Selector: Grill/Panini  
 Plate Side: Grill  
 Makes 2 to 4 servings  
 1 teaspoon ground cumin  
 1 teaspoon chili powder  
 ½ teaspoon basil

## Variations

Burgers may be seasoned for variety before they are grilled. Gently stir one or a combination of these suggested seasonings or your own favorites into the meat, working the meat as little as possible for best texture.

- 1 to 2 cloves finely minced garlic
- 2 to 3 finely chopped green onions
- 1 teaspoon minced fresh ginger
- 1 to 2 tablespoons soy sauce
- 1 to 2 tablespoons Worcestershire sauce
- 1 tablespoon minced capers
- 1 to 2 tablespoons minced imported olives
- 1 to 2 tablespoons barbecue sauce
- hot sauce to taste
- minced jalapeño pepper to taste

## Shrimp Fajitas

Griddle® Position: Flat

Selector: Griddle

Plate Side: Half Grill/Half Griddle

Makes about 12 fajitas

Marinade:

- 8 sprigs fresh cilantro
- 1 tablespoon fresh lime juice
- 1 tablespoon chili powder
- ¼ teaspoon cayenne
- 2 smashed cloves of garlic
- 1 jalapeño pepper, seeded and sliced
- 1 tablespoon extra virgin olive oil
- 1 pound large shrimp, peeled and deveined

Vegetables:

- ½ red bell pepper, thinly sliced
- ½ yellow bell pepper, thinly sliced
- 1 jalapeño pepper, seeded and thinly sliced
- 1 small onion, thinly sliced
- 1 tablespoon extra virgin olive oil + extra for brushing tortillas
- ¼ teaspoon chili powder
- ¼ teaspoon kosher salt
- pinch cayenne pepper
- 12 small (6-inch) corn tortillas

Combine the marinade ingredients (cilantro, lime juice, chili powder, cayenne, garlic, jalapeño, and olive oil) in a medium stainless or glass mixing bowl and stir. Add the shrimp to marinade and refrigerate for an hour.

Insert one plate on its grill side and another on its griddle side on the Cuisinart® Griddle®. Select Griddle and preheat to 425°F with the unit closed.

In a mixing bowl toss sliced peppers and onion with the tablespoon of olive oil, ¼ teaspoon of chili powder, ¼ teaspoon of salt, and cayenne. When green indicator light illuminates, open the unit to extend flat and place vegetables on the grill side in a single layer, cooking them in two batches. Stir the vegetables occasionally during cooking and remove when tender and browned, about 8 minutes per batch; reserve.

- 1/2 teaspoon garlic powder
- 1/2 teaspoon dried thyme
- 1/4 teaspoon kosher salt
- 1/8 teaspoon paprika
- 1/8 teaspoon cayenne
- 1 pound flounder filets (or other boneless fish filets such as haddock, hake, cod)
- 8 ounces new red potatoes (about 2 to 3 inches in diameter), scrubbed
- tartar sauce (recipe follows)
- sliced lemon wedges

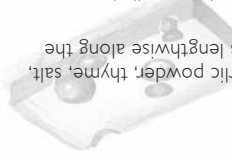

Put 1 tablespoon of the olive oil into a medium bowl with the lemon juice, garlic powder, thyme, salt, paprika, and cayenne; stir to blend. Pat fish dry and cut each fillet into 2 pieces lengthwise along the bone line. Add fish to bowl and toss gently to coat with seasoned oil mixture.

Slice the potatoes into thin slices (approximately 4 mm or 1/8 inch – this can be done easily in a Cuisinart® Food Processor). Place in a bowl and toss with the remaining olive oil.

Insert one plate on its grill side and another plate on its griddle side on the Cuisinart® Griddler®. Select Griddle and preheat to 425°F with the unit closed. Preheat oven to 200°F.

Open preheated unit to extend flat. In 2 or 3 batches, arrange sliced potatoes on hot grill plate. Grill for 6 to 8 minutes on each side. As they are cooked, transfer to a platter and keep warm in the oven. When the last batch of potatoes is ready to turn, arrange the fish filets on the hot griddle. Cook for 4 to 5 minutes on each side.

Serve hot with grilled potatoes, tartar sauce, and fresh lemon wedges.

*Nutritional information per serving:*  
 Calories 420 (36% from fat) • carb. 22g • pro. 45g • fat 16g • sat. fat 3g  
 • chol. 109mg • sod. 358mg • calc. 57mg • fiber 2g

## The Best Hamburger

Griddler® Position: Closed  
 Selector: Grill/Panini  
 Plate Side: Grill

Makes 4 servings

- 1 1/2 pounds freshly ground beef round or chuck (15% lean)
- 1/4 teaspoon kosher salt
- 1/4 teaspoon freshly ground black pepper

Preheat Cuisinart® Griddler® to Sear with the unit closed.

Working the ground chuck as little as possible, shape into four 6-ounce burger patties, about 4 inches in diameter. The best way to do this is to use a 4-inch round cookie cutter. Put 6 ounces of meat in the cookie cutter and gently press to fill the cookie cutter evenly. It is important that all the burgers be of the same height for optimal grilling results.

When Griddler® has preheated, place the burgers on the bottom grill plate, evenly spaced. Close the Griddler® and grill for 5 to 8 minutes (until the internal temperature reaches from 140°F to 165°F) depending on personal preference. Remove burgers and sprinkle with salt and pepper. Serve hot with your favorite condiments.

*Nutritional information per serving:*  
 Calories 254 (18% from fat) • carb. 1g • pro. 30g • fat 20g • sat. fat 8g  
 • chol. 87mg • sod. 324mg • calc. 7mg • fiber 0g

1/2 tablespoons fresh lemon juice  
2 tablespoons extra virgin olive oil, divided  
Makes 2 servings

Griddler® Position: Flat  
Selector: Griddle  
Plate Side: Half Grill/Half Griddle

## Not Fried Fish and Chips

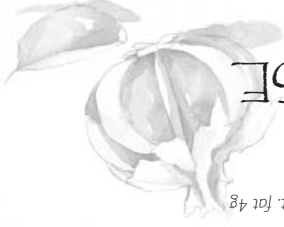

## THE MAIN COURSE

*Nutritional information per serving (one quesadilla):*  
Calories 366 (24% from fat) • carb. 25g • pro. 43g • fat 10g • sat. fat 4g  
• chol. 100mg • sod. 564mg • calc. 289mg • fiber 1g

\*This can be from a purchased roast or rotisserie chicken.  
Tortilla is warm with grill markings, filling is warm and cheese is melted. Serve with salsa if desired.  
bottom. Lightly brush the tops and bottoms of the wraps with the olive oil. Place quesadilla wraps on preheated Griddler®. Close, using medium-light pressure. Grill/bake for 3½ to 4 minutes, until bottom over short sides to cover, then fold last side over to close. Turn over so that flap is on long in the center of the tortilla. Fold one side over the filling lengthwise to cover, fold top and chicken mixture, keeping the chicken mixture in a "log" about 1½ inches wide and 4 to 5 inches onion, and jalapeño peppers. Sprinkle half the cheese in the center of each tortilla. Top with the Preheat Cuisinart® Griddler® to High with the unit closed. In a small bowl, combine the chicken, Insert the plates on their grill side.

1/2 cups shredded/chopped cooked chicken\*  
1/2 cup chopped cooked onion (sautéed until tender)  
2 tablespoons chopped jalapeño peppers  
6 tablespoons shredded lowfat Cheddar or Monterey Jack cheese  
2 9-inch flour tortillas or wraps (can use plain, herb, spinach)  
1 tablespoon olive oil

Makes 2 quesadilla wraps, 2 servings

Griddler® Position: Closed  
Selector: Grill/Panini  
Plate Side: Grill

## Chicken Quesadilla Wraps

*Nutritional information per serving (based on 4 servings):*  
Calories 260 (37% from fat) • carb. 27g • pro. 15g • fat 11g • sat. fat 1g  
• chol. 20mg • sod. 574mg • calc. 276mg • fiber 1g

about 20 to 30 minutes.  
\*If sauce seems thin or watery, thicken it by placing it in a strainer lined with a coffee filter for 5 minutes on a wire rack. Use a pizza wheel to cut into 4 or more wedges. Serve while warm.  
Arrange cheese slices over sauce, add sausage, pepperoni or sliced vegetables if using. Top with second crust, oiled side up. Place on preheated Griddler®. Grill for 8 to 9 minutes, until crust is crispy and well marked with grill lines, and filling is hot. Remove pizza panini and let rest for

# Zucchini ai Quattro Formaggi Panini

Griddler® Position: Closed  
Selector: Grill/Panini  
Plate Side: Grill

Makes 4 servings

- 10 ounces shredded zucchini
- 1/2 teaspoon kosher salt
- 4 ounces shredded fresh mozzarella
- 2 ounces shredded fontina
- 2 ounces shredded sharp provolone
- 2 tablespoons freshly grated Parmigiano-Reggiano or Asiago
- 1 teaspoon dried basil
- 8 slices crusty country bread (about 8 x 4 x 1/2 inches)
- 4 teaspoons extra virgin olive oil

Put the shredded zucchini into a colander and toss with salt. Let stand for 20 minutes. After 20 minutes, rinse and press out as much liquid as possible. Place in a clean tea towel and squeeze until no more liquid is released. Put into a medium bowl with the four cheeses and the basil. Toss gently to combine. You should have about 3 cups.

Preheat Cuisinart® Griddler™ to High with the unit closed. Preheat conventional oven to 175°F. Lightly brush one side of bread with olive oil. Place 4 slices of bread on the work surface, oiled side down. Divide the shredded zucchini and cheese mixture evenly among the 4 slices of bread – making as even a layer as possible. Top with the remaining sliced bread, oiled side up.

When Griddler® has preheated, place two sandwiches on the bottom grill plate, evenly spaced. Lower cover and apply light pressure to handle for about 30 seconds. Grill panini for 3/2 to 4 minutes. Remove to a rack and keep warm in preheated oven. Grill remaining 2 sandwiches in the same way. Cut in half on the diagonal to serve.

*Nutritional information per serving:*

Calories 380 (49% from fat) • carb. 28g • pro. 20g • fat 21g • sat. fat 10g • chol. 52mg • sod. 665mg • calc. 390mg • fiber 1g

# Pizza Panini

Griddler® Position: Closed  
Selector: Grill/Panini  
Plate Side: Grill

Makes one 8-inch double-crust panini, 2 to 4 servings

- 2 8-inch thin-crust pre-baked pizza crusts, such as Boboli®
- 1/2 tablespoon extra virgin olive oil or may use olive oil spray
- 1/4 cup thick marinara sauce\*
- 4 ounces sliced part-skim mozzarella (can be increased to 6 ounces if a "cheesier" sandwich is preferred) or provolone
- crumbled cooked sausage or julienned
- thinly sliced pepperoni, or cooked thinly
- sliced vegetables such as mushrooms or zucchini (optional)

Insert the plates on their grill side. Preheat Cuisinart® Griddler™ to Medium-High with the unit closed.

Brush "bottom" sides of each crust with olive oil or lightly spray with cooking spray. Place one crust on work surface, oiled side down. Top with sauce spread to within 1/2 inch of all edges.

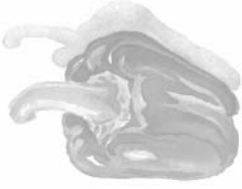

*Calories 565 (31% from fat) • carb. 69g • pro. 27g • fat 19g • sat. fat 8g • chol. 39mg • sod. 1601mg • calc. 271mg • fiber 1g*  
 Nutritional information per serving:

Cut off the two heels of the baguette and cut the baguette into two 10-inch lengths. Cut each in half horizontally. Lightly brush the outside of each piece of bread with olive oil. Spread each half with 1 teaspoon pesto. Evenly layer the sopressata on each bottom. Cut the roasted peppers to lie flat. Arrange the roasted peppers over the sopressata. Top with a layer of the provolone. Place top on sandwich. Cut in half crosswise to make 4 sandwiches total. Preheat Cuisinart® Griddle™ to High with the unit closed. When Griddle™ is ready, place the sandwiches on the bottom grill plate. Lower cover and press lightly on the handle for 30 seconds. Grill for 5 minutes, until the bread is golden, toasty and well marked, the filling is warm and cheese is melted. Serve warm.

Makes 4 servings  
 Griddle® Position: Closed  
 Selector: Grill/Panini  
 Plate Side: Grill  
 1 long French baguette (about 22 inches long)  
 1 tablespoon extra virgin olive oil  
 4 teaspoons pesto  
 4 ounces thinly sliced sopressata  
 2 roasted red peppers, drained  
 4 ounces sliced provolone

## Sopressata, Provolone, Roasted Pepper & Pesto Panini

*Calories 366 (41% from fat) • carb. 34g • pro. 20g • fat 16g • sat. fat 7g • chol. 46mg • sod. 1088mg • calc. 201mg • fiber 3g*  
 Nutritional information per serving:

Trim asparagus and peel. Toss asparagus with 2 teaspoons of the olive oil. Lay the oiled asparagus on the bottom plate of the preheated grill. Cover and cook until crisp and bright, about 4 to 5 minutes. Reserve. Put shredded cheese and herbes de Provence into a small bowl and toss to combine; reserve. Drain roasted peppers well and pat dry. Preheat conventional oven to 175°F. Lightly brush one side of each slice of bread with the remaining olive oil. Place 4 slices of bread on the work surface, oiled side down. Build the sandwiches in this order – shredded cheese, asparagus, roasted peppers, and prosciutto – using equal amounts of each item on each sandwich. Top with the remaining sliced bread, oiled side up. Place two sandwiches on the bottom grill plate, evenly spaced. Lower cover and apply light pressure to handle for about 30 seconds. Grill panini for 3½ to 4 minutes. Remove to a rack and keep warm in preheated oven. Grill remaining 2 sandwiches in the same way. Cut in half on the diagonal to serve.

# Weekend Breakfast for 2



- Griddle Position: Flat
- Selector: Griddle
- Plate Side: Half Grill/Half Griddle
- 4 slices bacon – or strips of Canadian bacon – or sausage patties
- 2 slices good quality bread
- 2 teaspoons unsalted butter, melted, divided
- 1 teaspoon unsalted butter, divided
- 2 large eggs
- kosher salt and freshly ground black pepper to taste

Insert one plate on its grill side and another on its griddle side on the Cuisinart® Griddler®. Select Griddle and preheat to 350°F with the unit closed. Open to extend flat. Arrange bacon, Canadian bacon, or sausage on grill plate and begin cooking.

While meat is cooking, brush both sides of each slice of bread with 2 teaspoons of the melted butter. Use a 3-inch round or square cookie cutter to cut a center out of each slice of bread. After meat has been cooking for 7 to 8 minutes, turn. Arrange buttered bread and cut-out centers on hot griddle plate. Let cook for 4 to 5 minutes until lightly golden brown and toasted. Turn. Add ½ teaspoon unsalted butter to the griddle plate in the open center of each slice of bread. Break an egg into the center of each slice of bread. Let cook until whites are firm, about 4 to 5 minutes. If desired, carefully turn using a nonstick heat resistant spatula. Cook for 1 to 2 minutes, to desired preference. Transfer to warmed plates. Season to taste with kosher salt and freshly ground pepper. Drain bacon or sausage on double layer of paper towels. Slice griddle toasted cut-out “center” of bread in half and use for dipping.

*Nutritional information per serving:*  
 Calories 479 (72% from fat) • carb. 20g • pro. 13g • fat 38g • sat. fat 15g • chol. 259mg • sod. 577mg • calc. 44mg • fiber 1g

## PANINI

### Asparagus, Prosciutto, Roasted Pepper & Fontina Panini

Griddler® Position: Closed  
 Selector: Grill/Panini  
 Plate Side: Grill

- Makes 4 servings
- 20 spears asparagus
- 2 tablespoons extra virgin olive oil, divided
- 4 ounces shredded fontina cheese
- 1 teaspoon herbes de Provence
- 2 roasted red peppers (about one 12-ounce jar, drained)
- 8 slices crusty country bread (each about 8 x 4 x ½)
- 2 ounces thinly sliced prosciutto (8 very thin slices)

Preheat Cuisinart® Griddler® to High with the unit closed.

## Breakfast Sausage

*Nutritional information per pancake:*  
 Calories 121 (29% from fat) • carb. 18g • pro. 4g • fat 4g • sat. fat 1g  
 • chol. 28mg • sod. 184 mg • calc. 47mg • fiber 1g

When Griddle® has preheated, open unit to extend flat. Drop the batter onto the grill plates, using a scant quarter-cup measure. Cook the pancakes for 3½ to 4 minutes. When pancakes are bubbling on the top, turn and cook for an additional 2 to 3 minutes. Blueberry Cat Pancakes are best served hot. Pancakes can be kept warm by placing them on a rack on a baking sheet in a low (175°–200°F) oven while cooking the remainder.

Serve with warm syrup and butter as desired.

Griddle® Position: Closed or Flat  
 Selector: Griddle  
 Plate Side: Griddle

Makes 10 sausage patties (about 1¼ ounces each)

12 ounces ground turkey (can use very lean)  
 4 ounces lean ground pork  
 ½ cup very finely chopped tart apple  
 1 tablespoon very finely minced onion  
 2 tablespoons chopped fresh parsley (1 tablespoon dried parsley)  
 1 teaspoon rubbed sage  
 ½ teaspoon thyme  
 1 teaspoon kosher salt  
 ¼ teaspoon freshly ground black pepper  
 ¼ teaspoon paprika

Put all ingredients into a medium bowl and mix as for meatloaf – combining thoroughly to distribute the seasonings evenly. Unlike ground meat for burgers, which should not be overmixed, it is important to completely mix the meat and seasonings. Shape into ten patties of equal size (about 1¼ ounces each, ½ to 2 inches in diameter). This may be done the night before, or sausage may be made ahead and frozen.

The sausage may be cooked using either the flat or closed griddle position. For closed griddle cooking, preheat the Cuisinart® Griddle to 425°F with the unit closed. Arrange the sausage patties evenly spaced on the hot griddle plate. Cook the patties for 5 to 6 minutes, until they have reached an internal temperature of 170°F. This is a great, quick way to cook sausage for sausage biscuits or other breakfast sandwiches.

To cook the sausage patties on the full griddle, preheat the Cuisinart® Griddle to 375°F with the unit closed. In the flat position, cook the sausage for 14 to 16 minutes total, turning once after 8 minutes. Cooking on the full griddle allows you to cook eggs or pancakes to accompany the sausage, either on one side of the Griddle® or when finished cooking the sausage.

### Recipe note:

If you have a Cuisinart® Food Processor, you may use it to chop your own freshly ground turkey and pork. Follow the instructions that accompany your processor. After chopping the meat, you may add the chopped apples, onions and seasonings using the pulse until completely combined.

*Nutritional information per sausage patty:*  
 Calories 75 (11% from fat) • carb. 1g • pro. 11g • fat 3g • sat. fat 1g  
 • chol. 27mg • sod. 166mg • calc. 13mg • fiber 0g



# BREAKFAST

## Cinnamon Sugar French Toast

Griddle® Position: Flat

Selector: Griddle

Plate Side: Griddle

Makes 4 servings (2 slices per serving)

8 slices (preferably thick sliced) cinnamon swirl or cinnamon raisin bread

5 large eggs

1 cup evaporated fat-free milk (not reconstituted)

¼ cup half-and-half (may use fat free)

¼ teaspoon salt

1 teaspoon ground cinnamon

1 tablespoon pure vanilla extract

pinch nutmeg (freshly grated)

Arrange the bread in two 8 x 8 x 2-inch glass baking dishes. Whisk eggs, evaporated milk, half-and-half, salt, spices, and vanilla until smooth but not foamy. Pour the batter over bread. Turn the bread over, let sit 5 minutes, then turn the bread over again.

Preheat the Cuisinart® Griddle® to 325°F with unit closed. When Griddle® is ready, open unit

to extend flat and arrange the soaked bread on the hot griddle. Cook until deep golden brown

on each side, about 4 to 5 minutes per side. French toast can be kept warm on a rack on a baking

sheet in a low (200°F) oven.

*Nutritional information per serving:*

Calories 308 (31% from fat) • carb. 36mg • pro. 17 • fat 10g • sat fat 4g  
• chol. 271mg • sod. 947mg • calc. 274mg • fiber 3g

## Blueberry Oat Buttermilk Pancakes

Griddle® Position: Flat

Selector: Griddle

Plate Side: Griddle

Makes 16 pancakes

1 cup blueberries (fresh or frozen)

1 cup all-purpose flour, divided

1½ cups rolled oats (regular, not quick oats)

¼ cup whole wheat flour

¼ cup brown sugar

1 teaspoon baking soda

½ teaspoon salt

2 cups buttermilk

2 large eggs, lightly beaten

3 tablespoons vegetable oil

Put the blueberries into a small bowl. Sprinkle with 1 tablespoon of the flour and toss to coat;

reserve. Preheat Cuisinart® Griddle® to 375°F with unit closed.

Put the remaining flour, oats, wheat flour, brown sugar (break up any lumps), baking soda, and salt

into a medium bowl; stir with a whisk. Put the buttermilk, eggs and oil into a small bowl; stir. Add

the liquid mixture to the dry ingredients and stir with a whisk until blended. Gently fold in the

blueberries.



## BREAKFAST

|   |   |
|---|---|
| Cinnamon Sugar French Toast .....       | 3 |
| Blueberry Oat Buttermilk Pancakes ..... | 3 |
| Breakfast Sausage .....                 | 4 |
| Weekend Breakfast for Two .....         | 5 |

## PANINI

|  |   |
|--|---|
| Asparagus, Prosciutto, Roasted Pepper & Fontina Panini ..... | 5 |
| Sopressata, Provolone, Roasted Pepper & Pesto Panini .....   | 6 |
| Zucchini ai Quattro Formaggi Panini .....                    | 7 |
| Pizza Panini .....   | 7 |
| Chicken Quesadilla Wraps .....                               | 8 |

## THE MAIN COURSE

|  |    |
|--|----|
| Not Fried Fish & Chips .....                         | 8  |
| The Best Hamburger .....                             | 9  |
| Shrimp Fajitas .....                                 | 10 |
| Saga Blue Stuffed Beef Fillets with Herb Crust ..... | 11 |
| Southwestern Spiced Grilled Rib Eye Steaks .....     | 11 |
| Herb Grilled Boneless Pork Chops .....               | 12 |
| Teriyaki Grilled Chicken .....                       | 13 |

## SIDE DISHES

|                                     |    |
|-------------------------------------|----|
| Potato & Gorgonzola Cakes .....     | 13 |
| Grilled Green Beans with Feta ..... | 14 |

## DESSERTS

|   |    |
|---|----|
| Cheese & Raisin Danish on Swirl Bread Panini .....  | 14 |
| Grilled Pound Cake with Cinnamon Glazed Pears ..... | 15 |

|  |       |
|--|-------|
| COOKING GUIDE AND FOOD TEMPERATURE CHART ..... | 16-17 |
|--|-------|



Cuisinart®



the GRIDDLE®  
a guide to perfect meals

Instruction  
Booklet  
Reverse Side



|   |                                      |
|---|--------------------------------------|
| Version no: GR4N IB-8999A   |                                      |
| Size : 140mm(W) X 216mm(H)  |                                      |
| Material: Cover:157gam Matt art paper, inside: 120gsm Gloss art paper |                                      |
| Coating: Cover:Glass varnishing                                       |                                      |
| Color (Front): 4C+1C(CMYK+PMS 8501C)                                  |                                      |
| (Back): 1C+1C(Black)  |                                      |
| Date: 02/02/2010  | Co-ordinator : Astor You / Scias Liu |
| XieFaXing Des cription : IB-8999A                                     | OPERATOR: Xu                         |
| XieFaXing Code : E-IB-8999A   |                                      |

