

PRORUN®

GAS///

Operator's Manual

STRING TRIMMER CURVE SHAFT

MODEL: PCST215

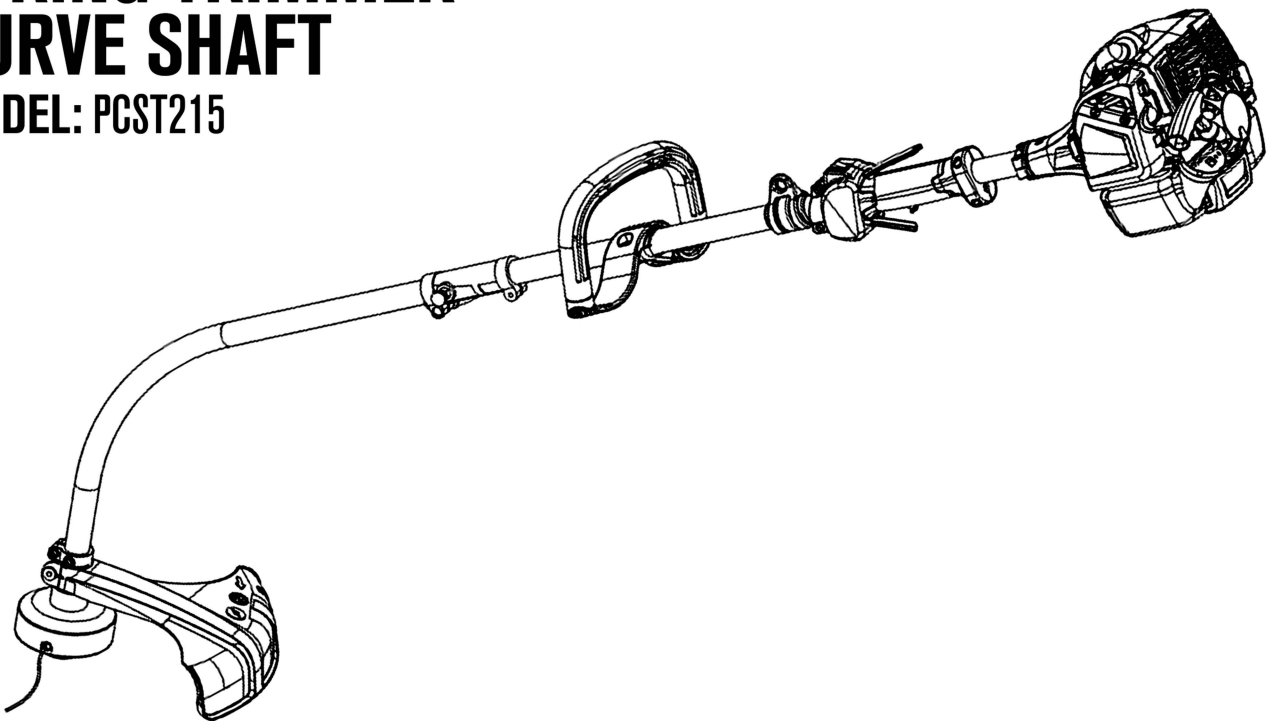

Before operating, read the instructions.

⚠ IMPORTANT - READ CAREFULLY BEFORE USE

⚠ IMPORTANT SAFETY INSTRUCTIONS - SAVE THESE INSTRUCTIONS



WARNING: To reduce the risk of injury, the user must read and understand the Operator's Manual before using this product. Save these instructions for future reference.

Please let us know what you think.
To leave a review and see our full line of products, visit:

proruntech.com ★ ★ ★ ★ ★





1-844-905-0882, info@proruntech.com
Version: B - Issue Date: 2023/07/25

Table of Content





Safety	2	Troubleshooting	20
Setup.....	9	Specification.....	22
Operation.....	11	Part List and Diagram.....	23
Maintenance.....	15	Warranties.....	27









Safety

WARNING SYMBOLS AND DEFINITIONS

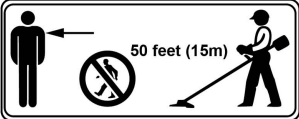
	This is the safety alert symbol. It is used to alert you to potential personal injury hazards. Obey all safety messages that follow this symbol to avoid possible injury or death.
	Indicates a hazardous situation which, if not avoided, will result in death or serious injury.
	Indicates a hazardous situation which, if not avoided, could result in death or serious injury.
	Indicates a hazardous situation which, if not avoided, could result in minor or moderate injury.
	Addresses practices not related to personal injury.

Symbol Definitions

Symbol	Property or Statement
	WARNING! The trimmer can be dangerous if used incorrectly or carelessly, and can cause serious or fatal injury to the operator or others. It is extremely important that you read and understand the contents of this owner's manual.
	WARNING! Read the operator's manual(s) and follow all warnings and safety instructions. Failure to do so can result in serious injury to the operator and/or bystanders.
	Always wear: <ul style="list-style-type: none"> • A protective helmet where there is a risk of falling object • Beware of thrown objects such as ricochet. Always wear eye protection that complies with ANSI Z87.1. Always wear hearing protection when operating the machine.
	Wear sturdy, non-slip boots.

Symbol	Property or Statement
	<p>Always wear approved protective gloves.</p>
	<p>Watch out for thrown objects and ricochets.</p>
	<p>Always keep bystanders at least 50 feet (15m) away when operating the machine.</p>
	<p>Do not use metal blades, use flexible cutting lines only.</p>
	<p>Fuel mixture tank.</p>
	<p>Close the choke. Open the choke.</p>
<p>H L T</p>	<p>The screw under the "H" stamp is The High-speed mixture adjustment screw. The screw under the "L" stamp is The Low-speed mixture adjustment screw. The screw up the "T" stamp is the idle speed adjustment screw.</p>
	<p>Operate the engine switch Flipping the switch to the "O" position, immediately the engine stops.</p>
	<p>An arrow indicating rotation direction of cutting attachment.</p>

IMPORTANT SAFETY INSTRUCTION



SAVE THESE INSTRUCTION

This manual contains important instructions that should be followed during setup, operation and maintenance of the string trimmer.

Set up Precautions

1. Gasoline fuel and fumes are flammable, and potentially explosive. Use proper fuel storage and handling procedures. Do not store fuel or other flammable materials nearby.

2. Have multiple ABC class fire extinguishers nearby.

3. Operation of this equipment may create sparks that can start fires around dry vegetation.

A spark arrestor may be required. The operator should contact local fire

agencies for laws or regulations relating to fire prevention requirements

4. Set up and use only on a flat, level, well-ventilated surface.

5. Wear ANSI-approved safety goggles, heavy-duty work gloves, and dust mask/respirator during use.

6. Use only lubricants and fuel recommended in the Specifications chart of this manual.

General Safety Instructions

⚠WARNING

To reduce the risk of fire, or injury:

1. Always hold the string trimmer with your right hand on the rear handle and your left hand on the front handle.

2. Personal Protective Equipment.

To reduce the risk of hearing loss associated with sound levels, hearing protection is required. To reduce the risk of injury associated with thrown objects, always wear eye protection. Eye protection should meet the requirements of ANSI Z87.1. To reduce the risk of injury associated with the inhalation of dust, use a face filter mask in dusty conditions.

3. Physical Condition of Operator.

Do not operate this unit when tired, ill, or under the influence of alcohol, drugs, or medication.

4. Clothing Recommendation.

Always wear heavy, long pants, boots, gloves, and a long-sleeve shirt. To reduce the risk of injury

associated with objects being drawn into rotating parts, do not wear loose clothing, scarves, jewelry, etc. Secure hair so it is above shoulder level.

5. Condition of Unit before Use.

Inspect unit before each use. Replace damaged parts. Check for fuel leaks. Make sure all fasteners are in place and secure. Replace cutting attachment parts that are cracked, chipped, or damaged in any way. Make sure the cutting attachment is properly installed and securely fastened. Be sure the cutting attachment shield is properly attached and in the position recommended by the manufacturer. Use only flexible, nonmetallic line recommended by the manufacturer. Never use, for example, wire or wire-rope, which can break off and become a dangerous projectile.

6. Proper Stance. Maintain firm footing and balance. Do not over-reach. Keep cutting attachment below waist level. Maintain all parts

of your body away from the rotating cutting attachment and hot surfaces.

7.Exhaust Gases. Do not operate the unit inside a closed environment, such as a room or building; breathing carbon monoxide from exhaust fumes can kill.

8.Fueling. Mix and pour fuel outdoors where there are no sparks and flames. Slowly remove the fuel cap only after stopping the engine. Do not smoke while fueling or mixing fuel. Wipe spilled fuel from the unit. Move at least 10 ft (3 m) away from the fueling source and site before starting engine.

9.Work Area. Clear the area to be cut before each use. Remove all objects such as rocks, broken glass, nails, wire, or string, which can be thrown or become entangled in the cutting attachment. Clear the area of children, bystanders and pets. At a minimum, keep all children, bystanders and pets outside a 50 ft (50 m) radius; outside the 50 ft (50 m) zone, there is still a risk of injury from thrown objects. Bystanders should be encouraged to wear eye protection. If you are approached, stop the engine and cutting attachment.

10.Idle Speed Adjustment. The cutting attachment may be spinning during carburetor adjustments. Wear your protective equipment and observe all safety instructions. For units equipped with a clutch, be sure the cutting attachment stops turning when the engine idles. When the unit is turned off, make sure the cutting attachment has stopped before the unit is set down.

11.Transportation and Storage of the Unit. The operator's manual

should provide transportation and long- and short-term storage instructions.

12.Service Work. To reduce the risk of injury associated with contacting rotating parts, stop the engine before installing or removing attachments. Do not operate without guards in place. Always disconnect the spark plug before performing maintenance or accessing movable parts.

13. Do not allow to be used as a toy. Close attention is necessary when used by or near children.

14. Use only as described in this manual. Use only manufacturer's recommended attachments.

15. If appliance is not working as it should, has been dropped, damaged, left outdoors, or dropped into water, return it to a service center.

16. Do not handle appliance with wet hands.

17. Keep hair, loose clothing, fingers, and all parts of body away from openings and moving parts.

18. Do Not Use In Rain.

19. Wear ANSI-approved safety goggles, hard hat and heavy-duty rubber work gloves.

20. Use Right Appliance - Do not use appliance for any job except that for which it is intended.

21. Avoid Unintentional Starting - Do not carry appliance with engine running.

22. Do Not Force Appliance - It will do the job better and with less likelihood of injury at the rate for which it was designed.

23. Do not Overreach - Keep proper footing and balance at all times.

24. Stay Alert - Watch what you are doing. Use common sense. Do not

operate appliance when you are tired.

25. Store Idle Appliances Indoors - When not in use, appliances should be stored indoors in dry, and high or locked-up place - out of reach of children.

26. Maintain Appliance With Care. Follow instructions for lubricating and changing accessories. Keep handles dry, clean, and free from oil and grease.

27. Check Damaged Parts - Before further use of the appliance, a guard or other part that is damaged should be carefully checked to determine that it will operate properly and perform its intended function. Check for alignment of moving parts, binding of moving parts, breakage of parts, mounting, and any other condition that may affect its operation. A guard or other part that is damaged should be properly repaired or replaced by a qualified technician unless indicated elsewhere in this

manual.

28. Remove all hard objects from work area.

29. Use only accessories provided. Keep guards in place and in working order.

30. Maintain labels and nameplates on the appliance. These carry important safety information. If unreadable or missing, contact dealer for a replacement.

31. People with pacemakers should consult their physician(s) before use. Electromagnetic fields in close proximity to heart pacemaker could cause pacemaker interference or pacemaker failure. The warnings, precautions, and instructions discussed in this instruction manual cannot cover all possible conditions and situations that may occur. It must be understood by the operator that common sense and caution are factors which cannot be built into this product, but must be supplied by the operator.

Operating Precautions

1. Keep children away from the equipment, especially while it is in use.

2. Keep all spectators at least fifteen feet from the Engine during operation.

3. Fire Hazard! Do not fill fuel tank while engine is running. Do not operate if gasoline has been spilled. Clean spilled gasoline before starting engine. Do not operate near pilot light or open flame.

4. Do not touch engine during use. Allow engine to cool down after use.

5. Never store fuel or other flammable materials near the engine.

6. Secure the equipment on transport vehicles to prevent it from rolling, slipping, and tilting.

7. Do not leave the equipment unattended when it is running. Turn off the equipment before leaving the work area.

8. The equipment can produce high

noise levels. Prolonged exposure to noise levels above 85 dBA is hazardous to hearing. Wear ear protection when operating or when working nearby while it is operating.

9. Wear ANSI-approved safety glasses and hearing protection during use.

10. People with pacemakers should consult their physician(s) before use. Electromagnetic fields in close proximity to a heart pacemaker could cause pacemaker interference or pacemaker failure. Caution is necessary when near the engine's magneto or recoil starter.

11. Use only accessories that are recommended by PRORUN Customer Service for your model.

Accessories that may be suitable for one piece of equipment may become hazardous when used on another piece of equipment.

12. Do not operate in explosive atmospheres, such as in the presence of flammable liquids, gases, or dust. Gasoline-powered engines may ignite the dust or fumes.

13. Stay alert, watch what you are doing and use common sense when operating this piece of equipment. Do not use while tired or under the influence of drugs, alcohol or medication.

14. Do not overreach. Keep proper footing and balance at all times. This enables better control of the equipment in unexpected situations.

15. Use this equipment with both hands only.

Using equipment with only one hand can easily result in loss of control.

16. Dress properly. Do not wear loose clothing or jewelry. Keep hair, clothing and gloves away from moving

parts. Loose clothes, jewelry or long hair can be caught in moving parts.

17. Parts, especially exhaust system components, get very hot during use. Stay clear of hot parts.

18. Do not cover the equipment during operation.

19. Keep the equipment, engine, and surrounding area clean at all times.

20. Do not smoke, or allow sparks, flames, or other sources of ignition around the equipment, especially when refuelling.

21. Use the equipment, accessories, etc., in accordance with these instructions and in the manner intended for the particular type of equipment, taking into account the working conditions and the work to be performed. Use of the equipment for operations different from those intended could result in a hazardous situation.

22. Do not operate the equipment with known leaks in the engine's fuel system.

23. When spills of fuel or oil occur, they must be cleaned up immediately. Dispose of fluids and cleaning materials as per any local, state, or federal codes and regulations. Store oil rags in a bottom-ventilated, covered, metal container.

24. Keep hands and feet away from moving parts.

Do not reach over or across equipment while operating.

25. Before use, check for misalignment or binding of moving parts, breakage of parts, and any other condition that may affect the equipment's operation. If damaged, have the equipment serviced before using. Many accidents are caused by

poorly maintained equipment.
26. Use the correct equipment for the application. Do not modify the

equipment and do not use the equipment for a purpose for which it is not intended.

Service Precautions

1. Before service, maintenance, or cleaning:
 - a. Turn the engine switch to its "OFF" position.
 - b. Allow the engine to completely cool.
 - c. Then, remove the spark plug cap from the spark plug.
2. Keep all safety guards in place and in proper working order. Safety guards include muffler, air cleaner, mechanical guards, and heat shields, among other guards.
3. Do not alter or adjust any part of the equipment or its engine that is sealed by the manufacturer or distributor. Only a qualified service technician may adjust parts that may increase or decrease governed engine speed.
4. Wear ANSI-approved safety goggles, heavy-duty work gloves, and dust mask/respirator during service.
5. Maintain labels and nameplates on the equipment. These carry important information. If unreadable or missing, contact dealer for a replacement.
6. Have the equipment serviced by a qualified repair person using only identical replacement parts. This will ensure that the safety of the equip-

- ment is maintained. Do not attempt any service or maintenance procedures not explained in this manual or any procedures that you are uncertain about your ability to perform safely or correctly.
7. Store equipment out of the reach of children.
 8. Follow scheduled engine and equipment maintenance.

Refueling:

1. Do not refill the fuel tank while the engine is running or hot.
2. Do not smoke, or allow sparks, flames, or other sources of ignition around the equipment, especially when refuelling.
3. Do not fill fuel tank to the top. Leave a little room for the fuel to expand as needed, at least 1" from top of the neck.
TO PREVENT FUEL LEAKAGE AND FIRE HAZARD, do not fill fuel above the bottom of the threads.
4. Refuel in a well-ventilated area only.
5. Wipe up any spilled fuel and allow excess to evaporate before starting engine. To prevent FIRE, do not start the engine while the smell of fuel hangs in the air.

Set Up

 Read the **ENTIRE IMPORTANT SAFETY INFORMATION** section at the beginning of this manual including all text under subheadings therein before set up or use of this product.

WARNING

TO PREVENT SERIOUS INJURY:

Operate only with proper spark arrestor installed.



Operation of this equipment may create sparks that can start fires around dry vegetation.

A spark arrestor may be required.

The operator should contact local fire agencies for laws or regulations relating to fire prevention requirements.

Components and Controls

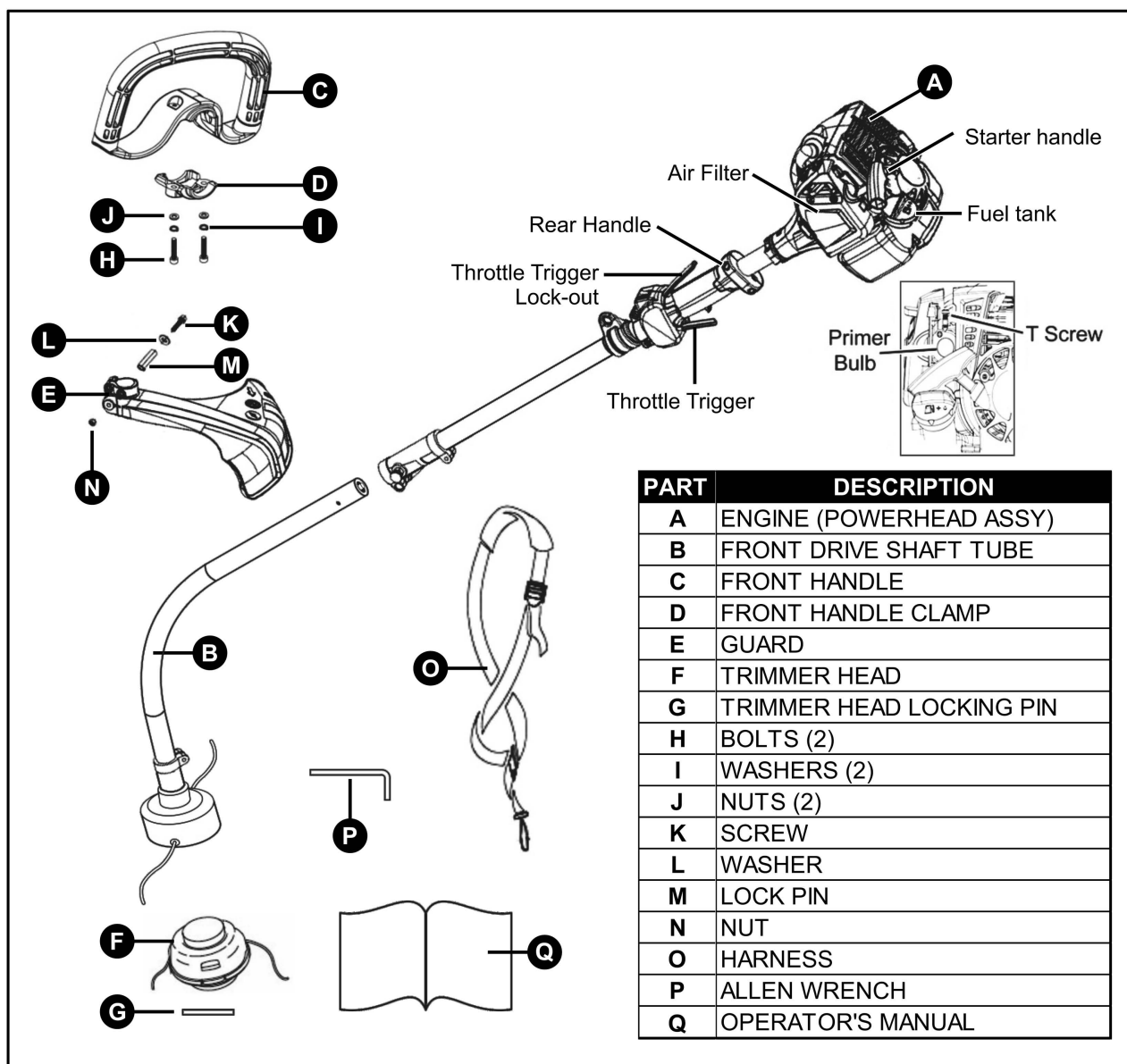

Installing the Handle

Align the pin on front handle with the one of three holes on the tube. Put the front handle on the tube between the connector and the rear handle.

The clamp is installed on the tube. And fix the front handle and clamp with two screws.

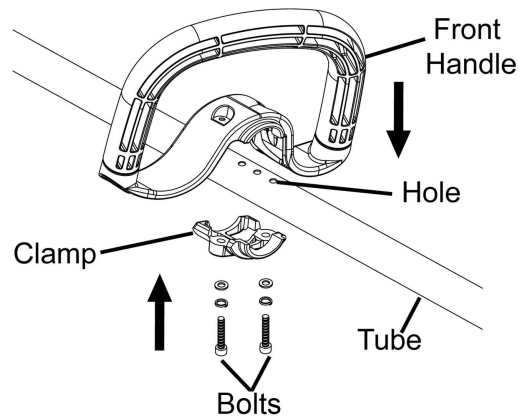

Installing the Tube

Align the hole on the front drive shaft tube and lock pin. Then, Pull out the Lock pin, and while inserting the front tube in the connector to the end. After loosened the lock pin, it will return to its original position automatically, and insert into the hole on the front tube.

Make sure the front tube can't be rotated after the lock pin came back to its original position. Turn the lock knob clockwise to tighten the front tube securely.

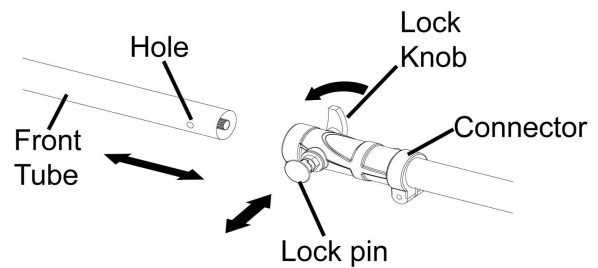

Installing the Guard

Insert the guard into the front drive shaft tube and fix it firmly with screw, pin, and nut.

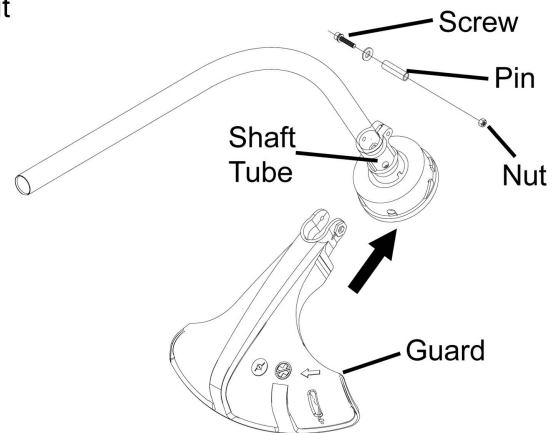

Installing the Trimmer Head

Turn the blade shaft until one of the holes in the top clamping plate aligns with the corresponding hole in the top protecting cap. Insert the locking pin in the hole to lock the shaft.

Screw on the trimmer head in the direction of rotation.

To dismantle, follow the instructions in the reverse order.

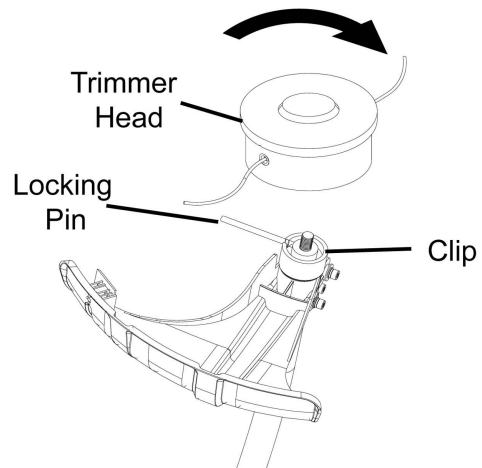

Operation

 Read the **ENTIRE IMPORTANT SAFETY INFORMATION** section at the beginning of this manual including all text under subheadings therein before set up or use of this product.

Checking before Starting

Inspect engine and equipment looking for damaged, loose, and missing parts before set up and starting. If any problems are found, do not use equipment until fixed properly.

Checking and Filling Fuel



 **WARNING! TO PREVENT SERIOUS INJURY FROM FIRE:**

Fill the fuel tank in a well-ventilated area away from ignition sources. If the engine is hot from use, shut the engine off and wait for it to cool before adding fuel. Do not smoke.

1. Clean the Fuel Tank Cap and the area around it.
2. Unscrew and remove the Fuel Tank Cap.
Note: Do not use gasoline containing more than 10% ethanol (E10). Do not use E85 ethanol. Add fuel stabilizer to the gasoline or the Warranty is VOID.

Note: Do not use gasoline that has been stored in a metal fuel container or a dirty fuel container. It can cause particles to enter the carburetor, affecting engine performance and/or causing damage.

IMPORTANT: Your Warranty is VOID if the Engine's Fuel Tank is not filled with the proper mixture (50:1) of unleaded gasoline and 2-cycle oil before each use.

2-Stroke oil must meet either JASO M345 FD or ISO-L-EGD requirements for air-cooled engines, synthetic.

Before each use, check the fuel level. Do not run the Engine with an improper unleaded gasoline/2-cycle oil mixture. Running the Engine with an improper mixture WILL permanently damage the Engine.

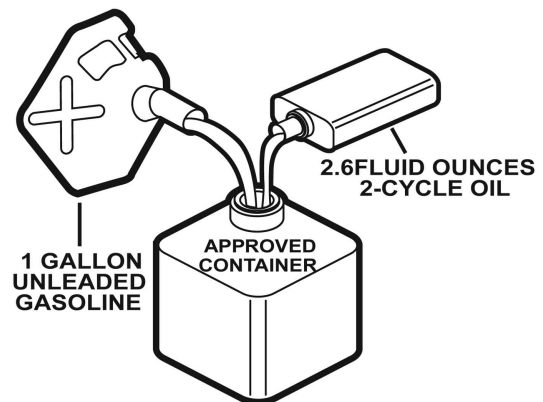

3. To obtain the proper gasoline and 2-cycle oil mixture, mix **2.6 fluid ounces of 2-cycle oil with 1 gallon of unleaded gasoline** into an approved container. Then gently agitate the container to thoroughly mix the gasoline/2-cycle oil.
4. If needed, fill the Fuel Tank to about 1 inch under the fill neck of the Fuel Tank with the pre-mixed unleaded gasoline/2-cycle oil mixture.
5. Then replace the Fuel Tank Cap.
6. Wipe up any spilled fuel and allow excess to evaporate before starting engine. To prevent FIRE, do not start the engine while the smell of fuel hangs in the air.

Starting the Engine

Before Starting the Engine

Before starting the engine:



- a. Inspect the equipment and engine.
- b. Fill the engine with the proper amount and type of unleaded gasoline and 2-cycle oil mixture.

Manual Start

A “cold start” is when the engine is no longer hot to the touch, typically at least 30 minutes after it has last been run.

1. Set the engine switch lever at the position “I”.

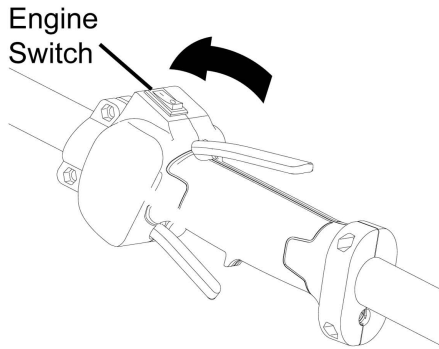

2. Press Primer Bulb 10 times to prime the carburetor.

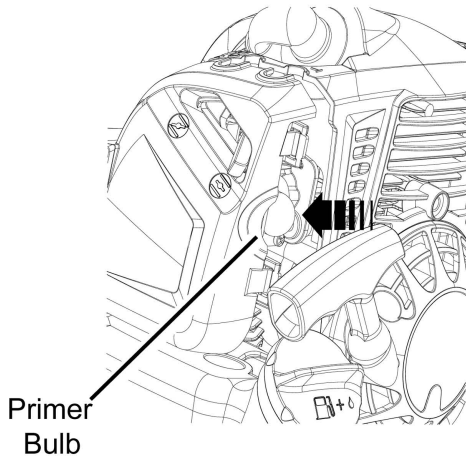

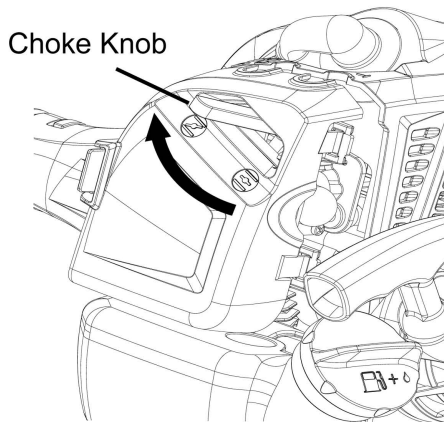

3. Move Choke Knob to the  position.
Note: The symbols below are indicated on the tool near the Choke Knob.

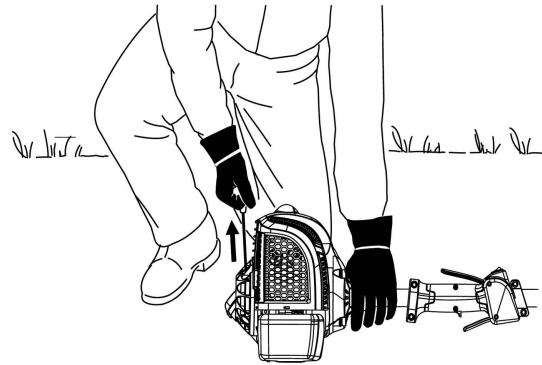

4. Use one hand to securely hold the unit against the ground.
5. Grip the Starter Handle of the Engine firmly and pull it rapidly until the engine attempts to

start and stalls.



6. Move the Choke Knob to the  position. This will partially engage the Throttle to assist with starting. The trimmer head will begin rotating immediately when the engine is starting.

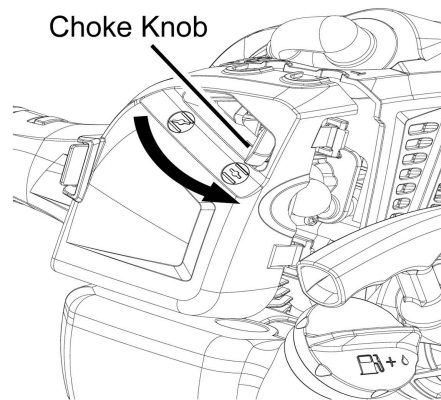

7. Pull the Starter Handle rapidly until the engine starts.

Note: Do not let the Starter Handle snap back against the engine.

8. Allow the Engine to run at partial throttle for 15 seconds.

9. Quickly press and then release Throttle to disengage Throttle Assist mode and allow the Engine to return to idle.

Note: Press the throttle too fast could stall engine.

10. Allow Engine to warm up at idle for 60 seconds before using so that the Engine can stabilize.

11. Adjust the Throttle as needed.

Hot Start

To initiate a Hot Start, follow each step of the Cold Start procedure EXCEPT Step 5.

Stopping the Engine

1. To stop the engine in an emergency, set the engine switch at "O" position to shut the engine off immediately.
2. Under normal conditions, use the following procedure:
 - a. Release the Throttle.
 - b. Let Engine idle for 1 – 2 minutes.
 - c. Press the Stop Engine Switch.

NOTICE

See Long-Term Storage on page 18 for complete storage instructions.

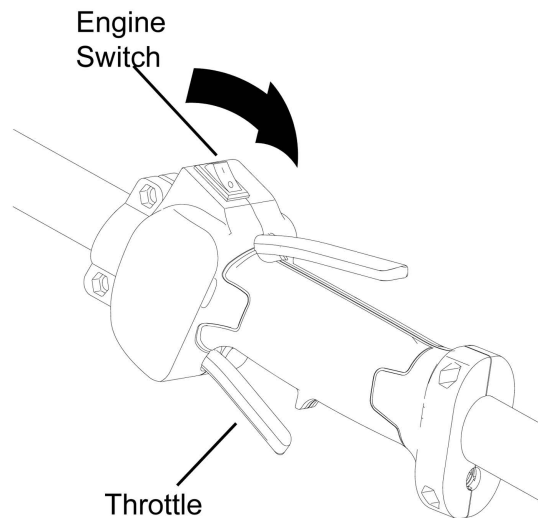

General Operating Instructions

Always slow the engine to idle speed after each working operation. Long periods at full throttle without any load on the engine can lead to serious engine damage.

IMPORTANT: Sometimes branches or grass get caught between the guard and cutting attachment. Always stop the engine before cleaning.

1. Trimming

Hold the trimmer head just above the ground at an angle. It is the end of the cutting line that does the work. Let the cutting line work at its own pace. Never press the cutting line into the area to be cut.

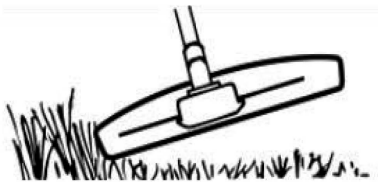

The cutting line can easily remove grass and weeds up against walls, fences, trees and borders, however it can also damage sensitive bark on trees and bushes, and damage fence posts. Reduce the risk of damaging plants by shortening the cutting line to 4 - 5 inches (10 - 12 cm) and reducing the engine.

2. Clearing

The clearing technique removes all unwanted vegetation. Keep the trimmer head just above the ground and tilt it. Let the end of the cord strike the ground around trees, posts, statues and the like.

IMPORTANT: This technique increases the wear on the cutting line

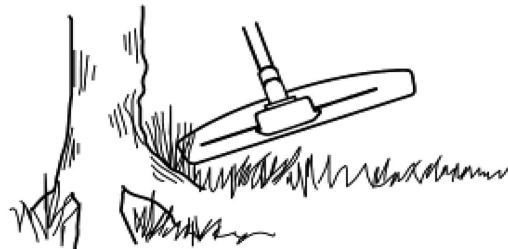

The cutting line wears quicker and must be fed forward more often when working against stones, brick, concrete, metal fences, etc., than when coming into contact with trees and wooden fences.

When trimming and clearing you should use less than full throttle so that the cord lasts longer and to reduce the wear on the trimmer head.

3. Cutting

The trimmer is ideal for cutting grass that is

difficult to reach using a normal lawn mower. Keep the cutting line parallel to the ground when cutting. Avoid pressing the trimmer head against the ground as this can ruin the lawn and damage the tool.

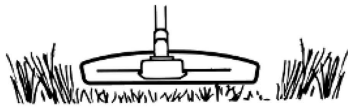

Do not allow the trimmer head to constantly come into contact with the ground during normal cutting. Constant contact of this type can cause damage and wear to the trimmer head.

4. Sweeping

The fan effect of the rotating cutting line can be used for quick and easy clearing up. Hold the cord parallel to and above the area to be swept and move the tool to and fro.

When cutting and sweeping you should use full throttle to obtain the best results.



5. Bump Feed

Note: Trimmer features a bump feed mechanism to adjust line length after repeated use.

1. Adjust length of the cutting line by bumping the trimmer head against the ground during operation.

2. The cutting line will lengthen slightly the next time the trimmer is used. Excess cutting line will be cut off by the blade in the guard.

6. Using the Throttle Trigger Lock-out

Note: The Throttle Trigger Lock-out lever is located on the Handle, just opposite the Throttle Trigger.

1. Grasp the Handle and press down on the Throttle Release to enable Throttle Trigger for use.

2. Keep Throttle Trigger Lock-out lever engaged while operating the Throttle Trigger.

7. Trimmer Operation

NOTICE: To prevent damage to tool or property, avoid contact with fences, trees, shrubs and the like.

a. Holding Trimmer with both hands, press Throttle Trigger Lock-out lever then press Throttle Trigger

b. DO NOT REST TRIMMER ON GROUND.

c. Do not force the Trimmer. Use the tip of the cutting line do the cutting.

d. Release Throttle Trigger when done.

e. When finished, to prevent accidents:

Wipe external surfaces of the appliance with clean cloth. Store in an indoor dry area out of reach of children.

Maintenance

WARNING

WARNING TO PREVENT SERIOUS INJURY FROM ACCIDENTAL STARTING:

Turn the Power Switch of the equipment to its “OFF” position, wait for the engine to cool, and disconnect the spark plug cap before performing any inspection, maintenance, or cleaning procedures.

TO PREVENT SERIOUS INJURY FROM EQUIPMENT FAILURE:

Do not use damaged equipment. If abnormal noise, vibration, or excess smoking occurs maintenance procedures, including any not detailed in this manual, will need to be performed by a qualified technician for safety. If you have any doubts about your ability to safely service the equipment or engine, have a PRORUN authorized technician service the equipment instead.



Cleaning, Maintenance, and Lubrication

Note: This maintenance schedule is intended solely as a general guide. If performance decreases or if equipment operates unusually, check systems immediately. The maintenance needs of each piece of equipment will differ depending on factors such as duty cycle, temperature, air quality, fuel quality, and other factors. If you have doubts about your ability to safely service this tool, have a PRORUN authorized technician service the equipment instead.

Note: The following procedures are in addition to the regular checks and maintenance explained as part of the regular operation of the engine and equipment.

Procedure	Before Each Use	Monthly or every 10 hr. of use	Every 3 mo. or 20 hr. of use	Every 6 mo. or 50 hr. of use	Yearly or every 100 hr. of use	Every 2 Years
Brush off outside of engine	✓					
Check engine fuel/oil mixture level	✓					
Change fuel filter					✓	✓
Clean air filter			✓*	✓	✓	✓
Check and clean spark plug				✓	✓	✓
Check/adjust idle speed	✓					
1. Clean fuel tank and carburetor 2. Clean carbon build-up from combustion chamber					✓**	✓**
Replace fuel line if necessary						✓**

* Service more frequently when used in dusty areas.

** Contact PRORUN Customer Service. These items should be services by an authorized service technician.

Checking and Filling Fuel



⚠ WARNING! TO PREVENT SERIOUS INJURY FROM FIRE:

Fill the fuel tank in a well-ventilated area away from ignition sources. If the engine is hot from use, shut the engine off and wait for it to cool before adding fuel. Do not smoke.

1. Clean the Fuel Tank Cap and the area around it.
2. Unscrew and remove the Fuel Tank Cap.

Note: Do not use gasoline containing more than 10% ethanol (E10). Do not use E85 ethanol. Add fuel stabilizer to the gasoline or the Warranty is VOID.

Note: Do not use gasoline that has been stored in a metal fuel container or a dirty fuel container. It can cause particles to enter the carburetor, affecting engine performance and/or causing damage.

IMPORTANT: Your Warranty is VOID if the Engine's Fuel Tank is not filled with the proper mixture (50:1) of unleaded gasoline and 2-cycle oil before each use.

2-Stroke oil must meet either JASO M345 FD or ISO-L-EGD requirements for air-cooled engines, synthetic.

Before each use, check the fuel level. Do not run the Engine with an improper unleaded gasoline/2-cycle oil mixture. Running the Engine with an improper mixture WILL permanently damage the Engine.

3. To obtain the proper gasoline and 2-cycle oil mixture, mix **2.6 fluid ounces of 2-cycle oil with 1 gallon of unleaded gasoline** into an approved container. Then gently agitate the container to thoroughly mix the gasoline/2-cycle oil.

4. If needed, fill the Fuel Tank with the pre-mixed unleaded gasoline/2-cycle oil mixture. Do not fill fuel above the bottom of the Fuel Tank fill neck.

5. Then replace the Fuel Tank Cap.

6. Wipe up any spilled fuel and allow excess to evaporate before starting engine. To prevent

FIRE, do not start the engine while the smell of fuel hangs in the air.

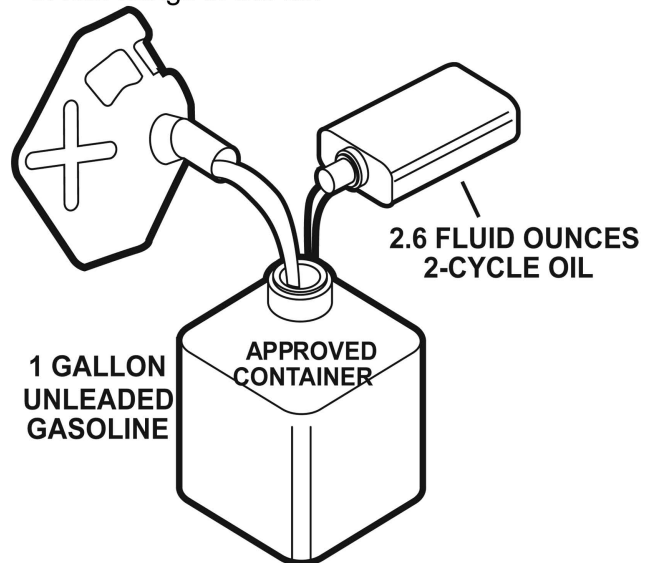

Spark plug Maintenance

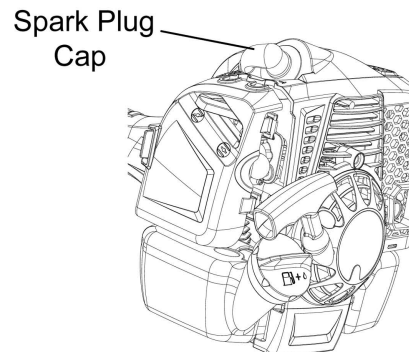

1. Disconnect Spark Plug Cap from end of plug. Clean out debris from around Spark Plug.

2. Using a spark plug wrench, remove the Spark Plug.

3. Inspect the Spark Plug: If the electrode is oily, clean it using a clean, dry rag. If the electrode has deposits on it, polish it using emery paper. If the white insulator is cracked or chipped, the spark plug needs to be replaced.

Recommended Spark Plugs	
Bosch®	L8RTF
Champion®	RCJ7Y
TORCH®	L7RTC
NGK®	BPMR7A

NOTICE: Using an incorrect spark plug may damage the engine.

4. When installing a new spark plug, adjust the plug's gap to the specification on the Specifications chart. Do not pry against the

Specifications chart. Do not pry against the electrode, the spark plug can be damaged.

5. Install the new spark plug or the cleaned spark plug into the engine.

• **Gasket-style:**

Finger-tighten until the gasket contacts the cylinder head, then tighten about 1/2-2/3 turn more.

• **Non-gasket-style:**

Finger-tighten until the plug contacts the cylinder head, then tighten about 1/16 turn more.

NOTICE: Tighten the Spark Plug properly. If loose, the Spark Plug will cause the engine to overheat.

If overtightened, the threads in the engine block will be damaged.

6. Apply dielectric spark plug boot protector (not included) to the end of the spark plug and reattach the cap securely.

Air Filter Maintenance

1. Remove the Air Filter Cover and the Air Filter and check for dirt. Clean or replace as described below.

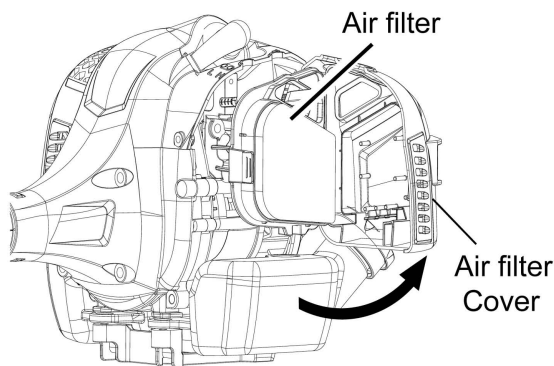

2. To prevent injury from dust and debris, wear ANSI-approved safety goggles, NIOSH-approved dust mask/respirator, and heavy-duty work gloves. Remove dust on the Filter surface by tapping a corner of the Filter against a hard surface. In a well-ventilated area away from bystanders, use pressurized air to blow dust out of the Filter from the inside.

3. Install the new or cleaned filter. Reinstall and secure the Air Filter Cover before use.

Fuel Filter Maintenance

1. Clean the Fuel Tank Cap and the area around it.

2. Remove the Fuel Tank Cap from the Fuel Tank.

3. Use a suction pump (not included) to pump any fuel in the Tank into a proper gasoline container.

4. Use a piece of wire with a hook on one end to carefully extract the Fuel Filter from the Tank.

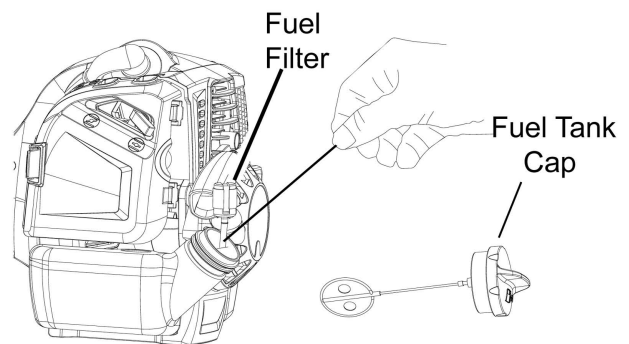

5. Remove used filter from fuel line. Attach a new filter to the fuel line and reinsert into the Fuel Tank.

6. Replace Fuel Tank Cap and tighten securely.

Install The Cutting Line

1. Press the two spool tabs on the spool cover with two fingers, and separate the buckle cover from the trimmer head with the other hand.

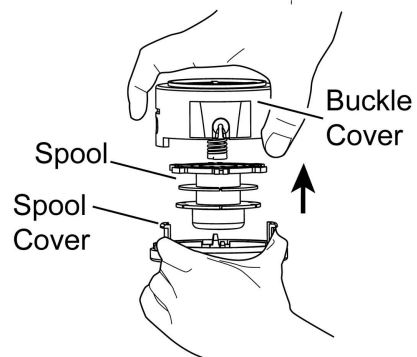

2. Take off the spool. Remove any remaining line.

3. Clean dirt and debris from all parts. Replace spool if it is worn or damaged.

4. Fold the new cutting line in half so that both sides of the rope are the same length.

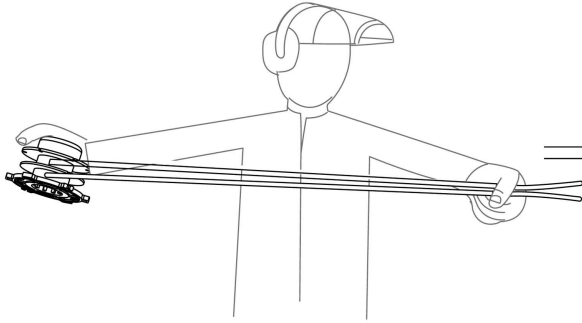

6. Put the spool of the line back into the spool cover.

Put the line into the groove.

Align the spool tabs with the tab openings in the base of the spool.

Push the spool cover until it clicks into position.

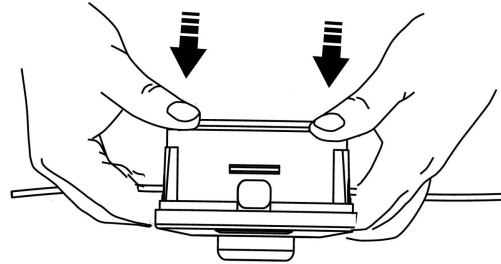

5. Clip the double point of the line into the spool and anticlockwise around the spool.

NOTE: Do not put more than 13 feet of cutting line in at a time.

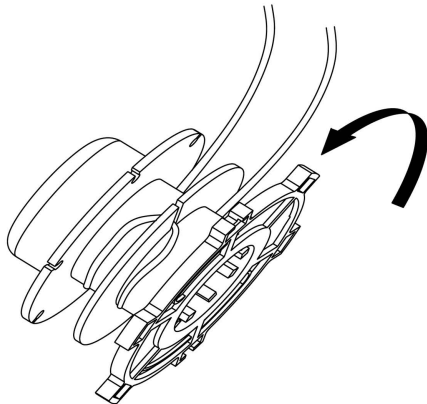

Long-Term Storage

When the equipment is to remain idle for longer than 20 days, prepare the Engine for storage as follows:

1. CLEANING:

Wait for Engine to cool, then clean Engine with dry cloth. **NOTICE: Do not clean using water.** The water will gradually enter the Engine and cause rust damage. Apply a thin coat of rust preventive oil to all metal parts.

2. FUEL:

To protect the fuel system during storage,

follow this procedure:

- Carefully drain any remaining fuel in the fuel tank into an appropriate storage container.
- Press the Primer Bulb 10 times.
- Drain any residual fuel into storage container.
- Start the string trimmer.
- Allow engine to run at idle until string trimmer stalls from lack of fuel.
- Replace Fuel Cap and tighten.



⚠ WARNING! TO PREVENT SERIOUS INJURY FROM FIRE:

Drain the Fuel Tank in a well-ventilated area away from ignition sources. If the Engine is hot from use, shut the Engine off and wait for it to cool before draining fuel. Do not smoke.

3.LUBRICATION:

a.Clean out area around spark plug. Remove spark plug and pour 1/2 tablespoon of 2-stroke engine oil into cylinder through spark plug hole.

b.Replace spark plug, but leave spark plug cap disconnected.

c.Pull Starter Handle to distribute oil in

cylinder. Stop after one or two revolutions when you feel the piston start the compression stroke (when you start to feel resistance).

4.STORAGE AREA:

Cover and store in a dry, level, well-ventilated area out of reach of children. Storage area should also be away from ignition sources, such as water heaters, clothes dryers, and furnaces.

5.AFTER STORAGE:

Before starting the Engine during or after storage, keep in mind that untreated gasoline will deteriorate quickly. Change to fresh fuel if untreated gasoline has been sitting for a month, if treated gasoline has been sitting beyond the fuel stabilizer's recommended time period, or if the Engine does not start.

Troubleshooting

Problem	Possible Causes	Probable Solutions
Engine will not start	<p>FUEL RELATED:</p> <ol style="list-style-type: none"> 1.No fuel in tank. 2.Choke not in START position, cold engine. 3. Gasoline with more than 10% ethanol used. (E15, E20, E85, etc.) 4.Low quality or deteriorated, old gasoline/oil mixture. 5.Carburetor not primed. 6.Dirty fuel passageways. 7.Carburetor is flooded. 8.Clogged Fuel Filter. 	<p>FUEL RELATED:</p> <ol style="list-style-type: none"> 1.Fill fuel tank with fresh 87+ octane stabilizer-treated unleaded gasoline/oil mixture only. Do not use gasoline with more than 10% ethanol (E15, E20, E85, etc.). 2.Move Choke to START position. 3.Clean out ethanol-rich gasoline from fuel system. Replace components damaged by ethanol. Use fresh 87+ octane stabilizer-treated unleaded gasoline/oil mixture only. Do not use gasoline with more than 10% ethanol (E15, E20, E85, etc.). 4.Use fresh 87+ octane stabilizer-treated unleaded gasoline/oil mixture. Do not use gasoline with more than 10% ethanol (E15, E20, E85, etc.). 5.Press the Primer Bulb several times to prime. 6.Clean out passageways using fuel additive. Heavy deposits may require further cleaning. 7.Turn Choke Knob to RUN position. Pull Starter Handle 10-20 times to clear out Carburetor, then attempt to start with normal process. 8.Clean or replace Fuel Filter.
	<p>IGNITION (SPARK) RELATED:</p> <ol style="list-style-type: none"> 1.Spark plug cap not connected securely. 2.Spark plug electrode wet or dirty. 3.Incorrect spark plug gap. 4.Spark plug cap broken. 5.Incorrect spark timing or faulty ignition system. 	<p>IGNITION (SPARK) RELATED:</p> <ol style="list-style-type: none"> 1.Connect spark plug cap properly. 2.Clean spark plug. 3.Correct spark plug gap. 4.Replace spark plug cap. 5.Contact PRORUN Customer Service and have an approved technician diagnose/repair ignition system.
	<p>COMPRESSION RELATED:</p> <ol style="list-style-type: none"> 1.Cylinder not lubricated. Problem after long storage periods. 2.Loose or broken spark plug. (Hissing noise will occur) 	<p>COMPRESSION RELATED:</p> <ol style="list-style-type: none"> 1.Pour 1/2 tablespoon of oil into spark plug hole. Crank engine a few times and try to start again. 2.Tighten spark plug. If that does not work, replace spark plug.



Follow all safety precautions whenever diagnosing or servicing the equipment or engine.

Problem	Possible Causes	Probable Solutions
Engine misfires	1. Spark plug cap loose. 2. Incorrect spark plug gap or damaged spark plug. 3. Defective spark plug cap. 4. Old or low quality gasoline/oil mixture. 5. Incorrect compression.	1. Check cap and wire connections. 2. Re-gap or replace spark plug. 3. Replace spark plug cap. 4. Use only fresh 87+ octane stabilizer-treated unleaded gasoline/oil mixture. Do not use gasoline with more than 10% ethanol (E15, E20, E85, etc.). 5. Diagnose and repair compression. (Use Engine will not start: COMPRESSION RELATED section.)
Engine stops suddenly	1. Fuel tank empty or full of impure or low quality gasoline/oil mixture. 2. Defective breather valve creating vacuum, preventing proper fuel flow. 3. Faulty magneto. 4. Disconnected or improperly connected spark plug cap.	1. Fill fuel tank with fresh 87+ octane stabilizer-treated unleaded gasoline/oil mixture. Do not use gasoline with more than 10% ethanol (E15, E20, E85, etc.). 2. Test/replace breather valve. 3. Contact PRORUN Customer Service and have an approved technician service magneto. 4. Secure spark plug cap.
Engine stops when under heavy load	1. Dirty air filter 2. Engine running cold.	1. Clean element. 2. Allow engine to warm up prior to operating equipment.
Engine knocks	1. Old or low quality gasoline/oil mixture. 2. Engine overloaded. 3. Incorrect spark timing, deposit buildup, worn engine, or other mechanical problems.	1. Fill fuel tank with fresh 87+ octane stabilizer-treated unleaded gasoline/oil mixture. Do not use gasoline with more than 10% ethanol (E15, E20, E85, etc.). 2. Do not exceed equipment's load rating. 3. Contact PRORUN Customer Service and have an approved technician diagnose and service engine.



Follow all safety precautions whenever diagnosing or servicing the equipment or engine.

Specifications.

Displacement		25.4cc
Engine Type		Single Cylinder 2-stroke
Power Output		1 HP / 0.75 kW
Cooling System		Forced air cooled
Fuel	Type	87+ octane stabilizer-treated unleaded gasoline containing no more than 10% ethanol (E10) with 2-Stroke oil (see below)
	Capacity	20.3 fl. oz.
Oil	Type	2-Stroke oil must meet either JASO M345 FD or ISO-L-EGD requirements for air-cooled engines, synthetic
	Ratio	50:1 gasoline-to-oil ratio 2.6 oz oil per gallon of gasoline
Bore x Stroke		34mm x 28mm
Compression Ratio		6.9:1
Spark Plug	Type	Champion® RCJ7Y / Bosch® L8RTF NGK® BPMR7A / TORCH® L7RTC
	Gap	0.02 inch
Speed	Idle	3100±400RPM
	Maximum	8500RPM
Rotation viewed from PTO (power takeoff - the output shaft)		Counterclockwise
Sound Level at 50 feet		80 dB
Run Time @ full throttle		1 hr.
Cutting Diameter		15 inches (381 mm)
Replacement Line Type		0.080 or 0.095 inch Nylon

Parts List and Diagram

Part List - Trimmer

NO.	Description	Qty
1	sleeve 26	1
2	clamp	1
3	nut M5	1
4	screw M5x22	1
5	harness clamp assembly	1
6	back shaft assembly	1
7	back AL tubing	1
8	rubber\ shaft	3
9	connector assembly	1
10	screw M5x25	1
11	screw M5x12	1
12	screw M6x50	1
13	plate washer 6	1
14	locking knob	1
15	nut M6	1
16	bolt	1
17	spring washer	1
18	plastic liner	1
19	curve tubing	1
20	screw M5x40	1
21	plate washer 5x16x1	1
22	over set	1
23	plastic guard	1
24	nut M5	1
25	cutting blade	1
26	ST screw 4.2x13	2
27	string head assembly	1
28	connector	1
29	screw M5x12	1
30	screw M5x25	1
31	eyelet	1
32	flex shaft	1
33	front handle	1
34	nut M5	2
35	handle base	1
36	clamp	1
37	screw M5x28	2
38	lock washer 5	2
39	plate washer 5	2

NO.	Description	Qty
40	plate washer 5	1
41	plate washer	1
42	ST screw 4.8x19	2
43	driver shaft	1
44	nut M5	4
45	plastic handle \ LH	1
46	spring \ trigger	1
47	wire cable A	1
48	wire cable B	1
49	bushing	1
50	throttl cable assembly	1
51	plastic handle \ RH	1
52	screw M5x14	2
53	ST screw 3.5x9.5	2
54	ST screw ST4.2x10	2
55	screw M5x14	2
56	trigger	1
57	switch	1
58	lock trigger	1
59	spring \ trigger	1
60	rear handle	1

Assembly Diagram - Trimmer

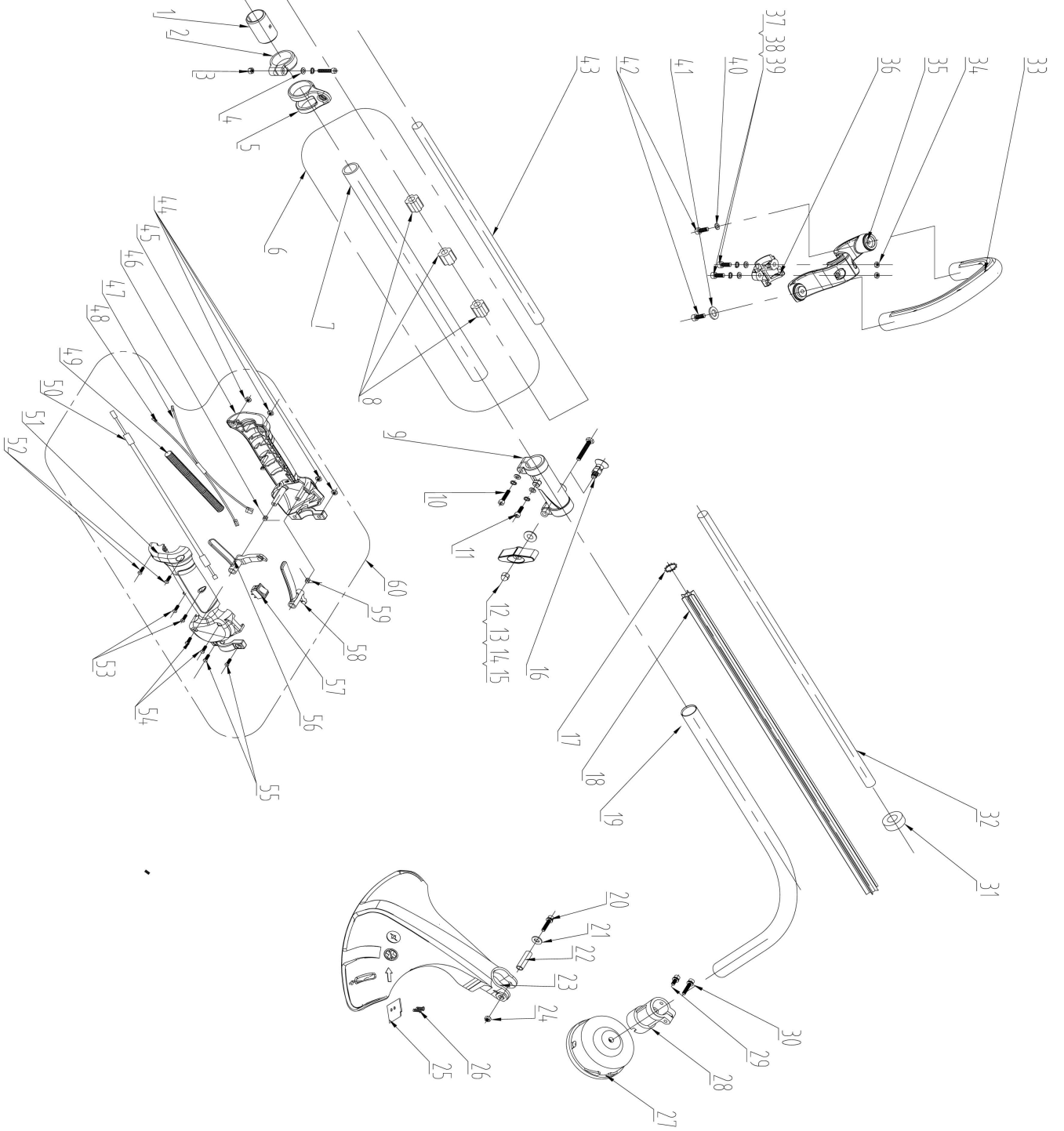

Part List - Engine

NO.	Description	Qty
1	screw M5x12	3
2	eyelet	1
3	start cover	1
4	starter assembly	1
5	start rope	1
6	start grip	1
7	coil spring	1
8	start pulley	1
9	spring. Start	1
10	ratchet wheel	1
11	plate washer	1
12	ST screw 4.8x16	1
13	start reel	1
14	washer 8	1
15	OIL-SEAL 12x22x7	1
16	crank case RH side	1
17	gasket \ crank case	1
18	bearing 6001	2
19	crank shaft assembly	1
20	key 3x3.5x10	1
21	bearing 6001 8x11x11	1
22	circlip \ Piston pin	2
23	piston pin	1
24	piston	1
25	piston ring	2
26	gasket \ cylinder	1
27	cylinder	1
28	screw M5x20	4
29	Spark Plug	1
30	ST screw 4.2x10	2
31	air deflector	1
32	top housing	1
33	ST screw 4.8x16	1
34	wire	1
35	Spark Plug cover	1
36	ignition	1
37	screw M5x20	2
38	pin ϕ 5x10	2
39	crank case LH side	1
40	screw M5x25	3
41	OIL-SEAL 12x22x7	1
42	magneto rotor	1
43	flange nut M8x1	1
44	flat washer	2
45	clutch assembly	1
46	elastic washer M8	2
47	bolt \ clutch	2

NO.	Description	Qty
48	pin ϕ 4x10	2
49	fan cover	1
50	screw M5x20	4
51	passive disk	1
52	circlip 35	1
53	bearing 6202	1
54	circlip 15	1
55	clutch drum housing	1
56	screw M6x20	4
57	rubber	1
58	clamp RH	1
59	clamp LH	1
60	screw M5x25	2
61	screw M5x12	1
62	screw M5x52	2
63	muffler heat shield	1
64	muffler	1
65	gasket \ muffler	1
66	gasket \ muffler	1
67	screw M4x12	2
68	gasket	1
69	admitting pipe	1
70	stamping	1
71	screw M4x6	1
72	screw M5x20	2
73	gasket \ carburetor	1
74	carburetor	1
75	air box assembly	1
76	air box base	1
77	screw M5x45	2
78	spone	1
79	air box cover	1
80	fuel tank cover	1
81	gasket rubber	1
82	anti falling board	1
83	fuel tank	1
84	rubber bump	4
85	fuel tank housing	1
86	screw M5x25	4
87	balancer	1
88	air tube	1
89	fuel tube	1
90	return tube	1
91	retainer . fuel tube	1
92	snap ring	1
93	filter fuel	1

Assembly Diagram - Engine

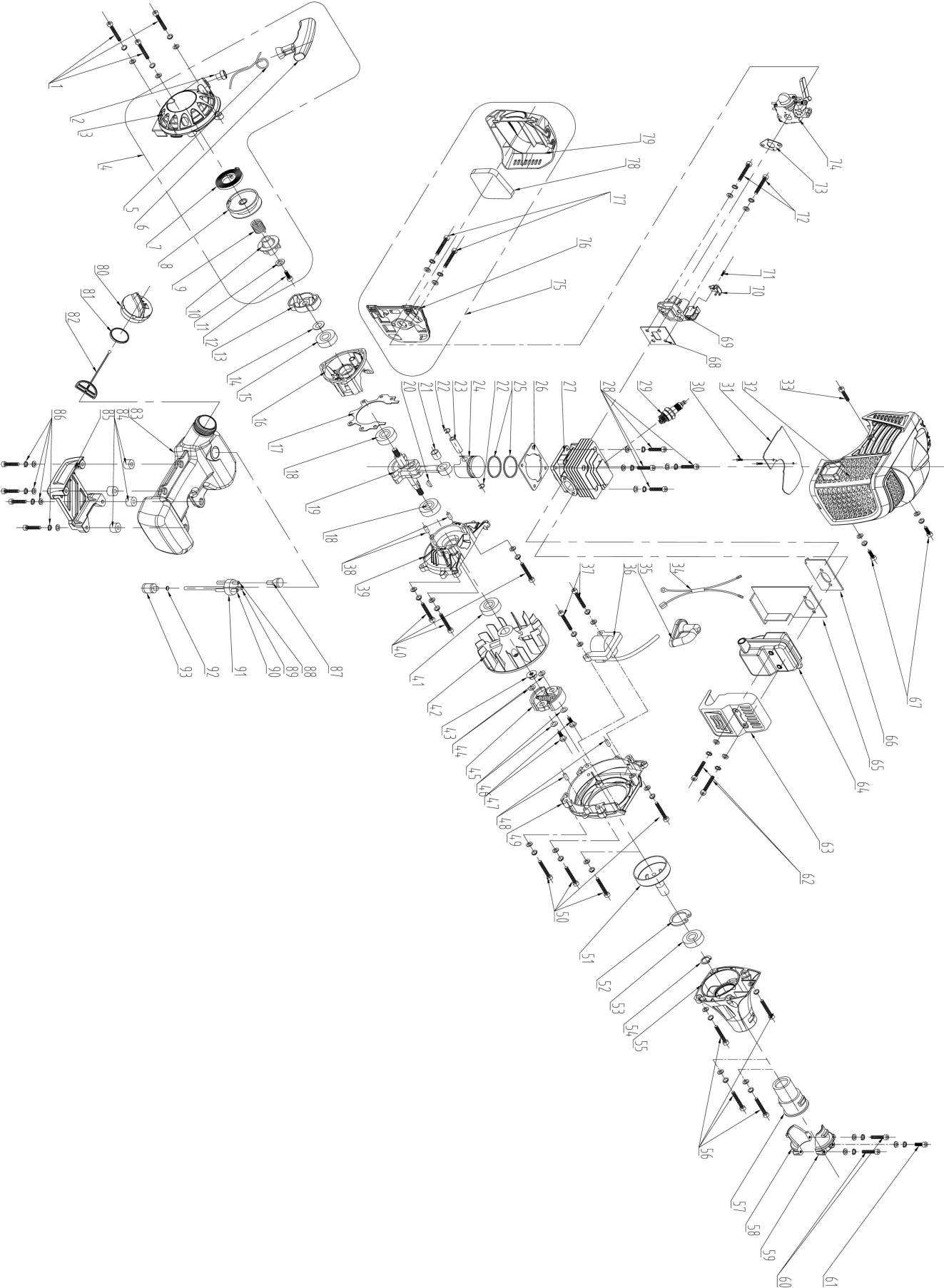

Warranties

Emissions Control System Warranty

Zhejiang Zhongjian Technology Co., Ltd., CALIFORNIA AND FEDERAL EMISSION CONTROL WARRANTY STATEMENT YOUR WARRANTY RIGHTS AND OBLIGATIONS

The U.S. Environmental Protection Agency (EPA), the California Air Resources Board (CARB), and Zhejiang Zhongjian Technology Co., Ltd (hereinafter called Zhongjian), are pleased to explain the Emissions Control System Warranty on your new 2020/2021 small off-road engine. In California, new equipment that uses small off-road engines must be designed, built, and equipped to meet the state's stringent anti-smog standards. In other states, new small off-road engine must be designed, built and equipped at the time of sale to meet the U.S. EPA regulations for small off-road engines. The small off-road engine must be free from defects in materials and workmanship which cause it to fail to conform with U.S. EPA standards for the first two years of engine use from the date of sale to the ultimate purchaser. Zhongjian, must warrant the emission control system on your small off-road engine for the period of time listed above provided there has been no abuse, neglect, or improper maintenance of your small off-road engine.

Your emission control system may include parts such as the carburetor or fuel injection system, the ignition system, catalytic converters, fuel tanks, valves, filters, clamps, connectors, fuel lines, fuel caps, canisters, vapor hoses, and other associated components. Also included may be hoses, belts and connectors, and other emission-related assemblies.

MANUFACTURER'S WARRANTY COVERAGE

This 1995 and later small off-road emissions control system is warranted for two years. If any emission-related part on your engine is defective, the part will be repaired or replaced by Zhongjian.

OWNER'S WARRANTY RESPONSIBILITIES

(a) As the small off-road engine owner, you are responsible for the performance of the required maintenance listed in your operator's manual. Zhongjian, recommends that you retain all receipts covering maintenance on your small off-road engine, but Zhongjian, cannot deny warranty solely for the lack of receipts or for your failure to ensure the performance of all scheduled maintenance.

(b) As the small off-road engine owner, you should be aware, however, that Zhongjian, may deny you warranty coverage if small off-road engine or a part has failed due to abuse, neglect, improper maintenance, or unapproved modifications.

(c) You are responsible for presenting your small off-road engine to a service center as soon as a problem exists. The warranty repairs should be completed in a reasonable amount of time, not to exceed 30 days.

If you have any questions regarding your warranty rights and responsibilities, you should contact a Zhongjian, Customer Representative at [Phone Number] or [website determined by brand].

DEFECT WARRANTY COVERAGE REQUIREMENTS:

(a) The warranty period begins on the date the engine or equipment is delivered to an ultimate purchaser.

(b) General Emissions Warranty Coverage. Zhongjian, warrants to the ultimate purchaser and each subsequent purchaser that your small off-road engine is designed, built, and equipped at the time of sale to conform with all applicable regulations adopted by the California Air Resources Board or the United States Environmental Protection Agency; and that it is free from defects in materials and workmanship which cause the engine to fail to conform with applicable regulations for a period of two years from the date the small off-road engine is purchased by the initial purchaser. Any replacement part or service that is equivalent in performance and durability may be used in non-warranty maintenance or repairs, and shall not reduce the warranty obligations of Zhongjian.

(c) The warranty on emissions-related parts will be interpreted as follows: Any warranted part that is not scheduled for replacement as required in the Maintenance Schedule is warranted for two

years. If any such part (including any part that is scheduled only for regular inspection) fails during the period of warranty coverage, it will be repaired or replaced at any [BRAND] ® Authorized Service Center at no charge. Any such part repaired or replaced under warranty will be warranted for the remaining warranty period. A statement to the effect of “repair or replace as necessary” would not reduce the period of warranty coverage. Any warranted part that is scheduled for replacement as required maintenance in the Maintenance Schedule is warranted for the period of time prior to the first scheduled replacement point for that part. Any such part repaired or replaced under warranty is warranted for the remainder of the period prior to the first scheduled replacement point, and will be repaired or replaced at any [BRAND]® Authorized Service Center for no charge until that replacement point is reached.

Zhongjian shall remedy warranty defects at any authorized [BRAND] ® Authorized Service Center, including any distribution center that may be franchised to service the subject engines. Any diagnostic work done at a [BRAND] ® Authorized Service Center shall be free of charge to the owner if such work determines that a warranted part is defective. Any manufacturer-approved or equivalent replacement part may be used for any warranty maintenance or repairs on emission-related parts, and must be provided free of charge to the owner if the part is still under warranty. Zhongjian, is liable for damages to other engine components caused by the failure of a warranted part still under warranty.

Add-on or modified parts that are not exempted by the California Air Resource Board may not be used. The use of any non-exempted add-on or modified parts will be grounds for disallowing a warranty claim. Zhongjian, will not be liable to warrant failures of warranted parts caused by the use of a non-exempted add-on or modified part.

The Emission Parts List specifically defines the emission-related warranted parts. Zhongjian, will provide any documents that describe its warranty procedures or policies within five days upon request by the California Air Resources Board.

EMISSIONS PARTS LIST (IF EQUIPED)

Exhaust Emissions

Fuel Metering System	Carburetor and internal parts (and/or pressure regulator or fuel injection system)
	Air/fuel ratio feedback and control system
	Cold start enrichment system
Air Induction System	Controlled hot air intake system
	Intake manifold
	Air filter
Ignition System	Spark Plugs
	Magneto or electronic ignition system
	Spark advance/retard system
Exhaust Gas Recirculation (EGR) System	EGR valve body, and carburetor spacer if applicable
	EGR rate feedback and control system
Air injection System	Air pump or pulse valve
	Valves affecting distribution of flow
	Distribution manifold
Catalyst or Thermal Reactor System	Catalytic converter
	Thermal reactor
	Exhaust manifold
Particulate Controls	Traps, filters, precipitators, and any other device used to capture particulate emissions
Miscellaneous items Used in Above Systems	Vacuum, temperature, and time sensitive valves and sw itche
	Electronic controls
	Hoses, belts, connectors, and assemblies

Evaporative Emissions

- | | | | |
|-----|--------------------------|------|---------------------------------|
| (1) | Fuel Tank | (10) | Vacuum Control Diaphragms** |
| (2) | Fuel Cap | (11) | Control Cables** |
| (3) | Fuel Line | (12) | Control Linkages** |
| (4) | Fuel Line Fittings | (13) | Purge Valves |
| (5) | Clamps** | (14) | Vapor Hoses |
| (6) | Pressure Relief Valves** | (15) | Liquid/Vapor Separator |
| (7) | Control Valves** | (16) | Carbon Canister |
| (8) | Control Solenoids** | (17) | Canister Mounting Brackets |
| (9) | Electronic Controls** | (18) | Carburetor Purge Port Connector |

**Note: As they relate to the evaporative emission control system.

Zhongjian, will furnish with each new engine written instructions for its maintenance and use by the owner.

PRORUN regularly improves our products, and you may find slight differences between your machine and descriptions contained within this operator's manual. Modifications can be made to the machine without notice and without the obligation to update the manual, providing that the essential safety and functional characteristics remain unaltered. Contact PRORUN Customer Service with any questions and for current specifications.

PRORUN / TOPSUN USA
200 Overhill Drive, Suite A
Mooresville, NC 28117
www.proruntech.com

Zhejiang Zhongjian Technology Co., Ltd
Web: www.topsunpower.cc
E-mail: sales@topsunpower.cc
ADD: No.155 Mingyuan North AVE, Economic Development Zone,
Yongkang, Zhejiang, 321300, P.R. CHINA
Made in China

