

Sinber Kitchen Sink Introduction

HU3018S

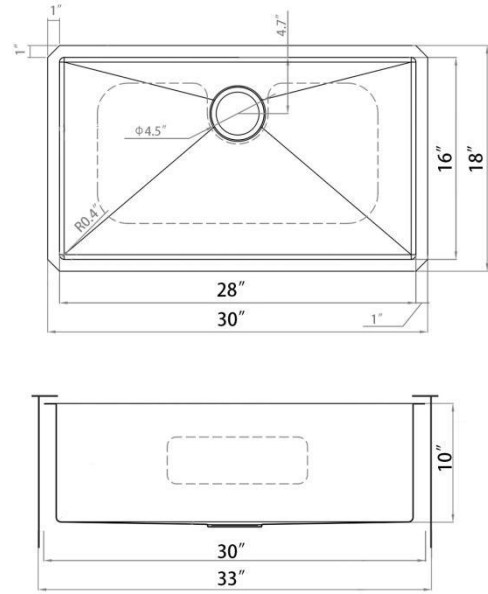

Minimum Base Cabinet: 33 inches
Sink Net Weight: 17.85 lbs

HU3018S 30" L x 18" W Undermount Kitchen Sink			
Installation Type	Undermount	Sink Shape	Rectangular
Primary Material	304 Stainless Steel	Stainless Steel Gauge	18
Resistance Type	Scratch; Stain; Rust; Heat; Fade	Sound Dampening	Yes
Finish	Silver	Craftsmanship Type	Handmade
Overall Product Weight	17.85 lb.	Overall Dimensions	33" L x 18" W x 10" H
Basin	18" W x 30" L x 10" D	Drain Placement	Center
Number of Faucet Holes	0	Supplier Intended and Approved Use	Residential Use; Non Residential Use
cUPC Certificates	Yes	Warranty	Lifetime Limited
Installation Required	Yes	Cut Out Template Included	Yes
Package Includes: Undermount sink, mounting hardware and cut-out template.			