



MODEL W1686 1HP OSCILLATING SPINDLE SANDER



OWNER'S MANUAL

(FOR MACHINES MANUFACTURED SINCE 11/10)

Phone: (360) 734-3482 • Online Technical Support: techsupport@woodstockint.com

COPYRIGHT © AUGUST, 2002 BY WOODSTOCK INTERNATIONAL, INC. REVISED JULY, 2018 (MN)

WARNING: NO PORTION OF THIS MANUAL MAY BE REPRODUCED IN ANY SHAPE OR FORM WITHOUT

THE WRITTEN APPROVAL OF WOODSTOCK INTERNATIONAL, INC.



WARNING!

This manual provides critical safety instructions on the proper setup, operation, maintenance, and service of this machine/tool. Save this document, refer to it often, and use it to instruct other operators.

Failure to read, understand and follow the instructions in this manual may result in fire or serious personal injury—including amputation, electrocution, or death.

The owner of this machine/tool is solely responsible for its safe use. This responsibility includes but is not limited to proper installation in a safe environment, personnel training and usage authorization, proper inspection and maintenance, manual availability and comprehension, application of safety devices, cutting/sanding/grinding tool integrity, and the usage of personal protective equipment.

The manufacturer will not be held liable for injury or property damage from negligence, improper training, machine modifications or misuse.



WARNING!

Some dust created by power sanding, sawing, grinding, drilling, and other construction activities contains chemicals known to the State of California to cause cancer, birth defects or other reproductive harm. Some examples of these chemicals are:

- Lead from lead-based paints.
- Crystalline silica from bricks, cement and other masonry products.
- Arsenic and chromium from chemically-treated lumber.

Your risk from these exposures varies, depending on how often you do this type of work. To reduce your exposure to these chemicals: Work in a well ventilated area, and work with approved safety equipment, such as those dust masks that are specially designed to filter out microscopic particles.

Contents

INTRODUCTION	2	ACCESSORIES	28
Woodstock Technical Support	2	Spindle Sander Accessories	28
Machine Specifications	3	MAINTENANCE	30
Identification	5	General	30
Controls & Components	6	Cleaning & Protecting	30
SAFETY	7	Changing Gearbox Oil	31
Standard Machinery Safety Instructions	7	Cleaning Sanding Sleeves	31
Additional Safety for Spindle Sanders	9	SERVICE	32
ELECTRICAL	10	Troubleshooting.....	32
Circuit Requirements	10	Electrical Safety Instructions.....	34
Grounding Requirements.....	11	Wiring Diagram	35
Extension Cords	11	PARTS	36
Converting Voltage to 240V	12	Main	36
SETUP	13	Spindle & Base.....	38
Unpacking	13	WARRANTY	41
Items Needed for Setup.....	13		
Hardware Recognition Chart	14		
Inventory	15		
Cleaning Machine.....	16		
Machine Placement	17		
Assembly.....	18		
Dust Collection	20		
Check Gearbox Oil	21		
Test Run.....	21		
OPERATIONS	22		
General	22		
Stock Inspection.....	23		
Sanding Tips.....	23		
Installing Sanding Spindles.....	24		
Replacing Sanding Sleeves	25		
Installing Table Inserts	26		
Contour Sanding	26		
Bevel Sanding	27		





INTRODUCTION

Woodstock Technical Support

This machine has been specially designed to provide many years of trouble-free service. Close attention to detail, ruggedly built parts and a rigid quality control program assure safe and reliable operation.

Woodstock International, Inc. is committed to customer satisfaction. Our intent with this manual is to include the basic information for safety, setup, operation, maintenance, and service of this product.

We stand behind our machines! In the event that questions arise about your machine, please contact Woodstock International Technical Support at (360) 734-3482 or send e-mail to: tech-support@shopfox.biz. Our knowledgeable staff will help you troubleshoot problems and process warranty claims.

If you need the latest edition of this manual, you can download it from <http://www.shopfox.biz>.

If you have comments about this manual, please contact us at:

Woodstock International, Inc.
Attn: Technical Documentation Manager
P.O. Box 2309
Bellingham, WA 98227
Email: manuals@woodstockint.com

MACHINE SPECIFICATIONS



© Woodstock International, Inc. • Phone: (800) 840-8420 • Web: www.shopfox.biz

MODEL W1686 1 HP OSCILLATING SPINDLE SANDER

Product Dimensions

Weight..... 287 lbs.
 Width (side-to-side) x Depth (front-to-back) x Height..... 25-1/4 x 28-3/4 x 44-1/2 in.
 Footprint (Length x Width)..... 16 x 16 in.

Shipping Dimensions

Type..... Wood Crate
 Content..... Machine
 Weight..... 381 lbs.
 Length x Width x Height..... 26 x 28 x 37 in.

Electrical

Power Requirement..... 120V or 240V, Single-Phase, 60 Hz
 Prewired Voltage..... 120V
 Full-Load Current Rating..... 12A at 120V, 6A at 240V
 Minimum Circuit Size..... 15A at 120V, 15A at 240V
 Connection Type..... Cord & Plug
 Power Cord Included..... Yes
 Power Cord Length..... 12 ft.
 Power Cord Gauge..... 16 AWG
 Plug Included..... Yes
 Included Plug Type..... 5-15 for 120V
 Recommended Plug Type..... 6-15 for 240V
 Switch Type..... Paddle Safety Switch w/Removable Key

Motors

Main

Horsepower..... 1 HP
 Phase..... Single-Phase
 Amps..... 12A/6A
 Speed..... 1720 RPM
 Type..... TEFC Capacitor-Start Induction
 Power Transfer Direct Drive
 Bearings..... Shielded & Permanently Lubricated
 Centrifugal Switch/Contacts Type..... External

Main Specifications



Spindle Sander Info

Sanding Drum Diameters.....	1/4, 3/8, 1/2, 5/8, 3/4, 1, 1-1/2, 2, 3, 4 in.
Sanding Drum Length.....	5, 6, 9 in.
Spindle Speed.....	1720 RPM
Spindle Oscillation.....	72 SPM
Stroke Length.....	1-1/2 in.
Table Length.....	25-1/4 in.
Table Width.....	25-1/4 in.
Table Thickness.....	1-1/8 in.
Table-to-Floor Height.....	35-1/2 in.
Number of Table Inserts.....	3
Included Sanding Sleeve Grit Size.....	100
Table Tilt.....	Front 45, Back 20 deg.

Construction Materials

Base.....	Formed Steel
Stand.....	Formed Steel
Table.....	Ground Cast Iron
Frame.....	Sheet Metal
Paint Type/Finish.....	Powder Coated

Other Related Info

Number of Dust Ports.....	1
Dust Port Size.....	4 in.
Compatible Mobile Base.....	D2260A

Other

Country of Origin	Taiwan
Warranty	2 Years
Approximate Assembly & Setup Time	45 Minutes
Serial Number Location	Machine ID Label
ISO 9001 Factory	No
Certified by a Nationally Recognized Testing Laboratory (NRTL)	Yes

Features

- Features Ground Steel Table Inserts
- Includes Formed and Welded Steel Stand
- 100-Grit Sleeve Included for Each Spindle
- Cast-Iron Table
- Table Tilts 45 deg.

Identification

Become familiar with the names and locations of the controls and features shown below to better understand the instructions in this manual.

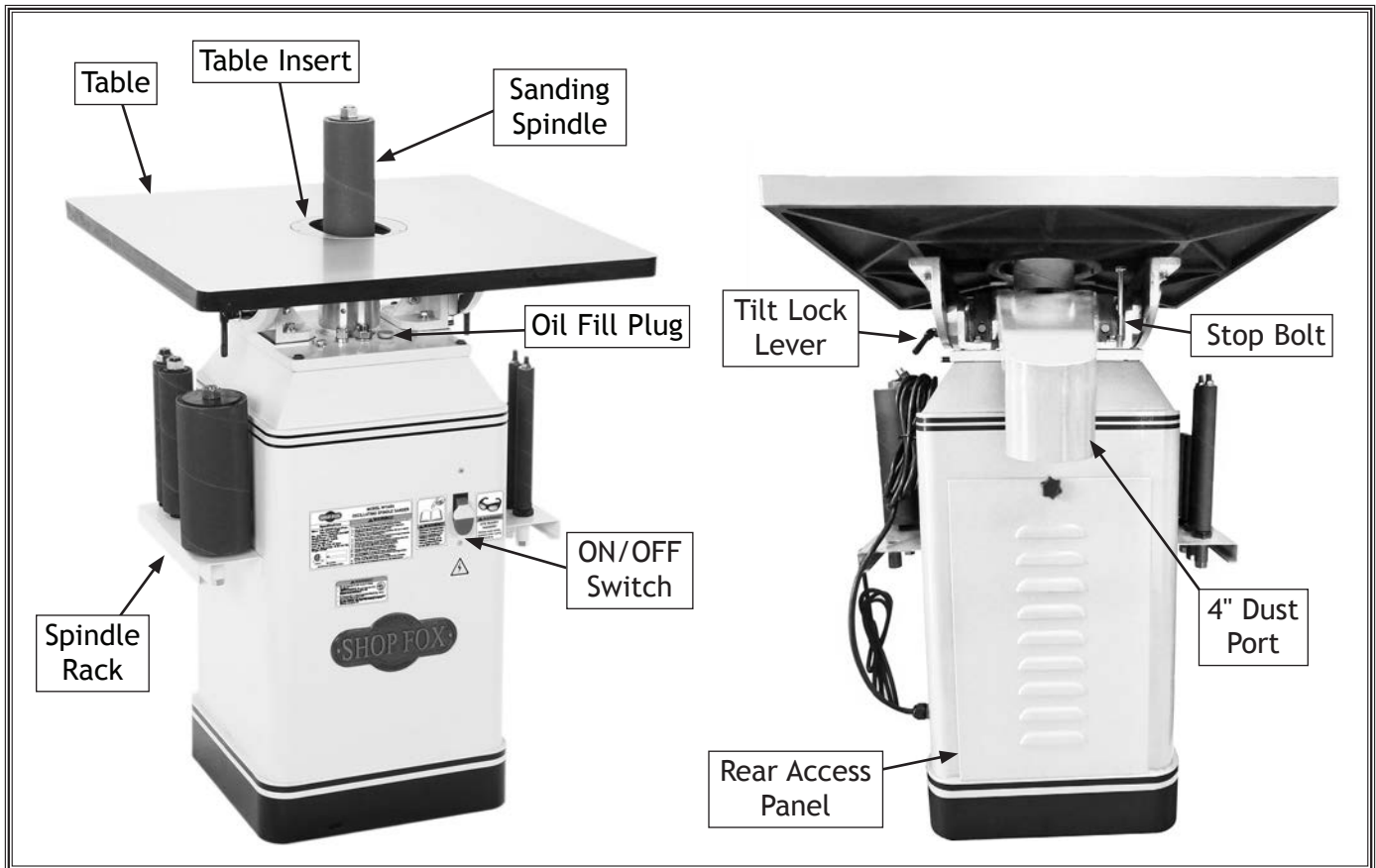

WARNING

For Your Own Safety Read This Manual Before Operating Spindle Sander

- a) Wear eye protection.
- b) Support workpiece on worktable.
- c) Minimize pinch hazards. Use the insert with the smallest possible opening with spindle assembly.
- d) Avoid kickback. Feed workpiece against rotation of drum.
- e) Avoid entanglement with spinning drum. Do not wear gloves, necktie, or loose clothing. Tie back long hair.

Controls & Components

Refer to Figures 1-4 and the following descriptions to become familiar with the basic controls and components of this machine. Understanding these items and how they work will help you understand the rest of the manual and stay safe when operating this machine.

⚠️ WARNING

To reduce your risk of serious injury or damage to the machine, read this entire manual **BEFORE** using machine.

- A. **Table:** Provides sanding platform with -20° to $+45^{\circ}$ tilt positioning.
- B. **Table Inserts:** Covers opening in table surrounding sanding spindle.
- C. **Sanding Spindle:** Shaft on which a sanding drum is mounted. Rotates and oscillates when motor is turned **ON**.
- D. **Table Tilt Lock Levers:** Tightens and loosens table tilt bracket to adjust tilt position.
- E. **Table Tilt Scale:** Indicates degree of table tilt.
- F. **ON/OFF Switch:** Turns spindle sander **ON** and **OFF**. Remove yellow key to disable switch.
- G. **Stop Bolt:** Stops table tilt position at 0°

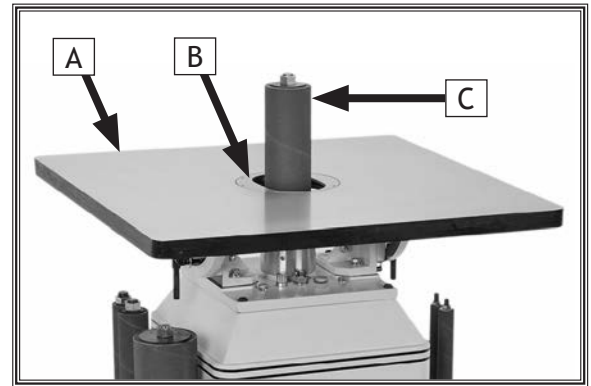

Figure 1. Upper table components.

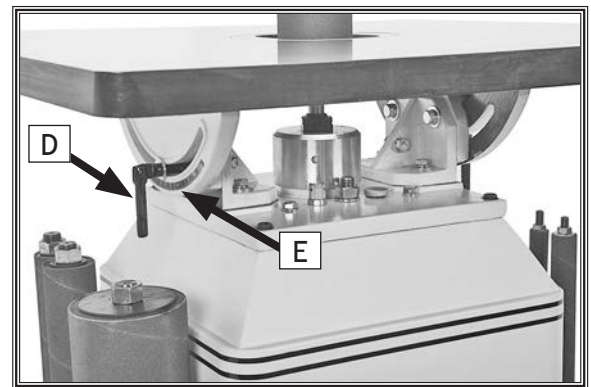

Figure 2. Lower table components.

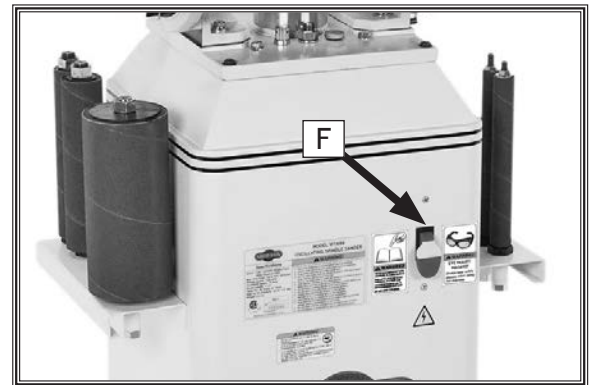

Figure 3. Body components.

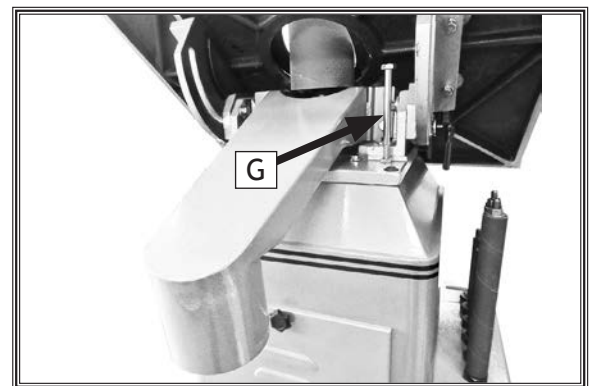

Figure 4. Rear components.

SAFETY

For Your Own Safety, Read Manual Before Operating Machine

The purpose of safety symbols is to attract your attention to possible hazardous conditions. This manual uses a series of symbols and signal words intended to convey the level of importance of the safety messages. The progression of symbols is described below. Remember that safety messages by themselves do not eliminate danger and are not a substitute for proper accident prevention measures—this responsibility is ultimately up to the operator!



Indicates an imminently hazardous situation which, if not avoided, **WILL** result in death or serious injury.



Indicates a potentially hazardous situation which, if not avoided, **COULD** result in death or serious injury.



Indicates a potentially hazardous situation which, if not avoided, **MAY** result in minor or moderate injury.

NOTICE

This symbol is used to alert the user to useful information about proper operation of the equipment or a situation that may cause damage to the machinery.

Standard Machinery Safety Instructions

OWNER'S MANUAL. Read and understand this owner's manual **BEFORE** using machine.

TRAINED OPERATORS ONLY. Untrained operators have a higher risk of being hurt or killed. Only allow trained/supervised people to use this machine. When machine is not being used, disconnect power, remove switch keys, or lock-out machine to prevent unauthorized use—especially around children. Make workshop kid proof!

DANGEROUS ENVIRONMENTS. Do not use machinery in areas that are wet, cluttered, or have poor lighting. Operating machinery in these areas greatly increases the risk of accidents and injury.

MENTAL ALERTNESS REQUIRED. Full mental alertness is required for safe operation of machinery. Never operate under the influence of drugs or alcohol, when tired, or when distracted.

ELECTRICAL EQUIPMENT INJURY RISKS. You can be shocked, burned, or killed by touching live electrical components or improperly grounded machinery. To reduce this risk, only allow an electrician or qualified service personnel to do electrical installation or repair work, and always disconnect power before accessing or exposing electrical equipment.

DISCONNECT POWER FIRST. Always disconnect machine from power supply **BEFORE** making adjustments, changing tooling, or servicing machine. This eliminates the risk of injury from unintended startup or contact with live electrical components.

EYE PROTECTION. Always wear ANSI-approved safety glasses or a face shield when operating or observing machinery to reduce the risk of eye injury or blindness from flying particles. Everyday eyeglasses are not approved safety glasses.

WEARING PROPER APPAREL. Do not wear clothing, apparel, or jewelry that can become entangled in moving parts. Always tie back or cover long hair. Wear non-slip footwear to avoid accidental slips, which could cause loss of workpiece control.

HAZARDOUS DUST. Dust created while using machinery may cause cancer, birth defects, or long-term respiratory damage. Be aware of dust hazards associated with each workpiece material, and always wear a NIOSH-approved respirator to reduce your risk.

HEARING PROTECTION. Always wear hearing protection when operating or observing loud machinery. Extended exposure to this noise without hearing protection can cause permanent hearing loss.

REMOVE ADJUSTING TOOLS. Tools left on machinery can become dangerous projectiles upon startup. Never leave chuck keys, wrenches, or any other tools on machine. Always verify removal before starting!

INTENDED USAGE. Only use machine for its intended purpose—never make modifications without prior approval from Woodstock International. Modifying machine or using it differently than intended will void the warranty and may result in malfunction or mechanical failure that leads to serious personal injury or death!

AWKWARD POSITIONS. Keep proper footing and balance at all times when operating machine. Do not overreach! Avoid awkward hand positions that make workpiece control difficult or increase the risk of accidental injury.

CHILDREN & BYSTANDERS. Keep children and bystanders at a safe distance from the work area. Stop using machine if they become a distraction.

GUARDS & COVERS. Guards and covers reduce accidental contact with moving parts or flying debris—make sure they are properly installed, undamaged, and working correctly.

FORCING MACHINERY. Do not force machine. It will do the job safer and better at the rate for which it was designed.

NEVER STAND ON MACHINE. Serious injury may occur if machine is tipped or if the cutting tool is unintentionally contacted.

STABLE MACHINE. Unexpected movement during operation greatly increases risk of injury or loss of control. Before starting, verify machine is stable and mobile base (if used) is locked.

USE RECOMMENDED ACCESSORIES. Consult this owner's manual or the manufacturer for recommended accessories. Using improper accessories will increase risk of serious injury.

UNATTENDED OPERATION. To reduce the risk of accidental injury, turn machine **OFF** and ensure all moving parts completely stop before walking away. Never leave machine running while unattended.

MAINTAIN WITH CARE. Follow all maintenance instructions and lubrication schedules to keep machine in good working condition. A machine that is improperly maintained could malfunction, leading to serious personal injury or death.

CHECK DAMAGED PARTS. Regularly inspect machine for any condition that may affect safe operation. Immediately repair or replace damaged or mis-adjusted parts before operating machine.

MAINTAIN POWER CORDS. When disconnecting cord-connected machines from power, grab and pull the plug—NOT the cord. Pulling the cord may damage the wires inside, resulting in a short. Do not handle cord/plug with wet hands. Avoid cord damage by keeping it away from heated surfaces, high traffic areas, harsh chemicals, and wet/damp locations.

EXPERIENCING DIFFICULTIES. If at any time you experience difficulties performing the intended operation, stop using the machine! Contact Technical Support at (360) 734-3482.

Additional Safety for Spindle Sanders

WARNING

Serious injury or death can occur from fingers, clothing, jewelry or hair getting entangled in rotating spindle or other moving components. Abrasion injuries can occur from touching rotating sanding drum with bare skin. Workpieces thrown by drum can strike operator or bystanders with moderate force, causing impact injuries. Long-term respiratory damage can occur from using sander without proper use of a respirator. To reduce the risk of these hazards, operator and bystanders **MUST** completely heed the hazards and warnings below.

HAND PLACEMENT. Rotating sanding drums can remove a large amount of flesh in a few seconds. Always keep hands away from drum during operation. Never touch moving drum on purpose. Use a brush to clean table of sawdust and chips.

FEEDING WORKPIECE. Forcefully jamming workpiece into sanding surface could cause workpiece to eject back at operator or damage machine. Always allow spindle to reach full speed. Firmly hold workpiece with both hands and ease it against spindle using light pressure.

DRUM DIRECTION. Feeding workpiece incorrectly can cause it to be thrown from machine, allowing your hands to slip into the rotating drum or striking yourself or bystanders. To reduce these risks, feed workpiece against direction of rotation, and never sand tapered or pointed stock with point facing feed direction.

SANDING DUST. Sanding creates large amounts of dust and flying chips that can lead to eye injury or serious respiratory illness. Reduce your risk by always wearing approved eye and respiratory protection when using sander. Never operate without adequate dust collection system in place and running. However, dust collection is not a substitute for using a respirator.

AVOIDING ENTANGLEMENT. DO NOT wear loose clothing, gloves, or jewelry, and tie back long hair. Keep all guards in place and secure.

WORKPIECE INSPECTION. Nails, staples, knots, or other imperfections in workpiece can be dislodged and thrown from sander at high rate of speed into operator or bystanders, or cause damage to sanding sleeves or drum. Never sand stock that has embedded foreign objects or questionable imperfections.

TABLE INSERTS. A pinch point for fingers and workpieces exists in the gap between table and oscillating drum. Always use table insert that fits closest to diameter of installed drum to keep this gap as small as possible and reduce risk of injury.

POWER DISCONNECT. An accidental startup while changing sleeves can result in entanglement or abrasion injuries. Always disconnect machine from power source before changing sanding sleeve to avoid this risk.

WORKPIECE INTEGRITY. Sanding fragile workpieces can result in loss of control, resulting in entanglement, impact injuries, or damage to the sanding sleeve or drum. Only sand solid workpieces that can withstand power sanding forces. Make sure shape of workpiece is properly supported; avoid sanding workpieces without flat bottom surfaces unless some type of jig is used to maintain support and control when sanding force is applied.

SANDING SLEEVE CONDITION. Worn or damaged sanding sleeves can tear apart and become entangled in spindle, resulting in subsequent injuries from operator loss of workpiece control. Replace worn or damaged sanding sleeves promptly.

ELECTRICAL

Circuit Requirements

This machine must be connected to the correct size and type of power supply circuit, or fire or electrical damage may occur. Read through this section to determine if an adequate power supply circuit is available. If a correct circuit is not available, a qualified electrician **MUST** install one before you can connect the machine to power.

A power supply circuit includes all electrical equipment between the breaker box or fuse panel in the building and the machine. The power supply circuit used for this machine must be sized to safely handle the full-load current drawn from the machine for an extended period of time. (If this machine is connected to a circuit protected by fuses, use a time delay fuse marked D.)

Full-Load Current Rating

The full-load current rating is the amperage a machine draws at 100% of the rated output power. On machines with multiple motors, this is the amperage drawn by the largest motor or sum of all motors and electrical devices that might operate at one time during normal operations.

Full-Load Current Rating at 120V 12 Amps
 Full-Load Current Rating at 240V 6 Amps

Circuit Requirements for 120V (Prewired)

This machine is prewired to operate on a power supply circuit that has a verified ground and meets the following requirements:

Circuit Type 110V/120V, 60 Hz, Single-Phase
 Circuit Size 15 Amps
 Plug/Receptacle NEMA 5-15

Circuit Requirements for 240V

This machine can be converted to operate on a power supply circuit that has a verified ground and meets the requirements listed below. (Refer to **Voltage Conversion** instructions for details.)

Circuit Type 220V/240V, 60 Hz, Single-Phase
 Circuit Size 15 Amps
 Plug/Receptacle NEMA 6-15

⚠ WARNING
 The machine must be properly set up before it is safe to operate. **DO NOT** connect this machine to the power source until instructed to do so later in this manual.

⚠ WARNING

Incorrectly wiring or grounding this machine can cause electrocution, fire, or machine damage. To reduce this risk, only an electrician or qualified service personnel should do any required electrical work on this machine.

NOTICE
 The circuit requirements listed in this manual apply to a dedicated circuit—where only one machine will be running at a time. If this machine will be connected to a shared circuit where multiple machines will be running at the same time, consult with an electrician to ensure that the circuit is properly sized for safe operation.

ELECTRICAL

Grounding Requirements

This machine **MUST** be grounded. In the event of certain types of malfunctions or breakdowns, grounding provides a path of least resistance for electric current to travel—in order to reduce the risk of electric shock.

Improper connection of the equipment-grounding wire will increase the risk of electric shock. The wire with green insulation (with/without yellow stripes) is the equipment-grounding wire. If repair or replacement of the power cord or plug is necessary, do not connect the equipment-grounding wire to a live (current carrying) terminal.

Check with a qualified electrician or service personnel if you do not understand these grounding requirements, or if you are in doubt about whether the tool is properly grounded. If you ever notice that a cord or plug is damaged or worn, disconnect it from power, and immediately replace it with a new one.

For 120V Connection (Prewired)

This machine is equipped with a power cord with an equipment-grounding wire and NEMA 5-15 grounding plug (see figure). The plug must only be inserted into a matching receptacle that is properly installed and grounded in accordance with local codes and ordinances.

For 240V Connection

A NEMA 6-15 plug (see figure) has a grounding prong that must be attached to the equipment-grounding wire inside the included power cord. The plug must only be inserted into a matching receptacle that is properly installed and grounded in accordance with all local codes and ordinances.

Extension Cords

We do not recommend using an extension cord with this machine. Extension cords cause voltage drop, which may damage electrical components and shorten motor life. Voltage drop increases with longer extension cords and smaller gauge sizes (higher gauge numbers indicate smaller sizes).

Any extension cord used with this machine must contain a ground wire, match the required plug and receptacle, and meet the following requirements:

- Minimum Gauge Size 14 AWG
- Maximum Length (Shorter is Better) 50 ft.

⚠ WARNING

The machine must be properly set up before it is safe to operate. **DO NOT** connect this machine to the power source until instructed to do so later in this manual.

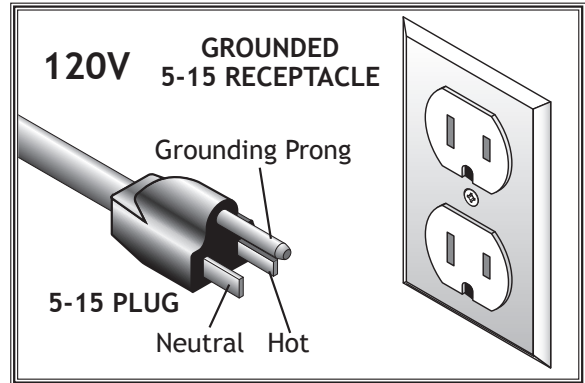

Figure 5. NEMA 5-15 plug & receptacle.

⚠ CAUTION

DO NOT modify the provided plug or use an adapter if the plug will not fit the receptacle. Instead, have an electrician install the proper receptacle on a power supply circuit that meets the requirements for this machine.

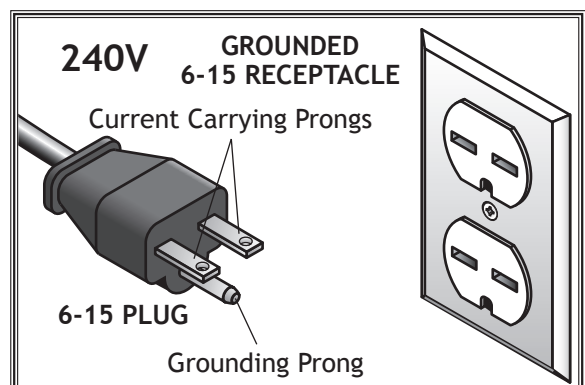

Figure 6. NEMA 6-15 plug & receptacle.

ELECTRICAL

Converting Voltage to 240V

The voltage conversion MUST be performed by an electrician or qualified service personnel.

The voltage conversion procedure consists of rewiring the motor and installing the correct plug. A wiring diagram is provided on **Page 35** for your reference.

IMPORTANT: *If the diagram included on the motor conflicts with the one on **Page 35**, the motor may have changed since the manual was printed. Use the diagram included on the motor instead.*

ELECTRICAL

Items Needed	Qty
• Phillips Head Screwdriver #2	1
• Electrical Tape	As Needed
• Wire Cutters/Stripper.....	1
• NEMA 6-15 Plug	1

To convert Model W1686 to 240V, do these steps:

1. DISCONNECT MACHINE FROM POWER!
2. Cut off existing 5-15 plug.
3. Open motor junction box and loosen two wire nuts.
4. Use wire nuts to connect wires as indicated in **Figure 7**. Twist wire nuts onto their respective wires and wrap them with electrical tape so they will not come loose.
5. Close and secure motor junction box.
6. Install a 6-15 plug on power cord, according to plug manufacturer's instructions.
 - If plug manufacturer's instructions are not available, NEMA standard 6-15 plug wiring is provided on **Page 35**.

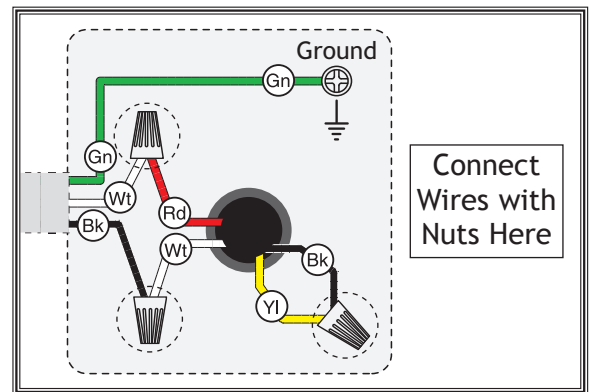

Figure 7. Motor rewired to 240V.

SETUP

Unpacking

This machine has been carefully packaged for safe transportation. If you notice the machine has been damaged during shipping, please contact your authorized Shop Fox dealer immediately.

Items Needed for Setup

The following items are needed, but not included, to set up your machine.

Description	Qty
• Additional Person.....	1
• Safety Glasses for Each Person.....	1
• Cleaner/Degreaser	As Needed
• Disposable Shop Rags	As Needed
• Machinist's Square	1
• Dust Collection System	1
• Dust Hose 4"	1
• Hose Clamps 4"	2



⚠ WARNING

This machine presents serious injury hazards to untrained users. Read through this entire manual to become familiar with the controls and operations before starting the machine!



⚠ WARNING

Wear safety glasses during entire setup process!



⚠ WARNING

SUFFOCATION HAZARD!

Immediately discard all plastic bags and packing materials to eliminate choking/suffocation hazards for children and animals.

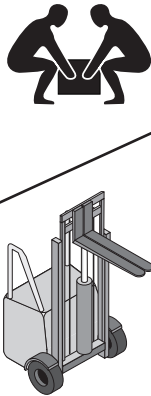

⚠ WARNING

HEAVY LIFT!

Straining or crushing injury may occur from improperly lifting the machine or some of its parts. To reduce this risk, get help from other people and use a forklift (or other lifting equipment) rated for weight of machine.

SETUP

Hardware Recognition Chart

USE THIS CHART TO IDENTIFY HARDWARE DURING THE INVENTORY/ASSEMBLY PROCESS.

SETUP

MEASURE BOLT DIAMETER BY PLACING INSIDE CIRCLE
LINES ARE 1MM APART

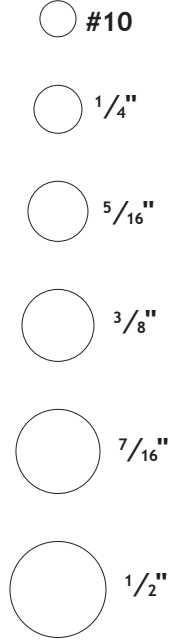
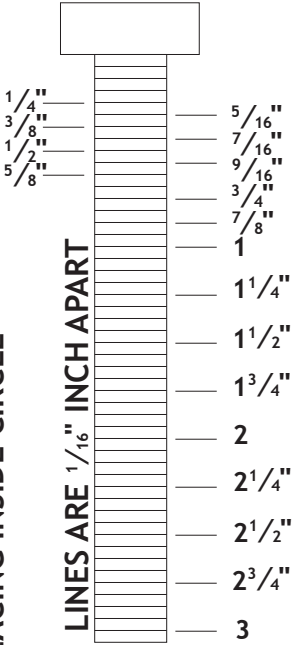

WASHERS ARE MEASURED BY THE INSIDE DIAMETER

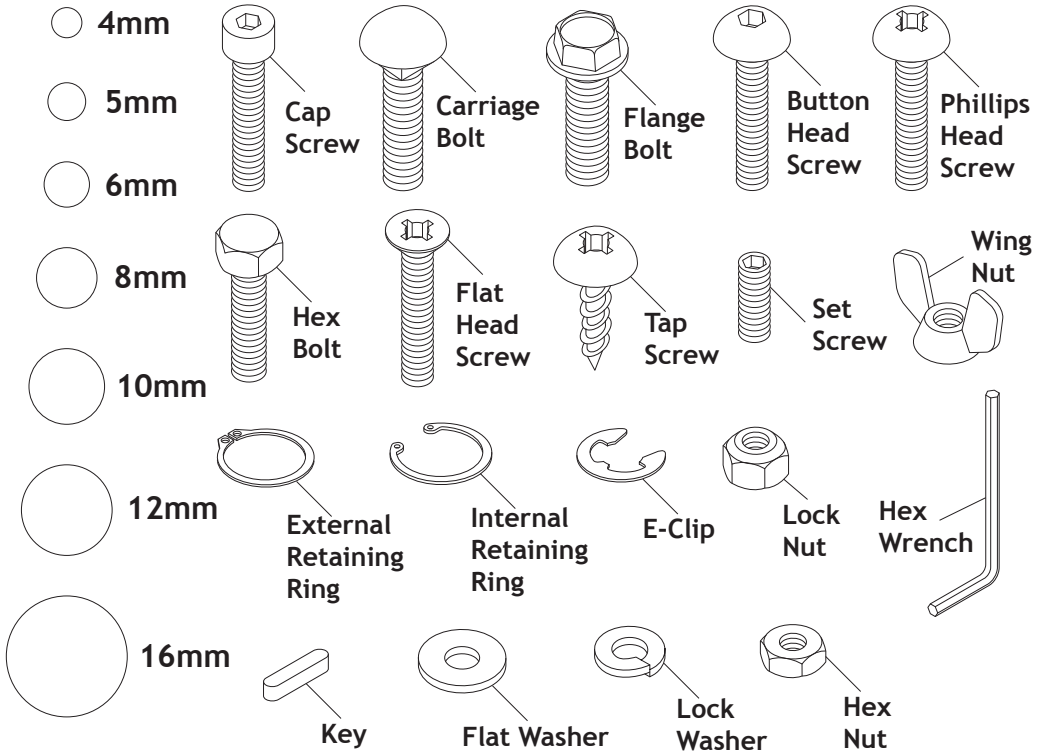
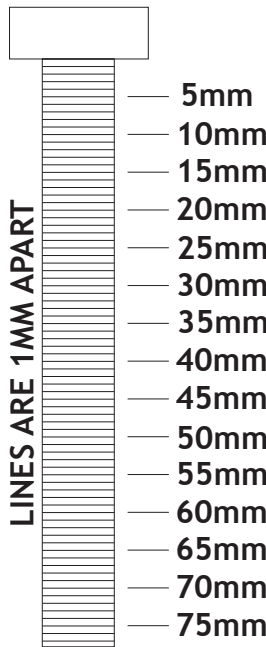
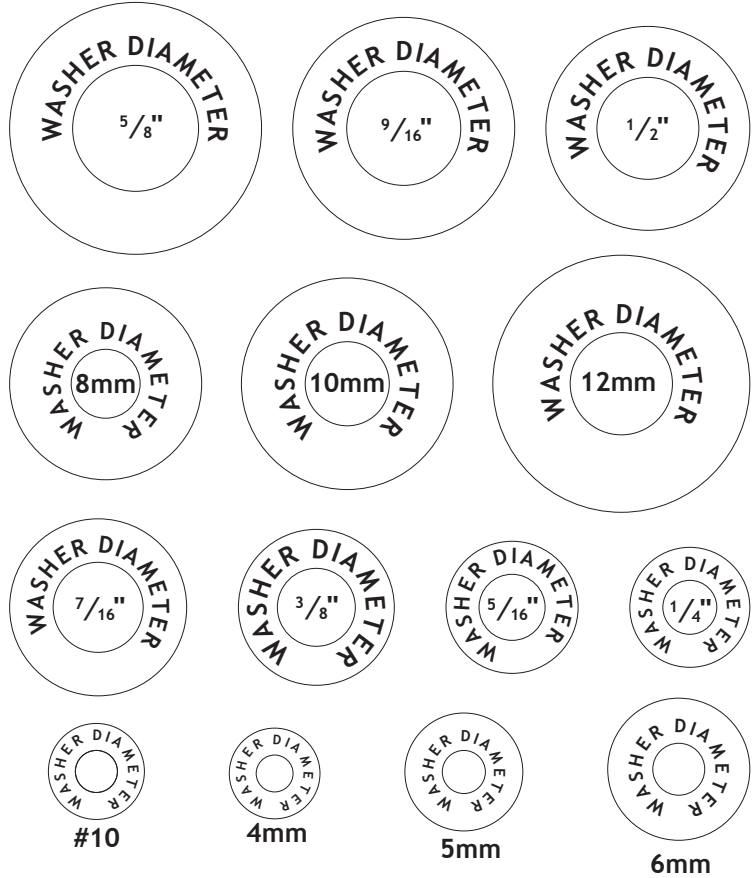

Inventory

The following is a list of items shipped with your machine. Before beginning setup, lay these items out and inventory them.

Note: If you cannot find an item on this list, carefully check around/inside the machine and packaging materials. Often, these items get lost in packaging materials while unpacking or they are pre-installed at the factory.

Box Contents (Figures 8-10)	Qty
A. Spindle Sander Unit (Not Shown)	1
B. Sanding Spindles	
1/4" x 5"	1
3/8" x 6"	1
1/2" x 6"	1
5/8" x 6"	1
3/4" x 9"	1
1" x 9"	1
1 1/2" x 9"	1
2" x 9"	1
3" x 9"	1
4" x 9"	1
C. Table Insert 1 3/4" x 2 3/16"	1
D. Table Insert 2 3/16" x 3 1/2"	1
E. Table Insert 4 1/4" x 6"	1
F. 4" Dust Chute.....	1
G. Combo Flat Wrench 7/8" x 1 1/4"	1
H. Spindle Wrench 1" x 3/4"	1
I. Flat Wrench 1 1/8"	1
J. Hex Wrench 2mm.....	1
K. Set Screws 1/4"-20 x 5/8".....	12
L. Roll Pins 5 x 28.....	3
M. Table Stop Bolt 3/8"-16 x 6 1/2" w/Hex Nut 3/8"-16	1

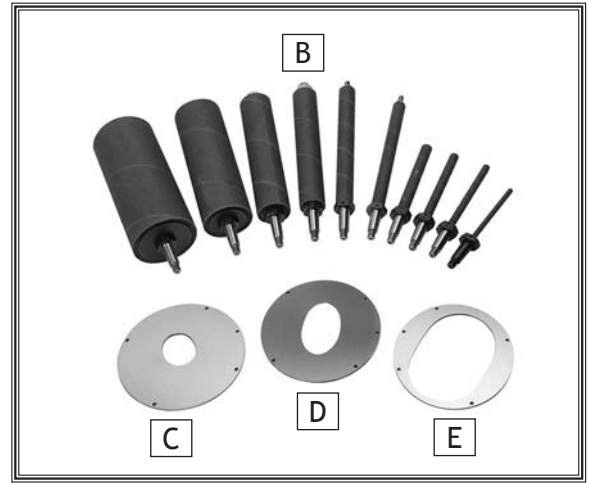

Figure 8. Sanding spindles and table inserts.



Figure 9. 4" Dust chute.

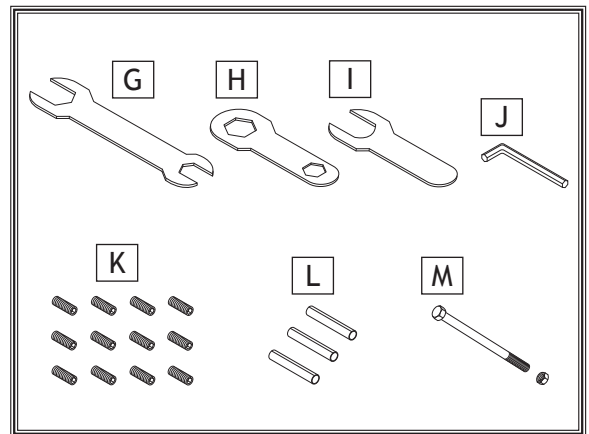

Figure 10. Tools and hardware.

SETUP

Cleaning Machine

To prevent corrosion during shipment and storage of your machine, the factory has coated the bare metal surfaces of your machine with a heavy-duty rust prevention compound.

If you are unprepared or impatient, this compound can be difficult to remove. To ensure that the removal of this coating is as easy as possible, please gather the correct cleaner, lubricant, and tools listed below:

- Cleaner/degreaser designed to remove storage wax and grease
- Safety glasses & disposable gloves
- Solvent brush or paint brush
- Disposable Rags

To remove rust preventative coating, do these steps:

1. DISCONNECT MACHINE FROM POWER!
2. Put on safety glasses and disposable gloves.
3. Coat the rust preventative with a liberal amount of cleaner/degreaser, then let it soak for 5-10 minutes.
4. Wipe off surfaces. If your cleaner/degreaser is effective, the coating will wipe off easily.

Tip: An easier way to clean off thick coats of rust preventative from flat surfaces is to use a PLASTIC paint scraper to scrape off the majority of the coating before wiping it off with your rag. (Do not use a metal scraper or you may scratch your machine.)

5. Repeat cleaning steps as necessary until all of the compound is removed.
6. To prevent rust on freshly cleaned surfaces, immediately coat with a quality metal protectant.

⚠ WARNING

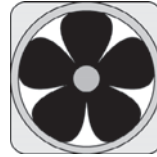

Gasoline and petroleum products have low flash points and can explode or cause fire if used to clean machinery. Avoid using these products to clean machinery. Many cleaning solvents are toxic if inhaled. Minimize your risk by only using these products in a well ventilated area.

NOTICE

In a pinch, automotive degreasers, mineral spirits or WD•40 can be used to remove rust preventative coating. Before using these products, though, test them on an inconspicuous area of your paint to make sure they will not damage it.

Machine Placement

Weight Load

Refer to the **Machine Specifications** for the weight of your machine. Make sure that the surface upon which the machine is placed will bear the weight of the machine, additional equipment that may be installed on the machine, and the heaviest workpiece that will be used. Additionally, consider the weight of the operator and any dynamic loading that may occur when operating the machine.

Space Allocation

Consider the largest size of workpiece that will be processed through this machine and provide enough space around the machine for adequate operator material handling or the installation of auxiliary equipment. With permanent installations, leave enough space around the machine to open or remove doors/covers as required by the maintenance and service described in this manual. **See below for required space allocation.**

Physical Environment

The physical environment where your machine is operated is important for safe operation and the longevity of its components. For best results, operate this machine in a dry environment that is free from excessive moisture, hazardous chemicals, airborne abrasives, or extreme conditions. Extreme conditions for this type of machinery are generally those where the ambient temperature range exceeds 41°-104°F; the relative humidity range exceeds 20-95% (non-condensing); or the environment is subject to vibration, shocks, or bumps.

Electrical Installation

Place this machine near an existing power source. Make sure all power cords are protected from traffic, material handling, moisture, chemicals, or other hazards. Make sure to leave access to a means of disconnecting the power source or engaging a lockout/tagout device.

Lighting

Lighting around the machine must be adequate enough that operations can be performed safely. Shadows, glare, or strobe effects that may distract or impede the operator must be eliminated.

	<p>⚠ CAUTION</p> <p>Children or untrained people may be seriously injured by this machine. Only install in an access restricted location.</p>
-------------------------------------------------------------------------------------	------------------------------------------------------------------------------------------------------------------------------------------------------

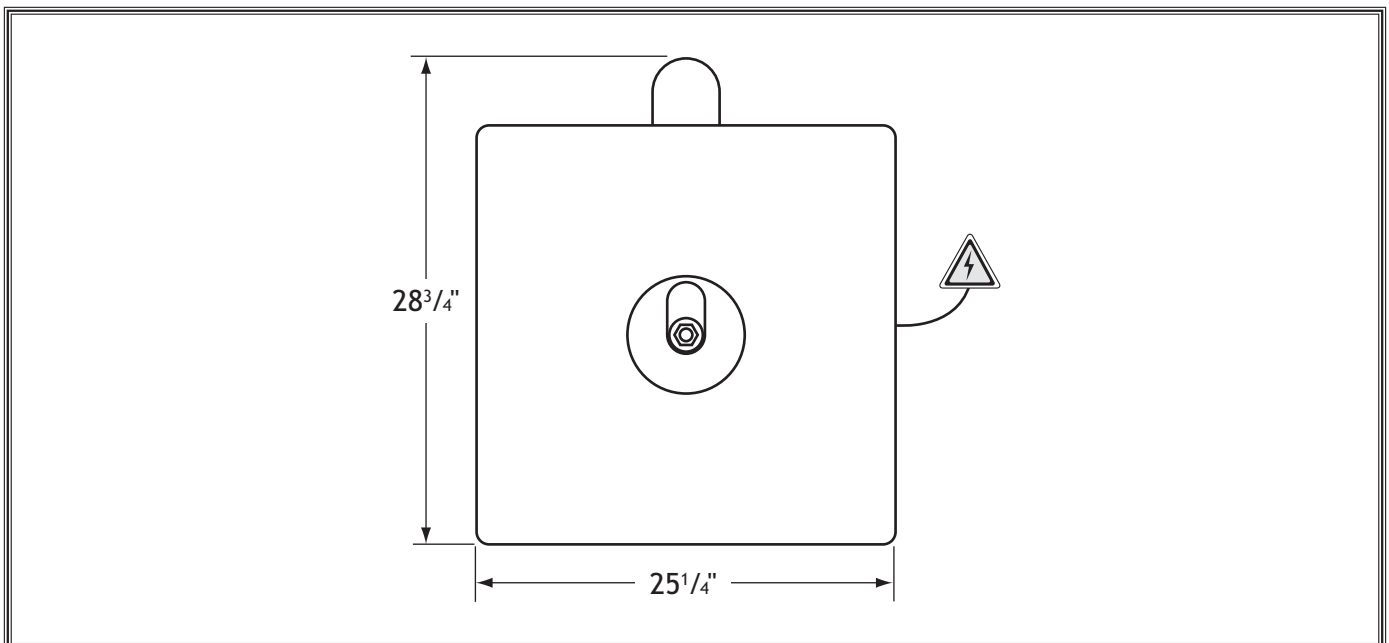

Figure 11. Working clearances.

Assembly

Before beginning the assembly process, refer to **Items Needed for Setup** and gather everything you need. Ensure all parts have been properly cleaned of any heavy-duty rust-preventative applied at the factory (if applicable). Be sure to complete all steps in the assembly procedure prior to performing the **Test Run**.

To assemble machine, do these steps:

1. Secure dust chute to trunnion assembly with pre-installed (2) $\frac{3}{8}$ "-16 x $1\frac{1}{2}$ " hex bolts, $\frac{3}{8}$ " lock washers, and $\frac{3}{8}$ "-16 hex nuts (see **Figure 12**).
2. Thread $\frac{3}{8}$ "-16 x $6\frac{1}{2}$ " stop bolt and jam nut into sander base, as shown in **Figure 13**.

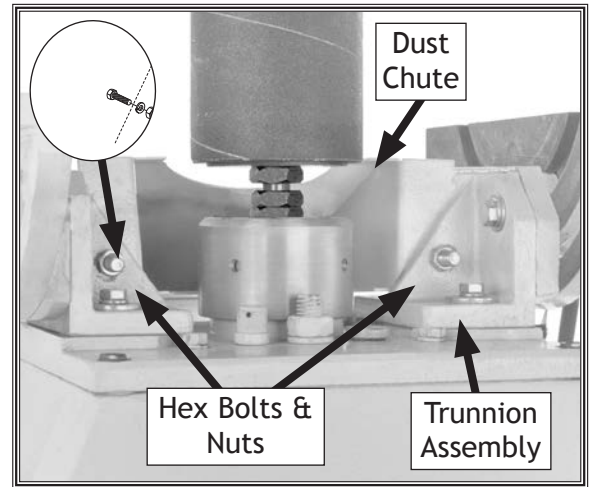

Figure 12. Trunnion assembly components.

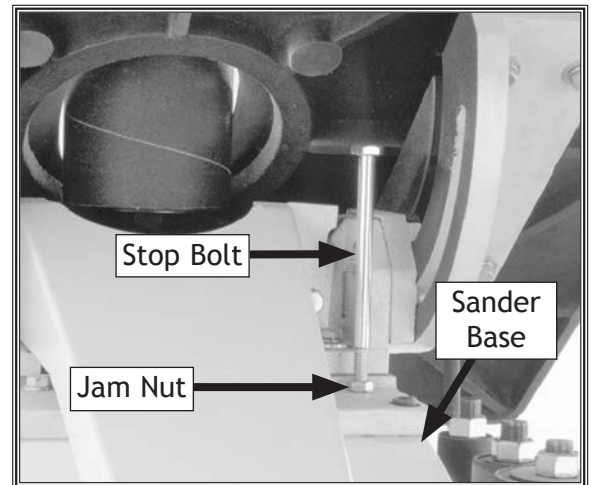

Figure 13. Location of table stop bolt.

3. Loosen table tilt lock levers located on each side of table trunnion assembly (see **Figure 14**).

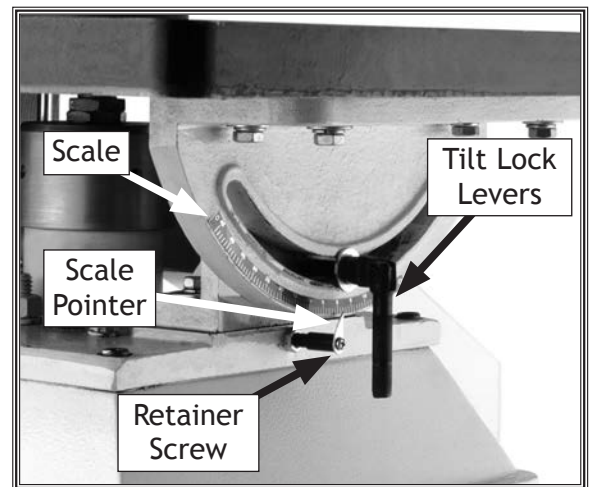

Figure 14. Pointer adjustment.

- Insert one 3 x 20mm roll pin into non-threaded hole in each of three table inserts, as shown in **Figure 15**. Make sure it does not extend through surface of table insert.

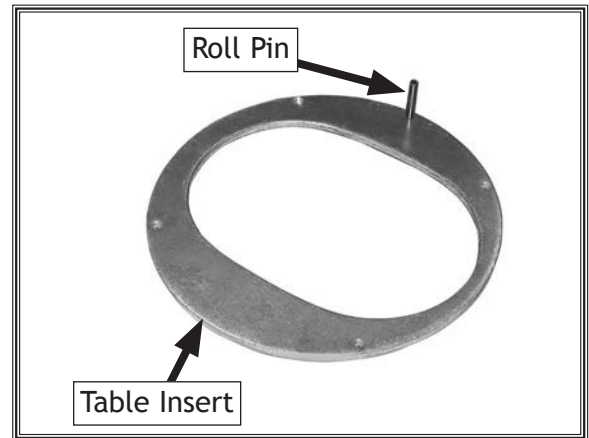

Figure 15. Inserting roll pins (bottom view).

- Thread four 1/4"-20 x 5/8" set screws into threaded holes in each table insert, as shown in **Figure 16**.

Note: The roll pins and set screws must not protrude above the top surface of the table insert or they will interfere with sanding operations.

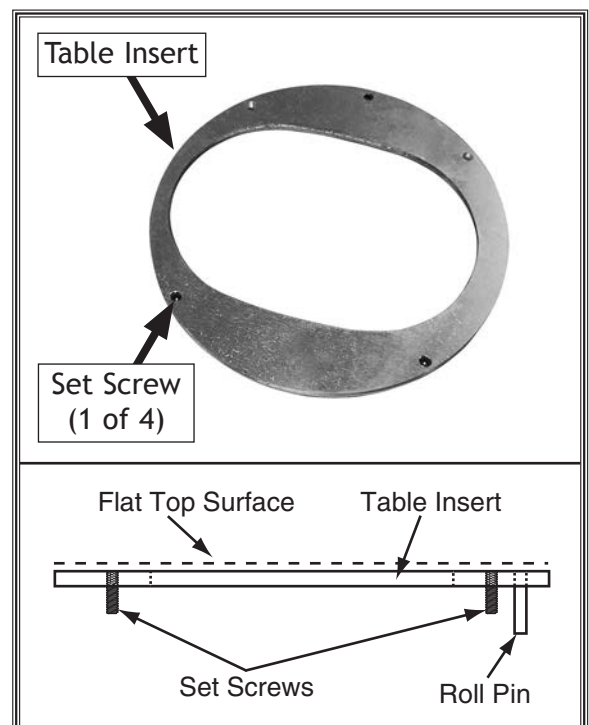

Figure 16. Inserting set screws.

- Using a machinist's square, bring table surface square to spindle surface, as shown in **Figure 17**.

Note: It may be necessary to thread the table stop bolt further into the base in order to make the table square to the spindle.

- Move square to various points around table to ensure table and spindle are square on all sides. Adjust stop bolt as necessary until table rests on stop bolt and is square with spindle.
- Re-tighten jam nut to secure table stop bolt.
- Tighten both tilt lock levers when you are satisfied with position of table.
- Loosen retainer screw (see **Figure 14**) that secures scale pointer and adjust pointer to read 0°. Re-tighten retainer screw.

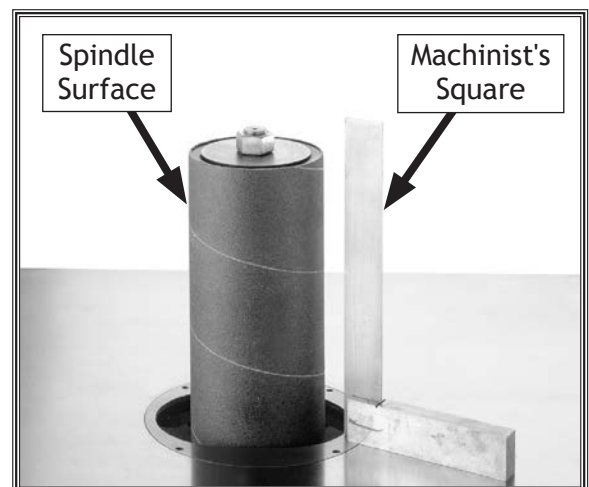

Figure 17. Checking table for square.

SETUP

Dust Collection

Recommended CFM at Dust Port: 400 CFM

Do not confuse this CFM recommendation with the rating of the dust collector. To determine the CFM at the dust port, you must consider these variables: (1) CFM rating of the dust collector, (2) hose type and length between the dust collector and the machine, (3) number of branches or wyes, and (4) amount of other open lines throughout the system. Explaining how to calculate these variables is beyond the scope of this manual. Consult an expert or purchase a good dust collection “how-to” book.



Figure 18. Dust port connected to dust collection system.

CAUTION

This machine creates substantial amounts of dust during operation. Breathing airborne dust on a regular basis can result in permanent respiratory illness. Reduce your risk by wearing a respirator and capturing the dust with a dust collection system.

SETUP

Tools Needed	Qty
Dust Collection System	1
Dust Hose 4"	1
Hose Clamps 4"	2

To connect machine to dust collection system, do these steps:

1. Fit a 4" dust hose over dust chute, as shown in **Figure 18**, and secure in place with hose clamp.
2. Tug hose to make sure it does not come off.

Note: A tight fit is necessary for proper performance.

Check Gearbox Oil



It is critical that you make sure there is oil in the gearbox before proceeding with the test run. Remove the spindle gearbox oil fill cap and use the dipstick to make sure the oil level is full. When full, the oil will read on the knurled portion of the dipstick.

Refer to **Changing Gearbox Oil** on **Page 31** for more information on gearbox lubrication, which type of oil to use, how much to use, and where to put it.

Test Run

Once the assembly is complete and you have verified that there is oil in the machine, test run the sander to make sure it runs properly and is ready for regular operation.

The test run consists of verifying the following:

- 1) The motor powers up and runs correctly, and
- 2) the safety disabling mechanism on the switch works correctly.

If you find an unusual problem during the test run, immediately stop the machine, disconnect it from power, and fix the problem **BEFORE** operating the machine again. The Troubleshooting table in the **SERVICE** section of this manual can help.

To test run the machine, do these steps:

1. Make sure you have read the safety instructions at the beginning of the manual and that the machine is set up properly.

2. Make sure all tools used during setup are cleared away from the machine.
3. Connect the machine to the power source.
4. Verify that the machine is operating correctly by turning it **ON**.
 - When operating correctly, the machine runs smoothly with little or no vibration or rubbing noises.
 - Investigate and correct strange or unusual noises or vibrations before operating the machine further. Always disconnect the machine from power when investigating or correcting potential problems.
5. Turn the machine **OFF**.
6. Remove switch disabling key, as shown below.

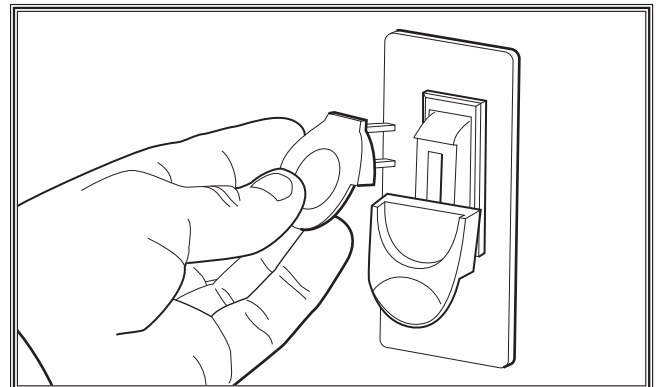

Figure 19. Removing key from paddle switch.

7. Try to start the machine with the paddle switch.
 - If the machine does not start, the switch disabling feature is working as designed.
 - If the machine starts, immediately stop it. The switch disabling feature is not working correctly. This safety feature must work properly before proceeding with regular operations. Call Tech Support for help.

SETUP

OPERATIONS

General

This machine will perform many types of operations that are beyond the scope of this manual. Many of these operations can be dangerous or deadly if performed incorrectly.

The instructions in this section are written with the understanding that the operator has the necessary knowledge and skills to operate this machine. If at any time you are experiencing difficulties performing any operation, stop using the machine!

The overview below provides the novice machine operator with a basic understanding of how the machine is used during operation, so the machine controls/components discussed later in this manual are easier to understand. Due to its generic nature, this overview is **NOT** intended to be an instructional guide.

To complete a typical operation, the operator does the following:

1. Examines workpiece to make sure it is suitable for sanding.
2. If necessary, tilts table to correct angle and tightens it in place.
3. Selects and installs sanding spindle with sanding sleeve. (Refer to **Installing Sanding Spindles on Page 24** and **Replacing Sanding Sleeves on Page 25.**)
4. Selects table insert best suited to accommodate size of sanding drum and tilt of table, while minimizing gap between table and drum.
5. Puts on safety glasses and respirator.
6. Starts spindle sander.
7. Feeds workpiece **AGAINST** direction of spindle rotation, maintaining a safe working distance between hands and sanding drum.
8. Turns machine **OFF**.

WARNING



To reduce your risk of serious injury or damage to the machine, read this entire manual **BEFORE** using machine.

WARNING

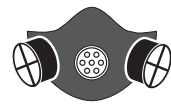

To reduce the risk of eye injury and long-term respiratory damage, always wear safety glasses and a respirator while operating this machine.

NOTICE

If you are an inexperienced operator, we strongly recommend that you read books or trade articles, or seek training from an experienced operator of this type of machinery before performing unfamiliar operations. Above all, safety must come first!

Stock Inspection

- **DO NOT** sand stock that contains large or loose knots. Injury to the operator or damage to the workpiece can occur if a knot becomes dislodged during the sanding operation.
- **Remove foreign objects from the workpiece.** Make sure that any stock you process with the sander is clean and free of dirt, nails, staples, tiny rocks or any other foreign objects that could damage the sanding belt or eject from the workpiece during sanding.
- **Scrape all glue off the workpiece before sanding.** Glue deposits on the workpiece, hard or soft, can gum up the sanding belt and produce poor results.
- **Only sand the proper material type:** This machine is only intended for sanding workpieces of natural wood fiber. Attempting to sand workpieces of any other material could lead to personal injury and property damage.



!WARNING
READ and understand this entire manual before using this machine. Serious personal injury may occur if safety and operational information is not understood and followed. **DO NOT** risk your safety by not reading!

Sanding Tips

- Replace the sanding sleeve with a higher grit to achieve a finer finish. Avoid skipping grits, as this will leave scratches in the wood.
- Extend the life of the sanding sleeve by regularly using a PRO-STICK® sanding pad (see Accessories on Page 28).
- When bevel sanding, make any necessary guide lines on the longer side of the board so they will be visible during sanding.
- Always turn the sander **ON** and allow it to reach full speed before engaging the workpiece with the sanding sleeve.
- Keep your workpiece moving across the sanding sleeve to prevent burns, grooves or ruts in the workpiece surface.

!WARNING
USE this and other machinery with caution and respect. Always consider safety first, as it applies to your individual working conditions. No list of safety guidelines can be complete—every shop environment is different. Failure to follow guidelines could result in serious personal injury, damage to equipment or poor work results.

Installing Sanding Spindles

The Model W1686 is supplied with ten rubber sanding spindles. Use the larger diameter spindles for sanding large sweeping curves and the smaller spindles for sanding more intricate curves.

When not in use, the spindles are stored on racks located on each side of the machine base, as shown in **Figure 20**. Each spindle is secured to the rack with a hex nut.

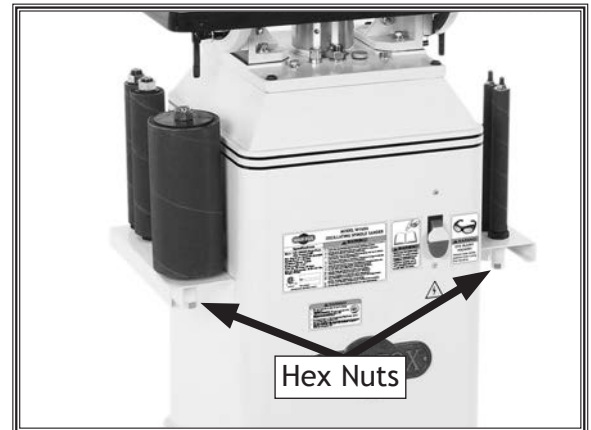

Figure 20. Sanding spindles installed on spindle rack.

To mount spindle for sanding, do these steps:

1. DISCONNECT MACHINE FROM POWER!
2. Determine spindle size needed.
3. Lubricate threads and shaft shown in **Figure 21** with a light oil.

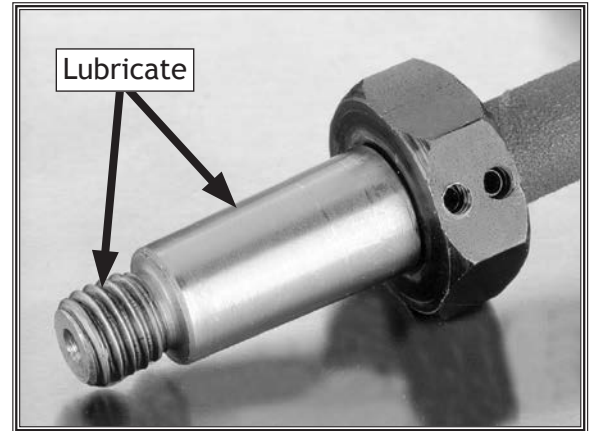

Figure 21. Spindle lubrication points.

4. Insert threaded end of spindle shaft into spindle mounting hole, and screw it down by hand as shown in **Figure 22**.



Figure 22. Mounting spindle.

NOTICE

DO NOT tighten the sanding spindle with a wrench! The sanding action will further tighten the spindle to the sander. Using a wrench could make removal difficult.

To remove spindle, do these steps:

1. DISCONNECT MACHINE FROM POWER!
2. Use one of the supplied wrenches to hold the jam nuts stationary while you loosen the spindle retainer nut, and the spindle will back out as it un-threads (see Figure 23).

Tip: If the spindle has not been removed for some time and is stuck, run the machine until the spindle housing heats up, then retry.

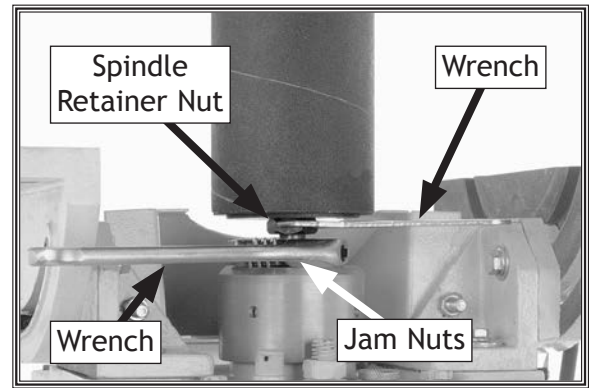

Figure 23. Spindle removal.

Replacing Sanding Sleeves

The Model W1686 is supplied with (10) 100-grit sanding sleeves. Use coarse grits for fast material removal and a rough finish. Use fine grits for slower material removal and a smoother finish. When changing from a coarse sleeve to a finer sleeve on a particular sanding project, avoid increasing the grit number by intervals of more than 50.

To change sanding sleeve on spindles *larger* than 5/8", do these steps:

1. DISCONNECT MACHINE FROM POWER!
2. Loosen hex nut located on top of spindle, as shown in Figure 24. The hex nut and flange disc DO NOT need to be removed.
3. Slide the sanding sleeve off of spindle.
4. Reverse Steps 1-2 to install a sanding sleeve.

To change sanding sleeve on spindles 5/8" and *smaller*, do these steps:

1. DISCONNECT MACHINE FROM POWER!
2. Loosen set screw located in spindle retainer nut (see Figure 25).
3. Slide sanding sleeve off of spindle.
4. Reverse Steps 1-2 to install a sanding sleeve.

NOTICE

Monitor the wear on the sanding sleeves. The upper portion of the sanding sleeve often gets very little use. If this is the case, flip the sanding sleeve over and re-install. This allows maximum use of the sleeve. Worn sanding sleeves will not efficiently remove material and can burn the wood.



Figure 24. Removing sanding sleeve.

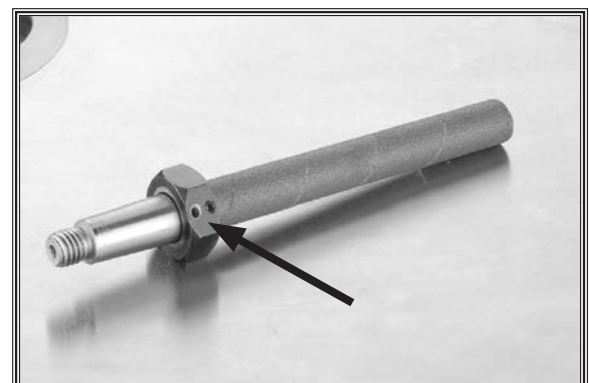

Figure 25. Location of retainer nut set screw.

Installing Table Inserts

The Model W1686 is supplied with three different sized table inserts. The inserts are designed to reduce the gap between the spindle and the table opening. The hole in each insert is oblong to allow clearance when the table is tilted.

NOTICE

Always use the table insert with the smallest opening that still allows at least $\frac{1}{8}$ " clearance around the spindle.

To install table insert, do these steps:

1. DISCONNECT MACHINE FROM POWER!
2. Determine which table insert is best for the particular spindle you are using.
3. Install insert over mounted spindle and into recessed hole on the table, as shown in **Figure 26**. Insert should clear spindle by at least $\frac{1}{8}$ " on all sides.

Note: The insert is fitted with pins that allow it to fit into the table in only one position. This ensures the table insert will not make contact with the spindle even when the table is tilted.

4. Adjust set screws shown in **Figure 27** so top of insert is flush with table surface.



Figure 26. Installing table insert.

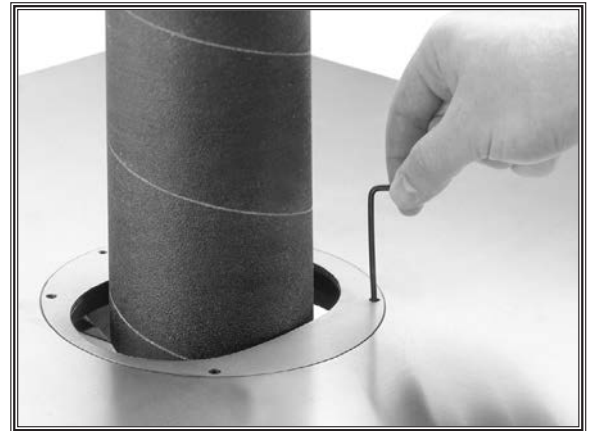

Figure 27. Adjusting table insert.

Contour Sanding

Spindle sanding is typically used for inside curves and irregular shapes. The oscillating spindle moves up and down as it rotates to distribute the scratch pattern so it doesn't leave deep sanding lines. It also helps to avoid burns and maximize sandpaper life.

To sand workpiece, do these steps:

1. Turn sander **ON** and allow spindle to reach full speed.
2. Use both hands to maintain control of workpiece, and guide it against rotation of spindle, as shown in **Figure 28**. DO NOT force workpiece against sanding sleeve. Use light pressure and allow machine to do the work.



Figure 28. Spindle sanding example.

Bevel Sanding

The Model W1686 has a tilting table to allow bevel sanding at a variety of angles. Bevel sanding on a spindle sander is NOT an exact science. When the table is tilted to 45°, the actual angle sanded on the edge of a workpiece will change if the workpiece is sanded at different positions around the spindle.

To bevel sand workpiece, do these steps:

1. DISCONNECT MACHINE FROM POWER!
2. Loosen tilt lock levers (see **Figure 29**) and adjust table to desired angle. Tighten tilt lock levers to secure table in position.
3. Rotate spindle by hand to ensure it does not make contact with table insert.

Note: When marking the finish line on your workpiece, always mark on the outside (or longest) edge of the bevel, as shown in **Figure 30**. This allows the finish line to be viewed on the top side of the workpiece.

4. Turn sander **ON** and allow spindle to reach full speed.
5. Use both hands to maintain control of workpiece, and guide it against rotation of spindle. DO NOT force workpiece against sanding sleeve. Use light pressure and allow machine to do the work.
6. When finished, turn machine **OFF** and return table to zero degree position on scale.

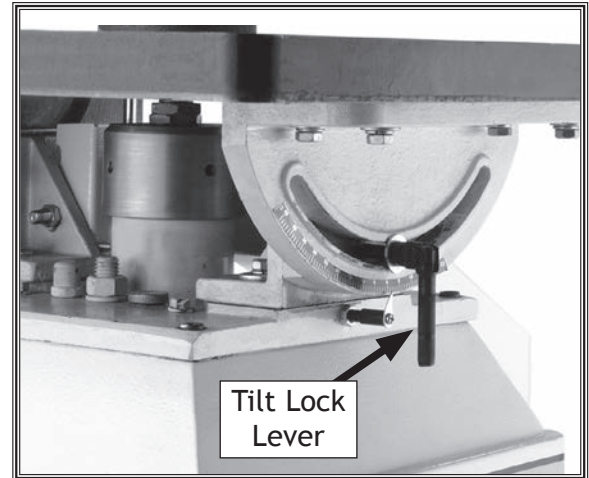

Figure 29. Location of tilt lock levers (1 of 2 shown).

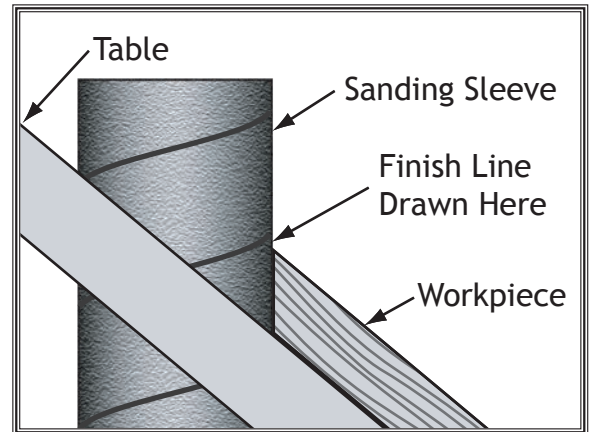

Figure 30. Bevel sanding illustration.

CAUTION

DO NOT operate this machine without an adequate dust collection system. This machine creates substantial amounts of wood dust while operating. Failure to use a dust collection system can result in short and long-term respiratory illness.

ACCESSORIES

Spindle Sander Accessories

The following Spindle Sander accessories may be available through your local Woodstock International Inc. Dealer. If you do not have a dealer in your area, these products are also available through online dealers. Please call or e-mail Woodstock International Inc. Customer Service to get a current listing of dealers at: 1-800-840-8420 or at sales@woodstockint.com.

The Shop Fox® **D2260A Heavy Duty Mobile Base** is designed to give you a stable, mobile platform for mounting machinery and equipment of various sizes and weights. The heavy-duty casters are arranged on outriggers that allow the machine to sit as low as possible and yet be extremely stable. Swivel casters on two corners provide excellent maneuverability. The bolt pattern on the fixed caster side allows orientation of the wheels in two directions. The base can be assembled in any of eight configurations for maximum flexibility. Adjusts from 10¹/₂" x 14¹/₂" to 17¹/₂" x 21¹/₂". 600 lb. maximum capacity.

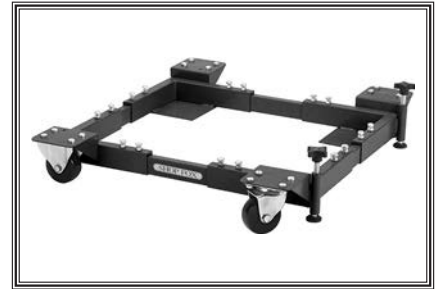

Our **W1396 & W1307 PRO-STIK®** cleaners are the easiest solution for unloading abrasives. Increase the life of new sanding belts and discs with our quality PRO-STIK® abrasive belt cleaners. Simply press the cleaner lightly against moving sanding belts and discs to remove clogged-up pitch and sawdust. Available in four sizes for any cleaning application. (Not recommended for wide-belt sanders.)

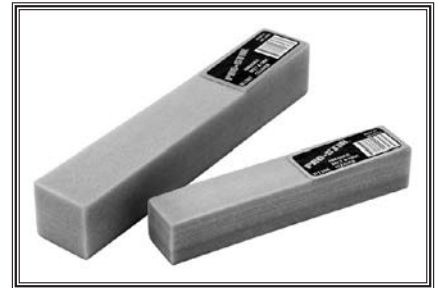

The Shop Fox **D2274 5 Roller Stand** features convenient hand knobs for fast height adjustment. Invaluable for supporting work on machines of varying heights. Adjusts from 26¹/₂" to 44⁵/₈", 15⁷/₈" wide ball bearing rollers, and all-steel construction



Shop Fox offers a huge selection of aluminum-oxide sanding sleeves that are perfect for use with the W1686. Keep plenty of these consumable sanding sleeves on-hand! Sold in 3-packs.



The **D4105 8" Digital Calipers** are constructed of stainless steel and feature an extra-large LCD readout. Accuracy: $\pm 0.001"/0.02\text{mm}$; resolution: $0.0005"/0.01\text{mm}$; SAE and metric with digital display and automatic shutoff.



The **D4089 4 Pc. Machinist's Square Set** is a handy collection to have around. Each square is finely ground steel. All have common beam and blade widths and thicknesses, which allows them to be used in combination with each other. Includes 2", 3", 4", & 6" squares.

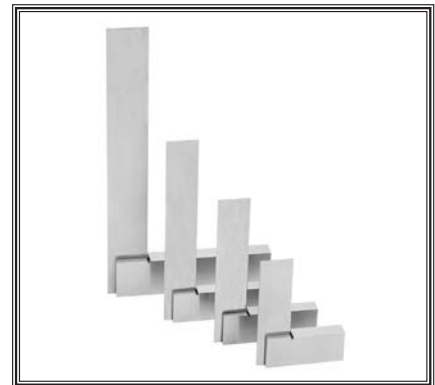

The **W1727 1 HP Dust Collector** is designed for portability. It can be easily moved from one machine to another when needed, instead of having to build an entire fixed dust collection system and running ducts to each machine. CSA certified meeting CSA C22.2 #243-M91 and UL 1017-4th standards!



The **W1849 14" Resaw Bandsaw** is a middle-weight workhorse. European design elements, such as roller disc blade guides, steel column box-frame with rigid "W" shaped spine, and a hinged blade guard enclosure are extras that make this saw a pleasure to use. The cast iron and aluminum extruded fence can be set to the low ($1/2"$) position for close-in detail work, or at 6" for extra support when resawing taller pieces. Add in a storage cabinet for blades, super-efficient dual-port dust collection, a quick-release blade tension lever, and viewing windows for tracking and blade tension settings, and you've got a feature-packed machine with a small footprint and over-sized performance.



MAINTENANCE

General

For optimum performance from this machine, this maintenance schedule must be strictly followed.

Ongoing

To maintain a low risk of injury and proper machine operation, if you ever observe any of the items below, shut down the machine immediately and fix the problem before continuing operations:

- Loose mounting bolts.
- Worn or damaged sanding drums and sleeves.
- Worn or damaged wires.
- Any other unsafe condition.

Weekly Maintenance

- Clean up any sawdust or particle residue from the machine.
- Clean the spindle area and beneath the table insert.
- Check gear oil level. Replace as needed.

Monthly Check

- Clean/vacuum dust buildup from inside the sander body and off of the motor.

Annual Check

- Drain and replace gear oil every 1,000 hours of use (Page 31).

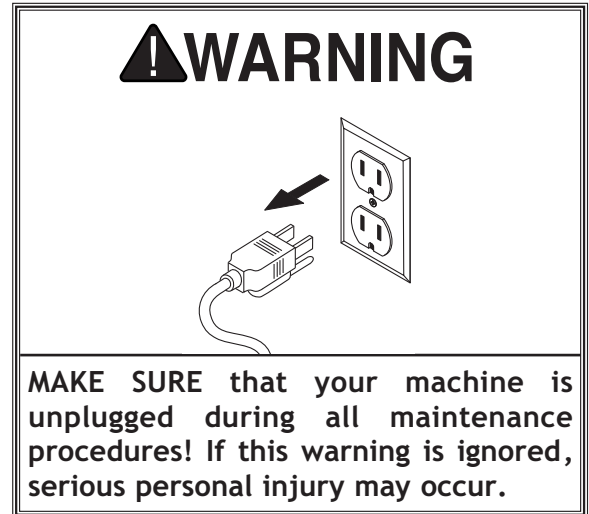

Cleaning & Protecting

Cleaning the Model W1686 is relatively easy. Vacuum excess wood chips and sawdust, and wipe off the remaining dust with a dry cloth. If any resin has built up, use a resin dissolving cleaner to remove it.

Keep tables rust-free with regular applications of quality lubricants.

Changing Gearbox Oil

The spindle gearbox contains 4.5 quarts of 90W gear oil. Replace the gear oil approximately every 1000 hours of use. Remove the fill cap first (see **Figure 31**), then drain the gear oil from the drain plug located inside the sander base at the bottom of the gearbox (see **Figure 32**). When finished, replace the drain plug and fill cap.



Figure 31. Oil fill cap location.

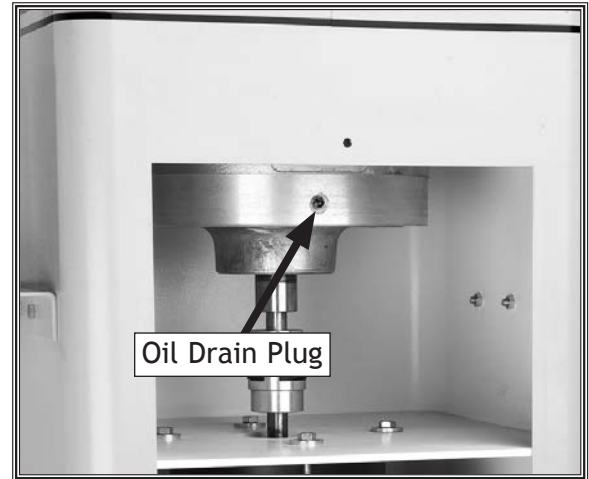

Figure 32. Oil drain plug location.

Cleaning Sanding Sleeves

As sanding sleeves are used, they will become "loaded" with saw dust. If not removed, this saw dust will harden on the abrasive surface, greatly reducing the effectiveness of the sanding sleeve. Routinely clean the sanding sleeves with a rubber gum abrasive cleaner such as the PRO-STIK® cleaners shown in **Figure 33**.

Always discard worn sanding sleeves. As abrasives begin to wear, grit will begin to fall off, causing deep gouges in the workpiece. Glue used to hold the grit to the paper will rub off onto the workpiece, causing burns and interfering with the final finish.



Figure 33. Sanding sleeve maintenance.

MAINTENANCE

SERVICE

Troubleshooting

The following troubleshooting tables cover common problems that may occur with this machine. If you need replacement parts or additional troubleshooting help, contact our Technical Support.

Note: Before contacting Tech Support, find the machine serial number and manufacture date, and if available, your original purchase receipt. This information is required to properly assist you.

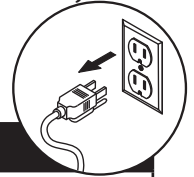

Motor and Electrical

PROBLEM	POSSIBLE CAUSE	CORRECTIVE ACTION
Machine does not start, or power supply breaker trips immediately after startup.	<ol style="list-style-type: none"> 1. Switch disabling key removed. 2. Power supply circuit breaker tripped or fuse blown. 3. Wiring open/has high resistance. 4. Start capacitor at fault. 5. ON/OFF switch at fault. 6. Motor at fault. 	<ol style="list-style-type: none"> 1. Install switch disabling key. 2. Ensure circuit is sized correctly and free of shorts. Resent circuit breaker/replace fuse. 3. Check/fix broken, disconnected, or corroded wires. 4. Test/replace. 5. Test/replace. 6. Test/repair/replace.
Machine stalls or is underpowered.	<ol style="list-style-type: none"> 1. Sanding sleeve loaded up. 2. Sanding sleeve worn or damaged. 3. Machine undersized for task. 4. Motor overheated. 5. Motor at fault. 6. Motor bearings at fault. 	<ol style="list-style-type: none"> 1. Clean sanding sleeve (Page 31). 2. Replace sanding sleeve (Page 25). 3. Reduce feed rate/workpiece pressure. 4. Clean motor, let cool, and reduce workload. 5. Test/repair/replace. 6. Test/repair/replace.
Machine has vibration or noisy operation.	<ol style="list-style-type: none"> 1. Sanding sleeve out of balance or loose. 2. Motor or component loose. 3. Motor bearings at fault. 	<ol style="list-style-type: none"> 1. Ensure sanding sleeve is properly installed (Page 25). 2. Retighten loose bolts/nuts; replace if damaged. 3. Test by rotating shaft; rotational grinding/loose shaft requires bearing replacement.

Sanding Operations

PROBLEM	POSSIBLE CAUSE	CORRECTIVE ACTION
Sanding grains easily rub off sleeve.	<ol style="list-style-type: none"> 1. Sanding sleeve has been stored in an incorrect environment. 2. Sanding sleeve has been smashed or folded. 	<ol style="list-style-type: none"> 1. Replace damaged sanding sleeve (Page 25). Store sanding sleeve in a cool, dry area. 2. Replace damaged sanding sleeve (Page 25). Do not bend or fold sanding sleeves.
Deep sanding grooves or scars in workpiece.	<ol style="list-style-type: none"> 1. Excessive feed pressure while sanding. 2. Workpiece held in one place against sleeve for too long. 3. Sanding sleeve too coarse. 	<ol style="list-style-type: none"> 1. Reduce feed rate/workpiece pressure. 2. Keep workpiece moving while sanding. 3. Use finer grit sanding sleeve.
Sanding sleeve clogs quickly.	<ol style="list-style-type: none"> 1. Excessive feed pressure while sanding. 2. Sanding softwood or wood with a high amount of pitch. 3. Sanding sleeve worn or damaged. 	<ol style="list-style-type: none"> 1. Clean sanding sleeve (Page 31), and then reduce feed rate/workpiece pressure. 2. Use different stock, or accept characteristics of stock and plan to clean/replace sanding sleeve frequently. 3. Replace sanding sleeve (Page 25).
Glazed sanding surface.	<ol style="list-style-type: none"> 1. Workpiece has excessive moisture. 2. Workpiece has high amount of residue. 	<ol style="list-style-type: none"> 1. Only sand dry stock with moisture content below 20%. 2. Use different stock, or accept characteristics of stock and plan to clean/replace sanding sleeve frequently.
Burn marks on workpiece.	<ol style="list-style-type: none"> 1. Sanding grit too fine. 2. Excessive feed pressure while sanding. 3. Workpiece held in one place against sleeve for too long. 4. Sanding sleeve loaded up. 5. Sanding sleeve worn or damaged. 	<ol style="list-style-type: none"> 1. Use coarser grit sanding sleeve. 2. Reduce feed rate/workpiece pressure. 3. Keep workpiece moving while sanding. 4. Clean sanding sleeve (Page 31). 5. Replace sanding sleeve (Page 25).

Electrical Safety Instructions

These pages are current at the time of printing. However, in the spirit of improvement, we may make changes to the electrical systems of future machines. Compare the manufacture date of your machine to the one stated in this manual, and study this section carefully.

If there are differences between your machine and what is shown in this section, call Technical Support at (360) 734-3482 for assistance BEFORE making any changes to the wiring on your machine. An updated wiring diagram may be available. **Note:** Please gather the serial number and manufacture date of your machine before calling. This information can be found on the main machine label.

⚠ WARNING

SHOCK HAZARD. Working on wiring that is connected to a power source is extremely dangerous. Touching electrified parts will result in personal injury including but not limited to severe burns, electrocution, or death. Disconnect the power from the machine before servicing electrical components!

QUALIFIED ELECTRICIAN. Due to the inherent hazards of electricity, only a qualified electrician should perform wiring tasks on this machine. If you are not a qualified electrician, get help from one before attempting any kind of wiring job.

WIRE CONNECTIONS. All connections must be tight to prevent wires from loosening during machine operation. Double-check all wires disconnected or connected during any wiring task to ensure tight connections.

WIRE/COMPONENT DAMAGE. Damaged wires or components increase the risk of serious personal injury, fire, or machine damage. If you notice that any wires or components are damaged while performing a wiring task, replace those wires or components before completing the task.

MODIFICATIONS. Using aftermarket parts or modifying the wiring beyond what is shown in the diagram may lead to unpredictable results, including serious injury or fire.

MOTOR WIRING. The motor wiring shown in these diagrams is current at the time of printing, but it may not match your machine. Always use the wiring diagram inside the motor junction box.

CAPACITORS/INVERTERS. Some capacitors and power inverters store an electrical charge for up to 10 minutes after being disconnected from the power source. To reduce the risk of being shocked, wait at least this long before working on capacitors.

CIRCUIT REQUIREMENTS. You MUST follow the requirements at the beginning of this manual when connecting your machine to a power source.

EXPERIENCING DIFFICULTIES. If you are experiencing difficulties understanding the information included in this section, contact our Technical Support at (360) 734-3482.

NOTICE

The photos and diagrams included in this section are best viewed in color. You can view these pages in color at www.shopfox.biz.

WIRING DIAGRAM COLOR KEY

BLACK — Bk	BLUE — Bl	YELLOW — Yl	LIGHT BLUE — Lb
WHITE — Wt	BROWN — Br	YELLOW GREEN — Yg	BLUE WHITE — Bw
GREEN — Gn	GRAY — Gy	PURPLE — Pu	TUR-QUOISE — Tu
RED — Rd	ORANGE — Or	PINK — Pk	

Wiring Diagram

NOTICE
 This motor wiring diagram is current at the time of printing. However, always use the diagram on the inside of the junction box when rewiring your motor!

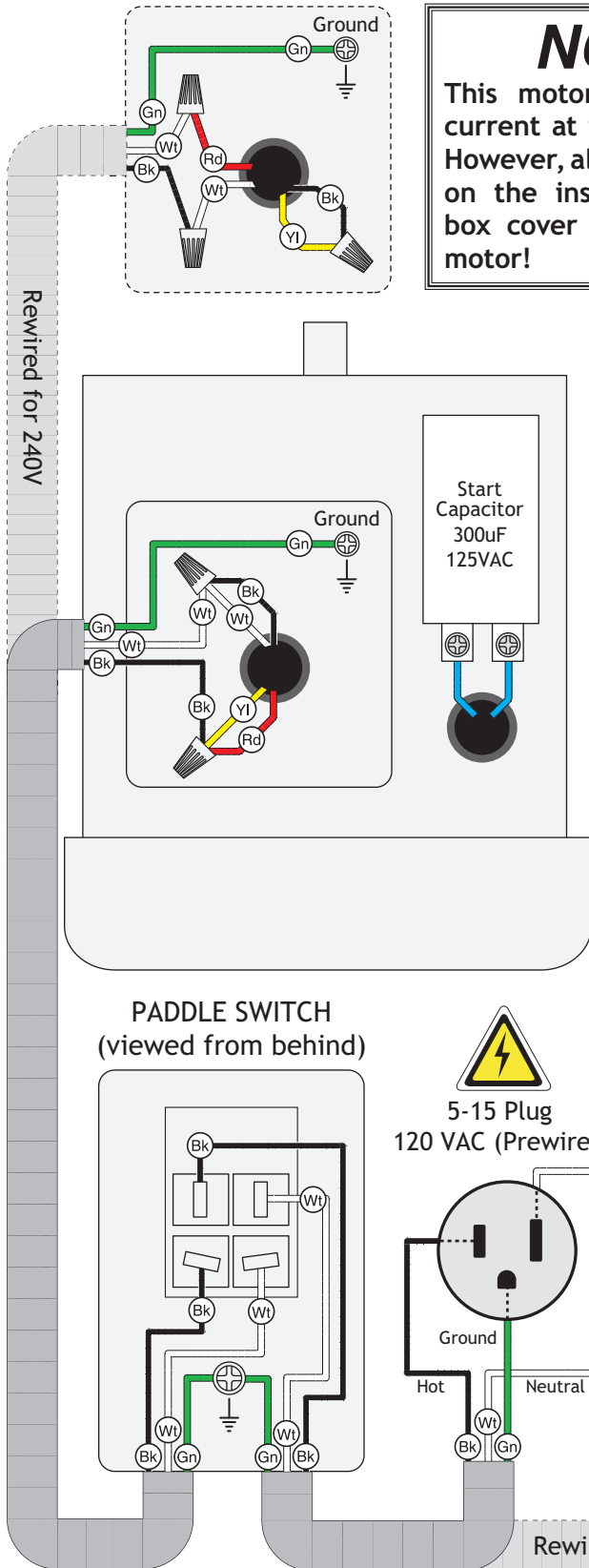

Figure 34. Motor wiring 240V.



Figure 35. Motor wiring 120V.



Figure 36. Start capacitor.



Figure 37. ON/OFF switch wiring.

SERVICE

Main Parts List

REF	PART #	DESCRIPTION
2	X1686002	CAP SCREW 5/16-18 X 1
5	X1686005	SHOP FOX NAMEPLATE-MEDIUM
6	X1686006	INSERT 4-1/4" X 6"
7	X1686007	DUST COVER
8	X1686008	KEY 5 X 5 X 25
11	X1686011	TABLE
12	X1686012	INSERT, 1-3/4" X 2-3/16"
13	X1686013	INSERT, 2-3/16" X 3-1/2"
14	X1686014	BRACKET
15	X1686015	TRUNNION
16	X1686016	INNER TRUNNION
17	X1686017	4" DUST CHUTE
18	X1686018	HOUSING CASTING
19	X1686019	DIPSTICK
20	X1686020	SPINDLE CASTING
21	X1686021	COVER
22	X1686022	SPINDLE
23	X1686023	SPINDLE KEY 5 X 5 X 20
24	X1686024	SPINDLE RETAINER
25	X1686025	SPINDLE NUT
26	X1686026	WORM
27	X1686027	MOUNTING BRACKET
28	X1686028	BEARING BLOCK
29	X1686029	WORM GEAR 24T
30	X1686030	CONNECTING ROD
31	X1686031	WRIST PIN
32	X1686032	DRIVE SHAFT
33	X1686033	HUB
34	X1686034	CENTER BLOCK
35V2	X1686035V2	CASE V2.08.02
35-1	X1686035-1	RUBBER STRIP
45	X1686045	GUIDE SHAFT
64	X1686064	TABLE STOP BOLT 3/8-16 X 6-1/2
70	X1686070	POINTER
71	X1686071	POINTER MOUNT
72	X1686072	CABINET
75	X1686075	DOOR
76	X1686076	LOCK HANDLE
77	X1686077	SCALE
78	X1686078	RIVET
79	X1686079	OIL BREATHER
80	X1686080	KNOB 1/4"-20 X 1"
81	X1686081	GASKET
82	X1686082	SHOP FOX PADDLE SWITCH 125V/250V
83V2	X1686083V2	MOTOR CORD 16AWG 3W 30" V2.11.10
84V2	X1686084V2	PWR CORD 16AWG 3W 5-15P V2.11.10

REF	PART #	DESCRIPTION
85	X1686085	STRAIN RELIEF TYPE-3 M20-1.5
86	X1686086	MOTOR 1HP 120V/240V 1PH
86-1	X1686086-1	MOTOR FAN COVER
86-2	X1686086-2	MOTOR FAN
86-3	X1686086-3	CONTACT PLATE
86-4	X1686086-4	MOTOR JUNCTION BOX
86-5	X1686086-5	CENTRIFUGAL SWITCH
86-6	X1686086-6	S CAPACITOR 300M 125V
86-7	X1686086-7	BALL BEARING 6204ZZ (FRONT)
86-8	X1686086-8	BALL BEARING 6202ZZ (REAR)
90	X1686090	HEX BOLT 3/8-16 X 1-1/4
91	X1686091	HEX BOLT 3/8-16 X 1
92	X1686092	LOCK WASHER 3/8
93	X1686093	SET SCREW 1/4-20 X 5/8
94	X1686094	ROLL PIN 5 X 28
95	X1686095	FLAT WASHER 3/8
96	X1686096	HEX NUT 5/16-18
97	X1686097	CAP SCREW 10-32 X 3/8
98	X1686098	HEX BOLT 3/8-16 X 1-1/2
99	X1686099	HEX NUT 3/8-16
100	X1686100	CAP SCREW 5/16-18 X 1
101	X1686101	LOCK WASHER 5/16
102	X1686102	CAP SCREW 3/8-16 X 3/4
103	X1686103	HEX BOLT 3/8-16 X 1-1/4
104	X1686104	BALL BEARING 6206ZZ
105	X1686105	SEAL 30-62-8
106	X1686106	INT RETAINING RING 62MM
107	X1686107	BALL BEARING 6205-2RS
108	X1686108	CAP SCREW 5-40 X 1/2
109	X1686109	ROLL PIN 5 X 30
110	X1686110	KEY 5 X 5 X 25
111	X1686111	SET SCREW 5/16-18 X 3/8
112	X1686112	DRAIN PLUG
113	X1686113	HEX NUT 5/8-11
114	X1686114	LOCK WASHER 5/8
117	X1686117	HEX BOLT 5/16-18 X 1
118	X1686118	FENDER WASHER 5/16
122	X1686122	PHLP HD SCR 10-24 X 1
123V2	X1686123V2	MACHINE ID LABEL V2.11.10
124	X1686124	SAFETY GLASSES LABEL
125	X1686125	READ MANUAL LABEL
126	X1686126	ELECTRICITY LABEL
128	X1686128	DAMPNESS EXPOSURE LABEL
129	X1686129	CHECK OIL LABEL
130	X1686130	TAP SCREW M3 X 10

WARNING

Safety labels warn about machine hazards and how to prevent serious personal injury. The owner of this machine **MUST** maintain the original location and readability of all labels on this machine. If any label is removed or becomes unreadable, **REPLACE** that label before allowing machine to be operated again. Contact us at (360) 734-3482 or www.woodstockint.com to order new labels.



Warranty Registration

Name _____
 Street _____
 City _____ State _____ Zip _____
 Phone # _____ Email _____ Invoice # _____
 Model # _____ Serial # _____ Dealer Name _____ Purchase Date _____

The following information is given on a voluntary basis. It will be used for marketing purposes to help us develop better products and services. Of course, all information is strictly confidential.

- How did you learn about us?
 Advertisement Friend Local Store
 Mail Order Catalog Website Other:
- How long have you been a woodworker/metalworker?
 0-2 Years 2-8 Years 8-20 Years 20+ Years
- How many of your machines or tools are Shop Fox?
 0-2 3-5 6-9 10+
- Do you think your machine represents a good value? Yes No
- Would you recommend Shop Fox products to a friend? Yes No
- What is your age group?
 20-29 30-39 40-49
 50-59 60-69 70+
- What is your annual household income?
 \$20,000-\$29,000 \$30,000-\$39,000 \$40,000-\$49,000
 \$50,000-\$59,000 \$60,000-\$69,000 \$70,000+
- Which of the following magazines do you subscribe to?

<input type="checkbox"/> Cabinet Maker	<input type="checkbox"/> Popular Mechanics	<input type="checkbox"/> Today's Homeowner
<input type="checkbox"/> Family Handyman	<input type="checkbox"/> Popular Science	<input type="checkbox"/> Wood
<input type="checkbox"/> Hand Loader	<input type="checkbox"/> Popular Woodworking	<input type="checkbox"/> Wooden Boat
<input type="checkbox"/> Handy	<input type="checkbox"/> Practical Homeowner	<input type="checkbox"/> Woodshop News
<input type="checkbox"/> Home Shop Machinist	<input type="checkbox"/> Precision Shooter	<input type="checkbox"/> Woodsmith
<input type="checkbox"/> Journal of Light Cont.	<input type="checkbox"/> Projects in Metal	<input type="checkbox"/> Woodwork
<input type="checkbox"/> Live Steam	<input type="checkbox"/> RC Modeler	<input type="checkbox"/> Woodworker West
<input type="checkbox"/> Model Airplane News	<input type="checkbox"/> Rifle	<input type="checkbox"/> Woodworker's Journal
<input type="checkbox"/> Modeltec	<input type="checkbox"/> Shop Notes	<input type="checkbox"/> Other:
<input type="checkbox"/> Old House Journal	<input type="checkbox"/> Shotgun News	

9. Comments: _____

CUT ALONG DOTTED LINE

FOLD ALONG DOTTED LINE

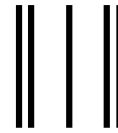
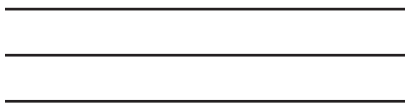

Place
Stamp
Here



WOODSTOCK INTERNATIONAL INC.
P.O. BOX 2309
BELLINGHAM, WA 98227-2309



FOLD ALONG DOTTED LINE

TAPE ALONG EDGES--PLEASE DO NOT STAPLE

WARRANTY

Woodstock International, Inc. warrants all Shop Fox machinery to be free of defects from workmanship and materials for a period of two years from the date of original purchase by the original owner. This warranty does not apply to defects due directly or indirectly to misuse, abuse, negligence or accidents, lack of maintenance, or reimbursement of third party expenses incurred.

Woodstock International, Inc. will repair, replace, or arrange for a dealer refund, at its expense and option, the Shop Fox machine or machine part proven to be defective for its designed and intended use, provided that the original owner returns the product prepaid to an authorized warranty or repair facility as designated by our Bellingham, Washington office with proof of their purchase of the product within two years, and provides Woodstock International, Inc. reasonable opportunity to verify the alleged defect through inspection. If it is determined there is no defect, or that the defect resulted from causes not within the scope of Woodstock International Inc.'s warranty, then the original owner must bear the cost of storing and returning the product.

This is Woodstock International, Inc.'s sole written warranty and any and all warranties that may be implied by law, including any merchantability or fitness, for any particular purpose, are hereby limited to the duration of this written warranty. We do not warrant that Shop Fox machinery complies with the provisions of any law, acts or electrical codes. We do not reimburse for third party repairs. In no event shall Woodstock International, Inc.'s liability under this limited warranty exceed the purchase price paid for the product, and any legal actions brought against Woodstock International, Inc. shall be tried in the State of Washington, County of Whatcom. We shall in no event be liable for death, injuries to persons or property or for incidental, contingent, special or consequential damages arising from the use of our products.

Every effort has been made to ensure that all Shop Fox machinery meets high quality and durability standards. We are committed to continuously improving the quality of our products, and reserve the right to change specifications at any time.



High Quality Machines and Tools

Woodstock International, Inc. carries thousands of products designed to meet the needs of today's woodworkers and metalworkers.

Ask your dealer about these fine products:

BROSWA
PRECISION STOP BLOCK

JOINTER PAL[®]

Rotacator[®]

THE REBEL[®]

DURASTICK[®]

Gutmann[®]

BOARD BUDDIES[®]

Junglee[®]

PLANER PAL[®]



PARROT VISE[®]

SLICKPLANE[®]

PRO-STIK[®]
ABRASIVE BELT & DISC CLEANER

ACCU-SHARP[®]



STEELEX[®]
PLUS

STEELEX[®]
FINE TOOLS

Aluma-Classic[®]

WHOLESALE ONLY

WOODSTOCK INTERNATIONAL, INC.

Phone: (360) 734-3482 • Fax: (360) 671-3053 • Toll Free Fax: (800) 647-8801

P.O.Box 2309 • Bellingham, WA 98227

SHOPFOX.BIZ