

# *Grizzly* **Industrial, Inc.**®

## MODEL H2935/H2936 DOWNDRAFT TABLE

### OWNER'S MANUAL

*(For models manufactured since 10/22)*



H2935 Shown



COPYRIGHT © MAY, 2006 BY GRIZZLY INDUSTRIAL, INC., REVISED JANUARY, 2023 (BL)

**WARNING: NO PORTION OF THIS MANUAL MAY BE REPRODUCED IN ANY SHAPE OR FORM WITHOUT THE WRITTEN APPROVAL OF GRIZZLY INDUSTRIAL, INC.**

#BL8221 PRINTED IN TAIWAN

V5.01.23

**\*\*\*Keep for Future Reference\*\*\***



## **WARNING!**

**This manual provides critical safety instructions on the proper setup, operation, maintenance, and service of this machine/tool. Save this document, refer to it often, and use it to instruct other operators.**

**Failure to read, understand and follow the instructions in this manual may result in fire or serious personal injury—including amputation, electrocution, or death.**

**The owner of this machine/tool is solely responsible for its safe use. This responsibility includes but is not limited to proper installation in a safe environment, personnel training and usage authorization, proper inspection and maintenance, manual availability and comprehension, application of safety devices, cutting/sanding/grinding tool integrity, and the usage of personal protective equipment.**

**The manufacturer will not be held liable for injury or property damage from negligence, improper training, machine modifications or misuse.**



## **WARNING!**

**Some dust created by power sanding, sawing, grinding, drilling, and other construction activities contains chemicals known to the State of California to cause cancer, birth defects or other reproductive harm. Some examples of these chemicals are:**

- **Lead from lead-based paints.**
- **Crystalline silica from bricks, cement and other masonry products.**
- **Arsenic and chromium from chemically-treated lumber.**

**Your risk from these exposures varies, depending on how often you do this type of work. To reduce your exposure to these chemicals: Work in a well ventilated area, and work with approved safety equipment, such as those dust masks that are specially designed to filter out microscopic particles.**

# Table of Contents

- INTRODUCTION..... 2**
  - Contact Info..... 2
  - Manual Accuracy..... 2
  - Identification ..... 3
  - H2935 Machine Data Sheet..... 4
  - H2936 Machine Data Sheet..... 6
  
- SECTION 1: SAFETY ..... 8**
  - Safety Instructions for Machinery..... 8
  - Additional Safety for Downdraft Tables..... 10
  
- SECTION 2: POWER SUPPLY ..... 11**
  
- SECTION 3: SETUP ..... 13**
  - Needed for Setup ..... 13
  - Unpacking ..... 13
  - Inventory..... 14
  - Site Considerations ..... 15
  - Lifting & Placing ..... 16
  - Assembly..... 16
  - Test Run..... 19
  
- SECTION 4: OPERATIONS ..... 20**
  - Operation..... 20
  - Resetting Circuit Breaker ..... 20
  
- SECTION 5: MAINTENANCE..... 21**
  - Schedule ..... 21
  - Cleaning ..... 21
  - Emptying Dust Drawer ..... 21
  - Servicing Filters..... 22
  - Accessories ..... 22
  
- SECTION 6: SERVICE ..... 23**
  - Troubleshooting..... 23
  
- SECTION 7: WIRING..... 24**
  - Wiring Safety Instructions ..... 24
  - H2935 Wiring Diagram..... 25
  - H2936 Wiring Diagram..... 26
  - H2935/H2936 Electrical Components ..... 27
  
- SECTION 8: PARTS ..... 28**
  - H2935 Main ..... 28
  - H2936 Main ..... 30
  - Labels & Cosmetics ..... 32
  
- WARRANTY & RETURNS ..... 33**

# INTRODUCTION

## Contact Info

We stand behind our machines! If you have questions or need help, contact us with the information below. Before contacting, make sure you get the **serial number** and **manufacture date** from the machine ID label. This will help us help you faster.

Grizzly Technical Support  
1815 W. Battlefield  
Springfield, MO 65807  
Phone: (570) 546-9663  
Email: techsupport@grizzly.com

We want your feedback on this manual. What did you like about it? Where could it be improved? Please take a few minutes to give us feedback.

Grizzly Documentation Manager  
P.O. Box 2069  
Bellingham, WA 98227-2069  
Email: manuals@grizzly.com

### **WARNING**

Like all machinery there is potential danger when operating this machine. Accidents are frequently caused by lack of familiarity or failure to pay attention. Use this machine with respect and caution to decrease the risk of operator injury. If normal safety precautions are overlooked or ignored, serious personal injury may occur.

### **CAUTION**

No list of safety guidelines can be complete. Every shop environment is different. Always consider safety first, as it applies to your individual working conditions. Use this and other machinery with caution and respect. Failure to do so could result in serious personal injury, damage to equipment, or poor work results.



## Manual Accuracy

We are proud to provide a high-quality owner's manual with your new machine!

We made every effort to be exact with the instructions, specifications, drawings, and photographs in this manual. Sometimes we make mistakes, but our policy of continuous improvement also means that **sometimes the machine you receive is slightly different than shown in the manual.**

If you find this to be the case, and the difference between the manual and machine leaves you confused or unsure about something, check our website for an updated version. We post current manuals and manual updates for free on our website at [www.grizzly.com](http://www.grizzly.com).

Alternatively, you can call our Technical Support for help. Before calling, make sure you write down the **manufacture date** and **serial number** from the machine ID label (see below). This information is required for us to provide proper tech support, and it helps us determine if updated documentation is available for your machine.

		MODEL GXXXX MACHINE NAME	
SPECIFICATIONS		 <b>WARNING!</b>	
Motor:		To reduce risk of serious injury when using this machine:	
Specification:		1. Read manual before operation.	
Specification:		2. Wear safety glasses and respirator.	
Specification:		3. Make sure power is connected to grounded circuit before starting.	
Specification:		4. Make sure the motor has stopped and disconnect power before adjustments, maintenance, or service.	
Weight:		5. DO NOT expose to rain or dampness.	
		6. DO NOT modify this machine in any way.	
		7.	
		8.	
		9. Do not use while under the influence of drugs or alcohol.	
		10. Maintain machine carefully to prevent accidents.	
Manufactured for Grizzly in Taiwan			

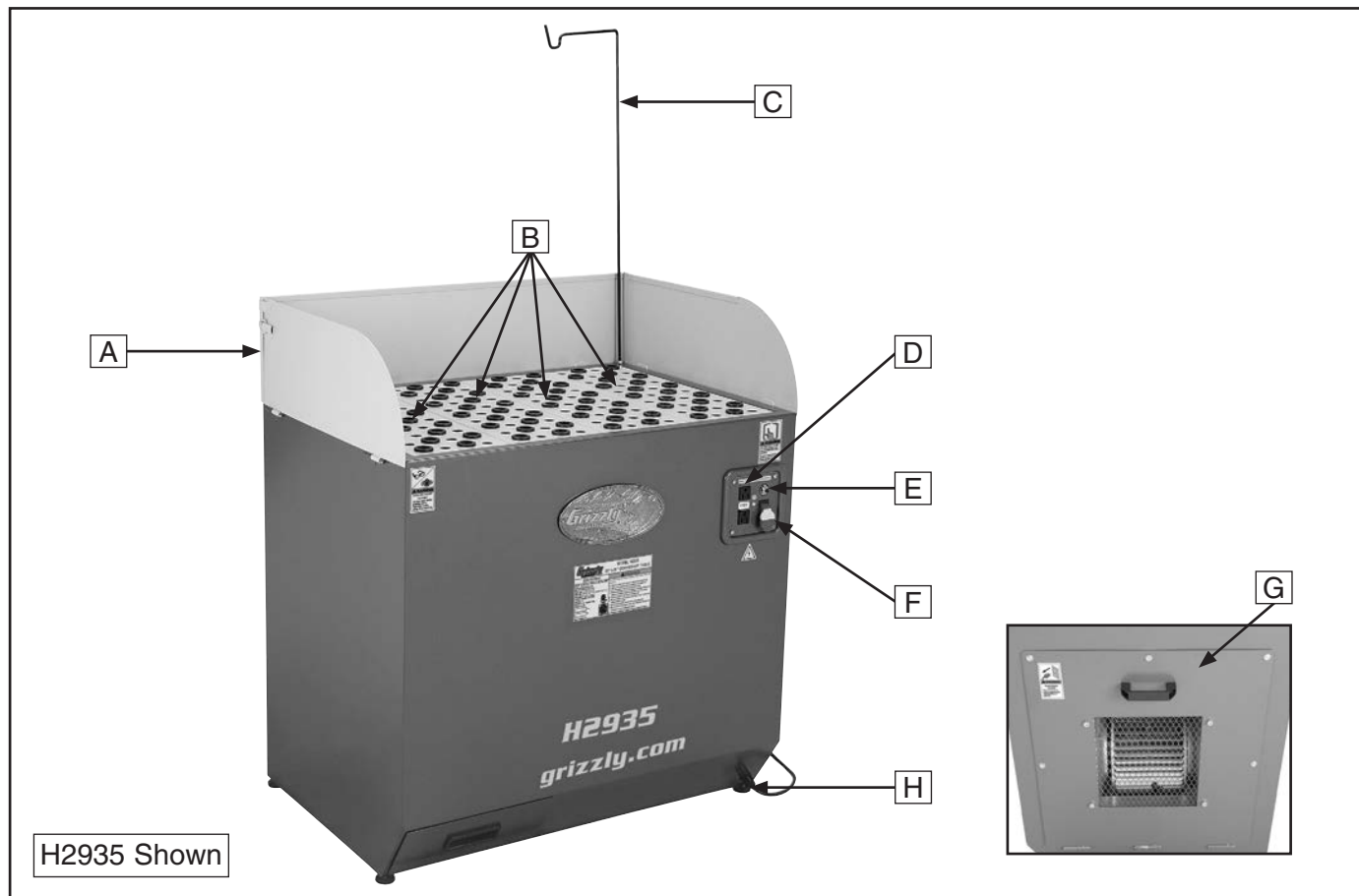
Manufacture Date: [ ]

Serial Number: [ ]



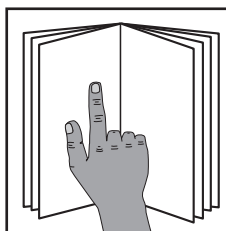
# Identification

Become familiar with the names and locations of the controls and features shown below to better understand the instructions in this manual.



- A. Side Panel
- B. Downdraft Plates
- C. Cord Hanger
- D. 120V Outlets

- E. Reset Button
- F. ON/OFF Switch
- G. Outlet Plate
- H. Foot Pad



## **!WARNING**

To reduce your risk of serious injury, read this entire manual **BEFORE** using machine.





# MACHINE DATA SHEET

Customer Service #: (570) 546-9663 · To Order Call: (800) 523-4777 · Fax #: (800) 438-5901

## MODEL H2935 23" X 31" DOWNDRAFT TABLE

### Product Dimensions:

Weight..... 189 lbs.  
 Width (side-to-side) x Depth (front-to-back) x Height..... 33-3/4 x 23-1/2 x 39-3/8 in.  
 Footprint (Length x Width)..... 23-1/2 x 33-3/4 in.

### Shipping Dimensions:

Type..... Cardboard Box on Wood Skids  
 Content..... Machine  
 Weight..... 208 lbs.  
 Length x Width x Height..... 26 x 36 x 36 in.  
 Must Ship Upright..... No

### Electrical:

Power Requirement..... 120V, Single-Phase, 60 Hz  
 Full-Load Current Rating..... 7.5A  
 Minimum Circuit Size..... 15A  
 Connection Type..... Cord & Plug  
 Power Cord Included..... Yes  
 Power Cord Length..... 12 ft.  
 Power Cord Gauge..... 14 AWG  
 Plug Included..... Yes  
 Included Plug Type..... 5-15  
 Switch Type..... Paddle Safety Switch w/Removable Key

### Motors:

#### Main

Horsepower..... 1/3 HP  
 Phase..... Single-Phase  
 Amps..... 7.5A  
 Speed..... 1720 RPM  
 Type..... ODP Permanent-Split Capacitor  
 Power Transfer..... Direct Drive  
 Bearings..... Shielded & Permanently Lubricated

### Main Specifications:

#### Operation Info

Air Suction Capacity..... 1300 CFM  
 First Stage Filter Micron..... 1  
 Second Stage Filter Micron..... 0.3  
 Filter Efficiency..... 25-30 Percent ASHRAE 52.1  
 Impeller Type..... Squirrel Cage  
 Impeller Size..... 9-1/2 in.



**Filter Info**

Number of First Stage Filters.....	1
First Stage Filter Length.....	20 in.
First Stage Filter Width.....	16 in.
First Stage Filter Thickness.....	1 in.
Number of Second Stage Filters.....	1
Second Stage Filter Length.....	20 in.
Second Stage Filter Width.....	16 in.
Second Stage Filter Thickness.....	2 in.

**Table Info**

Table Size Length.....	31-1/2 in.
Table Size Width.....	23-1/2 in.
Floor to Table Height.....	32 in.
Number of Table Inserts.....	88
Table Insert Diameter.....	1-3/8 in.

**Construction Info**

Frame.....	Pre-Formed Steel
Base.....	Pre-Formed Steel on Casters
Impeller.....	Heavy-Duty Plastic
Table.....	Sheet Metal
Side Wall.....	Steel
Filter.....	Woven Fabric
Table Inserts.....	Rubber
Paint Type/Finish.....	Powder Coated

**Other Specifications:**

Country of Origin .....	Taiwan
Warranty .....	1 Year
Approximate Assembly & Setup Time .....	15 Minutes
Serial Number Location .....	ID Label
ISO 9001 Factory .....	Yes
Certified by a Nationally Recognized Testing Laboratory (NRTL) .....	Yes

**Features:**

- Non-Marring Rubber Support Grommets
- Easy Access Filter Bay
- Quiet Operation
- Power Cord Hanger
- Two 120V Outlets for Hand-Held Sanders





# MACHINE DATA SHEET

Customer Service #: (570) 546-9663 · To Order Call: (800) 523-4777 · Fax #: (800) 438-5901

## MODEL H2936 28" X 39" DOWNDRAFT TABLE

### Product Dimensions:

Weight..... 209 lbs.  
 Width (side-to-side) x Depth (front-to-back) x Height..... 39-3/8 x 28 x 39-3/8 in.  
 Footprint (Length x Width)..... 28 x 39-3/8 in.

### Shipping Dimensions:

Type..... Cardboard Box on Wood Skids  
 Content..... Machine  
 Weight..... 252 lbs.  
 Length x Width x Height..... 30 x 41 x 36 in.  
 Must Ship Upright..... No

### Electrical:

Power Requirement..... 120V, Single-Phase, 60 Hz  
 Full-Load Current Rating..... 8.5A  
 Minimum Circuit Size..... 15A  
 Connection Type..... Cord & Plug  
 Power Cord Included..... Yes  
 Power Cord Length..... 12 ft.  
 Power Cord Gauge..... 14 AWG  
 Plug Included..... Yes  
 Included Plug Type..... 5-15  
 Switch Type..... Paddle Safety Switch w/Removable Key

### Motors:

#### Main

Horsepower..... 1/2 HP  
 Phase..... Single-Phase  
 Amps..... 8.5A  
 Speed..... 1720 RPM  
 Type..... ODP Permanent-Split Capacitor  
 Power Transfer ..... Direct Drive  
 Bearings..... Shielded & Permanently Lubricated

### Main Specifications:

#### Operation Info

Air Suction Capacity..... 1490 CFM  
 First Stage Filter Micron..... 1  
 Second Stage Filter Micron..... 0.3  
 Filter Efficiency..... 25-30 Percent ASHRAE 52.1  
 Impeller Type..... Squirrel Cage  
 Impeller Size..... 9-1/2 in.





**Filter Info**

Number of First Stage Filters.....	1
First Stage Filter Length.....	25 in.
First Stage Filter Width.....	16 in.
First Stage Filter Thickness.....	1 in.
Number of Second Stage Filters.....	1
Second Stage Filter Length.....	25 in.
Second Stage Filter Width.....	16 in.
Second Stage Filter Thickness.....	2 in.

**Table Info**

Table Size Length.....	37 in.
Table Size Width.....	28 in.
Floor to Table Height.....	32 in.
Number of Table Inserts.....	110
Table Insert Diameter.....	1-3/8 in.

**Construction Info**

Frame.....	Pre-Formed Steel
Base.....	Pre-Formed Steel on Casters
Impeller.....	Heavy-Duty Plastic
Table.....	Sheet Metal
Side Wall.....	Steel
Filter.....	Woven Fabric
Table Inserts.....	Rubber
Paint Type/Finish.....	Powder Coated

**Other Specifications:**

Country of Origin .....	Taiwan
Warranty .....	1 Year
Approximate Assembly & Setup Time .....	30 Minutes
Serial Number Location .....	ID Label
ISO 9001 Factory .....	Yes
Certified by a Nationally Recognized Testing Laboratory (NRTL) .....	Yes

**Features:**

- Non-Marring Rubber Support Grommets
- Easy Access Filter Bay
- Quiet Operation
- Power Cord Hanger
- Two 120V Outlets for Hand-Held Sanders



# SECTION 1: SAFETY

## For Your Own Safety, Read Instruction Manual Before Operating This Machine

The purpose of safety symbols is to attract your attention to possible hazardous conditions. This manual uses a series of symbols and signal words intended to convey the level of importance of the safety messages. The progression of symbols is described below. Remember that safety messages by themselves do not eliminate danger and are not a substitute for proper accident prevention measures. Always use common sense and good judgment.

**⚠ DANGER** Indicates an imminently hazardous situation which, if not avoided, **WILL** result in death or serious injury.

**⚠ WARNING** Indicates a potentially hazardous situation which, if not avoided, **COULD** result in death or serious injury.

**⚠ CAUTION** Indicates a potentially hazardous situation which, if not avoided, **MAY** result in minor or moderate injury. It may also be used to alert against unsafe practices.

**NOTICE** Alerts the user to useful information about proper operation of the machine to avoid machine damage.

## Safety Instructions for Machinery

### ⚠ WARNING

**OWNER'S MANUAL.** Read and understand this owner's manual **BEFORE** using machine.

**TRAINED OPERATORS ONLY.** Untrained operators have a higher risk of being hurt or killed. Only allow trained/supervised people to use this machine. When machine is not being used, disconnect power, remove switch keys, or lock-out machine to prevent unauthorized use—especially around children. Make your workshop kid proof!

**DANGEROUS ENVIRONMENTS.** Do not use machinery in areas that are wet, cluttered, or have poor lighting. Operating machinery in these areas greatly increases the risk of accidents and injury.

**MENTAL ALERTNESS REQUIRED.** Full mental alertness is required for safe operation of machinery. Never operate under the influence of drugs or alcohol, when tired, or when distracted.

**ELECTRICAL EQUIPMENT INJURY RISKS.** You can be shocked, burned, or killed by touching live electrical components or improperly grounded machinery. To reduce this risk, only allow qualified service personnel to do electrical installation or repair work, and always disconnect power before accessing or exposing electrical equipment.

**DISCONNECT POWER FIRST.** Always disconnect machine from power supply **BEFORE** making adjustments, changing tooling, or servicing machine. This prevents an injury risk from unintended startup or contact with live electrical components.

**EYE PROTECTION.** Always wear ANSI-approved safety glasses or a face shield when operating or observing machinery to reduce the risk of eye injury or blindness from flying particles. Everyday eyeglasses are **NOT** approved safety glasses.



# WARNING

**WEARING PROPER APPAREL.** Do not wear clothing, apparel or jewelry that can become entangled in moving parts. Always tie back or cover long hair. Wear non-slip footwear to reduce risk of slipping and losing control or accidentally contacting cutting tool or moving parts.

**HAZARDOUS DUST.** Dust created by machinery operations may cause cancer, birth defects, or long-term respiratory damage. Be aware of dust hazards associated with each workpiece material. Always wear a NIOSH-approved respirator to reduce your risk.

**HEARING PROTECTION.** Always wear hearing protection when operating or observing loud machinery. Extended exposure to this noise without hearing protection can cause permanent hearing loss.

**REMOVE ADJUSTING TOOLS.** Tools left on machinery can become dangerous projectiles upon startup. Never leave chuck keys, wrenches, or any other tools on machine. Always verify removal before starting!

**USE CORRECT TOOL FOR THE JOB.** Only use this tool for its intended purpose—do not force it or an attachment to do a job for which it was not designed. Never make unapproved modifications—modifying tool or using it differently than intended may result in malfunction or mechanical failure that can lead to personal injury or death!

**AWKWARD POSITIONS.** Keep proper footing and balance at all times when operating machine. Do not overreach! Avoid awkward hand positions that make workpiece control difficult or increase the risk of accidental injury.

**CHILDREN & BYSTANDERS.** Keep children and bystanders at a safe distance from the work area. Stop using machine if they become a distraction.

**GUARDS & COVERS.** Guards and covers reduce accidental contact with moving parts or flying debris. Make sure they are properly installed, undamaged, and working correctly BEFORE operating machine.

**FORCING MACHINERY.** Do not force machine. It will do the job safer and better at the rate for which it was designed.

**NEVER STAND ON MACHINE.** Serious injury may occur if machine is tipped or if the cutting tool is unintentionally contacted.

**STABLE MACHINE.** Unexpected movement during operation greatly increases risk of injury or loss of control. Before starting, verify machine is stable and mobile base (if used) is locked.

**USE RECOMMENDED ACCESSORIES.** Consult this owner's manual or the manufacturer for recommended accessories. Using improper accessories will increase the risk of serious injury.

**UNATTENDED OPERATION.** To reduce the risk of accidental injury, turn machine **OFF** and ensure all moving parts completely stop before walking away. Never leave machine running while unattended.

**MAINTAIN WITH CARE.** Follow all maintenance instructions and lubrication schedules to keep machine in good working condition. A machine that is improperly maintained could malfunction, leading to serious personal injury or death.

**DAMAGED PARTS.** Regularly inspect machine for damaged, loose, or mis-adjusted parts—or any condition that could affect safe operation. Immediately repair/replace BEFORE operating machine. For your own safety, DO NOT operate machine with damaged parts!

**MAINTAIN POWER CORDS.** When disconnecting cord-connected machines from power, grab and pull the plug—NOT the cord. Pulling the cord may damage the wires inside. Do not handle cord/plug with wet hands. Avoid cord damage by keeping it away from heated surfaces, high traffic areas, harsh chemicals, and wet/damp locations.

**EXPERIENCING DIFFICULTIES.** If at any time you experience difficulties performing the intended operation, stop using the machine! Contact our Technical Support at (570) 546-9663.



# Additional Safety for Downdraft Tables

## **WARNING**

Long-term respiratory damage, cancer, or birth defects can occur from using this machine without proper use of a respirator. Explosions or fire can result if machine is used to capture incorrect materials, or dust/waste material is exposed to an ignition source. To reduce these risks, operator and bystanders **MUST** completely heed the warnings below.

**USE FOR INTENDED PURPOSE.** This dust collector is designed for collecting wood dust only. **DO NOT** use it to filter or collect liquids (especially flammables), metal shavings, lead paint, asbestos, or burning or smoking materials—including matches, cigarettes, and hot ashes. **DO NOT** use this machine to dissipate smoke or fumes.

**WEAR PROPER PPE.** Always wear a NIOSH-approved respirator and safety glasses when using this machine. Dust created while using machinery may cause cancer, birth defects, or long-term respiratory damage. Be aware of dust hazards associated with each workpiece material.

**REDUCE RISK OF EXPLOSIONS.** Suspended dust particles in conjunction with an ignition source may cause an explosion. Do not operate this machine in areas where explosion risks would be high if dust were dispersed into it. Areas of high risk include, but are not limited to, areas near pilot lights or open flames. **NEVER** use this downdraft table near paint fumes or within a paint spray booth.

**PROPERLY EMPTY DUST DRAWER.** Wear safety glasses and a NIOSH-approved respirator when emptying dust from dust drawer to reduce risk of exposure to fine particles. Empty dust into an approved container and dispose of properly.

**AVOID CONTACT WITH IMPELLERS.** **DO NOT** place hands, hair, clothing, or tools near impeller during operation to reduce risk of becoming entangled or getting cut.

**SAFE OPERATING LOCATION.** **DO NOT** place downdraft table where it can be exposed to rain or moisture—exposure to water creates a shock hazard and will reduce life of machine.

**UNDERSTAND RISK OF WOOD TOXICITY.** Research the dangers of the specific species of wood you are working with as dust from some woods are toxic and can make you sick, cause cancer, and lead to long-term respiratory problems.

**PROPERLY MAINTAIN MACHINE.** Keep machine in proper working condition to help ensure all guards and other components work as intended and function safely. Perform routine inspections and all necessary maintenance, as indicated in owner's manual. Never operate machine with damaged or worn parts that can break during operation.

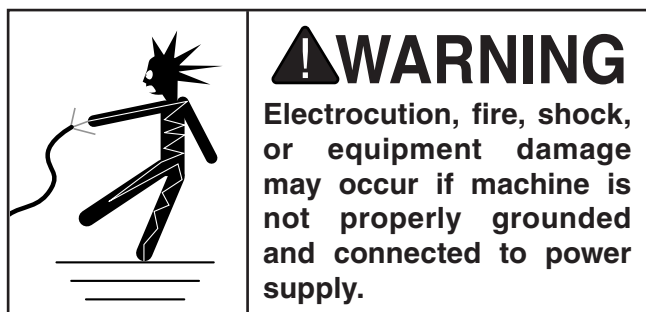
**COLLECTING LEAD AND ASBESTOS.** This machine will **NOT** protect against lead-paint dust or asbestos fibers. These materials must be collected with special equipment because of the high hazard to human health. **DO NOT** attempt to collect these materials with this machine.



# SECTION 2: POWER SUPPLY

## Availability

Before installing the machine, consider the availability and proximity of the required power supply circuit. If an existing circuit does not meet the requirements for this machine, a new circuit must be installed. To minimize the risk of electrocution, fire, or equipment damage, installation work and electrical wiring must be done by an electrician or qualified service personnel in accordance with all applicable codes and standards.



## Full-Load Current Rating

The full-load current rating is the amperage a machine draws at 100% of the rated output power. On machines with multiple motors, this is the amperage drawn by the largest motor or sum of all motors and electrical devices that might operate at one time during normal operations.

**H2935 Full-Load Current at 120V..... 7.5 Amps**

**H2936 Full-Load Current at 120V..... 8.5 Amps**

The full-load current is not the maximum amount of amps that the machine will draw. If the machine is overloaded, it will draw additional amps beyond the full-load rating.

If the machine is overloaded for a sufficient length of time, damage, overheating, or fire may result—especially if connected to an undersized circuit. To reduce the risk of these hazards, avoid overloading the machine during operation and make sure it is connected to a power supply circuit that meets the specified circuit requirements.

## **! WARNING**

**Serious injury could occur if you connect machine to power before completing setup process. DO NOT connect to power until instructed later in this manual.**

## 120V Circuit Requirements

This machine is prewired to operate on a power supply circuit that has a verified ground and meets the following requirements:

**Nominal Voltage ..... 110V, 115V, 120V**  
**Cycle ..... 60 Hz**  
**Phase ..... Single-Phase**  
**Power Supply Circuit ..... 15 Amps**

A power supply circuit includes all electrical equipment between the breaker box or fuse panel in the building and the machine. The power supply circuit used for this machine must be sized to safely handle the full-load current drawn from the machine for an extended period of time. (If this machine is connected to a circuit protected by fuses, use a time delay fuse marked D.)

## **! CAUTION**

**For your own safety and protection of property, consult an electrician if you are unsure about wiring practices or electrical codes in your area.**

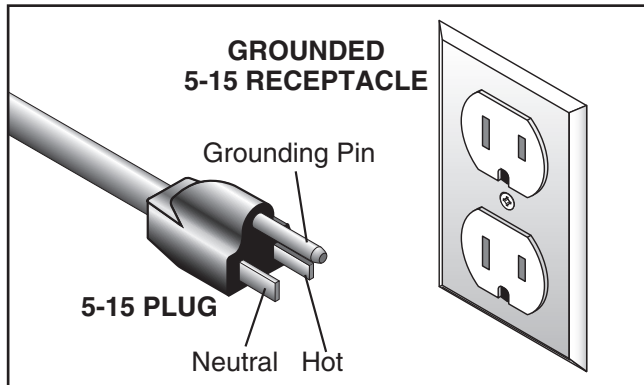
**Note:** *Circuit requirements in this manual apply to a dedicated circuit—where only one machine will be running on the circuit at a time. If machine will be connected to a shared circuit where multiple machines may be running at the same time, consult an electrician or qualified service personnel to ensure circuit is properly sized for safe operation.*



## Grounding & Plug Requirements

This machine **MUST** be grounded. In the event of certain malfunctions or breakdowns, grounding reduces the risk of electric shock by providing a path of least resistance for electric current.

This machine is equipped with a power cord that has an equipment-grounding wire and a grounding plug. Only insert plug into a matching receptacle (outlet) that is properly installed and grounded in accordance with all local codes and ordinances. **DO NOT** modify the provided plug!



**Figure 1.** Typical 5-15 plug and receptacle.

**⚠ CAUTION**

**SHOCK HAZARD!**

**Two-prong outlets do not meet the grounding requirements for this machine. Do not modify or use an adapter on the plug provided—if it will not fit the outlet, have a qualified electrician install the proper outlet with a verified ground.**

Improper connection of the equipment-grounding wire can result in a risk of electric shock. The wire with green insulation (with or without yellow stripes) is the equipment-grounding wire. If repair or replacement of the power cord or plug is necessary, do not connect the equipment-grounding wire to a live (current carrying) terminal.

Check with a qualified electrician or service personnel if you do not understand these grounding requirements, or if you are in doubt about whether the tool is properly grounded. If you ever notice that a cord or plug is damaged or worn, disconnect it from power, and immediately replace it with a new one.

## Extension Cords

We do not recommend using an extension cord with this machine. If you must use an extension cord, only use it if absolutely necessary and only on a temporary basis.

Extension cords cause voltage drop, which can damage electrical components and shorten motor life. Voltage drop increases as the extension cord size gets longer and the gauge size gets smaller (higher gauge numbers indicate smaller sizes).

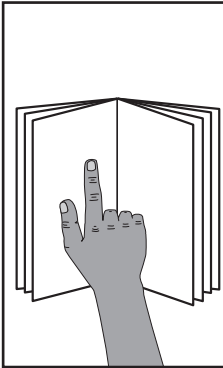
Any extension cord used with this machine must be in good condition and contain a ground wire and matching plug/receptacle. Additionally, it must meet the following size requirements:

**Minimum Gauge Size ..... 14 AWG**  
**Maximum Length (Shorter is Better).....50 ft.**



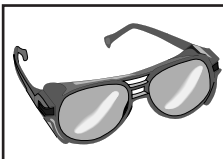


# SECTION 3: SETUP



## **!WARNING**

This machine presents serious injury hazards to untrained users. Read through this entire manual to become familiar with the controls and operations before starting the machine!



## **!WARNING**

Wear safety glasses during the entire setup process!



## **!WARNING**

### **HEAVY LIFT!**

Straining or crushing injury may occur from improperly lifting machine or some of its parts. To reduce this risk, get help from other people and use a forklift (or other lifting equipment) rated for weight of this machine.

## Needed for Setup

The following items are needed, but not included, for the setup/assembly of this machine.

Description	Qty
• Forklift.....	1
• Assistant for Lifting Help .....	1
• Safety Glasses (for each person).....	1
• Open-End Wrenches 1/2", 9/16".....	1 Ea.
• Phillips Screwdriver #2 .....	1
• Wrench or Socket 3/8" .....	1

## Unpacking

This machine was carefully packaged for safe transport. When unpacking, separate all enclosed items from packaging materials and inspect them for shipping damage. ***If items are damaged, please call us immediately at (570) 546-9663.***

**IMPORTANT:** Save all packaging materials until you are completely satisfied with the machine and have resolved any issues between Grizzly or the shipping agent. ***You MUST have the original packaging to file a freight claim. It is also extremely helpful if you need to return your machine later.***



# Inventory

The following is a list of items shipped with your machine. Before beginning setup, lay these items out and inventory them.

If any non-proprietary parts are missing (e.g. a nut or a washer), we will gladly replace them; or for the sake of expediency, replacements can be obtained at your local hardware store.

## NOTICE

If you cannot find an item on this list, carefully check around/inside the machine and packaging materials. Often, these items get lost in packaging materials while unpacking or they are pre-installed at the factory.

Box 1 (Figures 2–3)	Qty
A. Downdraft Sanding Table Cabinet .....	1
B. Hanger .....	1
C. Center Panel.....	1
D. Filter 16" x 20" x 2" (H2935).....	1
Filter 16" x 25" x 2" (H2936).....	1
E. Filter 16" x 20" x 1" (H2935).....	1
Filter 16" x 25" x 1" (H2936) .....	1
F. Downdraft Plates (H2935) .....	4
Downdraft Plates (H2936) .....	5
G. Right Panel.....	1
H. Left Panel .....	1
I. Hardware (Not Shown)	
—Foot Pad Screws (Cabinet Base).....	4
—Hex Nuts $\frac{3}{8}$ "-16 (Cabinet Base).....	4
—Pins (Panels).....	7
—Handle (Outlet Plate) .....	1
—Hex Nut $\frac{5}{16}$ "-18 (Power Cord Hanger) ....	1



Figure 2. Downdraft cabinet.

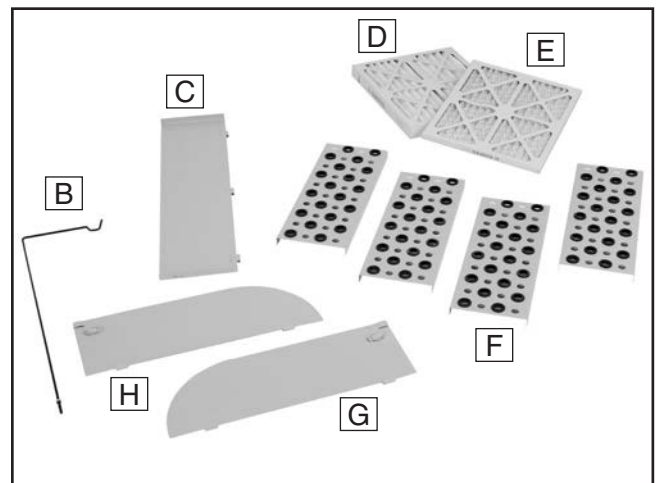


Figure 3. Inventory.





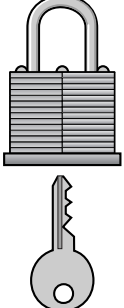
# Site Considerations

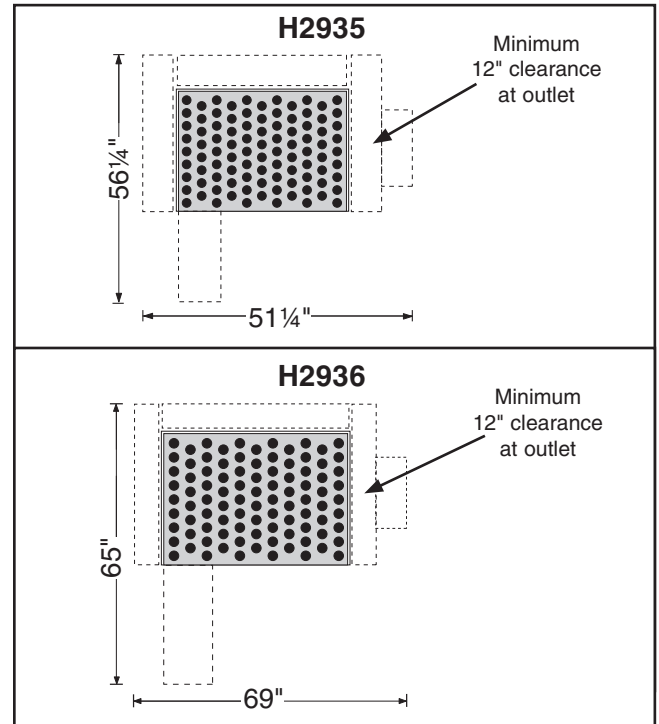
## Floor Load

Refer to the **Machine Data Sheet** for the weight and footprint specifications of your machine. Some residential floors may require additional reinforcement to support both the machine and operator.

## Working Clearances

Consider existing and anticipated needs, size of material to be processed through each machine, and space for auxiliary stands, work tables or other machinery when establishing a location for your new machine. See **Figure 4** for the minimum working clearances.

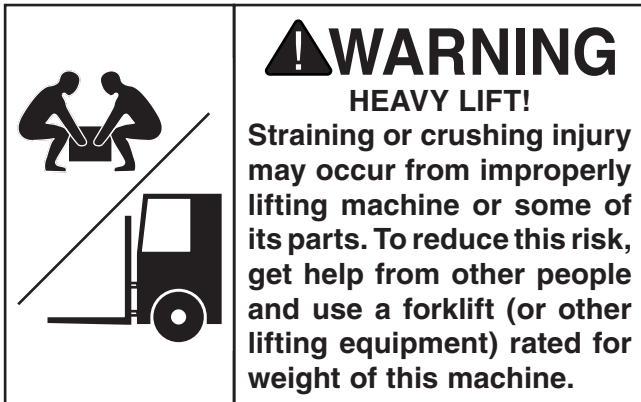
	<p><b>⚠ CAUTION</b></p> <p>Children and visitors may be seriously injured if unsupervised around this machine. Lock entrances to the shop or disable start switch or power connection to prevent unsupervised use.</p>
--	--



**Figure 4.** Minimum working clearances.



# Lifting & Placing



Use a forklift to lift the machine to a suitable location, and with the help of several people, place the downdraft table into position on the floor.

## Assembly

The machine must be fully assembled before it can be operated. Before beginning the assembly process, refer to **Needed for Setup** and gather all listed items. To ensure the assembly process goes smoothly, first clean any parts that are covered or coated in heavy-duty rust preventative (if applicable).

### To assemble machine:

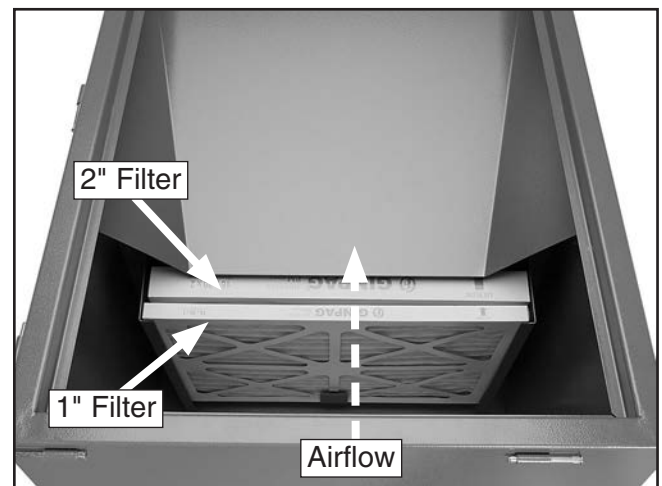
1. With assistant's help, lay back of downdraft table cabinet flat on the floor.
2. Thread (4)  $\frac{3}{8}$ "-16 hex nuts onto foot pad screws, then install foot pads in holes in bottom of downdraft table (see **Figure 5**).



**Figure 5.** Installing foot pads.

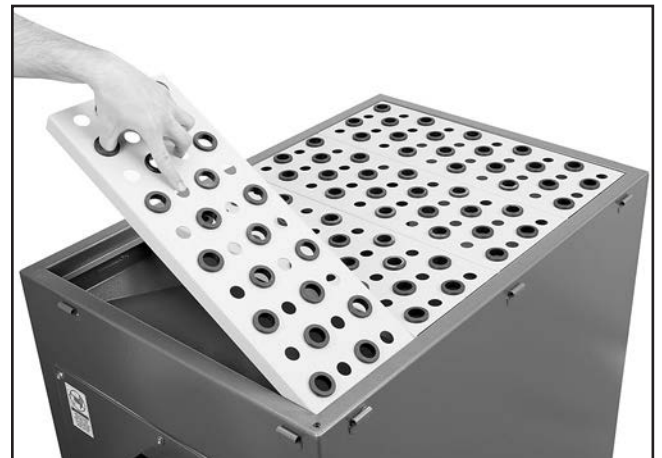
3. With assistant's help, return downdraft table to upright position so it rests on foot pads.
4. Make sure all four footpads touch the floor evenly. Adjust individual footpads as necessary and secure hex nuts against bottom of cabinet.
5. Install 2" thick filter in filter bay inside downdraft table cabinet, as shown in **Figure 6**, then install 1" thick filter in front of it.

**Note:** Be sure to remove plastic wrapping from filters before installing. Also, to ensure filters function correctly, orient filters so metal webbing points toward impeller.



**Figure 6.** Filters installed in filter bay.

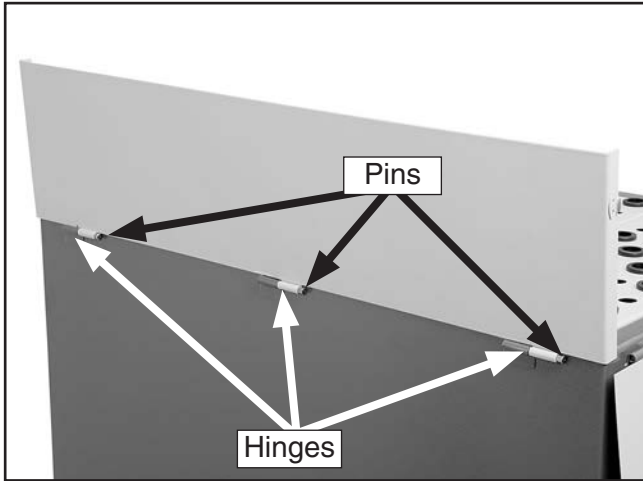
6. Install downdraft plates, as shown in **Figure 7**.



**Figure 7.** Installing downdraft plates.

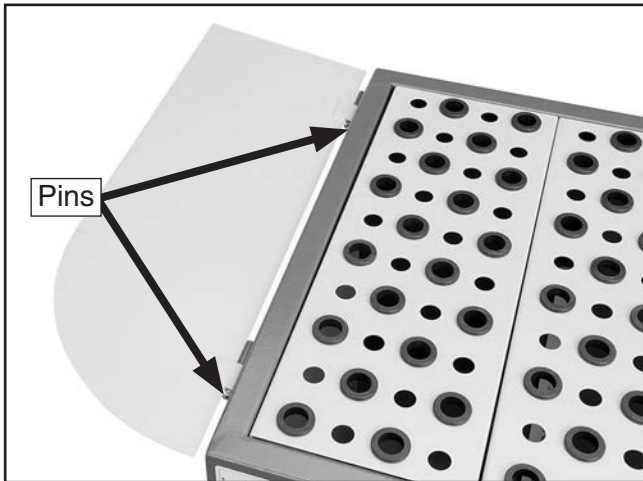
7. Align center panel and rear sanding table hinges, then secure with three pins, as shown in **Figure 8**.



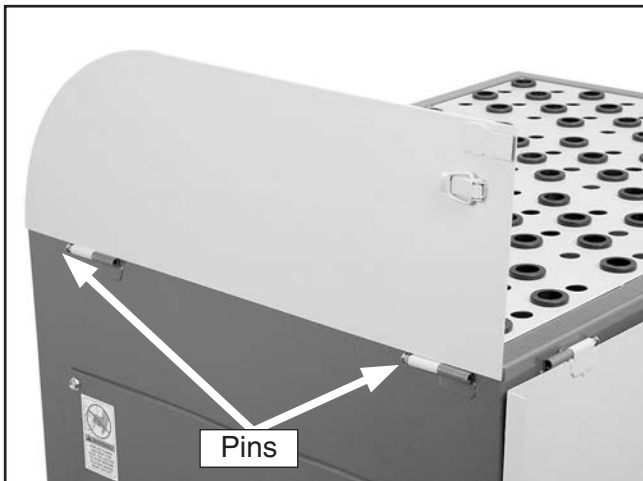


**Figure 8.** Center panel installed.

8. Secure right and left panels with remaining pins, as shown in **Figures 9–10**.

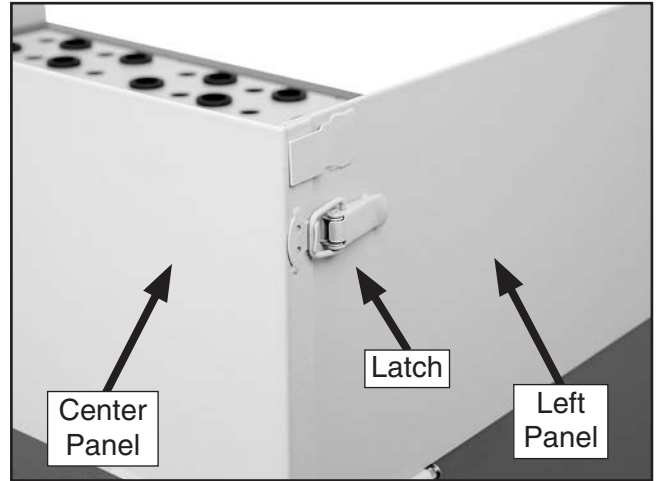


**Figure 9.** Left panel installed.



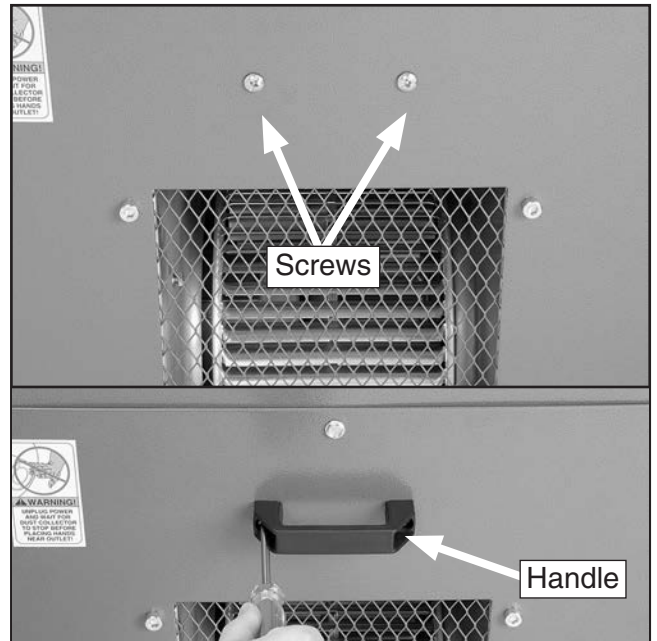
**Figure 10.** Right panel installed.

9. With side panels in upright position, slide center panel (see **Figure 11**) into side panel brackets and secure with latch.



**Figure 11.** Panels secured with latches (one shown).

10. Remove (2) screws (see **Figure 12, top**) on outlet plate and use these to mount the handle to the plate (**Figure 12, bottom**).



**Figure 12.** Installing outlet plate handle.

11. Thread hex nut onto bottom of power cord hanger, then install hanger in hole in right-hand side of cabinet.

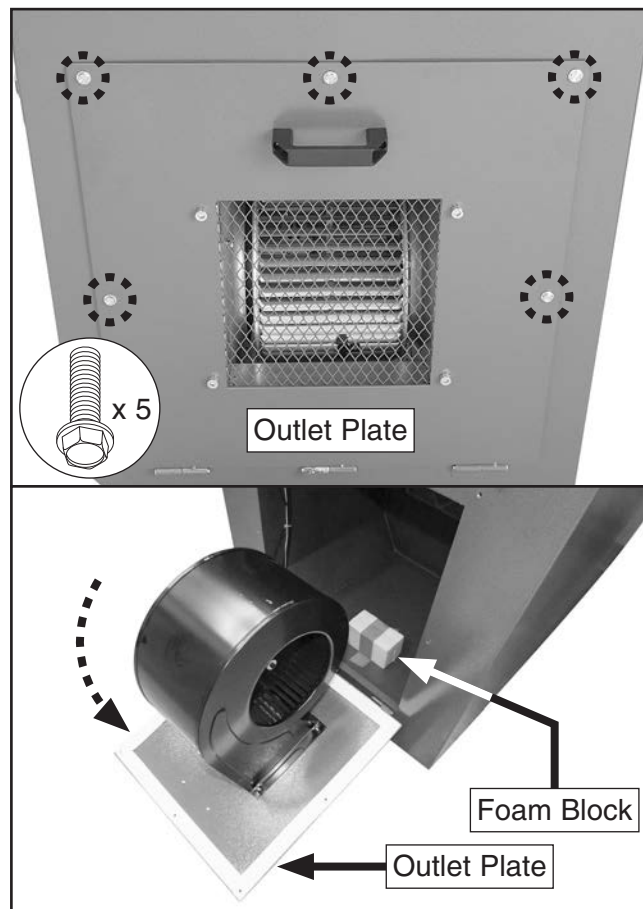


12. Remove (5) flange bolts from outlet plate, then open outlet plate (see **Figure 13**).

**Note:** *Outlet plate is hinged and will swing out when flange bolts are removed.*

13. Remove all packing material and foam blocks located in cabinet interior (see **Figure 13**).

14. Close outlet plate and install (5) flange bolts removed in **Step 12**.



**Figure 13.** Location of packing material inside machine cabinet.



# Test Run

Once assembly is complete, test run the machine to ensure it is properly connected to power and safety components are functioning correctly.

If you find an unusual problem during the test run, immediately stop the machine, disconnect it from power, and fix the problem **BEFORE** operating the machine again. The **Troubleshooting** table in the **SERVICE** section of this manual can help.

The Test Run consists of verifying the following:  
1) The motor powers up and runs correctly, and  
2) the switch disabling key disables the switch properly.

## **!WARNING**

**Serious injury or death can result from using this machine BEFORE understanding its controls and related safety information. DO NOT operate, or allow others to operate, machine until the information is understood.**

## **!WARNING**

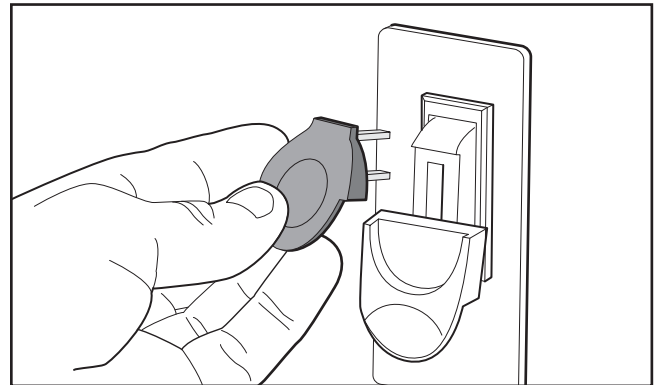
**DO NOT start machine until all preceding setup instructions have been performed. Operating an improperly set up machine may result in malfunction or unexpected results that can lead to serious injury, death, or machine/property damage.**

### To test run machine:

1. Clear all setup tools away from machine.
2. Connect machine to power supply.
3. Turn machine **ON**, verify motor operation, and then turn machine **OFF**.

The motor should run smoothly and without unusual problems or noises.

4. Remove switch disabling key, as shown in **Figure 14**.



**Figure 14.** Removing switch key from paddle switch.

5. Try to start machine with paddle switch. The machine should not start.
  - If the machine *does not* start, the switch disabling feature is working correctly.
  - If the machine *does start*, immediately stop the machine. The switch disabling feature is not working correctly. This safety feature must work properly before proceeding with regular operations. Call Tech Support for help.





# SECTION 4: OPERATIONS



**!WARNING**  
To reduce your risk of serious injury, read this entire manual **BEFORE** using machine.

**!WARNING**  
To reduce risk of eye injury from flying chips or lung damage from breathing dust, always wear safety glasses and a respirator when operating this machine.



**NOTICE**  
If you are not experienced with this type of machine, WE STRONGLY RECOMMEND that you seek additional training outside of this manual. Read books/magazines or get formal training before beginning any projects. Regardless of the content in this section, Grizzly Industrial will not be held liable for accidents caused by lack of training.

## Operation

This downdraft table draws dust from the work table into a two-stage filter system, virtually eliminating dust from the air. The side panels can be latched in place or folded down to make room for larger workpieces. Dust is collected in a drawer at the front of the machine and can be easily removed for cleaning.

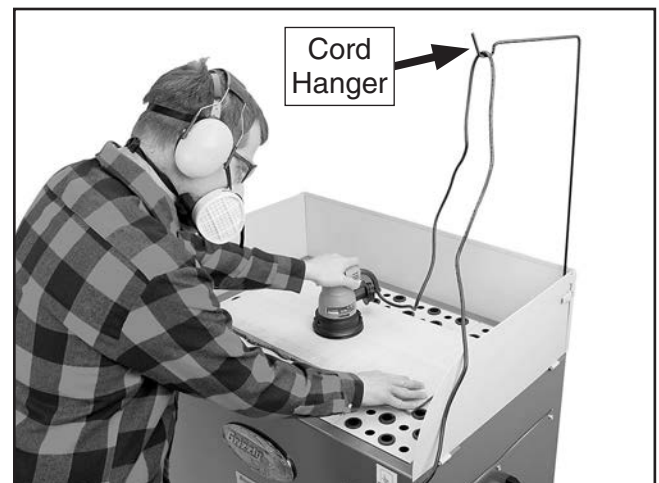
**IMPORTANT:** Two portable electric sanders can be plugged in and operated simultaneously, but the combined amp draw cannot exceed the following:

H2935 Maximum Amp Draw ..... 7 Amps  
H2936 Maximum Amp Draw ..... 6 Amps

To use downdraft table:

1. Place panels in upright position and latch in place; or fold panels down when sanding larger workpieces that extend beyond the table.
2. Plug a portable sander into one of two outlets on front of downdraft table.
3. Place workpiece on table, turn downdraft table **ON**, and perform operation (see **Figure 15**).

**Tip:** Use power cord hanger (see **Figure 15**) to keep long cords out of the way.



**Figure 15.** Typical sanding operation setup.

4. Turn downdraft table **OFF** when finished.

## Resetting Circuit Breaker

The machine is equipped with a reset button (see **Page 3**) that allows the motor to be restarted after the overload protection has tripped. To reset, place the ON/OFF switch in the OFF position, wait a few minutes for the motor to cool, then press the reset button. If the button does not stay depressed, allow the system to cool longer, then try again.

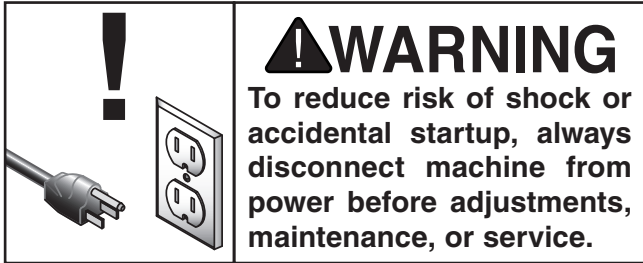




# SECTION 5: MAINTENANCE

---

---



## Schedule

---

---

For optimum performance from this machine, this maintenance schedule must be strictly followed.

### Ongoing

To minimize your risk of injury and maintain proper machine operation, shut down the machine immediately if you ever observe any of the items below, and fix the problem before continuing operations:

- Loose mounting bolts.
- Worn or damaged wires.
- Any other unsafe condition.

### Weekly Maintenance

- Check filters.
- Clean dust drawer.

### Monthly Check

- Clean/vacuum dust buildup from inside cabinet and off motor.

## Cleaning

---

---

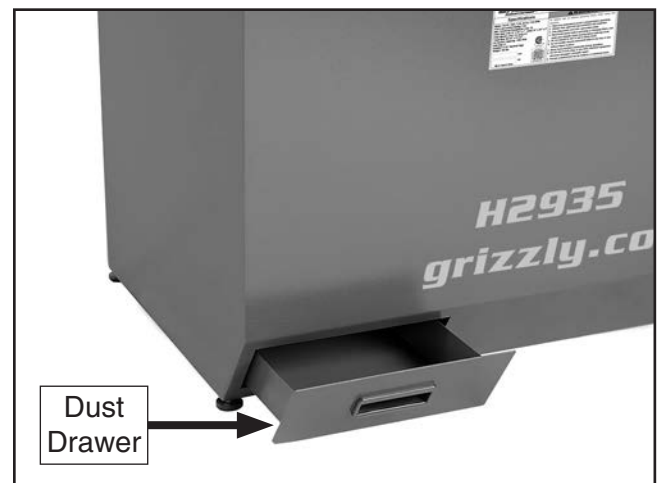
Cleaning the Model H2935/H2936 is relatively easy. Vacuum excess dust and wipe off the remaining dust with a dry cloth.

## Emptying Dust Drawer

---

---

Frequently monitor and empty the dust drawer of accumulated sawdust (see **Figure 16**).

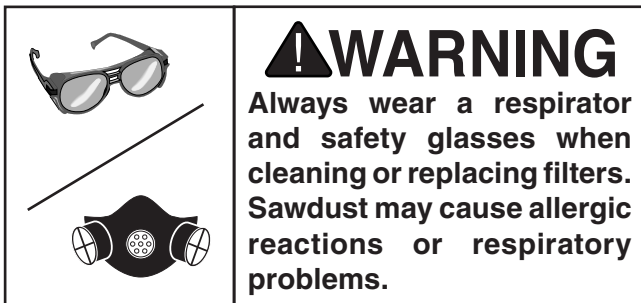
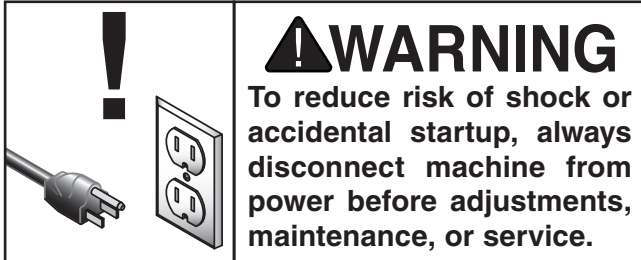


**Figure 16.** Location of dust drawer.



# Servicing Filters

The filters may need to be serviced or replaced if suction is noticeably reduced. The amount of use has a direct bearing on how often you must service or change the 1" prefilter and 2" filter.



## To service filters:

1. DISCONNECT MACHINE FROM POWER!
2. Remove two downdraft plates on right-hand side of table, then remove filters.
3. Gently shake filters inside a garbage can.
4. Visually inspect filters to determine if they need to be replaced.

**Note:** During regular use, filters can be cleaned several times before replacement becomes necessary.

5. Re-install or replace filters, and re-install downdraft plates.

# Accessories

## **! WARNING**

Installing unapproved accessories may cause machine to malfunction, resulting in serious personal injury or machine damage. To reduce this risk, only install accessories recommended for this machine by Grizzly.

## **NOTICE**

Refer to our website or latest catalog for additional recommended accessories.

H2452— 16" x 20" x 1" Prefilter for H2935  
H4961—16" x 25" x 1" Prefilter for H2936

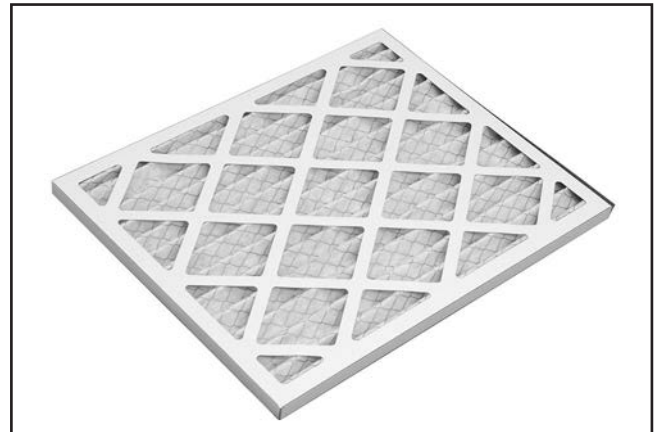


Figure 17. 1" replacement filter.

H5838—16" x 20" x 2" Filter for H2935  
H4938—16" x 25" x 2" Filter for H2936

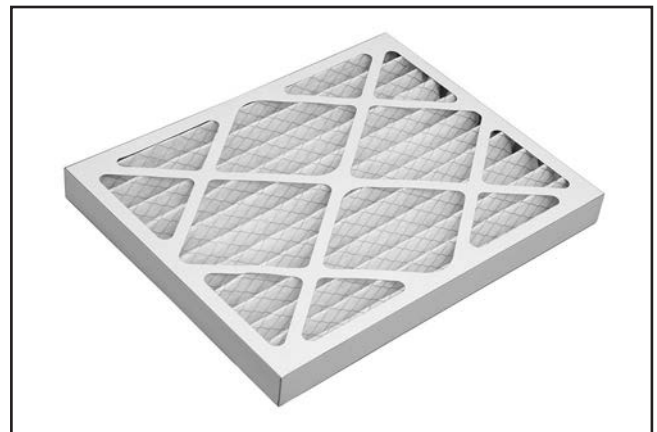


Figure 18. 2" replacement filter.

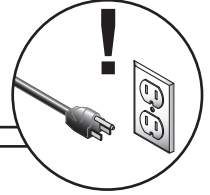




# SECTION 6: SERVICE

Review the troubleshooting procedures in this section if a problem develops with your machine. If you need replacement parts or additional help with a procedure, call our Technical Support. **Note:** *Please gather the serial number and manufacture date of your machine before calling.*

## Troubleshooting



### Motor & Electrical

Symptom	Possible Cause	Possible Solution
Machine does not start, or power supply breaker immediately trips after startup.	<ol style="list-style-type: none"> <li>1. Switch disabling key removed.</li> <li>2. Amp draw of sanding tools too high. Machine circuit breaker tripped or at fault.</li> <li>3. Incorrect power supply voltage or circuit size.</li> <li>4. Power supply circuit breaker tripped or fuse blown.</li> <li>5. Wiring broken, disconnected, or corroded.</li> <li>6. ON/OFF switch at fault.</li> <li>7. Motor or motor bearings at fault.</li> </ol>	<ol style="list-style-type: none"> <li>1. Install switch disabling key.</li> <li>2. Reset circuit breaker on switch. Use sanding tools with less amperage draw.</li> <li>3. Ensure correct power supply voltage and circuit size.</li> <li>4. Ensure circuit is free of shorts. Reset circuit breaker or replace fuse.</li> <li>5. Fix broken wires or disconnected/corroded connections.</li> <li>6. Replace switch.</li> <li>7. Replace motor.</li> </ol>
Machine stalls or is underpowered.	<ol style="list-style-type: none"> <li>1. Motor overheated, tripping machine circuit breaker.</li> <li>2. Run capacitor at fault.</li> <li>3. Motor or motor bearings at fault.</li> </ol>	<ol style="list-style-type: none"> <li>1. Clean motor, let cool, and reduce workload. Reset breaker.</li> <li>2. Test/repair/replace.</li> <li>3. Replace motor.</li> </ol>
Machine has vibration or noisy operation.	<ol style="list-style-type: none"> <li>1. Motor or component loose.</li> <li>2. Feet not adjusted properly.</li> <li>3. Motor bearings at fault.</li> </ol>	<ol style="list-style-type: none"> <li>1. Replace damaged or missing bolts/nuts or tighten if loose.</li> <li>2. Adjust stand feet to stabilize machine.</li> <li>3. Test by rotating shaft; rotational grinding/loose shaft requires bearing replacement.</li> </ol>
Hand tools stall or are underpowered.	<ol style="list-style-type: none"> <li>1. Plug/receptacle at fault.</li> </ol>	<ol style="list-style-type: none"> <li>1. Test for good contacts; correct the wiring.</li> </ol>

### Operation

Symptom	Possible Cause	Possible Solution
Downdraft table does not adequately collect dust; poor performance.	<ol style="list-style-type: none"> <li>1. Dust collection drawer is full.</li> <li>2. Filter is dirty.</li> </ol>	<ol style="list-style-type: none"> <li>1. Empty collection drawer (<b>Page 21</b>).</li> <li>2. Knock dust off filter. If this has no effect, replace with new filter unit.</li> </ol>



# SECTION 7: WIRING

These pages are current at the time of printing. However, in the spirit of improvement, we may make changes to the electrical systems of future machines. Compare the manufacture date of your machine to the one stated in this manual, and study this section carefully.

If there are differences between your machine and what is shown in this section, call Technical Support at (570) 546-9663 for assistance BEFORE making any changes to the wiring on your machine. An updated wiring diagram may be available. **Note:** *Please gather the serial number and manufacture date of your machine before calling. This information can be found on the main machine label.*

## WARNING

### Wiring Safety Instructions

**SHOCK HAZARD.** Working on wiring that is connected to a power source is extremely dangerous. Touching electrified parts will result in personal injury including but not limited to severe burns, electrocution, or death. Disconnect the power from the machine before servicing electrical components!

**MODIFICATIONS.** Modifying the wiring beyond what is shown in the diagram may lead to unpredictable results, including serious injury or fire. This includes the installation of unapproved after-market parts.

**WIRE CONNECTIONS.** All connections must be tight to prevent wires from loosening during machine operation. Double-check all wires disconnected or connected during any wiring task to ensure tight connections.

**CIRCUIT REQUIREMENTS.** You MUST follow the requirements at the beginning of this manual when connecting your machine to a power source.

**WIRE/COMPONENT DAMAGE.** Damaged wires or components increase the risk of serious personal injury, fire, or machine damage. If you notice that any wires or components are damaged while performing a wiring task, replace those wires or components.

**MOTOR WIRING.** The motor wiring shown in these diagrams is current at the time of printing but may not match your machine. If you find this to be the case, use the wiring diagram inside the motor junction box.















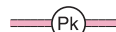
**CAPACITORS/INVERTERS.** Some capacitors and power inverters store an electrical charge for up to 10 minutes after being disconnected from the power source. To reduce the risk of being shocked, wait at least this long before working on capacitors.

**EXPERIENCING DIFFICULTIES.** If you are experiencing difficulties understanding the information included in this section, contact our Technical Support at (570) 546-9663.

#### NOTICE

The photos and diagrams included in this section are best viewed in color. You can view these pages in color at [www.grizzly.com](http://www.grizzly.com).

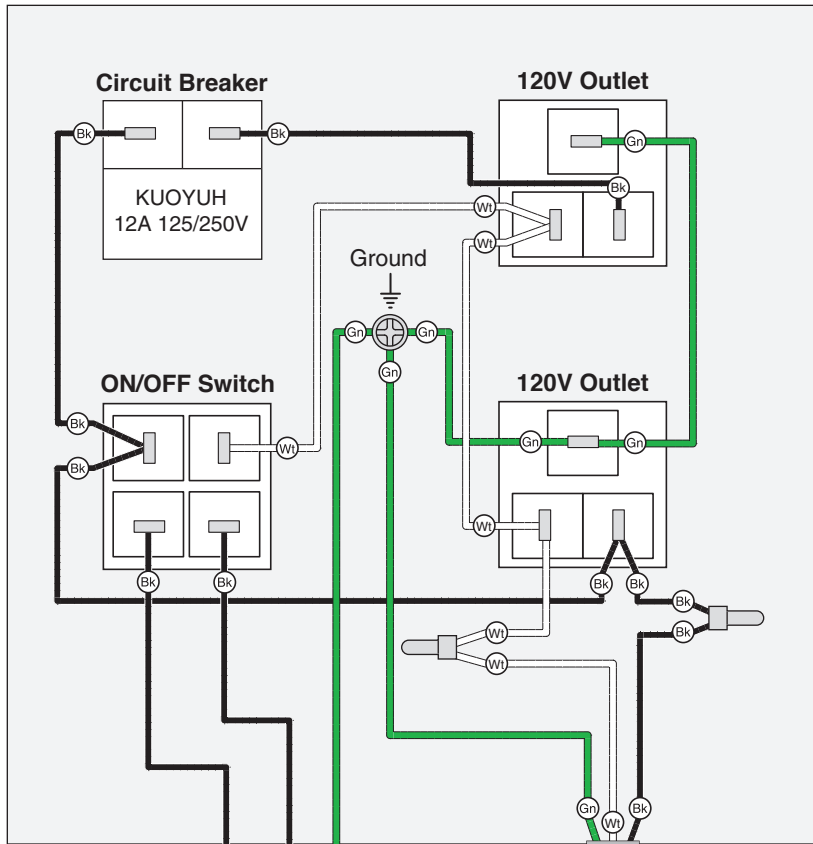
#### COLOR KEY

BLACK 	BLUE 	YELLOW 	LIGHT BLUE 
WHITE 	BROWN 	YELLOW GREEN 	BLUE WHITE 
GREEN 	GRAY 	PURPLE 	TURQUOISE 
RED 	ORANGE 	PINK 	

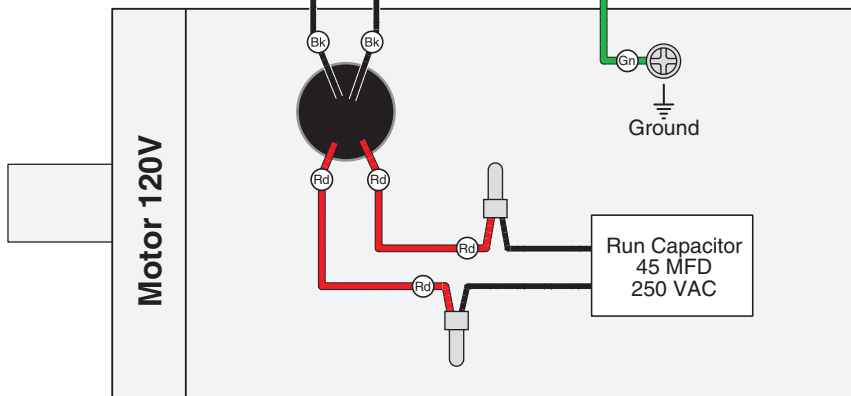
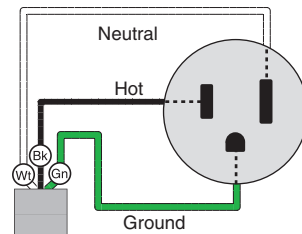


# H2935 Wiring Diagram

## Control Panel

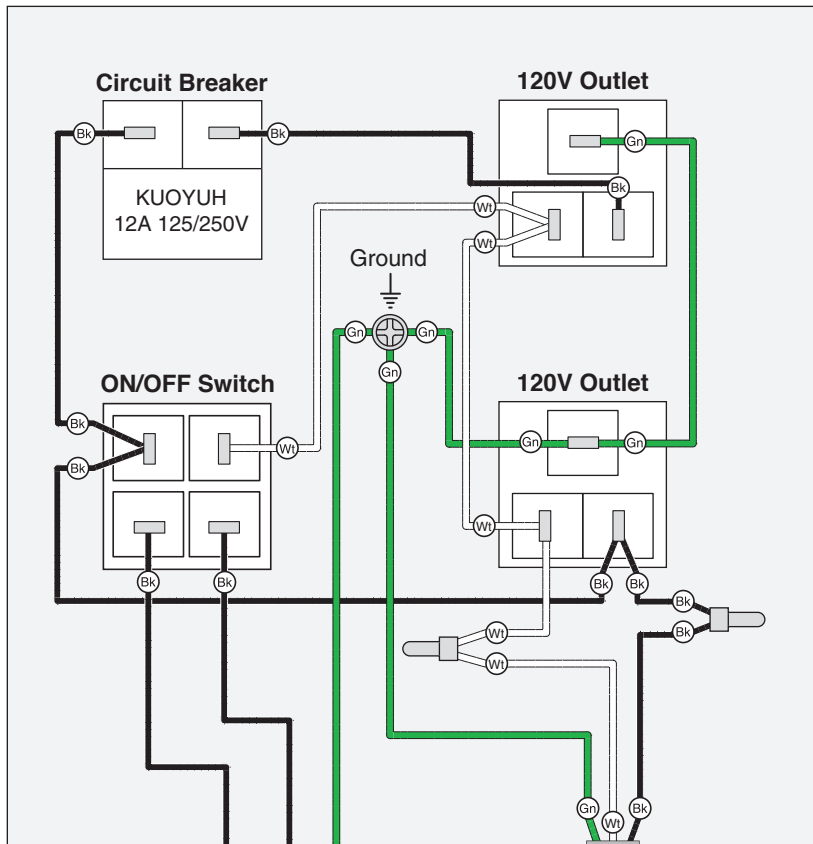


  
**120 VAC**  
5-15 Plug

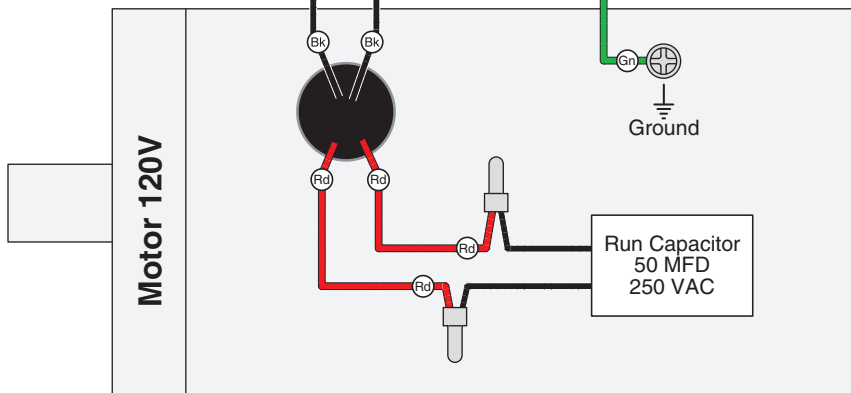
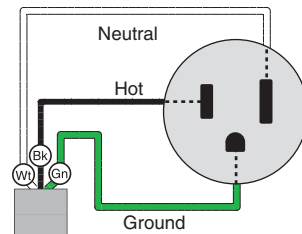


# H2936 Wiring Diagram

## Control Panel



  
**120 VAC**  
5-15 Plug



# H2935/H2936 Electrical Components

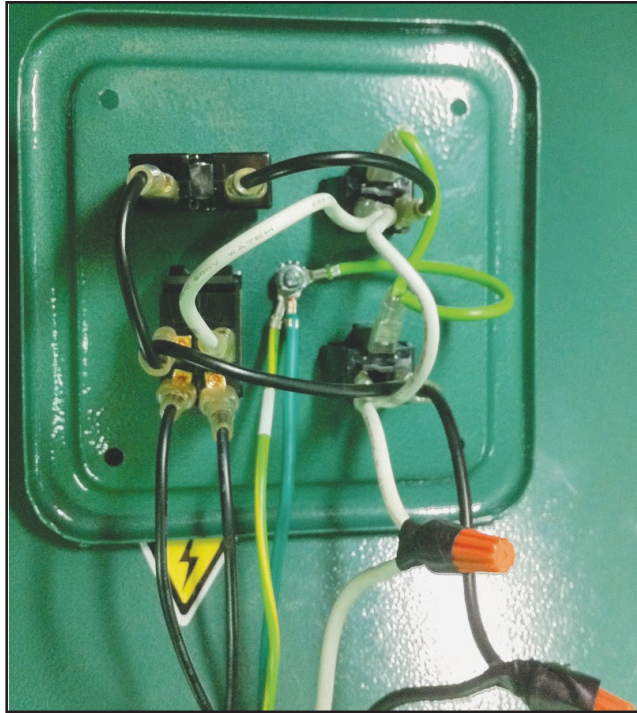


Figure 19. Switch wiring.

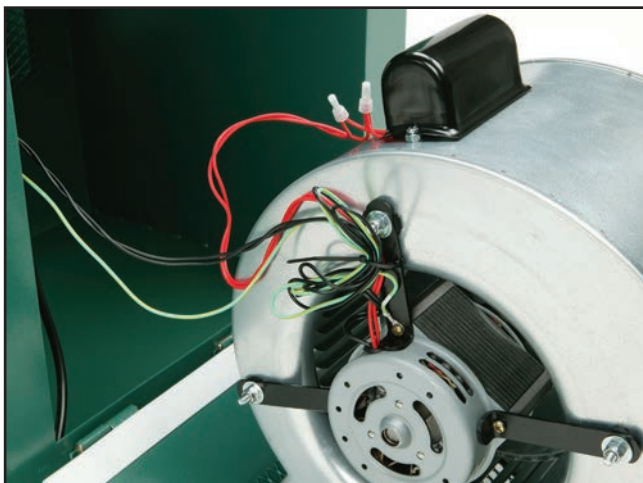


Figure 20. Motor wiring.

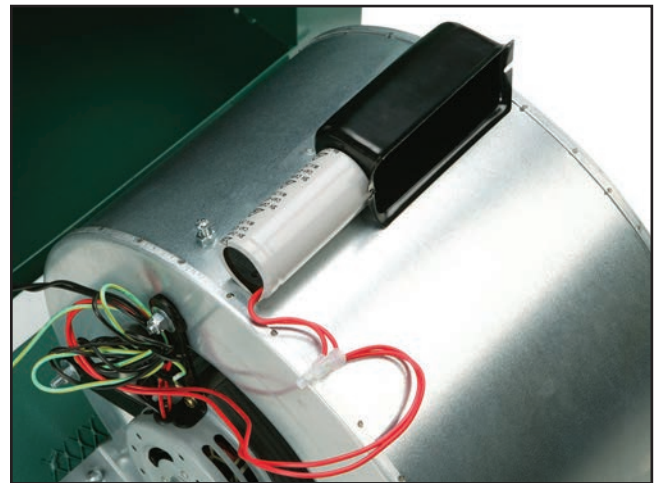


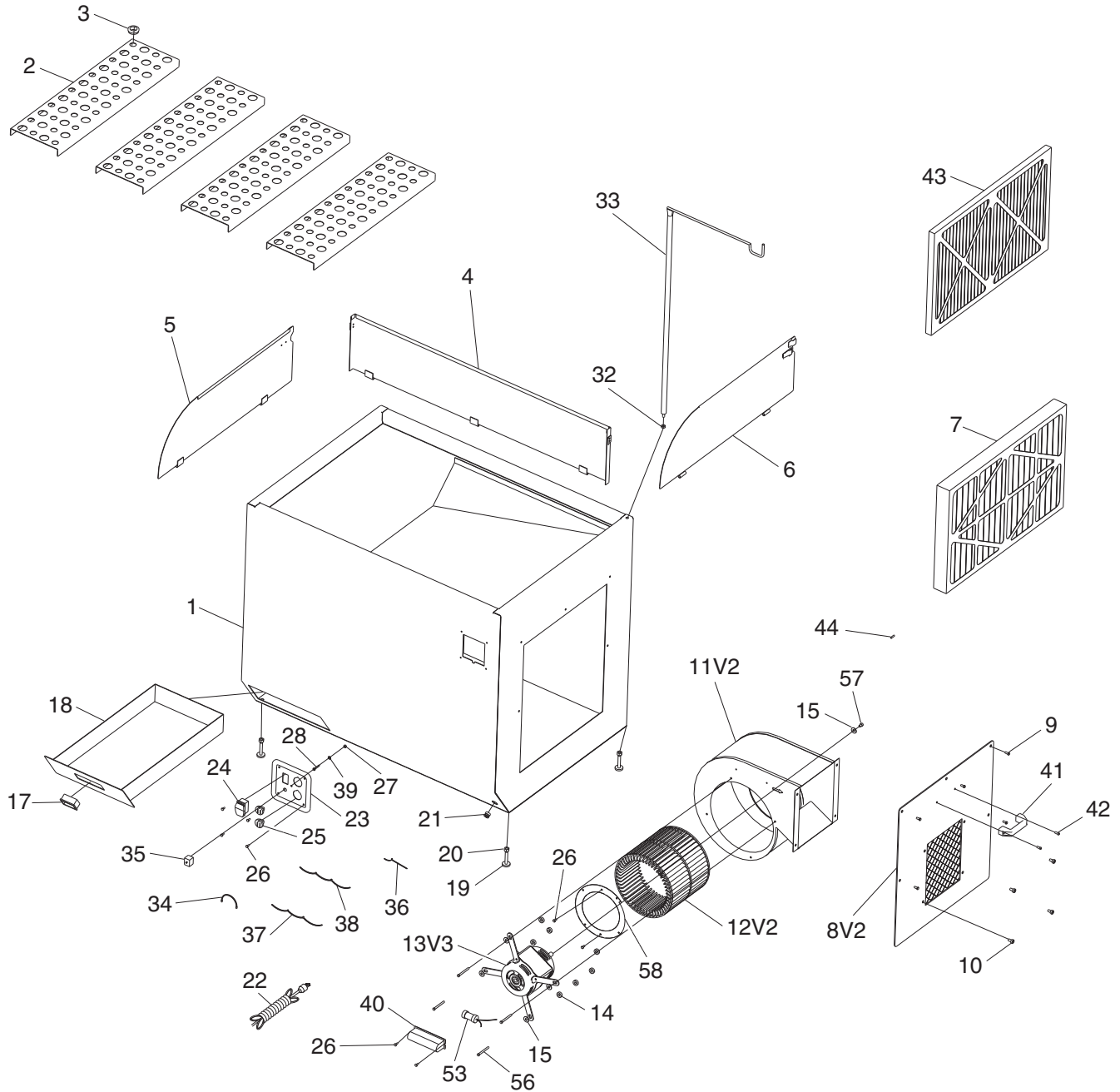
Figure 21. Run capacitor wiring.



# SECTION 8: PARTS

We do our best to stock replacement parts when possible, but we cannot guarantee that all parts shown are available for purchase. Call (800) 523-4777 or visit [www.grizzly.com/parts](http://www.grizzly.com/parts) to check for availability.

## H2935 Main



# H2935 Main Parts List

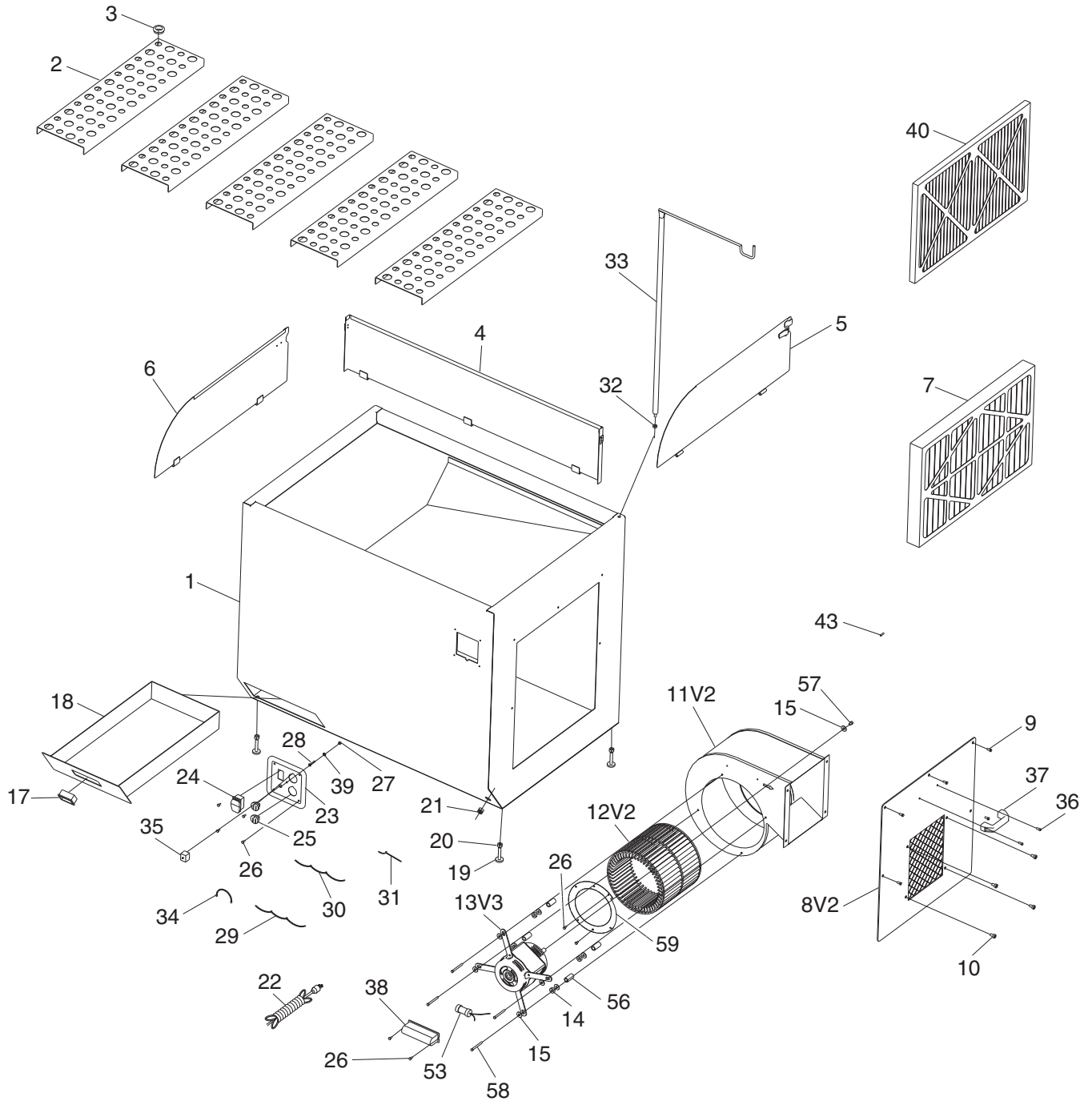
REF	PART #	DESCRIPTION
1	PH2935001	MAIN BASE
2	PH2935002	DUST COLLECTING PLATE 25-3/8"
3	PH2935003	GROMMET 31 X 22MM
4	PH2935004	CENTER PANEL
5	PH2935005	LEFT PANEL
6	PH2935006	RIGHT PANEL
7	PH2935007	FILTER 16" X 20" X 2
8V2	PH2935008V2	OUTLET PLATE V2.04.09
9	PH2935009	FLANGE BOLT 1/4-20 X 1/2
10	PH2935010	CAP SCREW 1/4-20 X 1/2
11V2	PH2935011V2	FAN HOUSING V2.04.09
12V2	PH2935012V2	IMPELLER V2.04.09
13V3	PH2935013V3	MOTOR 1/3HP 120V 1-PH V3.06.16
14	PH2935014	VIBRATION DAMPING MOTOR MOUNT
15	PH2935015	FLAT WASHER 1/4
17	PH2935017	HANDLE
18	PH2935018	DRAWER
19	PH2935019	FOOT PAD SCREW 3/8-16 X 2
20	PH2935020	HEX NUT 3/8-16
21	PH2935021	STRAIN RELIEF
22	PH2935022	POWER CORD 14G 3W 96" 5-15P
23	PH2935023	SWITCH PLATE

REF	PART #	DESCRIPTION
24	PH2935024	PADDLE SWITCH 110/220V W/ KEY
25	PH2935025	RECEPTACLE 120V
26	PH2935026	PHLP HD SCR 10-24 X 3/4
27	PH2935027	HEX NUT 10-24
28	PH2935028	PHLP HD SCR 10-24 X 1
32	PH2935032	HEX NUT 5/16-18
33	PH2935033	HANGER
34	PH2935034	SHORT CONNECTOR
35	PH2935035	CIRCUIT BREAKER KUOYUH 12A 125/250V
36	PH2935036	GROUNDING CONNECTOR
37	PH2935037	POWER CORD CONNECTOR W
38	PH2935038	POWER CORD CONNECTOR B
39	PH2935039	EXT TOOTH WASHER #10
40	PH2935040	CAPACITOR COVER
41	PH2935041	HANDLE
42	PH2935042	PHLP HD SCR 1/4-20 x 5/8
43	PH2935043	FILTER 16" X 20" X 1"
44	PH2935044	PANEL PIN
53	PH2935053	R CAPACITOR 45M 250V 2 X 2-1/2
56	PH2935056	HEX BOLT 1/4-20 X 1
57	PH2935057	CAP SCREW M6-1 X 8
58	PH2935058	INLET COVER





# H2936 Main





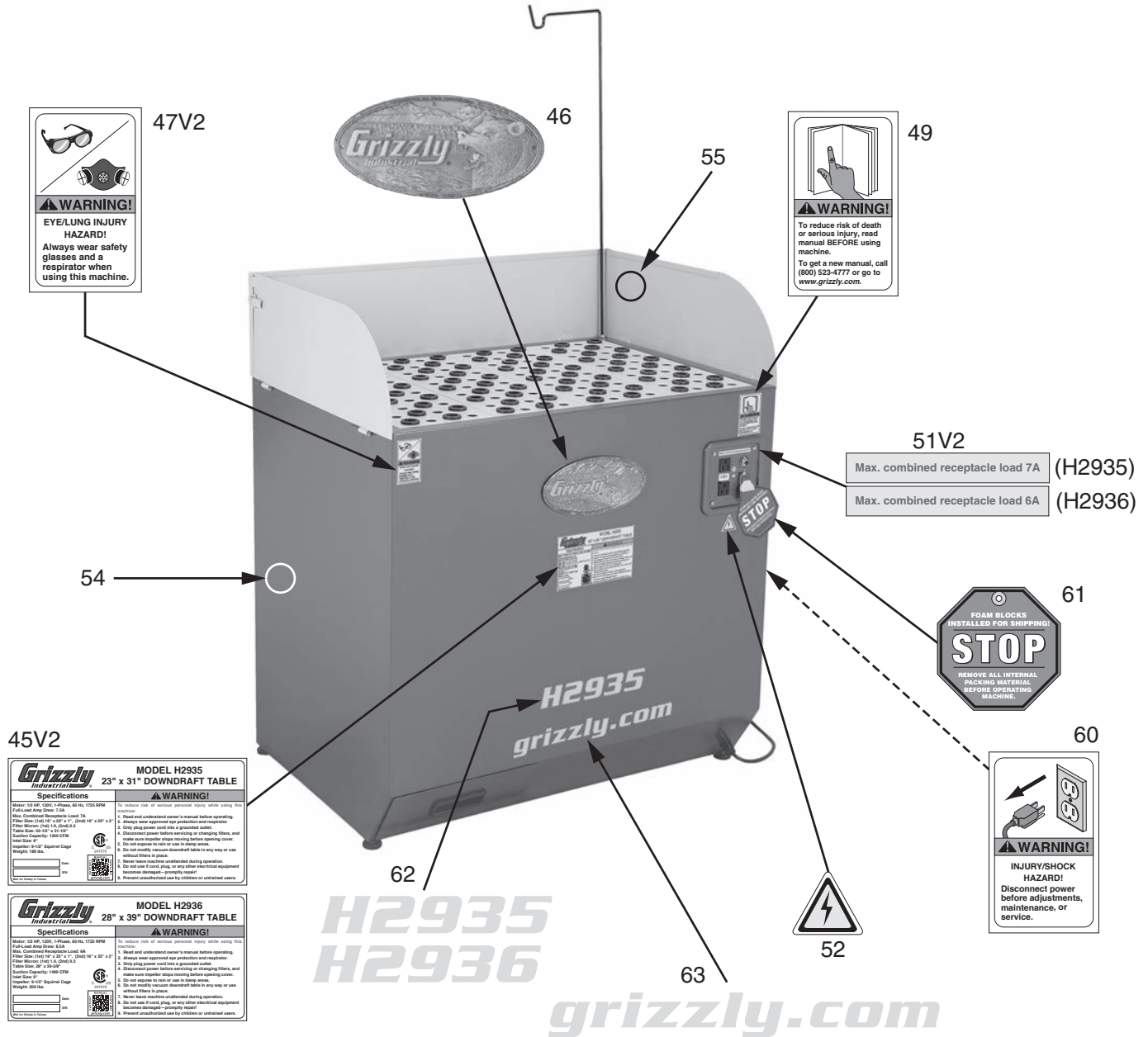
# H2936 Main Parts List

REF	PART #	DESCRIPTION
1	PH2936001	MAIN BASE
2	PH2936002	DUST COLLECTING PLATE 25-3/8 IN
3	PH2936003	GROMMET 31 X 22MM
4	PH2936004	CENTER PANEL
5	PH2936005	RIGHT PANEL
6	PH2936006	LEFT PANEL
7	PH2936007	FILTER 16"X 25" X 2"
8V2	PH2936008V2	OUTLET PLATE V2.04.09
9	PH2936009	FLANGE BOLT 1/4-20 X 1/2
10	PH2936010	CAP SCREW 1/4-20 X 1/2
11V2	PH2936011V2	FAN HOUSING V2.04.09
12V2	PH2936012V2	PLASTIC IMPELLER 7"T X 9.5"W V2.12.07
13V3	PH2936013V3	MOTOR 1/2HP 120V 1-PH V3.06.16
14	PH2936014	VIBRATION DAMPING MOTOR MOUNT
15	PH2936015	FLAT WASHER 1/4
17	PH2936017	HANDLE
18	PH2936018	DRAWER
19	PH2936019	FOOT PAD SCREW 3/8-16 X 2
20	PH2936020	HEX NUT 3/8-16
21	PH2936021	STRAIN RELIEF
22	PH2936022	POWER CORD 14G 3W 96" 5-15P
23	PH2936023	SWITCH PLATE
24	PH2936024	PADDLE SWITCH 110/220V WITH KEY

REF	PART #	DESCRIPTION
25	PH2936025	RECEPTACLE 110V
26	PH2936026	PHLP HD SCR 10-24 X 1
27	PH2936027	HEX NUT 3/4-16
28	PH2936028	PHLP HD SCR 10-24 X 1
29	PH2936029	POWER CORD CONNECTOR W
30	PH2936030	POWER CORD CONNECTOR B
31	PH2936031	GROUNDING CONNECTOR
32	PH2936032	HEX NUT 5/16-18
33	PH2936033	HANGER
34	PH2936034	SHORT CONNECTOR
35	PH2936035	CIRCUIT BREAKER KUOYUH 12A 125/250V
36	PH2936036	PHLP HD SCR 1/4-20 X 5/8
37	PH2936037	HANDLE
38	PH2936038	CAPACITOR COVER
39	PH2936039	EXT TOOTH WASHER #10
40	PH2936040	FILTER 16" X 25" X 1"
43	PH2936043	PANEL PIN
53	PH2936053	R CAPACITOR 50M 250V
56	PH2936056	PLASTIC SPACER
57	PH2936057	CAP SCREW M6-1 X 8
58	PH2936058	HEX BOLT 1/4-20 X 1-3/4
59	PH2936059	INLET COVER



# Labels & Cosmetics



REF	PART #	DESCRIPTION
45V2	PH2935045V2	MACHINE ID LABEL (H2935) V2.10.16
45V2	PH2936045V2	MACHINE ID LABEL (H2936) V2.10.16
46	PH2935046	GRIZZLY NAMEPLATE-SMALL
47V2	PH2935047V2	EYE/LUNG INJURY LABEL V2.10.16
49	PH2935049	READ MANUAL LABEL
51V2	PH2935051V2	MAXIMUM AMPS LABEL 7A (H2935) V2.10.16
51V2	PH2936051V2	MAXIMUM AMPS LABEL 6A (H2936) V2.10.16
52	PH2935052	ELECTRICITY LABEL

REF	PART #	DESCRIPTION
54	PH2935054	TOUCH-UP PAINT, GRIZZLY GREEN
55	PH2935055	TOUCH-UP PAINT, GRIZZLY PUTTY
60	PH2935060	DISCONNECT POWER LABEL
61	PH2935061	REMOVE FOAM STOP TAG
62	PH2935062	MODEL NUMBER LABEL (H2935)
62	PH2936062	MODEL NUMBER LABEL (H2936)
63	PH2935063	GRIZZLY.COM LABEL

**⚠ WARNING**

Safety labels help reduce the risk of serious injury caused by machine hazards. If any label comes off or becomes unreadable, the owner of this machine **MUST** replace it in the original location before resuming operations. For replacements, contact (800) 523-4777 or [www.grizzly.com](http://www.grizzly.com).



# WARRANTY & RETURNS

---

Grizzly Industrial, Inc. warrants every product it sells for a period of **1 year** to the original purchaser from the date of purchase. This warranty does not apply to defects due directly or indirectly to misuse, abuse, negligence, accidents, repairs or alterations or lack of maintenance. This is Grizzly's sole written warranty and any and all warranties that may be implied by law, including any merchantability or fitness, for any particular purpose, are hereby limited to the duration of this written warranty. We do not warrant or represent that the merchandise complies with the provisions of any law or acts unless the manufacturer so warrants. In no event shall Grizzly's liability under this warranty exceed the purchase price paid for the product and any legal actions brought against Grizzly shall be tried in the State of Washington, County of Whatcom.

We shall in no event be liable for death, injuries to persons or property or for incidental, contingent, special, or consequential damages arising from the use of our products.

The manufacturers reserve the right to change specifications at any time because they constantly strive to achieve better quality equipment. We make every effort to ensure that our products meet high quality and durability standards and we hope you never need to use this warranty.

In the event you need to use this warranty, contact us by mail or phone and give us all the details. We will then issue you a "Return Number," which must be clearly posted on the outside as well as the inside of the carton. We will not accept any item back without this number. Proof of purchase must accompany the merchandise.

Please feel free to write or call us if you have any questions about the machine or the manual.

Thank you again for your business and continued support. We hope to serve you again soon.

To take advantage of this warranty, you must register it at <https://www.grizzly.com/forms/warranty>, or you can scan the QR code below to be automatically directed to our warranty registration page. Enter all applicable information for the product.



# *grizzly.com*<sup>®</sup>

**TOOL WEBSITE**

Buy Direct and Save with Grizzly<sup>®</sup> – Trusted, Proven and a Great Value!  
~Since 1983~

*Visit Our Website Today For  
Current Specials!*

**ORDER  
24 HOURS A DAY!  
1-800-523-4777**

