

# *Grizzly* *Industrial, Inc.*®

## MODEL G0838 16" X 24" VARIABLE-SPEED WOOD LATHE OWNER'S MANUAL *(For models manufactured since 07/21)*



COPYRIGHT © MAY, 2018 BY GRIZZLY INDUSTRIAL, INC., REVISED APRIL, 2021 (MN)  
**WARNING: NO PORTION OF THIS MANUAL MAY BE REPRODUCED IN ANY SHAPE  
OR FORM WITHOUT THE WRITTEN APPROVAL OF GRIZZLY INDUSTRIAL, INC.**  
#BL19452 PRINTED IN CHINA

V4.04.21



## **WARNING!**

**This manual provides critical safety instructions on the proper setup, operation, maintenance, and service of this machine/tool. Save this document, refer to it often, and use it to instruct other operators.**

**Failure to read, understand and follow the instructions in this manual may result in fire or serious personal injury—including amputation, electrocution, or death.**

**The owner of this machine/tool is solely responsible for its safe use. This responsibility includes but is not limited to proper installation in a safe environment, personnel training and usage authorization, proper inspection and maintenance, manual availability and comprehension, application of safety devices, cutting/sanding/grinding tool integrity, and the usage of personal protective equipment.**

**The manufacturer will not be held liable for injury or property damage from negligence, improper training, machine modifications or misuse.**



## **WARNING!**

**Some dust created by power sanding, sawing, grinding, drilling, and other construction activities contains chemicals known to the State of California to cause cancer, birth defects or other reproductive harm. Some examples of these chemicals are:**

- **Lead from lead-based paints.**
- **Crystalline silica from bricks, cement and other masonry products.**
- **Arsenic and chromium from chemically-treated lumber.**

**Your risk from these exposures varies, depending on how often you do this type of work. To reduce your exposure to these chemicals: Work in a well ventilated area, and work with approved safety equipment, such as those dust masks that are specially designed to filter out microscopic particles.**

# Table of Contents

<b>INTRODUCTION</b> .....	<b>2</b>	<b>SECTION 5: ACCESSORIES</b> .....	<b>33</b>
Contact Info.....	2	<b>SECTION 6: MAINTENANCE</b> .....	<b>34</b>
Manual Accuracy .....	2	Schedule .....	34
Identification.....	3	Cleaning & Protecting .....	34
Controls & Components.....	4	Lubrication .....	34
Machine Data Sheet .....	5	<b>SECTION 7: SERVICE</b> .....	<b>35</b>
<b>SECTION 1: SAFETY</b> .....	<b>7</b>	Troubleshooting .....	35
Safety Instructions for Machinery .....	7	Tensioning & Replacing Belt.....	37
Additional Safety for Wood Lathes .....	9	Aligning Pulleys.....	38
<b>SECTION 2: POWER SUPPLY</b> .....	<b>10</b>	<b>SECTION 8: WIRING</b> .....	<b>39</b>
<b>SECTION 3: SETUP</b> .....	<b>12</b>	Wiring Safety Instructions .....	39
Needed for Setup.....	12	Wiring Diagram .....	40
Unpacking .....	12	Wiring Components .....	41
Inventory .....	13	<b>SECTION 9: PARTS</b> .....	<b>42</b>
Cleanup.....	14	Main .....	42
Site Considerations.....	15	Labels & Cosmetics .....	44
Assembly .....	16	<b>WARRANTY &amp; RETURNS</b> .....	<b>45</b>
Anchoring to Floor .....	17		
Test Run .....	18		
<b>SECTION 4: OPERATIONS</b> .....	<b>19</b>		
Operation Overview .....	19		
Workpiece Inspection.....	20		
Adjusting Headstock .....	20		
Adjusting Tailstock.....	21		
Adjusting Tool Rest.....	21		
Installing/Removing Headstock Center.....	22		
Installing/Removing Tailstock Center .....	23		
Installing Faceplate .....	24		
Changing Speed Ranges.....	25		
Indexing .....	27		
Spindle Turning.....	27		
Faceplate Turning.....	29		
Outboard Turning.....	31		
Sanding/Finishing .....	31		
Selecting Turning Tools.....	32		

# INTRODUCTION

## Contact Info

We stand behind our machines! If you have questions or need help, contact us with the information below. Before contacting, make sure you get the **serial number** and **manufacture date** from the machine ID label. This will help us help you faster.

Grizzly Technical Support  
1815 W. Battlefield  
Springfield, MO 65807  
Phone: (570) 546-9663  
Email: techsupport@grizzly.com

We want your feedback on this manual. What did you like about it? Where could it be improved? Please take a few minutes to give us feedback.

Grizzly Documentation Manager  
P.O. Box 2069  
Bellingham, WA 98227-2069  
Email: manuals@grizzly.com

## Manual Accuracy

We are proud to provide a high-quality owner's manual with your new machine!

We made every effort to be exact with the instructions, specifications, drawings, and photographs in this manual. Sometimes we make mistakes, but our policy of continuous improvement also means that **sometimes the machine you receive is slightly different than shown in the manual.**

If you find this to be the case, and the difference between the manual and machine leaves you confused or unsure about something, check our website for an updated version. We post current manuals and manual updates for free on our website at [www.grizzly.com](http://www.grizzly.com).

Alternatively, you can call our Technical Support for help. Before calling, make sure you write down the **Manufacture Date** and **Serial Number** from the machine ID label (see below). This information is required for us to provide proper tech support, and it helps us determine if updated documentation is available for your machine.

		MODEL GXXXX MACHINE NAME	
SPECIFICATIONS		▲ WARNING!	
Motor:	To reduce risk of serious injury when using this machine:		
Specification:	Read manual before operation.		
Specification:	Wear safety glasses and respirator.		
Specification:	Ensure safety glasses/respirator are properly adjusted/setup and		
Specification:	power is connected to grounded circuit before starting.		
Weight:	4. Make sure the motor has stopped and disconnect power before adjustments, maintenance, or service.		
	5. DO NOT expose to rain or dampness.		
	6. DO NOT modify this machine in any way.		
	7.		
	8.		
	9. Do not use while under the influence of drugs or alcohol.		
	10. Maintain machine carefully to prevent accidents.		
Manufactured for Grizzly in Taiwan			

**Manufacture Date** [ ]

**Serial Number** [ ]



# Identification

Become familiar with the names and locations of the controls and features shown below to better understand the instructions in this manual.

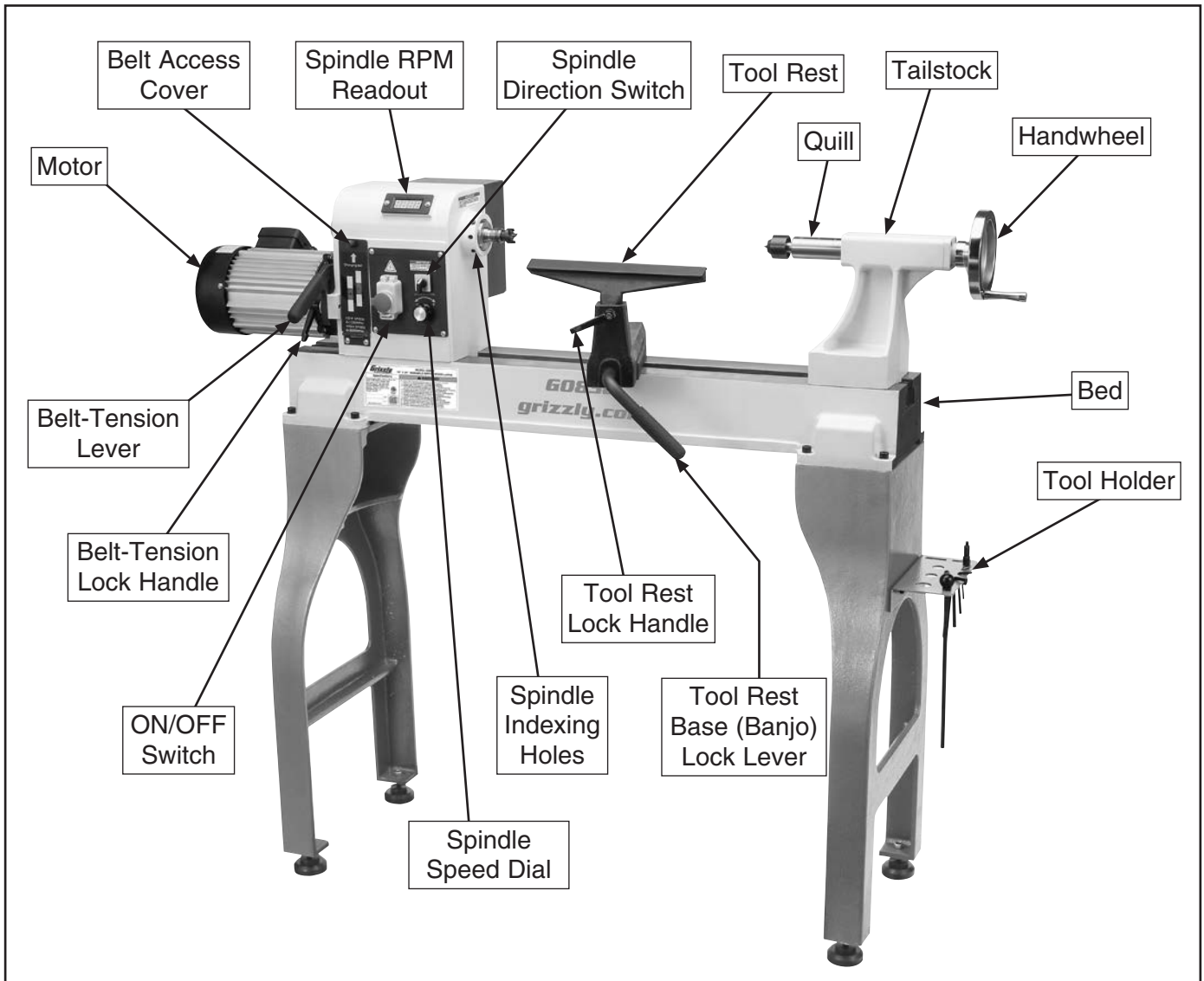

## **⚠️ WARNING**

**For Your Own Safety Read Instruction Manual Before Operating Lathe**

- a) **Wear eye protection.**
- b) **Do not wear gloves, necktie, or loose clothing.**
- c) **Tighten all locks before operating.**
- d) **Rotate workpiece by hand before applying power.**
- e) **Rough out workpiece before installing on faceplate.**
- f) **Do not mount split workpiece or one containing knot.**
- g) **Use lowest speed when starting new workpiece.**



# Controls & Components



Refer to **Figures 1–3** and the following descriptions to become familiar with the basic controls of this machine.

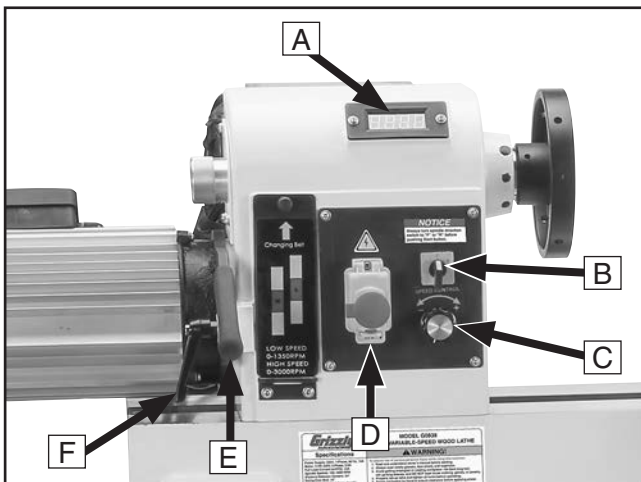

**Figure 1.** Headstock controls.

- A. Spindle RPM Readout:** Indicates spindle speed in rotations per minute (RPM).
- B. Spindle Direction Switch:** Toggles spindle direction between forward "F" (down toward operator) or reverse R (up away from the operator). In middle neutral position ("O") lathe will not turn ON.
- C. Spindle Speed Dial:** Adjusts spindle speed from low to high within range governed by pulley belt position.
- D. ON/OFF Switch w/Emergency Stop Button:** When pressed, cuts power to motor and control panel. To reset, press front tab, lift switch cover, and press green ON button. Cover must be unlatched for machine to run.

- E. Belt-Tension Lever:** Increases/decreases amount of tension on belt.
- F. Belt-Tension Lock Handle:** Locks belt tension lever in place.

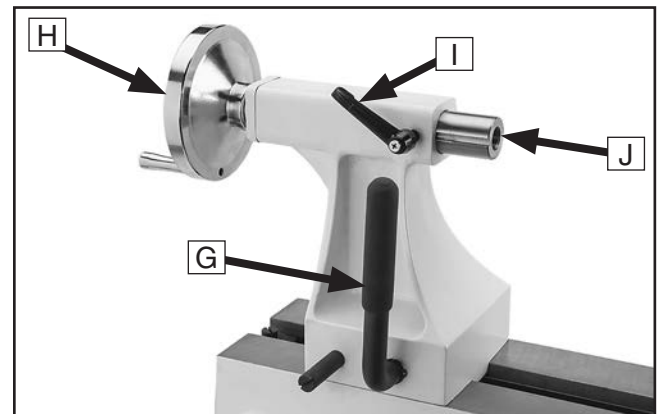

**Figure 2.** Tailstock controls.

- G. Tailstock Lock Lever:** Secures tailstock in position along bed.
- H. Tailstock Handwheel:** Moves quill toward or away from spindle.
- I. Quill Lock Handle:** Secures quill in position.
- J. Quill:** Holds centers or tooling. Can be moved toward or away from spindle.

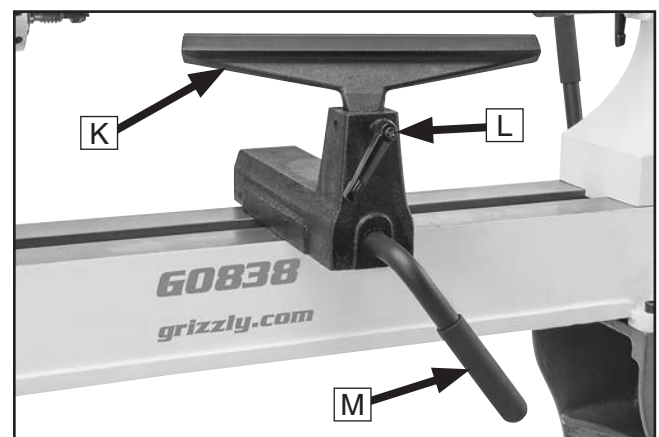

**Figure 3.** Tool rest controls.

- K. Tool Rest:** Provides stable platform for cutting tools.
- L. Tool Rest Lock Handle:** Secures tool rest in position.
- M. Tool Rest Base (Banjo) Lock Lever:** Secures tool rest base in position along bed.





# MACHINE DATA SHEET

Customer Service #: (570) 546-9663 · To Order Call: (800) 523-4777 · Fax #: (800) 438-5901

## MODEL G0838 16" X 24" VARIABLE-SPEED WOOD LATHE

### Product Dimensions:

Weight..... 322 lbs.  
 Width (side-to-side) x Depth (front-to-back) x Height..... 60-1/2 x 23-1/2 x 48 in.  
 Footprint (Length x Width)..... 42-1/2 x 16 in.

### Shipping Dimensions:

Type..... Wood Crate  
 Content..... Machine  
 Weight..... 388 lbs.  
 Length x Width x Height..... 45 x 23 x 21 in.

### Electrical:

Power Requirement..... 240V, Single-Phase, 60Hz  
 Full-Load Current Rating..... 9.5A  
 Minimum Circuit Size..... 15A  
 Connection Type..... Cord & Plug  
 Power Cord Included..... Yes  
 Power Cord Length..... 6 ft.  
 Power Cord Gauge..... 14 AWG  
 Plug Included..... Yes  
 Included Plug Type..... NEMA 6-15  
 Switch Type..... ON/OFF Push Button w/Safety Cover  
 Inverter (VFD) Type..... Delta VFD-MS  
 Inverter (VFD) Size..... 2 HP

### Motors:

#### Main

Horsepower..... 2 HP  
 Phase..... 3-Phase  
 Amps..... 5.6A  
 Speed..... 1720 RPM  
 Type..... TEFC Induction  
 Power Transfer ..... Belt Drive  
 Bearings..... Sealed & Permanently Lubricated

### Main Specifications:

#### Operation Information

Swing Over Bed..... 16 in.  
 Swing Over Tool Rest Base..... 11-1/2 in.  
 Distance Between Centers..... 24 in.  
 Max. Distance Tool Rest to Spindle Center..... 8-1/8 in.  
 No of Spindle Speeds..... Variable  
 Spindle Speed Range..... Low: 100–1300, High: 150–3200 RPM  
 Floor to Center Height..... 43-5/16 in.



**Spindle Information**

Spindle Taper..... MT#2  
Spindle Thread Size..... 1" x 8 TPI  
Spindle Thread Direction..... Right  
Spindle Bore..... 3/8 in.  
Type of Included Spindle Center..... Spur  
Indexed Spindle Increments..... 10, 30 deg.  
No of Indexes..... 12  
Outboard Spindle Thread Direction..... Right Hand  
Outboard Spindle Size..... M18  
Outboard Spindle TPI..... 1.5

**Tool Rest Information**

Tool Rest Width..... 12 in.  
Tool Rest Post Diameter..... 1 in.  
Tool Rest Post Length..... 2-1/8 in.  
Tool Rest Base Height..... 2-1/4 in.

**Tailstock Information**

Tailstock Taper..... MT#2  
Type of Included Tailstock Center..... Live

**Construction**

Bed..... Cast Iron  
Frame..... Cast Iron  
Stand..... Cast Iron  
Base..... Cast Iron  
Headstock..... Cast Iron  
Tailstock..... Cast Iron  
Paint Type/Finish..... Enamel

**Other Related Information**

Bed Width..... 6 in.  
Faceplate Size..... 6 in.

**Other Specifications:**

Country of Origin ..... China  
Warranty ..... 1 Year  
Serial Number Location ..... ID Label  
ISO 9001 Factory ..... Yes  
Certified by a Nationally Recognized Testing Laboratory (NRTL) ..... Yes

**Features:**

Digital Spindle Speed Indicator  
Spindle Low-Speed Range 100–1300 RPM  
Spindle High-Speed Range 150–3200 RPM  
Forward and Reverse Turning  
Cam Lock Adjustments for Fast and Easy Changes

**Accessories Included:**

6" Faceplate  
Live Center  
Spur Center  
Tool Holder  
Indexing Pin  
Knock-Out Tool





# SECTION 1: SAFETY

## For Your Own Safety, Read Instruction Manual Before Operating This Machine

The purpose of safety symbols is to attract your attention to possible hazardous conditions. This manual uses a series of symbols and signal words intended to convey the level of importance of the safety messages. The progression of symbols is described below. Remember that safety messages by themselves do not eliminate danger and are not a substitute for proper accident prevention measures. Always use common sense and good judgment.

**⚠ DANGER** Indicates an imminently hazardous situation which, if not avoided, **WILL** result in death or serious injury.

**⚠ WARNING** Indicates a potentially hazardous situation which, if not avoided, **COULD** result in death or serious injury.

**⚠ CAUTION** Indicates a potentially hazardous situation which, if not avoided, **MAY** result in minor or moderate injury. It may also be used to alert against unsafe practices.

**NOTICE** Alerts the user to useful information about proper operation of the machine to avoid machine damage.

## Safety Instructions for Machinery

### ⚠ WARNING

**OWNER'S MANUAL.** Read and understand this owner's manual **BEFORE** using machine.

**TRAINED OPERATORS ONLY.** Untrained operators have a higher risk of being hurt or killed. Only allow trained/supervised people to use this machine. When machine is not being used, disconnect power, remove switch keys, or lock-out machine to prevent unauthorized use—especially around children. Make your workshop kid proof!

**DANGEROUS ENVIRONMENTS.** Do not use machinery in areas that are wet, cluttered, or have poor lighting. Operating machinery in these areas greatly increases the risk of accidents and injury.

**MENTAL ALERTNESS REQUIRED.** Full mental alertness is required for safe operation of machinery. Never operate under the influence of drugs or alcohol, when tired, or when distracted.

**ELECTRICAL EQUIPMENT INJURY RISKS.** You can be shocked, burned, or killed by touching live electrical components or improperly grounded machinery. To reduce this risk, only allow qualified service personnel to do electrical installation or repair work, and always disconnect power before accessing or exposing electrical equipment.

**DISCONNECT POWER FIRST.** Always disconnect machine from power supply **BEFORE** making adjustments, changing tooling, or servicing machine. This prevents an injury risk from unintended startup or contact with live electrical components.

**EYE PROTECTION.** Always wear ANSI-approved safety glasses or a face shield when operating or observing machinery to reduce the risk of eye injury or blindness from flying particles. Everyday eyeglasses are **NOT** approved safety glasses.



# WARNING

**WEARING PROPER APPAREL.** Do not wear clothing, apparel or jewelry that can become entangled in moving parts. Always tie back or cover long hair. Wear non-slip footwear to reduce risk of slipping and losing control or accidentally contacting cutting tool or moving parts.

**HAZARDOUS DUST.** Dust created by machinery operations may cause cancer, birth defects, or long-term respiratory damage. Be aware of dust hazards associated with each workpiece material. Always wear a NIOSH-approved respirator to reduce your risk.

**HEARING PROTECTION.** Always wear hearing protection when operating or observing loud machinery. Extended exposure to this noise without hearing protection can cause permanent hearing loss.

**REMOVE ADJUSTING TOOLS.** Tools left on machinery can become dangerous projectiles upon startup. Never leave chuck keys, wrenches, or any other tools on machine. Always verify removal before starting!

**USE CORRECT TOOL FOR THE JOB.** Only use this tool for its intended purpose—do not force it or an attachment to do a job for which it was not designed. Never make unapproved modifications—modifying tool or using it differently than intended may result in malfunction or mechanical failure that can lead to personal injury or death!

**AWKWARD POSITIONS.** Keep proper footing and balance at all times when operating machine. Do not overreach! Avoid awkward hand positions that make workpiece control difficult or increase the risk of accidental injury.

**CHILDREN & BYSTANDERS.** Keep children and bystanders at a safe distance from the work area. Stop using machine if they become a distraction.

**GUARDS & COVERS.** Guards and covers reduce accidental contact with moving parts or flying debris. Make sure they are properly installed, undamaged, and working correctly BEFORE operating machine.

**FORCING MACHINERY.** Do not force machine. It will do the job safer and better at the rate for which it was designed.

**NEVER STAND ON MACHINE.** Serious injury may occur if machine is tipped or if the cutting tool is unintentionally contacted.

**STABLE MACHINE.** Unexpected movement during operation greatly increases risk of injury or loss of control. Before starting, verify machine is stable and mobile base (if used) is locked.

**USE RECOMMENDED ACCESSORIES.** Consult this owner's manual or the manufacturer for recommended accessories. Using improper accessories will increase the risk of serious injury.

**UNATTENDED OPERATION.** To reduce the risk of accidental injury, turn machine **OFF** and ensure all moving parts completely stop before walking away. Never leave machine running while unattended.

**MAINTAIN WITH CARE.** Follow all maintenance instructions and lubrication schedules to keep machine in good working condition. A machine that is improperly maintained could malfunction, leading to serious personal injury or death.

**DAMAGED PARTS.** Regularly inspect machine for damaged, loose, or mis-adjusted parts—or any condition that could affect safe operation. Immediately repair/replace BEFORE operating machine. For your own safety, DO NOT operate machine with damaged parts!

**MAINTAIN POWER CORDS.** When disconnecting cord-connected machines from power, grab and pull the plug—NOT the cord. Pulling the cord may damage the wires inside. Do not handle cord/plug with wet hands. Avoid cord damage by keeping it away from heated surfaces, high traffic areas, harsh chemicals, and wet/damp locations.

**EXPERIENCING DIFFICULTIES.** If at any time you experience difficulties performing the intended operation, stop using the machine! Contact our Technical Support at (570) 546-9663.



# Additional Safety for Wood Lathes

## **WARNING**

Serious injury or death can occur from getting entangled in, crushed between, or struck by rotating parts on a lathe! Rotating workpieces can come loose and strike operator or bystanders with deadly force if they are improperly secured, rotated too fast, or are not strong enough for the rotational forces required for turning. Improper tool setup or usage can cause tool kickback or grabbing, resulting in impact injury or entanglement. To reduce the risk of operator (or bystander) injury or death, anyone operating this machine **MUST** completely heed the hazards and warnings below.

**VERIFY WORKPIECE INTEGRITY.** Verify each workpiece is free of knots, splits, nails, or foreign material to ensure it can safely rotate on spindle without breaking apart or causing tool kickback.

**PROPERLY PREPARE WORKPIECE.** Before mounting, cut off waste portions to balance workpiece for safe rotation and removal of large edges that can catch on tooling.

**SECURE LOCKS.** Verify tool rest, headstock, and tailstock are secure before turning lathe **ON**.

**SECURE WORKPIECE.** Use proven setup techniques and always verify workpiece (and centers/tooling holding workpiece) are well-secured before starting lathe. Only use high-quality fasteners with non-tapered heads for faceplate attachment.

**ADJUST TOOL SUPPORT.** An improperly supported tool may be grabbed or ejected. Adjust tool rest approximately  $\frac{1}{4}$ " away from workpiece and  $\frac{1}{8}$ " above workpiece center line to provide proper support for turning tool. Firmly hold turning tool with both hands against tool rest.

**REMOVE ADJUSTMENT TOOLS.** Remove all chuck keys, wrenches, and adjustment tools before turning lathe **ON**. These items can become deadly projectiles when spindle is started.

**CHECK CLEARANCES.** Before starting spindle, verify workpiece has adequate clearance by hand-rotating it through its entire range of motion.

**TEST NEW SETUPS.** Test each new setup by starting spindle rotation at lowest speed and standing to side of lathe until workpiece reaches full speed and you can verify safe rotation.

**WEAR PROPER PPE.** Always wear a face shield and safety glasses when operating lathe. Do not wear gloves, necktie or loose clothing. Keep long hair away from rotating spindle.

**USE CORRECT SPEEDS.** Select correct spindle speed for workpiece size, type, shape, and condition. Use low speeds when roughing or when turning large, long, or non-concentric workpieces. Allow spindle to reach full speed before turning.

**AVOID TOOL KICKBACK.** This occurs when turning tool is grabbed or ejected from workpiece with great force. Commonly caused by poor workpiece selection/preparation, improper tool usage, or improper machine setup or tool rest adjustment.

**SAFELY PERFORM ROUGHING.** Use correct tool. Take light cuts, use low speeds, and firmly support tool with both hands.

**USE SHARP TOOLS.** Sharp tools cut with less resistance than dull tools. Using dull tools increases the risk of tool kickback or grabbing.

**SAFELY STOPPING ROTATION.** Always allow rotating workpiece to stop on its own. Never put hands or another object on workpiece to stop it.

**SAFELY MEASURE WORKPIECE.** Only measure mounted workpiece after it has completely stopped. Trying to measure a spinning workpiece increases entanglement risk.

**SANDING/POLISHING.** To reduce entanglement risk, remove tool rest before sanding. Never completely wrap sandpaper around workpiece.



# SECTION 2: POWER SUPPLY

## Availability

Before installing the machine, consider the availability and proximity of the required power supply circuit. If an existing circuit does not meet the requirements for this machine, a new circuit must be installed. To minimize the risk of electrocution, fire, or equipment damage, installation work and electrical wiring must be done by an electrician or qualified service personnel in accordance with all applicable codes and standards.

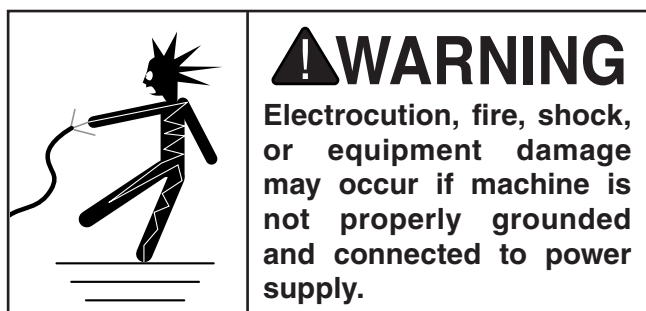

## Full-Load Current Rating

The full-load current rating is the amperage a machine draws at 100% of the rated output power. On machines with multiple motors, this is the amperage drawn by the largest motor or sum of all motors and electrical devices that might operate at one time during normal operations.

### Full-Load Current Rating at 240V .... 9.5 Amps

The full-load current is not the maximum amount of amps that the machine will draw. If the machine is overloaded, it will draw additional amps beyond the full-load rating.

If the machine is overloaded for a sufficient length of time, damage, overheating, or fire may result—especially if connected to an undersized circuit. To reduce the risk of these hazards, avoid overloading the machine during operation and make sure it is connected to a power supply circuit that meets the specified circuit requirements.

## Circuit Information

A power supply circuit includes all electrical equipment between the breaker box or fuse panel in the building and the machine. The power supply circuit used for this machine must be sized to safely handle the full-load current drawn from the machine for an extended period of time. (If this machine is connected to a circuit protected by fuses, use a time delay fuse marked D.)

**! CAUTION**  
For your own safety and protection of property, consult an electrician if you are unsure about wiring practices or electrical codes in your area.

**Note:** *Circuit requirements in this manual apply to a dedicated circuit—where only one machine will be running on the circuit at a time. If machine will be connected to a shared circuit where multiple machines may be running at the same time, consult an electrician or qualified service personnel to ensure circuit is properly sized for safe operation.*

## Circuit Requirements

This machine is prewired to operate on a power supply circuit that has a verified ground and meets the following requirements:

**Nominal Voltage** ..... 208V, 220V, 230V, 240V  
**Cycle** ..... 60 Hz  
**Phase** ..... Single-Phase  
**Power Supply Circuit** ..... 15 Amps  
**Plug/Receptacle** ..... NEMA 6-15



## Grounding Requirements

This machine **MUST** be grounded. In the event of certain malfunctions or breakdowns, grounding reduces the risk of electric shock by providing a path of least resistance for electric current.

This machine is equipped with a power cord that has an equipment-grounding wire and a grounding plug. Only insert plug into a matching receptacle (outlet) that is properly installed and grounded in accordance with all local codes and ordinances. **DO NOT** modify the provided plug!

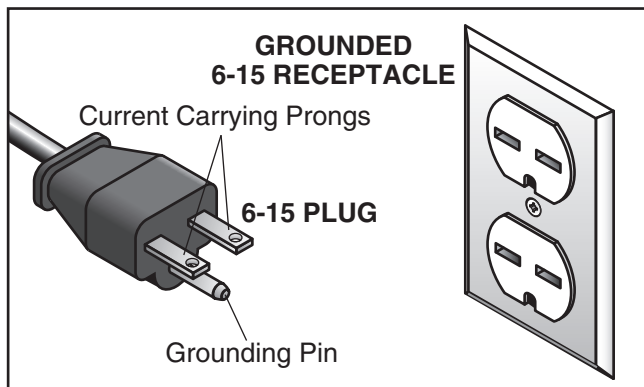
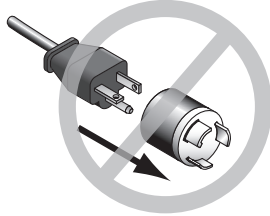

Figure 4. Typical 6-15 plug and receptacle.

## CAUTION



**No adapter should be used with plug. If plug does not fit available receptacle, or if machine must be reconnected for use on a different type of circuit, reconnection must be performed by an electrician or qualified service personnel, and it must comply with all local codes and ordinances.**

## WARNING

**Serious injury could occur if you connect machine to power before completing setup process. DO NOT connect to power until instructed later in this manual.**

Improper connection of the equipment-grounding wire can result in a risk of electric shock. The wire with green insulation (with or without yellow stripes) is the equipment-grounding wire. If repair or replacement of the power cord or plug is necessary, do not connect the equipment-grounding wire to a live (current carrying) terminal.

Check with a qualified electrician or service personnel if you do not understand these grounding requirements, or if you are in doubt about whether the tool is properly grounded. If you ever notice that a cord or plug is damaged or worn, disconnect it from power, and immediately replace it with a new one.

## Extension Cords

We do not recommend using an extension cord with this machine. If you must use an extension cord, only use it if absolutely necessary and only on a temporary basis.

Extension cords cause voltage drop, which can damage electrical components and shorten motor life. Voltage drop increases as the extension cord size gets longer and the gauge size gets smaller (higher gauge numbers indicate smaller sizes).

Any extension cord used with this machine must be in good condition and contain a ground wire and matching plug/receptacle. Additionally, it must meet the following size requirements:

**Minimum Gauge Size ..... 14 AWG**  
**Maximum Length (Shorter is Better).....50 ft.**



# SECTION 3: SETUP

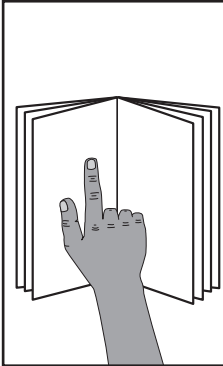

## **!WARNING**

This machine presents serious injury hazards to untrained users. Read through this entire manual to become familiar with the controls and operations before starting the machine!

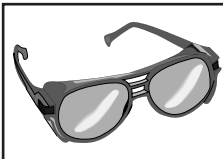

## **!WARNING**

Wear safety glasses during the entire setup process!



## **!WARNING**

### **HEAVY LIFT!**

Straining or crushing injury may occur from improperly lifting machine or some of its parts. To reduce this risk, get help from other people and use a forklift (or other lifting equipment) rated for weight of this machine.

## Needed for Setup

The following items are needed, but not included, for the setup/assembly of this machine.

Description	Qty
• Additional People .....	As Needed
• Safety Glasses (for each person).....	1
• Level .....	1
• Cleaner/Degreaser ( <b>Page 14</b> ) ....	As Needed
• Disposable Shop Rags.....	As Needed

## Unpacking

This machine was carefully packaged for safe transport. When unpacking, separate all enclosed items from packaging materials and inspect them for shipping damage. ***If items are damaged, please call us immediately at (570) 546-9663.***

**IMPORTANT:** Save all packaging materials until you are completely satisfied with the machine and have resolved any issues between Grizzly or the shipping agent. ***You MUST have the original packaging to file a freight claim. It is also extremely helpful if you need to return your machine later.***



# Inventory

The following is a list of items shipped with your machine. Before beginning setup, lay these items out and inventory them.

If any non-proprietary parts are missing (e.g. a nut or a washer), we will gladly replace them; or for the sake of expediency, replacements can be obtained at your local hardware store.

## NOTICE

If you cannot find an item on this list, carefully check around/inside the machine and packaging materials. Often, these items get lost in packaging materials while unpacking or they are pre-installed at the factory.

B.	Stand Legs .....	2
C.	Machine Feet w/Hex Nuts .....	4
D.	Tool Holder .....	1
E.	Knockout Tool.....	1
F.	Spur Center MT#2 .....	1
G.	Live Center MT#2 .....	1
H.	Indexing Pin.....	1
I.	Hex Wrenches 3, 4, 6, 8mm.....	1 Ea
J.	Hardware	
	—Cap Screws M10-1.5 x 35.....	8
	—Lock Washers 10mm .....	8
	—Cap Screws M8-1.25 x 15.....	2
	—Lock Washers 8mm.....	2

Inventory (Figures 5–7)	Qty
A. Lathe Assembly	
—Headstock (mounted) .....	1
—Tool Rest Base (mounted) .....	1
—Tailstock (mounted).....	1
—Faceplate 6" (installed) .....	1

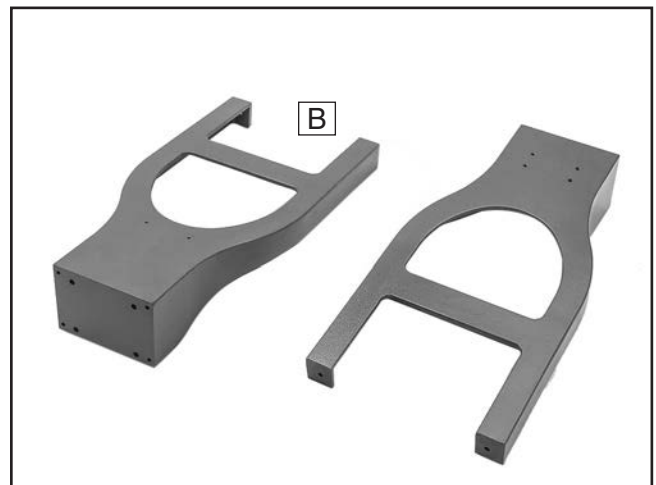

Figure 6. Stand legs.

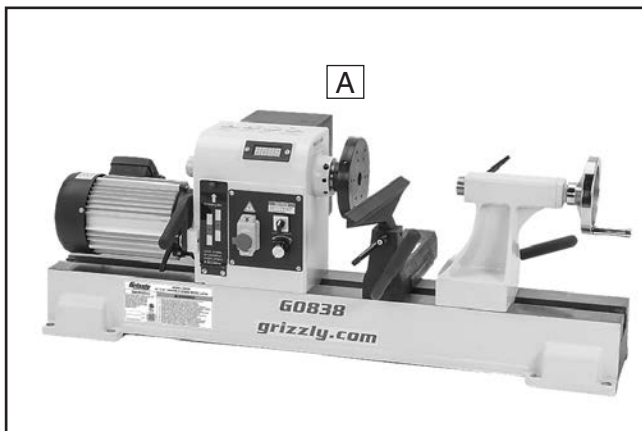

Figure 5. Lathe assembly.

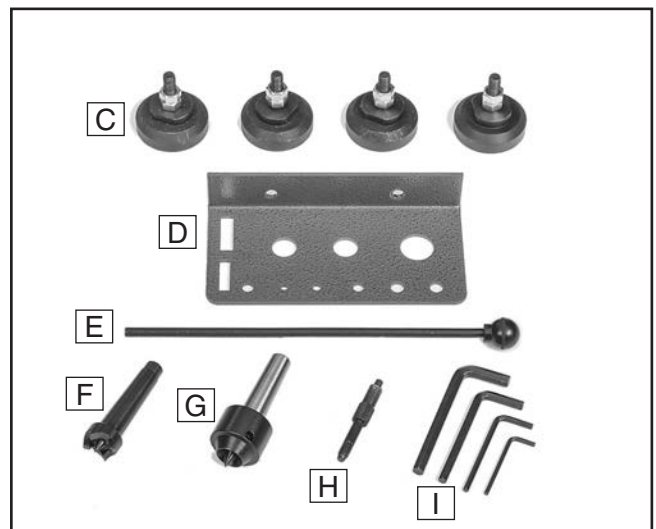

Figure 7. Loose inventory components.



# Cleanup

The unpainted surfaces of your machine are coated with a heavy-duty rust preventative that prevents corrosion during shipment and storage. This rust preventative works extremely well, but it will take a little time to clean.

Be patient and do a thorough job cleaning your machine. The time you spend doing this now will give you a better appreciation for the proper care of your machine's unpainted surfaces.

There are many ways to remove this rust preventative, but the following steps work well in a wide variety of situations. Always follow the manufacturer's instructions with any cleaning product you use and make sure you work in a well-ventilated area to minimize exposure to toxic fumes.

## Before cleaning, gather the following:

- Disposable rags
- Cleaner/degreaser (WD•40 works well)
- Safety glasses & disposable gloves
- Plastic paint scraper (optional)

## Basic steps for removing rust preventative:

1. Put on safety glasses.
2. Coat the rust preventative with a liberal amount of cleaner/degreaser, then let it soak for 5–10 minutes.
3. Wipe off the surfaces. If your cleaner/degreaser is effective, the rust preventative will wipe off easily. If you have a plastic paint scraper, scrape off as much as you can first, then wipe off the rest with the rag.
4. Repeat **Steps 2–3** as necessary until clean, then coat all unpainted surfaces with a quality metal protectant to prevent rust.

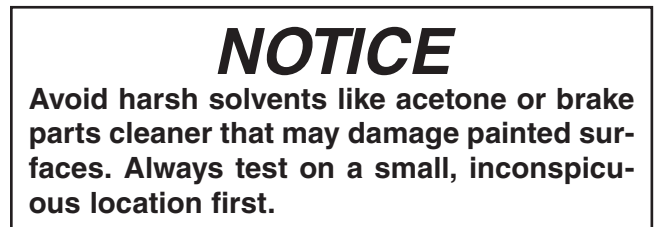
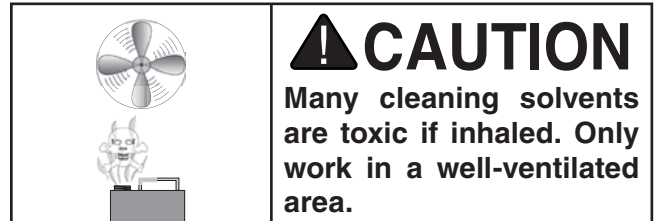
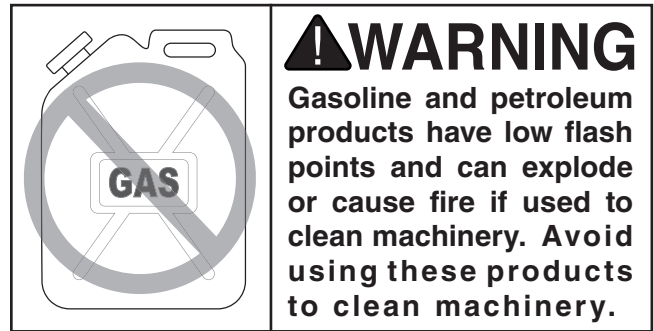

## T23692—Orange Power Degreaser

A great product for removing the waxy shipping grease from the **non-painted** parts of the machine during clean up.



Figure 8. T23692 Orange Power Degreaser.





# Site Considerations

## Weight Load

Refer to the **Machine Data Sheet** for the weight of your machine. Make sure that the surface upon which the machine is placed will bear the weight of the machine, additional equipment that may be installed on the machine, and the heaviest workpiece that will be used. Additionally, consider the weight of the operator and any dynamic loading that may occur when operating the machine.

## Space Allocation

Consider the largest size of workpiece that will be processed through this machine and provide enough space around the machine for adequate operator material handling or the installation of auxiliary equipment. With permanent installations, leave enough space around the machine to open or remove doors/covers as required by the maintenance and service described in this manual. **See below for required space allocation.**

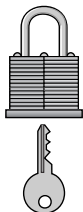
	<p><b>CAUTION</b></p> <p>Children or untrained people may be seriously injured by this machine. Only install in an access restricted location.</p>
---	--

## Physical Environment

The physical environment where the machine is operated is important for safe operation and longevity of machine components. For best results, operate this machine in a dry environment that is free from excessive moisture, hazardous chemicals, airborne abrasives, or extreme conditions. Extreme conditions for this type of machinery are generally those where the ambient temperature range exceeds 41°–104°F; the relative humidity range exceeds 20%–95% (non-condensing); or the environment is subject to vibration, shocks, or bumps.

## Electrical Installation

Place this machine near an existing power source. Make sure all power cords are protected from traffic, material handling, moisture, chemicals, or other hazards. Make sure to leave enough space around machine to disconnect power supply or apply a lockout/tagout device, if required.

## Lighting

Lighting around the machine must be adequate enough that operations can be performed safely. Shadows, glare, or strobe effects that may distract or impede the operator must be eliminated.

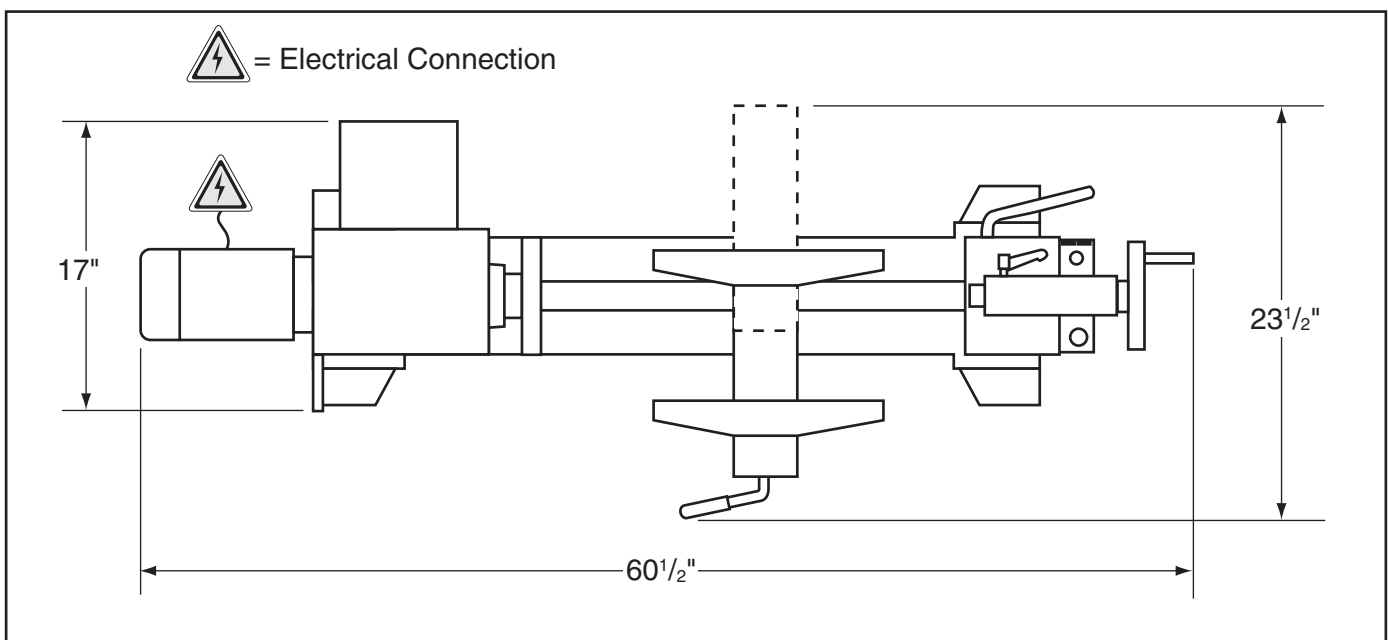

**Figure 9.** Minimum working clearances.



# Assembly

The machine must be fully assembled before it can be operated. Before beginning the assembly process, refer to **Needed for Setup** and gather all listed items. To ensure the assembly process goes smoothly, first clean any parts that are covered or coated in heavy-duty rust preventative (if applicable).

## To assemble machine:

1. Position stand legs upright approximately 37" apart, and get them reasonably aligned (see **Figure 10**).

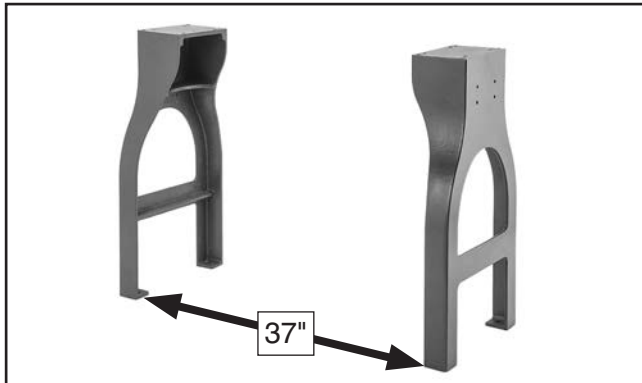

**Figure 10.** Supporting legs positioned 37" apart.

2. Carefully position lathe assembly on top of stands and align mounting holes.
3. Secure lathe assembly to stand legs with (8) M10-1.5 x 35 cap screws and 10mm lock washers, as shown in **Figure 11**.



**Figure 11.** Securing lathe assembly.

4. If bolting lathe to floor, skip to **Step 7**. Otherwise, move tailstock, tool rest assembly, and headstock to one end of lathe bed way (refer to **Operations**, beginning on **Page 19**).
5. Use assistants to lift one end of lathe onto support blocks and stabilize lathe in preparation for installing machine feet (see **Figure 12**).

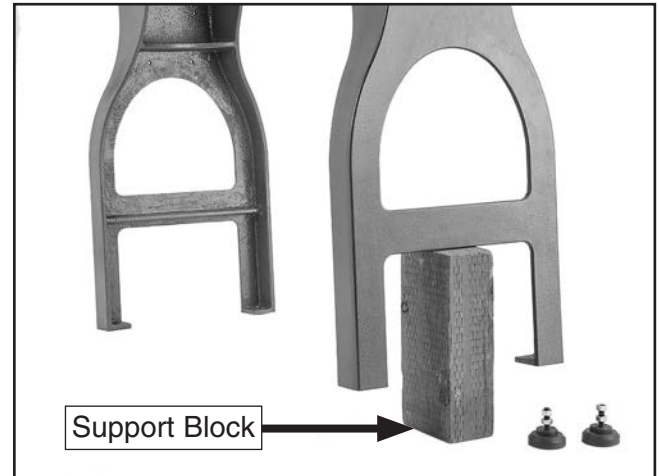

**Figure 12.** Legs supported for feet installation.

6. Remove top hex nut from feet, insert feet in mounting holes in leg (see **Figure 13**), then thread top hex nut back on. Do not tighten hex nuts yet. Remove supporting block and repeat **Steps 5–6** on other leg.

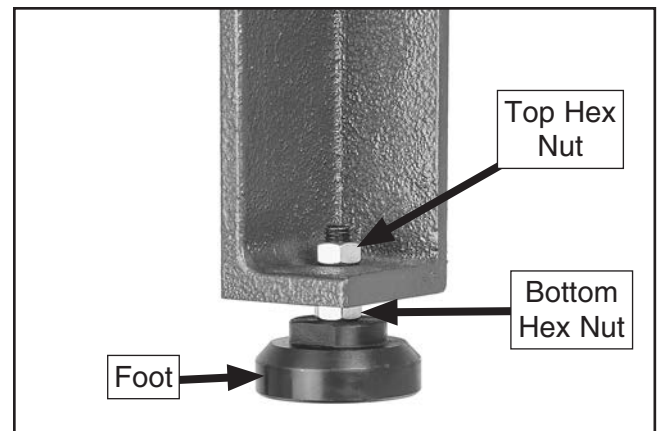

**Figure 13.** 1 of 4 machine feet installed.



7. Place level on lathe bed and make necessary adjustments so bed is level from side-to-side and front-to-back.

— If you are using machine feet, adjust top and bottom hex nuts on each foot to level bed; then tighten hex nuts to secure these adjustments.

— If you are bolting lathe to floor, use shims under legs to level bed; then tighten mounting fasteners.

8. Attach tool holder to right leg using remaining (2) M8-1.25 x 15 cap screws and (2) 8mm lock washers, as shown in **Figure 14**.

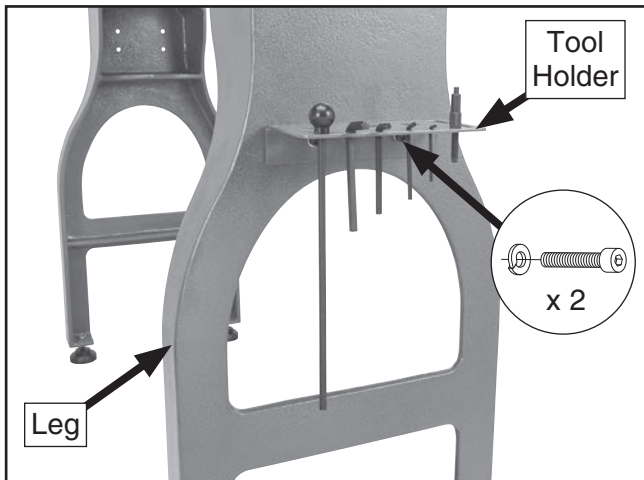

**Figure 14.** Tool holder attached to leg.

# Anchoring to Floor

**Number of Mounting Holes** ..... 4  
**Diameter of Mounting Hardware**..... 3/8"

Anchoring machinery to the floor prevents tipping or shifting and reduces vibration that may occur during operation, resulting in a machine that runs slightly quieter and feels more solid.

If the machine will be installed in a commercial or workplace setting, or if it is permanently connected (hardwired) to the power supply, local codes may require that it be anchored to the floor.

If not required by any local codes, fastening the machine to the floor is an optional step. If you choose not to do this with your machine, we recommend placing it on machine mounts, as these provide an easy method for leveling and they have vibration-absorbing pads.

## Anchoring to Concrete Floors

Lag shield anchors with lag screws (see below) are a popular way to anchor machinery to a concrete floor, because the anchors sit flush with the floor surface, making it easy to unbolt and move the machine later, if needed. However, anytime local codes apply, you **MUST** follow the anchoring methodology specified by the code.

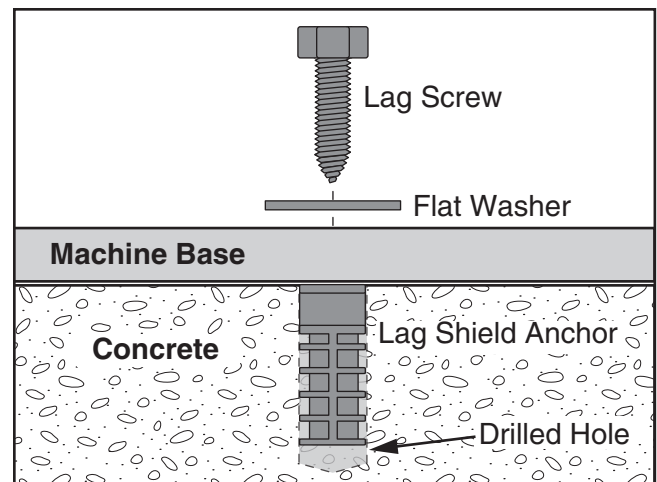

**Figure 15.** Popular method for anchoring machinery to a concrete floor.



# Test Run

Once assembly is complete, test run the machine to ensure it is properly connected to power and safety components are functioning correctly.

If you find an unusual problem during the test run, immediately stop the machine, disconnect it from power, and fix the problem **BEFORE** operating the machine again. The **Troubleshooting** table in the **SERVICE** section of this manual can help.

The test run consists of verifying the following:  
1) The motor powers up and runs correctly, and  
2) the safety disabling mechanism on the switch works correctly.

## **!WARNING**

**Serious injury or death can result from using this machine BEFORE understanding its controls and related safety information. DO NOT operate, or allow others to operate, machine until the information is understood.**

## **!WARNING**

**DO NOT start machine until all preceding setup instructions have been performed. Operating an improperly set up machine may result in malfunction or unexpected results that can lead to serious injury, death, or machine/property damage.**

### To test run machine:

1. Clear all setup tools away from machine.
2. Connect machine to power supply.
3. Set spindle direction switch to neutral or "O" position and turn spindle speed dial all the way counterclockwise, as shown in **Figure 16**.
4. Squeeze tab on bottom of Emergency Stop button (see **Figure 16**), lift button to open switch cover, and press green ON button to start machine. Spindle RPM readout should illuminate.

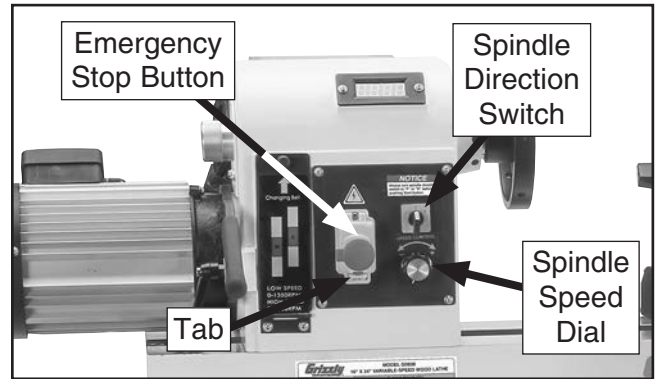

**Figure 16.** Location of headstock controls.

5. Verify machine is operating correctly by turning spindle direction switch to "R" position, then slowly turn spindle speed dial to right.
  - When operating correctly, machine runs smoothly with little or no vibration or rubbing noises.
  - Investigate and correct strange or unusual noises or vibrations before operating machine further. Always disconnect machine from power when investigating or correcting potential problems.
6. Turn spindle speed dial all the way left.
7. Turn spindle direction switch to "F" position, and slowly turn spindle speed dial to right.
  - When operating correctly, machine runs smoothly with little or no vibration or rubbing noises.
8. Move spindle direction switch to "O" position, and push in Emergency Stop button.
9. Without opening Emergency Stop button, turn spindle direction switch to "R" and "F" positions. Machine should not start.
  - If machine *does not* start, Emergency Stop button safety feature is working correctly. Test run is complete.
  - If machine *does* start (with Emergency Stop button pushed in), immediately disconnect power to machine. Emergency Stop button safety feature is not working correctly. This safety feature must work properly before proceeding with regular operations. Call Tech Support for help.



# SECTION 4: OPERATIONS

## Operation Overview

The purpose of this overview is to provide the novice machine operator with a basic understanding of how the machine is used during operation, so the machine controls/components discussed later in this manual are easier to understand.

Due to the generic nature of this overview, it is **not** intended to be an instructional guide. To learn more about specific operations, read this entire manual, seek additional training from experienced machine operators, and do additional research outside of this manual by reading "how-to" books, trade magazines, or websites.

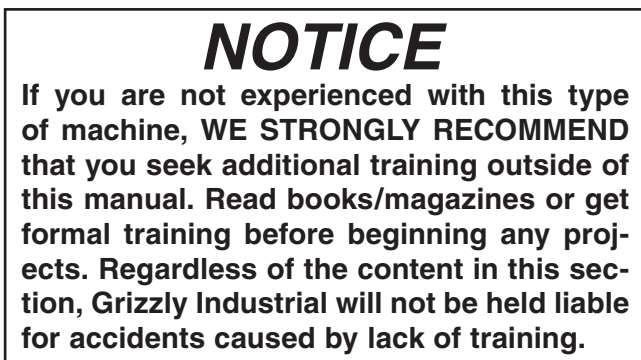
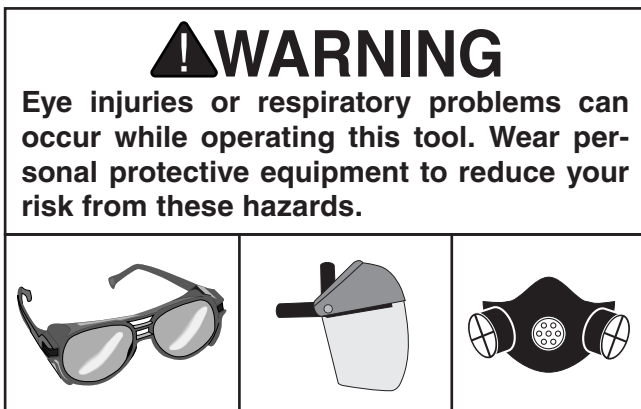

To complete a typical operation, the operator does the following:

1. Examines workpiece to make sure it is suitable for turning. No extreme bows, knots, or cracks should exist.
2. Prepares and trims up workpiece with a bandsaw or table saw to make it roughly concentric.
3. Installs workpiece between centers, or attaches it to faceplate or chuck.
4. Adjusts tool rest according to type of operation, and sets minimum clearance between workpiece and lip of tool rest to 1/4" gap.
5. Rotates workpiece by hand to verify spindle and workpiece rotate freely throughout full range of motion.
6. Verifies pulley speed range is set for type of wood and size of workpiece installed.
7. Verifies spindle direction switch is in "O" position and spindle speed dial is turned all the way counterclockwise so spindle does not start in high speed.
8. Ties back long hair and clothing and puts on safety glasses, face shield, and respirator.
9. Sets spindle direction switch to forward or reverse, starts spindle, adjusts spindle speed, and carefully begins turning operation, keeping chisel against tool rest entire time it is cutting.
10. Turns spindle **OFF** when cutting operation is complete.



# Workpiece Inspection

Some workpieces are not safe to turn or may require modification before they are safe to turn. **Before turning, inspect all workpieces for the following:**

- **Workpiece Type:**  
This machine is intended for turning natural wood products. Never attempt to turn any composite wood materials, plastics, metal, stone, or rubber workpieces; turning these materials can lead to machine damage or severe injury.
- **Foreign Objects:**  
Nails, staples, dirt, rocks and other foreign objects are often embedded in wood. While cutting, these objects can become dislodged and hit the operator, cause tool grab, or break the turning tool, which might then fly apart. Always visually inspect your workpiece for these items. If they can't be removed, DO NOT turn the workpiece.
- **Large/Loose Knots:**  
Loose knots can become dislodged during the turning operation. Large knots can cause a workpiece to completely break in half during turning and cause machine damage and injury. Choose workpieces that do not have large/loose knots.
- **Excessive Warping:**  
Workpieces with excessive bowing or twisting are unstable and unbalanced. Never turn these workpieces at high speed, or instability will be magnified and the workpiece can be ejected from the lathe causing injury. Only turn concentric workpieces!

# Adjusting Headstock

The Model G0838 headstock is equipped with a cam-action clamping system to secure it to the lathe bed. When the lever is tightened, a locking plate lifts up underneath the bed and secures the headstock in place. The headstock can be positioned anywhere along the lathe bed.

**To position headstock along length of bed:**

1. DISCONNECT MACHINE FROM POWER!
2. Loosen headstock lock lever (see **Figure 17**).

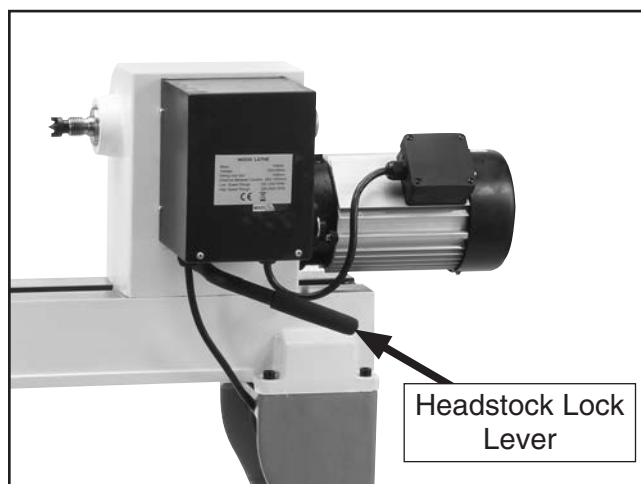

**Figure 17.** Location of headstock lock lever.

3. Slide headstock to desired location on bed, and use headstock lock lever to secure headstock in position.

**Note:** *The large clamping hex nut underneath the headstock will require occasional adjusting to ensure proper clamping pressure of the headstock to the bed. Turn this hex nut in small increments to fine tune the clamping pressure as needed.*

## **!WARNING**

**Always operate lathe with headstock firmly locked to bed. Otherwise, serious personal injury may occur, as workpiece or faceplate could shift during operation or be ejected from lathe.**



# Adjusting Tailstock

The tailstock adjusts in the same manner as the headstock.

## To position tailstock along length of bed:

1. Loosen tailstock lock lever and move tailstock to desired position along bed, as shown in **Figure 18**.

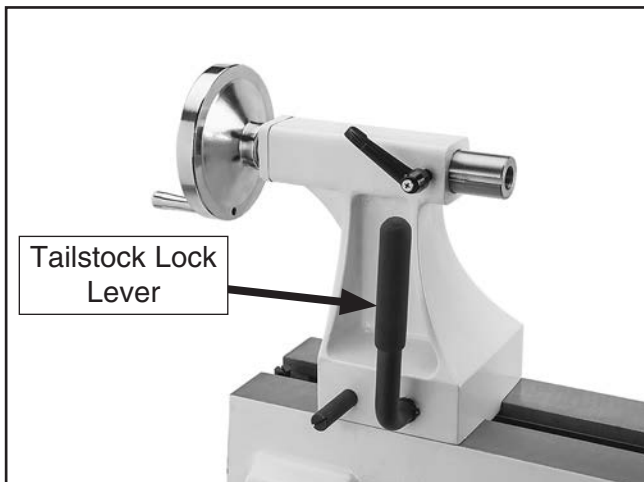

**Figure 18.** Tailstock lock lever location.

2. Re-tighten tailstock lock lever to secure tailstock to bed.

**Note:** *The large clamping hex nut underneath the tailstock will require occasional adjusting to ensure proper clamping pressure of the tailstock to the bed. Turn this hex nut in small increments to fine tune the clamping pressure as needed.*

## **WARNING**

Always operate lathe with tailstock firmly locked to bed. Otherwise, serious personal injury may occur if tailstock moves/shifts during operation.

# Adjusting Tool Rest

The tool rest assembly consists of two components: the tool rest base (or banjo) and the tool rest. The tool rest base moves forward/backward and along the length of the lathe bed. The tool rest rotates and moves up and down in the tool rest base. Locks for both components allow you to secure the tool rest in position after making these adjustments.

When adjusting the tool rest, position it as close as possible to the workpiece without actually touching it. This maximizes support where the cutting occurs and minimizes leverage, reducing the risk of injury if a "catch" occurs.

Many woodturners typically set the height of the tool rest  $\frac{1}{8}$ " above or below the centerline of the workpiece, depending on their height, the type of tool they're using, and the type of operation they're performing.

**As a rule of thumb:** For most (spindle) turning operations, the cutting tool should contact the workpiece slightly above centerline. For most inside (bowl) turning operations, the cutting tool should contact the workpiece slightly below centerline.

Keeping all these factors in mind, your main goal when adjusting the tool rest should be providing maximum support for the type of tool being used, in a position that is safe and comfortable for you.

## **WARNING**

Improperly supported or positioned cutting tools can "catch" on workpiece, ejecting tool from your hands with great force. To reduce this risk, always ensure tool rest is properly positioned for each type of operation, cutting tool is firmly supported against tool rest **BEFORE** cutting, and cutting tool is properly positioned to cut at the correct angle for tool and operation type.



## To adjust tool rest:

1. Loosen tool rest base lock lever and move tool rest assembly to desired position on lathe bed, as shown in **Figure 19**.

**Note:** To maximize support, the tool rest base should always be locked on both sides of the bed. Never pull the tool rest so far back that it is only secured on one side.

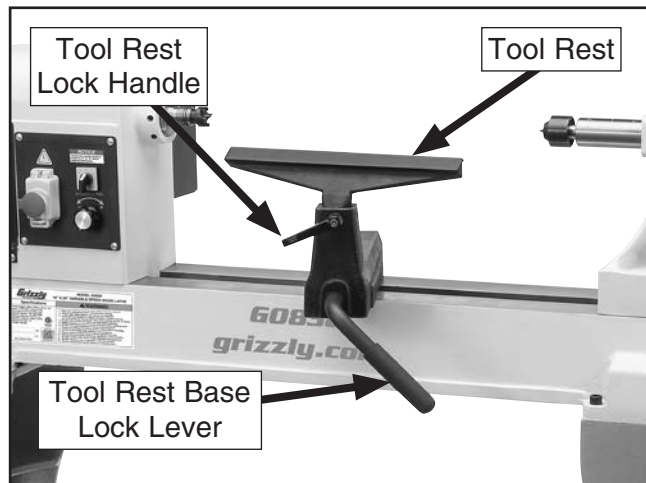

**Figure 19.** Tool rest controls.

2. Tighten tool rest base lock lever to secure tool rest assembly in position.

**Note:** The large clamping hex nut underneath the tool rest base will require occasional adjusting to ensure proper clamping pressure of the tool rest assembly to the bed. Turn this hex nut in small increments to fine tune the clamping pressure as needed.

## **!WARNING**

**Always operate lathe with tool rest assembly firmly locked in position. Otherwise, serious personal injury may occur by tool being pulled from operator's hands.**

3. Loosen tool rest lock handle (see **Figure 19**).
4. Position tool rest in desired location.
5. Tighten tool rest lock handle to secure tool rest in position.

# Installing/Removing Headstock Center

The included spur center installs in the headstock spindle with an MT#2 tapered fit.

## Items Needed

	Qty
Leather Glove/Clean Rag .....	1
Knockout Tool.....	1

## Installing Headstock Center

1. DISCONNECT MACHINE FROM POWER!
2. Make sure mating surfaces of center and spindle are free of debris and oily substances before inserting center to ensure a good fit and reduce runout.
3. Insert tapered end of center into spindle, and push it in with a quick, firm motion, as shown in **Figure 20**.

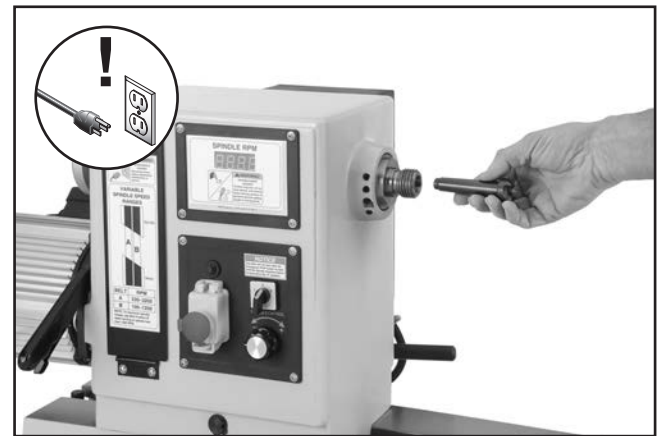

**Figure 20.** Example of installing center in headstock spindle.

4. Make sure center is securely installed by attempting to pull it out by hand—a properly installed center will not pull out easily.





## Removing Headstock Center

1. DISCONNECT MACHINE FROM POWER!
2. Hold a clean rag under spindle or wear leather glove to catch center when you remove it.
3. Insert knockout tool through outbound end of spindle and firmly tap back of center, catching it as it falls, as shown in **Figure 21**.

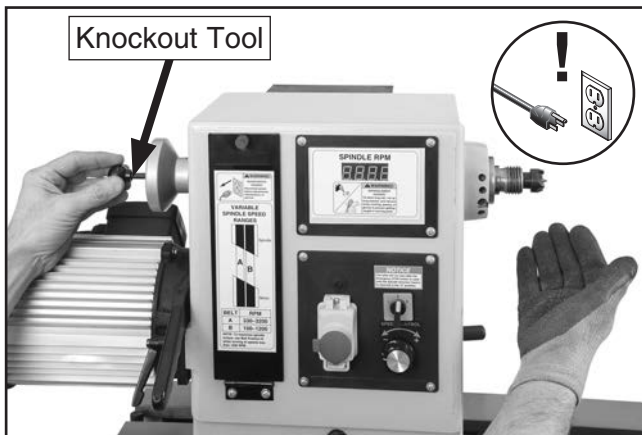

**Figure 21.** Example of removing headstock center with knock-out tool.

## Installing/Removing Tailstock Center

The included live center installs into the tailstock quill with an MT#2 tapered fit.

Item Needed	Qty
Leather Glove/Clean Rag .....	1

### Installing Tailstock Center

1. Loosen quill lock handle, and rotate handwheel until quill extends about 1", as shown in **Figure 22**.

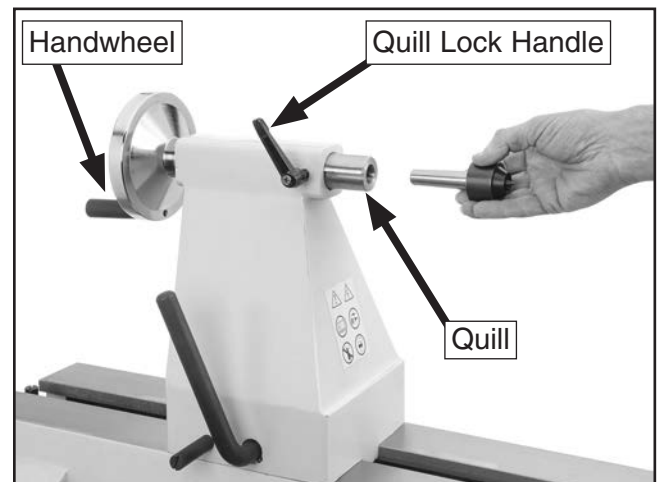
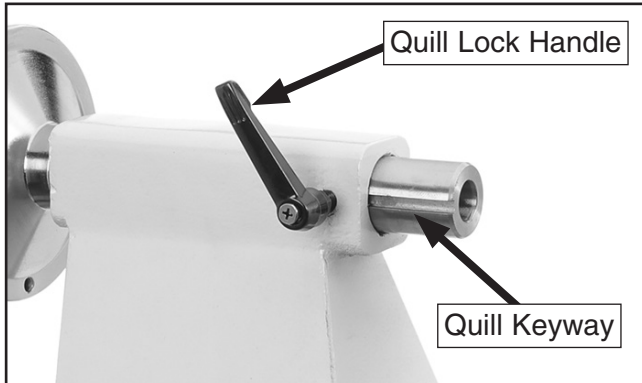

**Figure 22.** Example of installing center into tailstock quill.

2. Make sure mating surfaces of center and quill are free of debris and oily substances before inserting center to ensure a good fit and reduce runout.
3. Firmly insert tapered end of center into tailstock quill, as shown in **Figure 22**.
4. Make sure center is securely installed by attempting to pull it out by hand—a properly installed center will not pull out easily.



5. Make sure center of quill lock handle is aligned with quill keyway to ensure tailstock center and quill will not freely rotate under load (see **Figure 23**).



**Figure 23.** Quill lock handle aligned with quill keyway (center not shown for clarity).

6. Secure quill in place by retightening quill lock handle.

### Removing Tailstock Center

1. Loosen quill lock handle.
2. Hold a clean rag under spindle or wear a glove to catch center when you remove it.
3. Rotate handwheel counterclockwise—tailstock quill will retract back into quill, causing center to be forced out.

## **!WARNING**

Tailstock quill must always be locked in place during lathe operation. Before tightening quill lock handle, it must be properly aligned with quill keyway. Otherwise, workpiece can be thrown from lathe causing serious personal injury or death.

# Installing Faceplate

These instructions cover removing and installing the faceplate. To mount a workpiece to your faceplate, refer to **Faceplate Turning** on **Page 29**.

<b>Tools Needed</b>	<b>Qty</b>
Indexing Pin.....	1
Hex Wrench 3mm.....	1
Knockout Tool.....	1

### Removing Faceplate

1. DISCONNECT MACHINE FROM POWER!
2. Insert included indexing pin into an indexing hole (see **Figure 24**) and rotate spindle until pin engages, preventing spindle from turning.
3. Loosen (2) set screws on faceplate (see **Figure 24**).

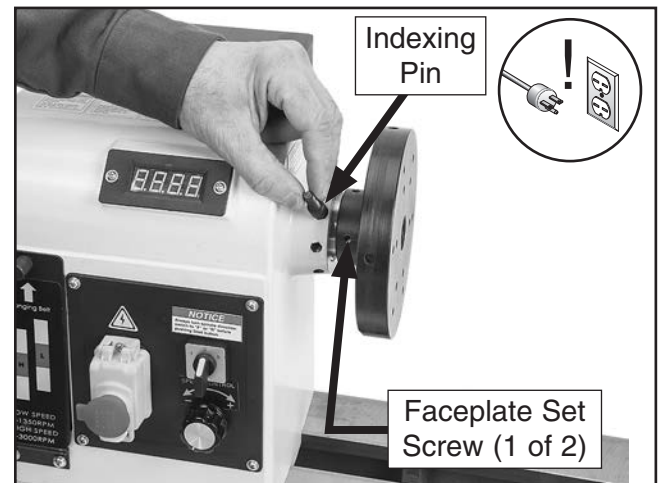

**Figure 24.** Inserting indexing pin.



- Turn faceplate counterclockwise (see **Figure 25**) until it is removed. If the spur center is installed, it will be removed during this process.

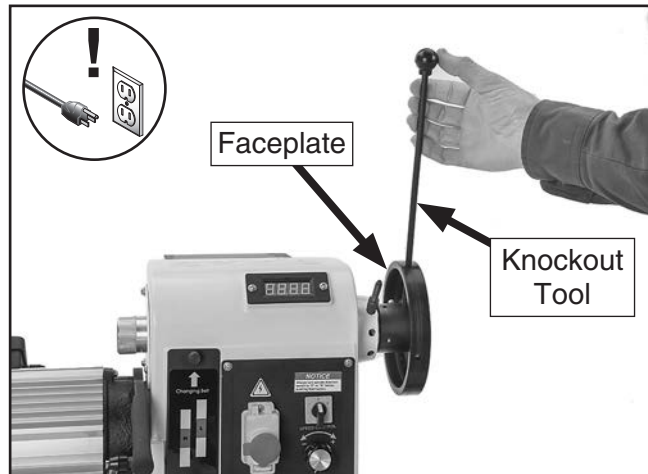

**Figure 25.** Removing faceplate.

### Installing Faceplate

- DISCONNECT MACHINE FROM POWER!
- Insert included indexing pin into an indexing hole (see **Figure 24**) and rotate spindle until pin engages to prevent spindle from turning.
- Thread faceplate clockwise onto spindle shaft until secure against shoulder on spindle shaft.
- Tighten/secure (2) set screws on faceplate (see **Figure 24** on **Page 24**).

### **!WARNING**

To prevent faceplate and workpiece separating from spindle during operation, headstock faceplate **MUST** be firmly threaded onto spindle and secured in place by fully tightening the two faceplate set screws. If these instructions are not properly performed, serious personal injury could occur.

### **!CAUTION**

Never resume turning operations without making sure that index pin knob is disengaged and spindle turns freely by hand. Otherwise personal injury or property damage could result.

## Changing Speed Ranges

Your lathe has two speed ranges for maximum turning options. These ranges are selected by changing belt positions on the motor and spindle pulleys (see **Figure 26**).

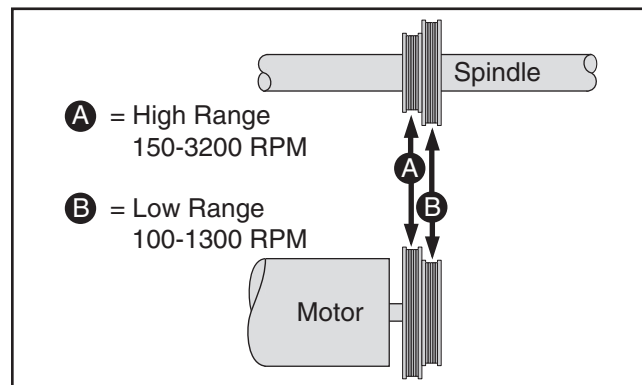

**Figure 26.** Speed range belt positions.

High range (**A**) is best when turning a workpiece where a clean finish is required and only light cuts are made. Low range (**B**), which has more torque, is best when turning a workpiece where a lot of material must be removed and a rough finish does not matter. Use low range for spindle speeds of 1300 RPM or less. Use the speed dial to adjust spindle speed within each range.

Refer to the chart below to choose the appropriate RPM for your operation. Then choose the speed range that will include the selected RPM.

Diameter of Work-piece	Roughing RPM	General Cutting RPM	Finishing RPM
Under 2"	1520	3200	3200
2-4"	760	1600	2480
4-6"	510	1080	1650
6-8"	380	810	1240
8-10"	300	650	1000
10-12"	255	540	830
12-14"	220	460	710
14-16"	190	400	620

**Figure 27.** Model G0838 speed recommendations.



# **!WARNING**

Always choose correct spindle speed for an operation. Using wrong speed may lead to workpiece being thrown at high speed, causing severe or fatal impact injuries.

To change speed ranges:

1. DISCONNECT MACHINE FROM POWER!
2. Open front belt access cover, as shown in **Figure 28**.

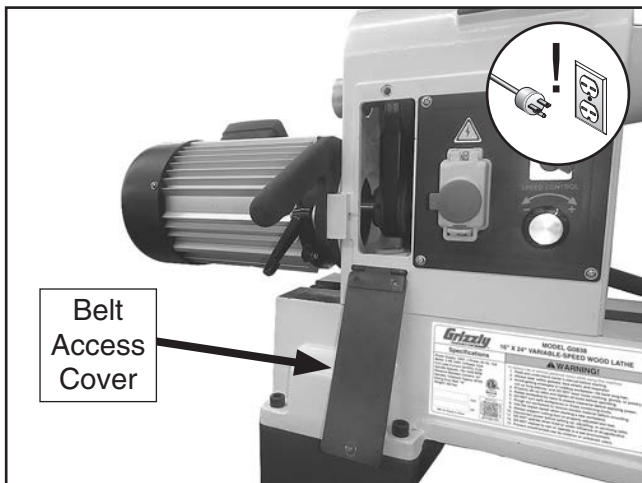

**Figure 28.** Belt access cover opened.

3. Loosen belt-tension lock handle (see **Figure 29**).
4. Use belt-tension lever (see **Figure 29**) to lift motor assembly all the way up, then re-tighten belt-tension lock handle—this will hold motor in place while you change belt position.

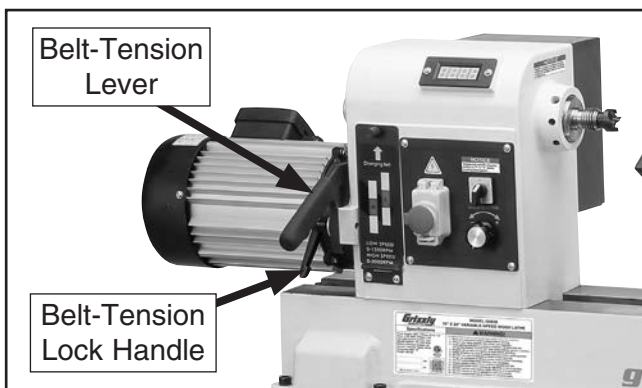

**Figure 29.** Motor tensioning handle and tension lock handle.

5. Reach into belt access cavity and roll belt onto desired set of pulleys, as shown in **Figure 30**.

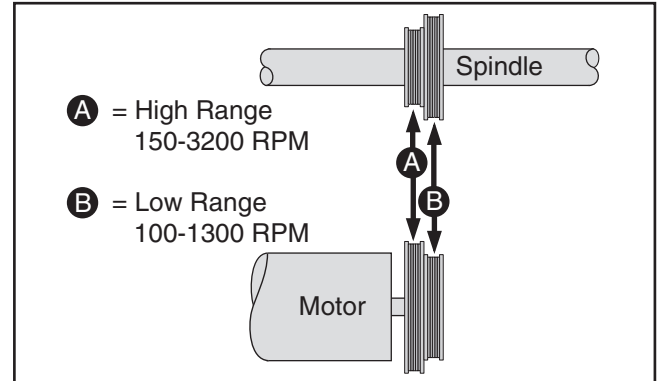

**Figure 30.** Speed range belt positions.

6. Loosen belt-tension lock handle and lower motor.
7. Apply downward pressure on belt-tension lever to properly tension drive belt, then tighten belt-tension lock handle.

**Note:** When properly tensioned, belt should deflect about  $\frac{1}{8}$ " when moderate pressure is applied to belt mid-way between upper and lower pulley, as shown in **Figure 31**.

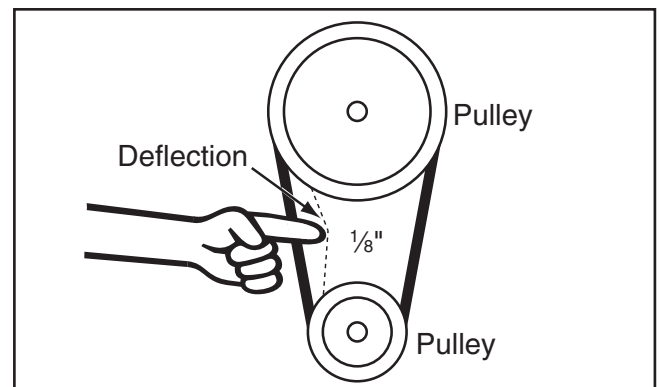

**Figure 31.** Testing for  $\frac{1}{8}$ " belt deflection.

8. Close and secure belt access cover.



# Indexing

## ⚠ CAUTION

Always disconnect lathe from power before using indexing feature. DO NOT start lathe with indexing pin inserted into spindle; otherwise entanglement injury and property damage could occur.

Indexing on a lathe is typically used for workpiece layout and other auxiliary operations that require equal distances around the workpiece circumference, such as clock faces or inlays.

By inserting the indexing pin into one of the three outer indexes of the Model G0838 spindle housing and engaging one of the 12 inner indexes in the spindle, the workpiece can be positioned in 30° increments, as shown in Figures 32–33.

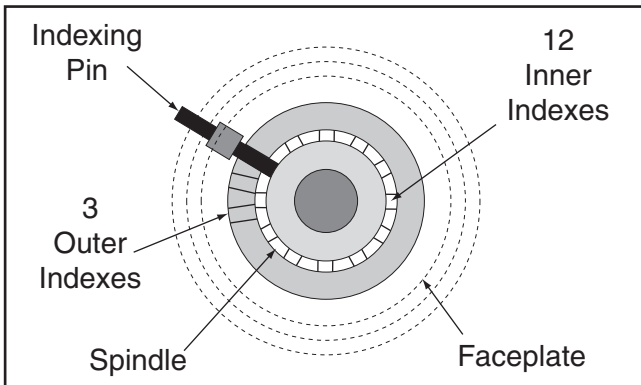

Figure 32. Model G0838 indexing configuration.

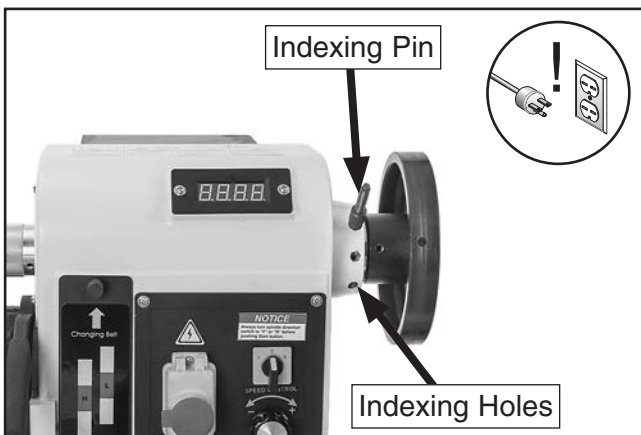

Figure 33. Indexing pin and indexing holes.

# Spindle Turning

Spindle turning is the operation performed when a workpiece is mounted between centers in the headstock and tailstock, as shown in Figure 34. Bowls, table legs, tool handles, and candlesticks are typical projects where this operation is used.

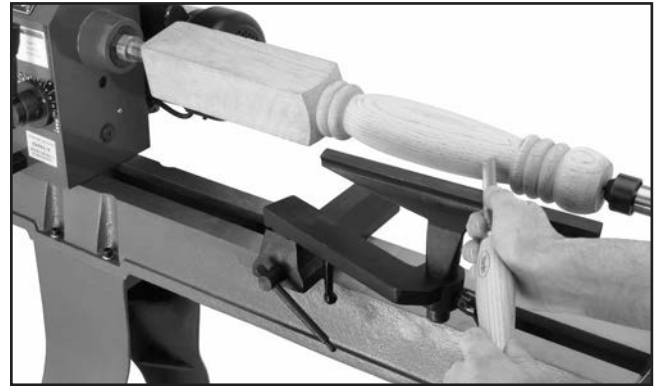

Figure 34. Typical spindle turning operation.

## ⚠ WARNING

Damage to your eyes and lungs could result from using this machine without proper protective gear. Always wear safety glasses, a face shield, and a respirator when operating this machine.

Tools Needed	Qty
Precision Ruler .....	1
Wood Mallet.....	1
Drill Bit 1/4".....	1
Tablesaw/Bandsaw.....	1



### To set up a spindle turning operation:

1. Find center point of both ends of your workpiece by drawing diagonal lines from corner to corner across end of workpiece, as shown in **Figure 35**.

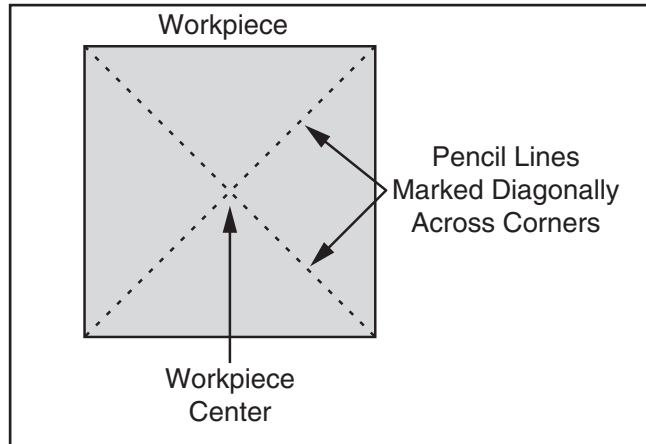

**Figure 35.** Workpiece marked diagonally from corner to corner to determine the center.

2. Make a center mark by using a wood mallet and tapping point of spur center into center of workpiece on both ends.
3. Using a 1/4" drill bit, drill a 1/4" deep hole at center mark on end of the workpiece to be mounted on headstock spur center.
4. To help embed spur center into workpiece, cut 1/8" deep saw kerfs in headstock end of workpiece along diagonal lines marked in **Step 1**.
5. If your workpiece is over 2" x 2", cut corners off workpiece lengthwise to make turning safer and easier (see **Figure 36**).

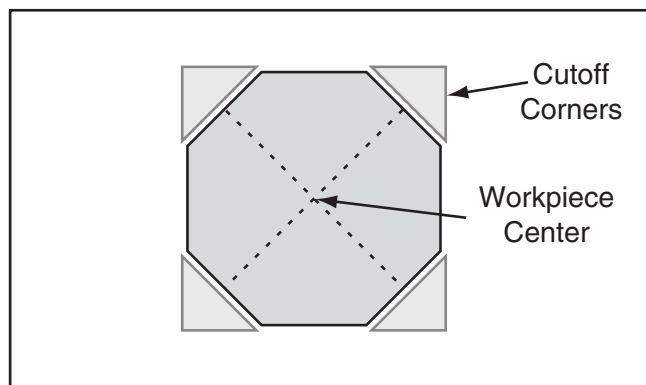

**Figure 36.** Corners of workpiece removed.

6. Drive spur center into end center mark of workpiece with a wood mallet to embed it at least 1/4" into workpiece, as shown in **Figure 37**.

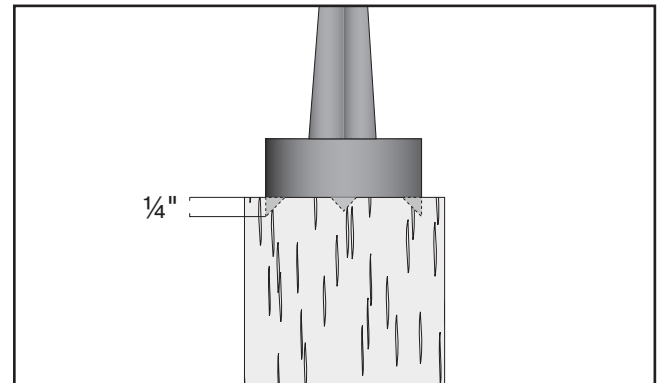

**Figure 37.** Spur center properly embedded.

7. With workpiece still attached, insert spur center into headstock spindle (refer to **Installing/Removing Headstock Center** on **Page 22** for additional instructions).

**Note:** Use tool rest to support opposite end of workpiece so that workpiece and spur center do not separate during installation.

8. Install live center into tailstock quill and tighten quill-lock handle to lock quill in position (refer to **Page 23** for additional instructions).
9. Slide tailstock toward workpiece until point of live center touches workpiece center mark, then lock tailstock in this position.
10. Loosen quill-lock handle and rotate tailstock handwheel to push live center into workpiece at least 1/4".

## **!WARNING**

Do not press the workpiece too firmly with the tailstock or the bearings will bind and overheat. Do not adjust the tailstock too loosely or the workpiece will spin off the lathe. Use good judgment and care, otherwise serious personal injury could result from the workpiece being ejected at high speeds.

11. Properly adjust tool rest to workpiece (see **Adjusting Tool Rest** on **Page 21**).



- Before beginning lathe operation, rotate workpiece by hand to ensure there is safe clearance on all sides.

**!WARNING**

Keep lathe tool resting on tool rest the ENTIRE time it is in contact with workpiece or when preparing to make contact between lathe tool and workpiece. Otherwise, spinning workpiece could force lathe tool out of your hands or entangle your hands with workpiece. Failure to heed this warning could result in serious personal injury.

### Spindle Turning Tips:

- When turning the lathe **ON**, stand away from the path of the spinning workpiece until the spindle reaches full speed and you can verify that the workpiece will not come loose.
- Use the slowest speed when starting or stopping the lathe.
- Select the right speed for the size of workpiece that you are turning (refer to **Figure 27** on **Page 25**).
- Keep the turning tool on the tool rest the ENTIRE time that it is in contact with the workpiece.
- Learn the correct techniques for each tool you will use. If you are unsure about how to use the lathe tools, read books or magazines about lathe techniques, and seek training from experienced and knowledgeable lathe users.

**!WARNING**

Eye injuries or respiratory problems can occur while operating this machine. Wear personal protective equipment to reduce your risk from these hazards.

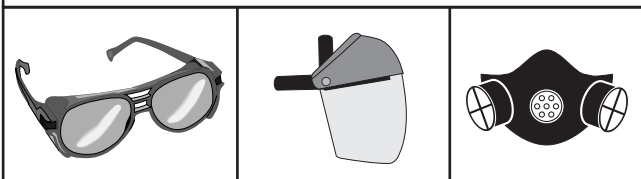

# Faceplate Turning

Faceplate turning is when a workpiece is mounted to the faceplate, which is then mounted to the headstock spindle, as shown in **Figure 38**. This type of turning is usually done with open-faced workpieces like bowls or plates.

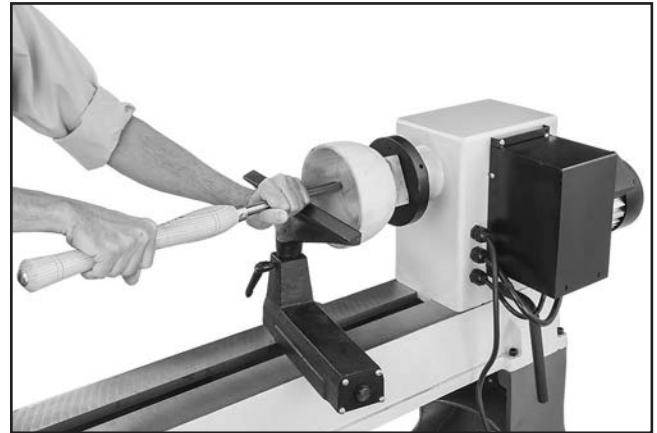

**Figure 38.** Typical faceplate turning operation.

### Mounting Workpiece on Faceplate

Items Needed	Qty
Precision Ruler .....	1
Wood Screws .....	1
Drill .....	1
Tablesaw/Bandsaw.....	1

#### To mount workpiece on faceplate:

- Mark workpiece center in same manner as described in **Spindle Turning** (see **Page 27**).

**Note:** Cut off corners of workpiece to make it as close to "round" as possible, as described in **Spindle Turning, Step 5** (see **Page 28**).



- Center faceplate on workpiece and attach it (see **Figure 39**) with wood screws.

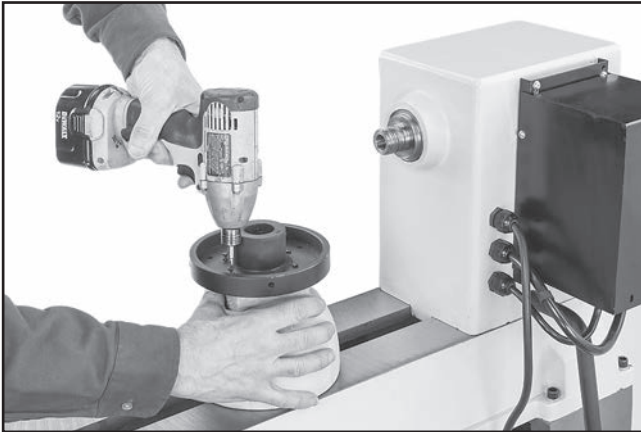

**Figure 39.** Typical attachment of faceplate to workpiece.

## **NOTICE**

**Only use screws with non-tapered heads (see **Figure 40**) to attach faceplate to the workpiece. Screws with tapered heads can split faceplate or snap off during operation.**

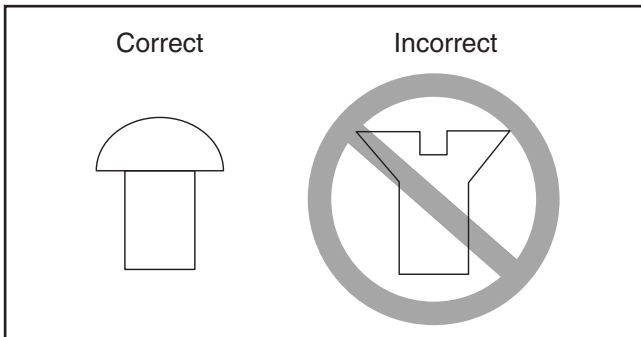

**Figure 40.** Correct and incorrect screw types.

- Thread and secure faceplate onto headstock spindle (refer to **Installing Faceplate** on **Page 24**).

— If wood screws cannot be placed in workpiece, faceplate can be mounted to a backing block attached to workpiece (see **Mounting Workpiece on Backing Block**).

## **Mounting Workpiece on Backing Block**

<b>Items Needed</b>	<b>Qty</b>
Piece of Scrap Wood.....	1
Precision Ruler .....	1
Drill Bit 1/4" .....	1
Glue .....	As Needed
Clamp .....	1

### **To mount workpiece on backing block:**

- Make backing block from a suitable size piece of scrap wood.

**Note:** *Faces of backing block must be flat and parallel with each other, or uneven surfaces will cause workpiece to spin eccentrically, causing unnecessary vibration and runout. It is best to mount backing block to faceplate and turn other surface flat prior to mounting.*

- Locate and mark center of workpiece and backing block.
- Drill a 1/4" hole through center of backing block.
- Look through hole in backing block to line up center with workpiece, and then glue and clamp backing block to workpiece.

**Note:** *Allow glue to cure according to manufacturer's instructions.*

- Follow **Steps 1–3** under **Mounting Workpiece on Faceplate** (see **Page 29**) to attach backing block to faceplate.





# Outboard Turning

Outboard turning is a variation of faceplate turning and is accomplished with the headstock positioned so the faceplate is not directly over the bed, allowing a larger turning capacity than the swing specification of the lathe.

The only way to rotate the headstock on this machine is to remove it from the bed first, which can be a heavy and cumbersome task. A much simpler alternative to removing the headstock is to remove the tailstock and slide the headstock to the other end of the bed. This will position the spindle so it is not directly over the bed whereby outboard turning can safely be accomplished.

## To outboard turn:

1. DISCONNECT MACHINE FROM POWER!
2. Remove tailstock and tool base from machine by removing hex nuts and clamp washers located underneath assemblies, then lifting them from lathe bed.
3. Loosen headstock, then move it all the way to tail end of lathe bed, as shown in **Figure 41**.

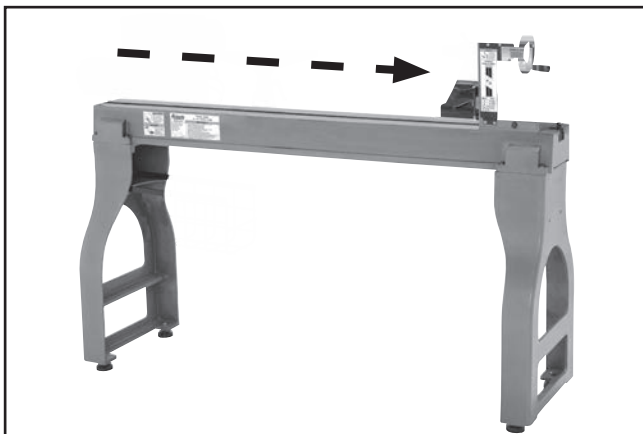

**Figure 41.** Example of lathe prepared for outboard turning.

4. Re-tighten headstock to bed.

## **!**WARNING

When outboard turning, **ALWAYS** use a floor-mounted tool rest and keep tool in contact with rest during all turning operations. Failure to do so could cause tool to be pulled out of operator's control and ejected at high speed.

# Sanding/Finishing

After the turning operations are complete, the workpiece can be sanded and finished before removing it from the lathe, as shown in **Figure 42**.

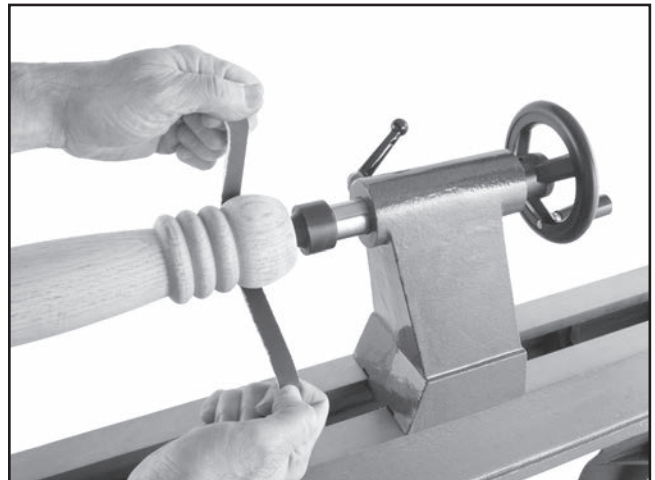

**Figure 42.** Typical sanding operation.

**Note:** Whenever sanding or finishing, move tool rest holder out of the way to increase personal safety and gain adequate working room.

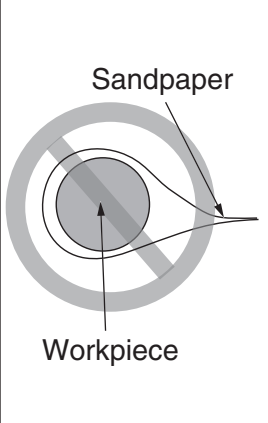
	<h2><b>!</b>WARNING</h2> <p>Wrapping sandpaper completely around workpiece could pull your hands into moving workpiece and may cause serious injury. Never wrap sandpaper or finishing materials completely around workpiece.</p>
--	---



# Selecting Turning Tools

---

Lathe tools come in a variety of shapes and sizes, and usually fall into five major categories.

- **Gouges**—Mainly used for rough cutting, detail cutting, and cove profiles. The rough gouge is a hollow, double-ground tool with a round nose, and the detail gouge is a hollow, double-ground tool with either a round or pointed nose.

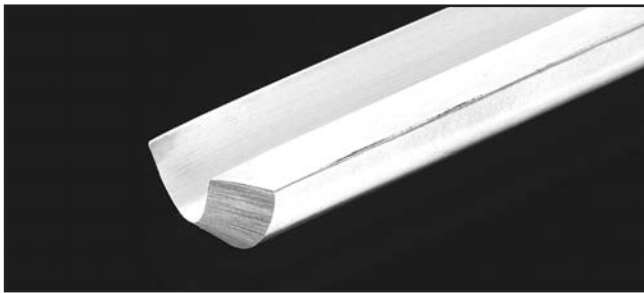

**Figure 43.** Example of a gouge.

- **Skew Chisel**—A very versatile tool that can be used for planing, squaring, V-cutting, beading, and parting off. The skew chisel is flat, double-ground with one side higher than the other (usually at an angle of 20°–40°).

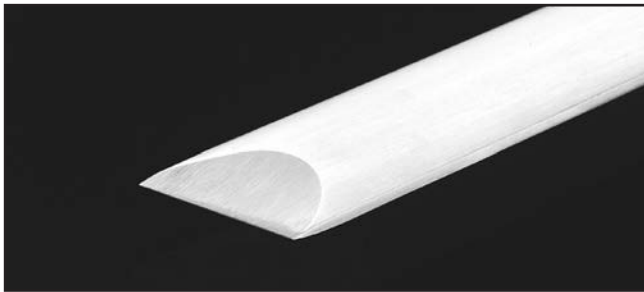

**Figure 44.** Example of a skew chisel.

- **Scrapers**—Typically used where access for other tools is limited, such as hollowing operations. This is a flat, double-ground tool that comes in a variety of profiles (round nose, spear point, square nose, etc.) to match many different contours.



**Figure 45.** Example of a round nose scraper.

- **Parting Tools**—Used for sizing and cutting off work. This is a flat tool with a sharp pointed nose that may be single- or double-ground.

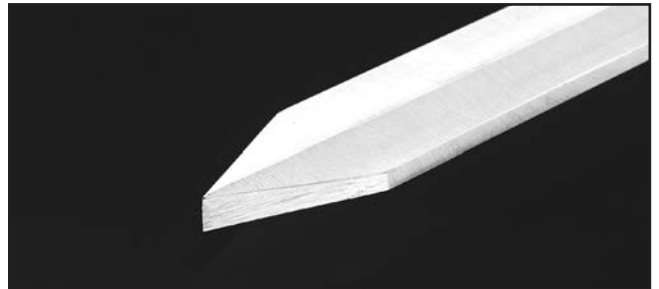

**Figure 46.** Example of a parting tool.

- **Specialty Tools**—These are the unique, special function tools to aid in hollowing, bowl making, cutting profiles, etc. The Swan Neck Hollowing Tool shown on **Page 33** is a good example of a speciality tool.



# SECTION 5: ACCESSORIES

## **! WARNING**

Installing unapproved accessories may cause machine to malfunction, resulting in serious personal injury or machine damage. To reduce this risk, only install accessories recommended for this machine by Grizzly.

## **NOTICE**

Refer to our website or latest catalog for additional recommended accessories.

### **T28372—Bed/Tool Post Extension for G0838**

For increased bowl turning capacity, this Bed & Tool Post Extension kit provides an incredible 28" swing over the bed extension. The extension can also be mounted to the end of the lathe bed for a total of 47" between centers. For use with the G0838 Variable Speed Wood Lathe.



Figure 47. Model T28372 Bed/Tool Post Extension for G0838.

### **D3788—Shop Fox 5-Pc. Lathe Chisel Set**

With massive high speed steel blades and long ash handles, this set includes a 1" roughing gouge,  $\frac{3}{8}$ " straight chisel, swan neck hollowing tool,  $\frac{3}{8}$ " spindle gouge, and  $\frac{1}{8}$ " parting tool. Also includes a fitted aluminum case.

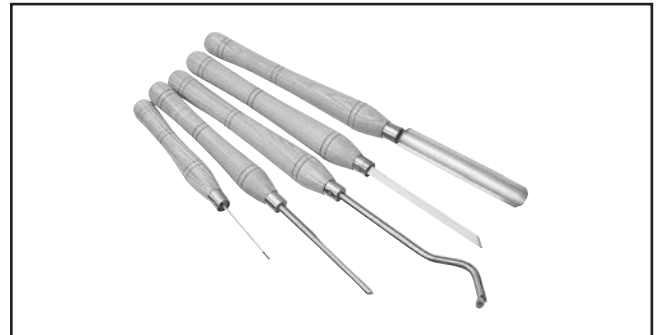

Figure 48. Model D3788 Shop Fox 5-Pc. Chisel Set.

### **Basic Eye Protection**

T20501—Face Shield Crown Protector 4"

T20502—Face Shield Crown Protector 7"

T20503—Face Shield Window

T20451—"Kirova" Clear Safety Glasses

T20452—"Kirova" Anti-Reflective S. Glasses

T20456—DAKURA Safety Glasses, Black/Clear



Figure 49. Assortment of basic eye protection.

**order online at [www.grizzly.com](http://www.grizzly.com) or call 1-800-523-4777**



# SECTION 6: MAINTENANCE

---

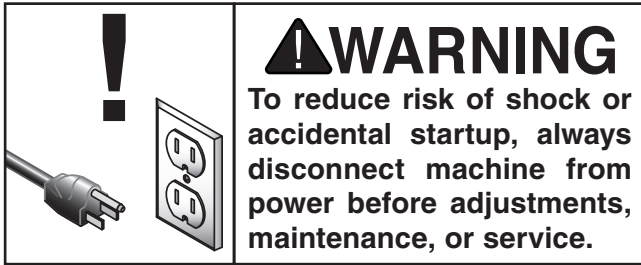

## Schedule

---

For optimum performance from this machine, this maintenance schedule must be strictly followed.

### Ongoing

To maintain a low risk of injury and proper machine operation, if you ever observe any of the items below, shut down the machine immediately and fix the problem before continuing operations:

- Loose faceplate or mounting bolts.
- Damaged center or tooling.
- Worn or damaged wires.
- Loose machine components.
- Any other unsafe condition.

### Daily

- Clean off dust buildup.
- Clean and lubricate lathe bed, spindle, and quill.

### Monthly

- Belt tension, damage, or wear.
- Clean out dust buildup from inside belt/pulley cavity.

## Cleaning & Protecting

---

Cleaning the Model G0838 is relatively easy. Vacuum excess wood chips and sawdust, and wipe off the remaining dust with a dry cloth. If any resin has built up, use a resin-dissolving cleaner to remove it.

Protect the unpainted cast-iron surfaces by wiping them clean after every use—this ensures moisture from wood dust does not remain on bare metal surfaces. Keep the surfaces rust-free with regular applications of products like G96® Gun Treatment, SLIPIT®, or Boeshield® T-9.

## Lubrication

---

All bearings for the Model G0838 are lubricated and sealed at the factory, and do not need additional lubrication.

Wipe a lightly oiled shop rag on the outside of the headstock spindle. DO NOT allow any oil to get on the inside mating surfaces of the spindle.

Use the tailstock handwheel to extend the quill out to the furthest position and apply a thin coat of white lithium grease to the outside of the quill. DO NOT allow any oil or grease to get on the inside mating surfaces of the quill.



# SECTION 7: SERVICE

Review the troubleshooting procedures in this section if a problem develops with your machine. If you need replacement parts or additional help with a procedure, call our Technical Support. **Note:** *Please gather the serial number and manufacture date of your machine before calling.*

## Troubleshooting

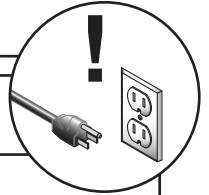

### Motor & Electrical

Symptom	Possible Cause	Possible Solution
Machine does not start, or power-supply fuse/breaker trips immediately after startup.	<ol style="list-style-type: none"> <li>Emergency stop button depressed/at fault.</li> <li>Spindle direction switch in neutral position.</li> <li>Power supply circuit breaker tripped or fuse blown.</li> <li>Motor wires connected incorrectly.</li> <li>Wiring open/has high resistance.</li> <li>ON/OFF switch at fault.</li> <li>Circuit board at fault.</li> <li>Inverter/control box at fault.</li> <li>Variable-speed potentiometer at fault.</li> <li>Motor at fault.</li> </ol>	<ol style="list-style-type: none"> <li>Press side tab in and lift switch cover. Press ON button to reset; replace if not working properly.</li> <li>Toggle switch to forward/reverse.</li> <li>Ensure circuit is sized correctly and free of shorts. Reset circuit breaker or replace fuse.</li> <li>Check/fix broken, disconnected, or corroded wires (<b>Page 40</b>).</li> <li>Check/fix broken, disconnected, or corroded wires.</li> <li>Replace switch/circuit breaker.</li> <li>Inspect/replace if at fault.</li> <li>Inspect inverter/controller box; replace if at fault.</li> <li>Test/replace if at fault.</li> <li>Test/repair/replace.</li> </ol>
Machine stalls or is underpowered.	<ol style="list-style-type: none"> <li>Machine undersized for task.</li> <li>Workpiece material not suitable for machine.</li> <li>Feed rate/cutting speed too fast.</li> <li>Variable-speed potentiometer at fault.</li> <li>Belt slipping.</li> <li>Motor bearings at fault.</li> <li>Pulley slipping on shaft.</li> <li>Motor at fault.</li> </ol>	<ol style="list-style-type: none"> <li>Use sharp chisels; reduce feed rate/depth of cut.</li> <li>Only cut wood/ensure moisture is below 20%.</li> <li>Decrease feed rate/cutting speed (<b>Page 25</b>).</li> <li>Test/replace if at fault.</li> <li>Tension/replace belt; ensure pulleys are aligned (<b>Page 38</b>); belts are clean and not damaged.</li> <li>Test/repair/replace.</li> <li>Tighten/replace loose pulley/shaft.</li> <li>Test/repair/replace.</li> </ol>
Machine has vibration or noisy operation.	<ol style="list-style-type: none"> <li>Motor or component loose.</li> <li>Machine incorrectly mounted/resting on floor.</li> <li>V-belt worn, loose, or misaligned.</li> <li>Pulley loose.</li> <li>Motor fan rubbing on fan cover.</li> <li>Workpiece/faceplate at fault.</li> <li>Motor mount loose/broken.</li> <li>Motor bearings at fault.</li> </ol>	<ol style="list-style-type: none"> <li>Inspect/replace damaged bolts/nuts, and retighten with thread locking fluid.</li> <li>Tighten mounting bolts; relocate/shim machine; adjust feet.</li> <li>Inspect/replace belt (<b>Page 37</b>). Realign pulleys if necessary (<b>Page 38</b>).</li> <li>Realign/replace shaft, pulley, set screw, and key.</li> <li>Fix/replace fan cover; replace loose/damaged fan.</li> <li>Center workpiece in chuck/faceplate; reduce RPM; replace defective chuck.</li> <li>Tighten/replace.</li> <li>Test by rotating shaft; rotational grinding/loose shaft requires bearing replacement.</li> </ol>



## Wood Lathe Operation

Symptom	Possible Cause	Possible Solution
Bad surface finish.	<ol style="list-style-type: none"> <li>1. Dull tooling or wrong tool used for task.</li> <li>2. Tool height is not 1/8" above spindle centerline.</li> <li>3. Spindle speed is wrong.</li> <li>4. Excessive vibration.</li> </ol>	<ol style="list-style-type: none"> <li>1. Sharpen tooling, select correct tool for operation.</li> <li>2. Adjust tool rest so tool is 1/8" above spindle centerline.</li> <li>3. Adjust for appropriate spindle speed (<b>Page 25</b>).</li> <li>4. Troubleshoot possible causes/solutions in this table.</li> </ol>
Excessive vibration upon startup (when workpiece is installed).	<ol style="list-style-type: none"> <li>1. Workpiece is mounted incorrectly.</li> <li>2. Workpiece warped, out of round, or flawed.</li> <li>3. Spindle speed too fast for workpiece.</li> <li>4. Workpiece hitting stationary object.</li> <li>5. Tailstock, or tool rest not securely clamped to lathe bed.</li> <li>6. Belt pulleys are not properly aligned.</li> <li>7. Lathe is resting on an uneven surface.</li> <li>8. Motor mount bolts are loose.</li> <li>9. Belt is worn or damaged.</li> <li>10. Spindle bearings are worn or damaged.</li> </ol>	<ol style="list-style-type: none"> <li>1. Remount workpiece, making sure that centers are embedded in true center of workpiece.</li> <li>2. Cut workpiece to correct, or use a different workpiece.</li> <li>3. Reduce spindle speed (<b>Page 25</b>).</li> <li>4. Stop lathe and fix interference problem.</li> <li>5. Check lock levers and tighten if necessary (<b>Pages 21–22</b>).</li> <li>6. Align belt pulleys (<b>Page 38</b>).</li> <li>7. Shim stand or adjust feet to eliminate wobbles.</li> <li>8. Tighten motor mount bolts.</li> <li>9. Replace belt (<b>Page 37</b>).</li> <li>10. Test by rotating shaft; rotational grinding/loose shaft requires bearing replacement.</li> </ol>
Chisel grabs or digs into workpiece.	<ol style="list-style-type: none"> <li>1. Wrong chisel/tool being used.</li> <li>2. Chisel/tool is too dull.</li> <li>3. Tool rest height not set correctly.</li> <li>4. Tool rest is set too far from workpiece.</li> </ol>	<ol style="list-style-type: none"> <li>1. Use correct chisel/tool.</li> <li>2. Sharpen or replace chisel/tool.</li> <li>3. Correct tool rest height (<b>Page 21</b>).</li> <li>4. Move tool rest closer to workpiece.</li> </ol>
Tailstock moves under load.	<ol style="list-style-type: none"> <li>1. Tailstock mounting bolt/hex nut is loose.</li> <li>2. Bed or clamping surface is excessively oily or greasy.</li> </ol>	<ol style="list-style-type: none"> <li>1. Tighten mounting bolt/hex nut.</li> <li>2. Clean bed or clamping surface to remove excess oil/grease.</li> </ol>
Spindle lacks turning power or starts up slowly.	<ol style="list-style-type: none"> <li>1. Belt is slipping.</li> <li>2. Pulleys loose.</li> <li>3. Workpiece too heavy for spindle.</li> </ol>	<ol style="list-style-type: none"> <li>1. Tighten/adjust belt (<b>Page 37</b>).</li> <li>2. Tighten pulley set screw; re-align/replace shaft, pulley set screw, and key.</li> <li>3. Remove excess material before remounting; use lighter workpiece.</li> </ol>
Quill will not move forward when handwheel is turned	<ol style="list-style-type: none"> <li>1. Keyway is not aligned with quill lock lever.</li> </ol>	<ol style="list-style-type: none"> <li>1. Align quill keyway and quill lock lever and slightly tighten lever to engage keyway.</li> </ol>
DRO doesn't give reading; reading incorrect.	<ol style="list-style-type: none"> <li>1. Shorted/disconnected wiring/plugs.</li> <li>2. Variable-speed potentiometer at fault.</li> <li>3. DRO speed sensor at fault.</li> <li>4. Circuit board at fault.</li> </ol>	<ol style="list-style-type: none"> <li>1. Inspect wiring connections on circuit boards, sensors, and plugs. Replace/repair as necessary.</li> <li>2. Test/replace if at fault.</li> <li>3. Test/replace if at fault.</li> <li>4. Inspect/replace if at fault.</li> </ol>



# Tensioning & Replacing Belt

The drive belt stretches as the lathe is used. Most of the stretching will occur during the first 16 hours, but may continue with further use. If the lathe loses power while making a cut, the belt may be slipping and need tensioning. If the belt shows signs of excessive wear, or damage, replace it.

## Tensioning Belt

1. DISCONNECT MACHINE FROM POWER!
2. Open belt access cover (see **Figure 50**).
3. Loosen belt-tension lock handle, press belt-tension lever down, then tighten belt-tension lock handle (see **Figure 50**).

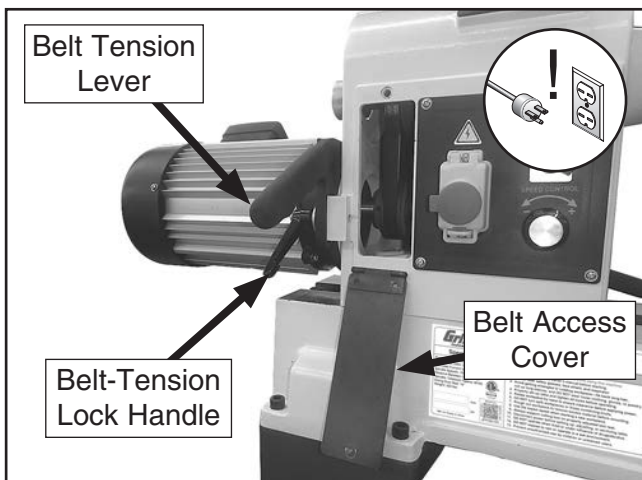

**Figure 50.** Location of belt access cover, belt-tension lock handle, and belt-tension lever.

4. Press belt with moderate pressure in center to check tension. Belt is correctly tensioned when there is approximately  $\frac{1}{8}$ " deflection when pushed as shown in **Figure 51**.

— If there is more than  $\frac{1}{8}$ " deflection repeat the tensioning procedure until it is correct. If tension cannot be achieved replace belt.

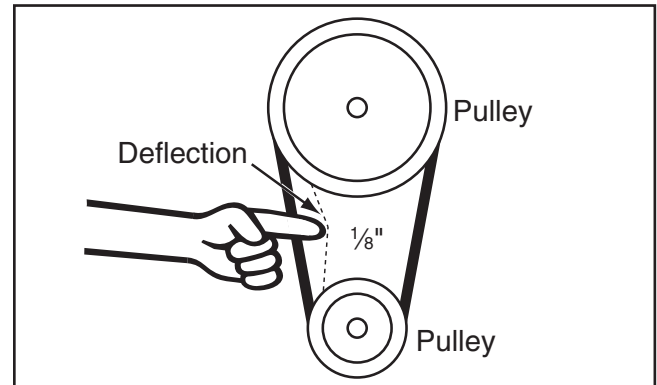

**Figure 51.** Testing for  $\frac{1}{8}$ " belt deflection.

## Replacing Belt

1. DISCONNECT MACHINE FROM POWER!
2. Open front belt access cover (see **Figure 50**).
3. Loosen belt-tension lock handle (see **Figure 50**).
4. Use belt-tension lever (see **Figure 50**) to lift motor assembly all the way up, then re-tighten motor tension lock handle—this will hold motor in place while you change belt position.
5. Reach into belt access cavity and roll belt off motor (lower) pulley, then pull belt off spindle pulley and through front opening.
6. Install new belt by performing **Step 5** in reverse.
7. Loosen belt-tension lock handle, press belt-tension lever down, then tighten belt-tension lock handle (see **Figure 50**).
8. Follow **Step 4** in the **Tensioning Belt** procedure to set belt tension.
9. Close belt access cover.



# Aligning Pulleys

The motor and spindle pulleys are aligned at the factory and should not require any adjustment. If they become misaligned over time, it is important that they be re-aligned in order to extend belt life and maximize the transfer of power from the motor to the spindle.

Tool Needed	Qty
Hex Wrench 3mm.....	1

## To align motor and spindle pulleys:

1. DISCONNECT MACHINE FROM POWER!
2. Open belt access cover.
3. Loosen (2) set screws on motor pulley (see **Figure 52**).

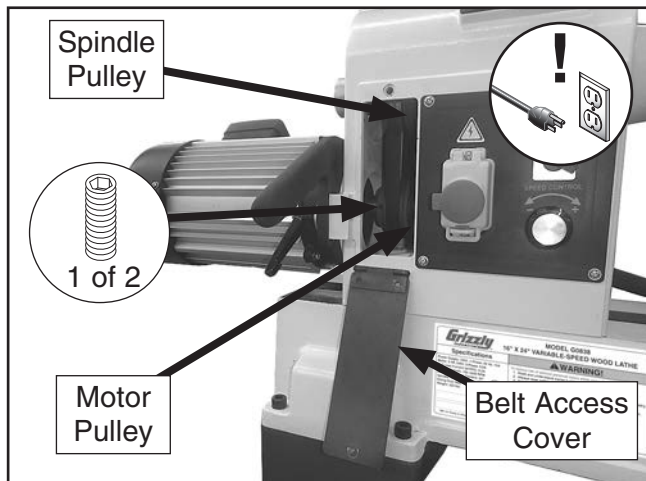

**Figure 52.** Location of spindle pulley and set screws.

4. Slide motor pulley into alignment with spindle pulley.  
**Note:** *When pulleys are properly aligned, there should be no unusual or pulsing sounds coming from the belt.*
5. Tighten set screws and close belt access cover.





# SECTION 8: WIRING

These pages are current at the time of printing. However, in the spirit of improvement, we may make changes to the electrical systems of future machines. Compare the manufacture date of your machine to the one stated in this manual, and study this section carefully.

If there are differences between your machine and what is shown in this section, call Technical Support at (570) 546-9663 for assistance BEFORE making any changes to the wiring on your machine. An updated wiring diagram may be available. **Note:** *Please gather the serial number and manufacture date of your machine before calling. This information can be found on the main machine label.*

## WARNING

### Wiring Safety Instructions

**SHOCK HAZARD.** Working on wiring that is connected to a power source is extremely dangerous. Touching electrified parts will result in personal injury including but not limited to severe burns, electrocution, or death. Disconnect the power from the machine before servicing electrical components!

**MODIFICATIONS.** Modifying the wiring beyond what is shown in the diagram may lead to unpredictable results, including serious injury or fire. This includes the installation of unapproved after-market parts.

**WIRE CONNECTIONS.** All connections must be tight to prevent wires from loosening during machine operation. Double-check all wires disconnected or connected during any wiring task to ensure tight connections.

**CIRCUIT REQUIREMENTS.** You MUST follow the requirements at the beginning of this manual when connecting your machine to a power source.

**WIRE/COMPONENT DAMAGE.** Damaged wires or components increase the risk of serious personal injury, fire, or machine damage. If you notice that any wires or components are damaged while performing a wiring task, replace those wires or components.

**MOTOR WIRING.** The motor wiring shown in these diagrams is current at the time of printing but may not match your machine. If you find this to be the case, use the wiring diagram inside the motor junction box.















**CAPACITORS/INVERTERS.** Some capacitors and power inverters store an electrical charge for up to 10 minutes after being disconnected from the power source. To reduce the risk of being shocked, wait at least this long before working on capacitors.

**EXPERIENCING DIFFICULTIES.** If you are experiencing difficulties understanding the information included in this section, contact our Technical Support at (570) 546-9663.

#### NOTICE

The photos and diagrams included in this section are best viewed in color. You can view these pages in color at [www.grizzly.com](http://www.grizzly.com).

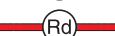
#### COLOR KEY

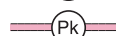
BLACK		BLUE		YELLOW		LIGHT BLUE	
WHITE		BROWN		YELLOW GREEN		BLUE WHITE	
GREEN		GRAY		PURPLE		TURQUOISE	
RED		ORANGE		PINK			



# Wiring Diagram

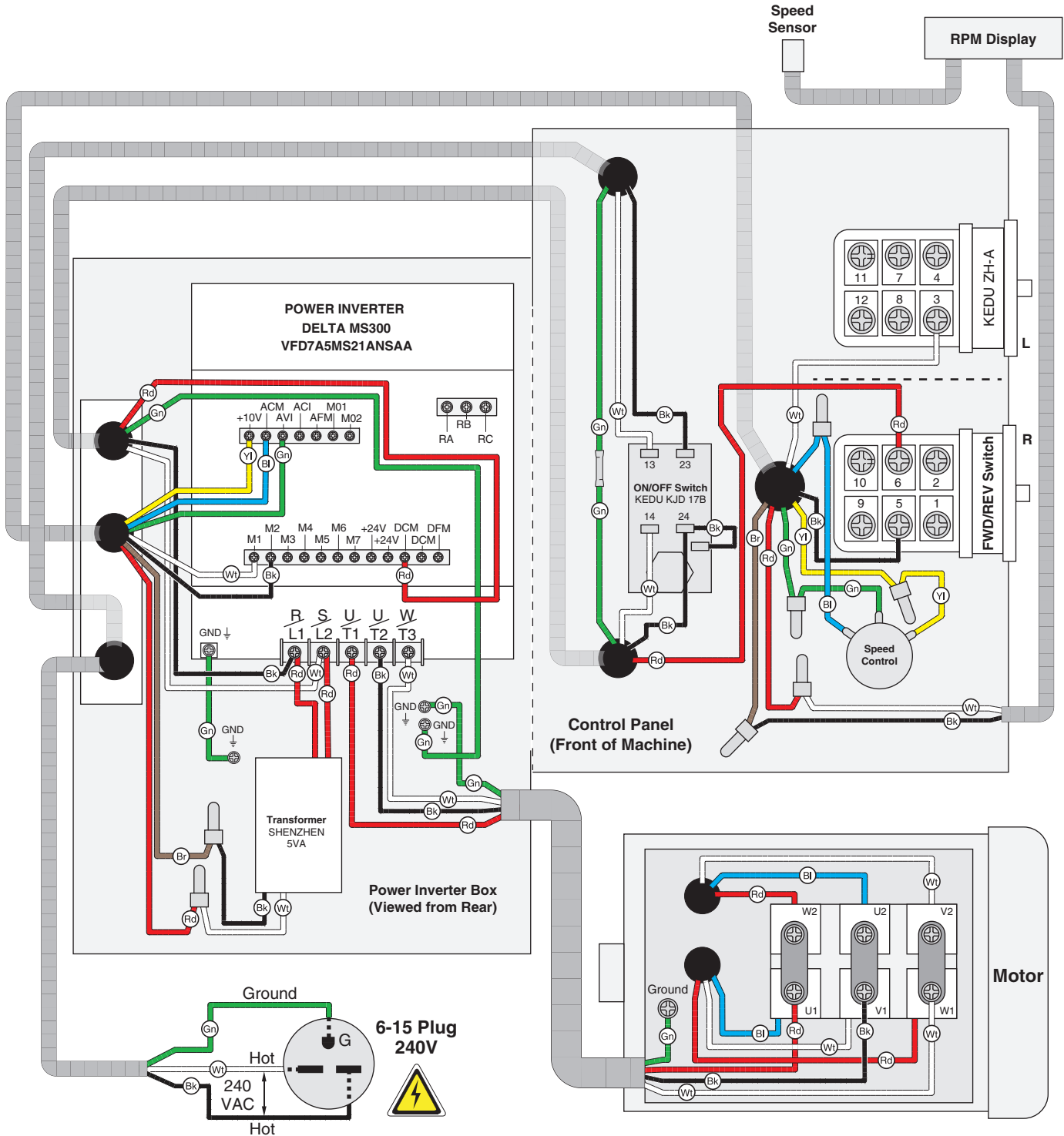

# Wiring Components



Figure 53. Inverter box and motor junction box locations.

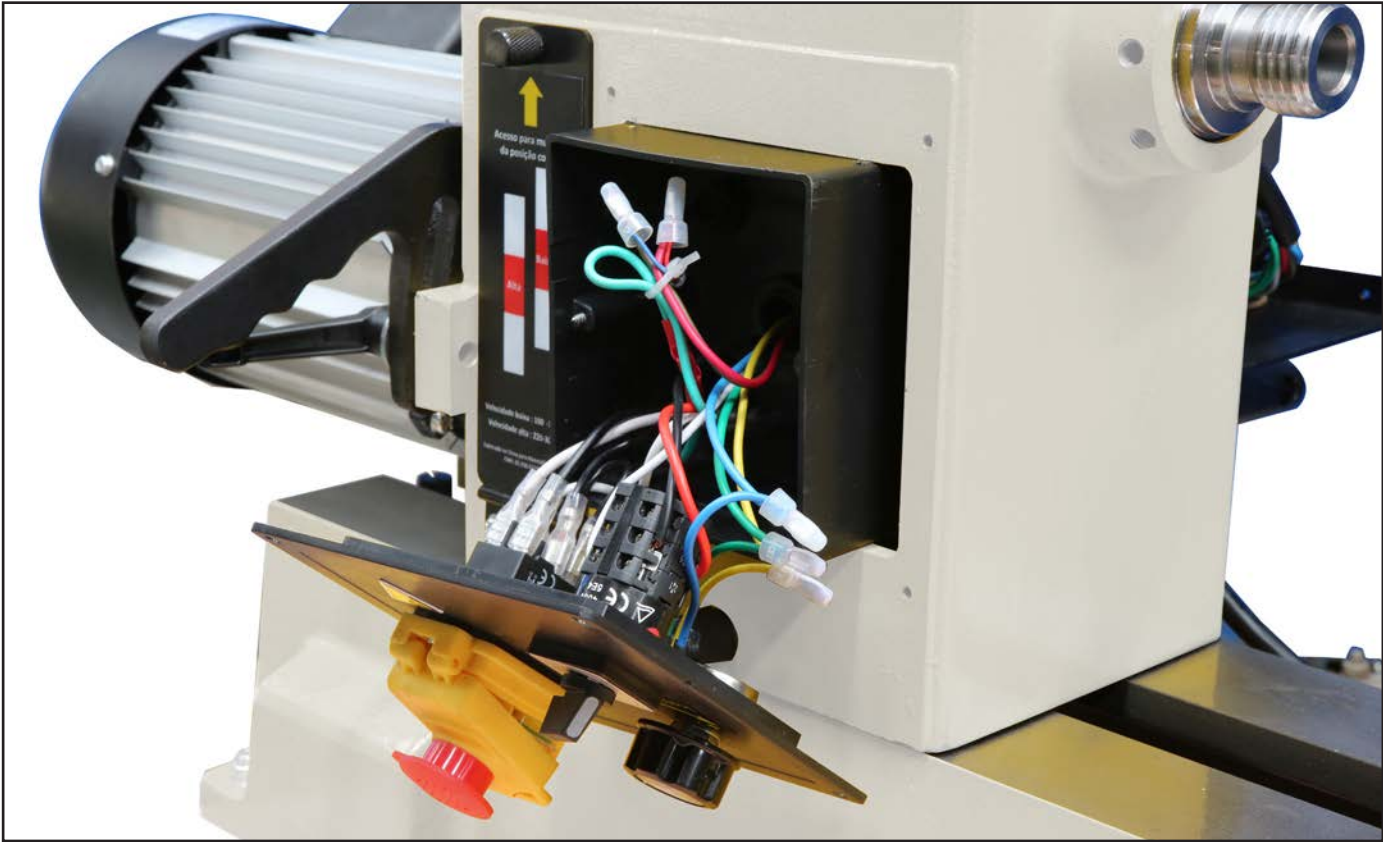
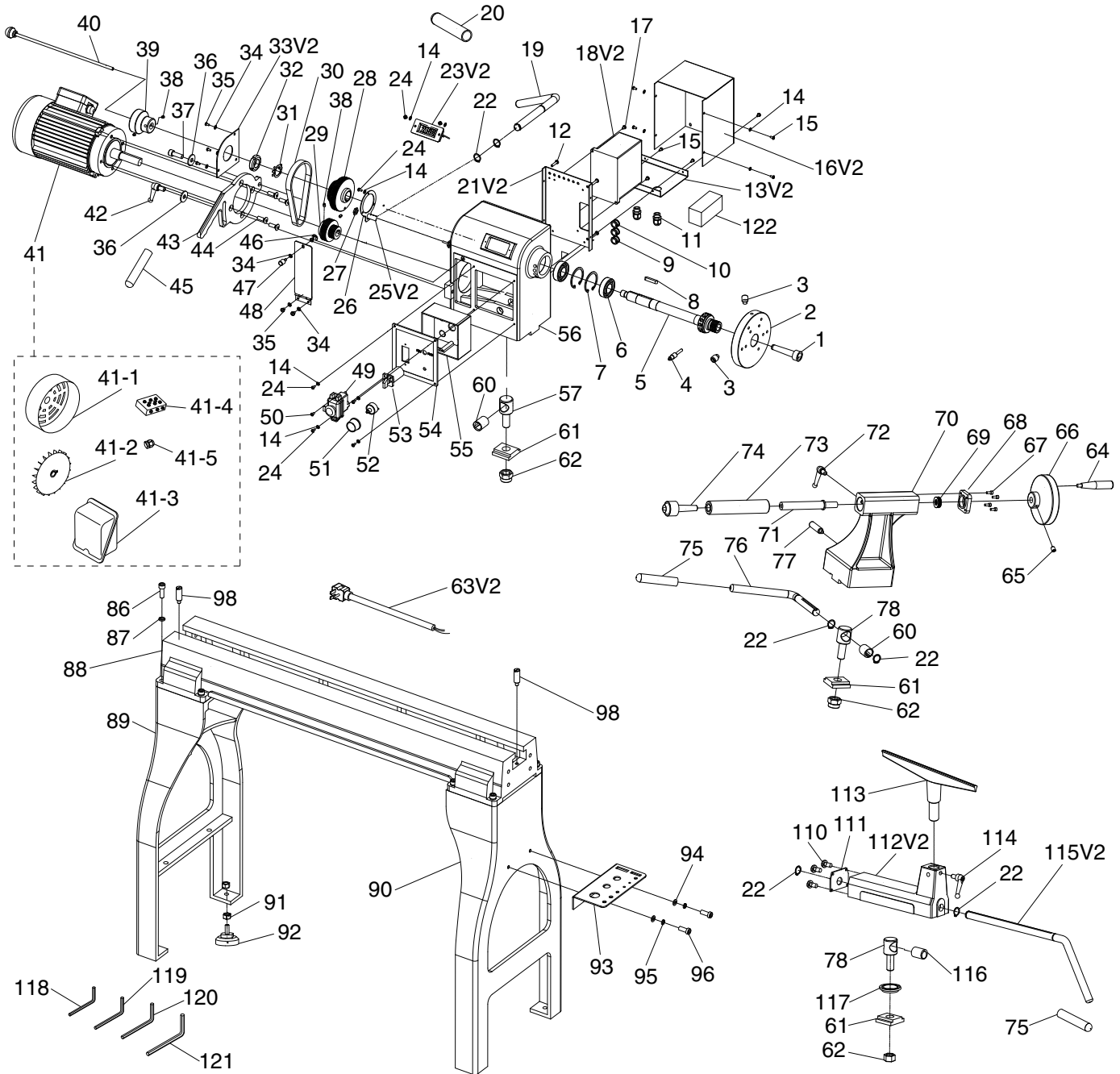

Figure 54. RPM readout display board and control panel wiring.

# SECTION 9: PARTS

We do our best to stock replacement parts when possible, but we cannot guarantee that all parts shown are available for purchase. Call (800) 523-4777 or visit [www.grizzly.com/parts](http://www.grizzly.com/parts) to check for availability.

## Main



# Main Parts List

REF	PART #	DESCRIPTION	REF	PART #	DESCRIPTION
1	P0838001	SPUR CENTER MT 2	49	P0838049	ON/OFF SWITCH KEDU KJD17B
2	P0838002	FACE PLATE 6"	50	P0838050	TAP SCREW M4 X 12
3	P0838003	SET SCREW M6-1 X 12	51	P0838051	VARIABLE SPEED DIAL
4	P0838004	INDEXING PIN	52	P0838052	POTENTIOMETER 1605 WX110010 10K
5	P0838005	SPINDLE	53	P0838053	ROTARY SWITCH KEDU ZH-A
6	P0838006	BALL BEARING 6205-2RS	54	P0838054	PANEL COVER
7	P0838007	INT RETAINING RING 52MM	55	P0838055	SWITCH BOX
8	P0838008	KEY 8 X 8 X 40	56	P0838056	HEADSTOCK CASTING
9	P0838009	RUBBER GROMMET	57	P0838057	HEADSTOCK CLAMP BOLT
10	P0838010	RUBBER GROMMET	60	P0838060	BUSHING
11	P0838011	RUBBER GROMMET	61	P0838061	HEADSTOCK CLAMP
12	P0838012	PHLP HD SCR M5-.8 X 25	62	P0838062	HEX NUT M18-2.5
13V2	P0838013V2	WIRE PLATE V2.05.19	63V2	P0838063V2	POWER CORD 14G 3W 72" 6-15P 90-DEG V2
14	P0838014	FLAT WASHER 4MM	64	P0838064	REV HANDWHEEL HANDLE M8-1.25 X 12
15	P0838015	PHLP HD SCR M4-.7 X 6	65	P0838065	SET SCREW M8-1.25 X 12
16V2	P0838016V2	POWER INVERTER COVER V2.05.19	66	P0838066	HANDWHEEL TYPE-10 140D X 14B-S X M8-1.25
17	P0838017	PHLP HD SCR M4-.7 X 10	67	P0838067	PHLP HD SCR M5-.8 X 14
18V2	P0838018V2	INVERTER DELTA VFD7A5MS21ANSAA V2.05.19	68	P0838068	TAILSTOCK BASE PLATE
19	P0838019	HEADSTOCK LOCK LEVER	69	P0838069	THRUST BEARING 51102
20	P0838020	RUBBER HANDLE TUBE	70	P0838070	TAILSTOCK
21V2	P0838021V2	INVERTER MOUNTING BRACKET V2.05.19	71	P0838071	LEADSCREW
22	P0838022	INT RETAINING RING 19MM	72	P0838072	QUILL LOCK LEVER
23V2	P0838023V2	RPM DIGITAL READOUT V2.05.19	73	P0838073	QUILL
24	P0838024	PHLP HD SCR M4-.7 X 10	74	P0838074	LIVE CENTER MT2
25V2	P0838025V2	RPM SENSOR V2.05.19	75	P0838075	RUBBER HANDLE TUBE
26	P0838026	RPM SENSOR BRACKET	76	P0838076	TAILSTOCK LOCK LEVER
27	P0838027	HEX NUT M12-1.75	77	P0838077	THREADED STUD M8-1.25 X 64
28	P0838028	SPINDLE PULLEY	78	P0838078	TAILSTOCK CLAMP BOLT
29	P0838029	MOTOR PULLEY	86	P0838086	CAP SCREW M10-1.5 X 35
30	P0838030	V-BELT 170J6	87	P0838087	LOCK WASHER 10MM
31	P0838031	SPANNER NUT WASHER 24MM	88	P0838088	BED
32	P0838032	SPANNER NUT M24-2.5 X 1.5	89	P0838089	LEFT STAND LEG
33V2	P0838033V2	SPINDLE PULLEY COVER V2.07.20	90	P0838090	RIGHT STAND LEG
34	P0838034	FLAT WASHER 5MM	91	P0838091	HEX NUT M10-1.5
35	P0838035	PHLP HD SCR M5-.8 X 8	92	P0838092	RUBBER FOOT M10-1.5 X 22
36	P0838036	FENDER WASHER 10MM	93	P0838093	TOOL HOLDER
37	P0838037	CAP SCREW M10-1.5 X 30	94	P0838094	FLAT WASHER 8MM
38	P0838038	SET SCREW M6-1 X 10	95	P0838095	LOCK WASHER 8MM
39	P0838039	SPINDLE HUB	96	P0838096	PHLP HD SCR M8-1.25 X 16
40	P0838040	KNOCKOUT ROD	98	P0838098	BED STOP
41	P0838041	MOTOR 2HP 240V 3-PH	110	P0838110	PHLP HD SCR M5-.8 X 8
41-1	P0838041-1	MOTOR FAN COVER	111	P0838111	SUPPORT PLATE
41-2	P0838041-2	MOTOR FAN	112V2	P0838112V2	TOOL REST BASE V2 05.19
41-3	P0838041-3	MOTOR JUNCTION BOX	113	P0838113	TOOL REST
41-4	P0838041-4	MOTOR TERMINAL	114	P0838114	LOCKING HANDLE M10-1.5 X 18
41-5	P0838041-5	STRAIN RELIEF PG13.5 TYPE-3	115V2	P0838115V2	TOOL REST LOCKING BAR V2 05.19
42	P0838042	BELT TENSION LOCK LEVER M10-1.5 X 26	116	P0838116	TOOL REST ECCENTRIC BUSHING
43	P0838043	BELT TENSION LEVER	117	P0838117	RETAINING PLATE
44	P0838044	FLAT HD CAP SCR M8-1.25 X 20	118	P0838118	HEX WRENCH 3MM
45	P0838045	RUBBER HANDLE TUBE	119	P0838119	HEX WRENCH 4MM
46	P0838046	E-CLIP 4MM	120	P0838120	HEX WRENCH 6MM
47	P0838047	KNURLED THUMB SCREW M5-.8 X 12, 27L	121	P0838121	HEX WRENCH 8MM
48	P0838048	BELT DOOR	122	P0838122	TRANSFORMER SHENZHEN 5VA 90/260V-12V



# Labels & Cosmetics

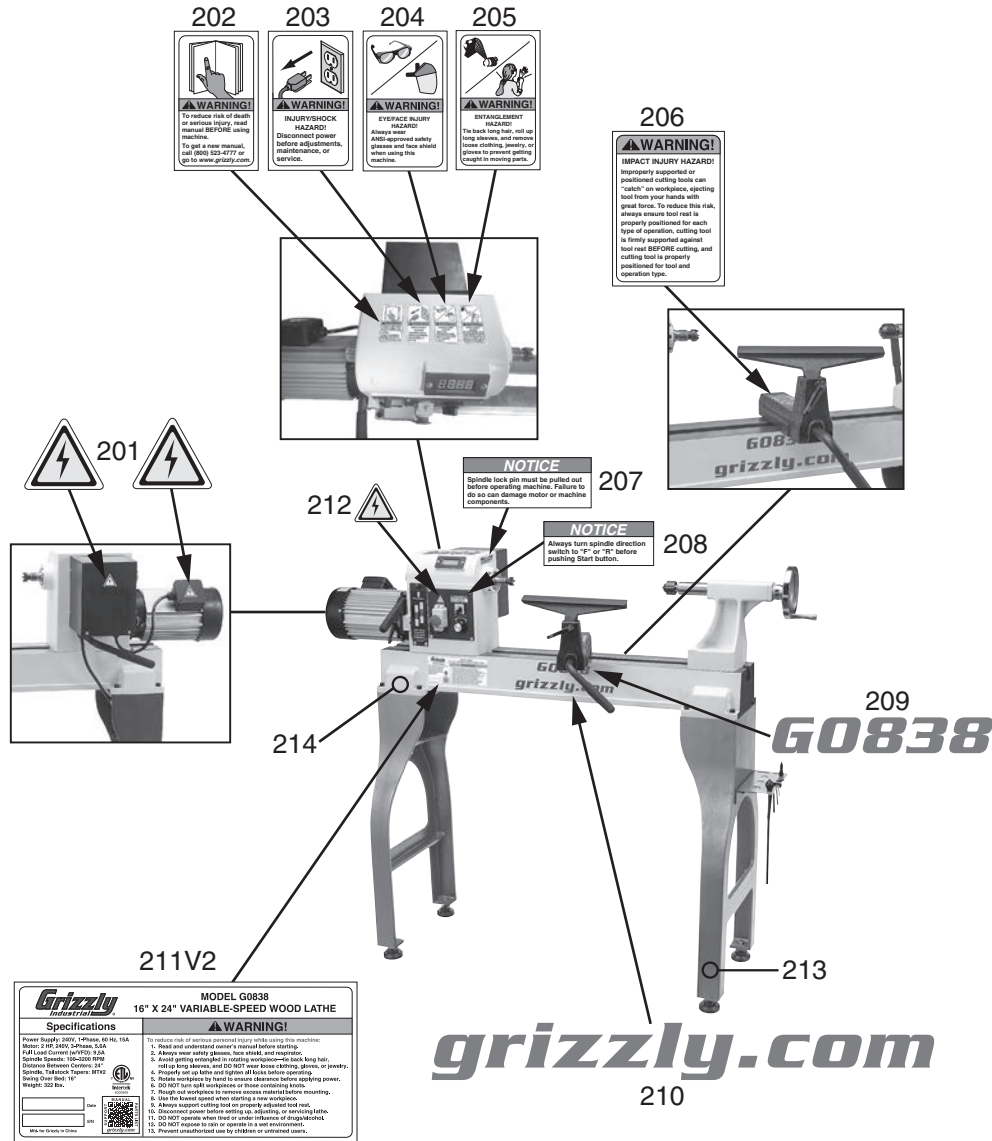

REF	PART #	DESCRIPTION
201	P0838201	ELECTRICAL LABEL
202	P0838202	READ MANUAL WARNING
203	P0838203	INJURY/SHOCK HAZARD
204	P0838204	EYE/FACE INJURY HAZARD
205	P0838205	ENTANGLEMENT HAZARD
206	P0838206	IMPACT INJURY HAZARD
207	P0838207	NOTICE LABEL

REF	PART #	DESCRIPTION
208	P0838208	NOTICE LABEL
209	P0838209	MODEL NUMBER LABEL
210	P0838210	GRIZZLY.COM LABEL
211V2	P0838211V2	MACHINE ID LABEL V2.01.20
212	P0838212	ELECTRICAL LABEL
213	P0838213	TOUCH-UP PAINT, GRIZZLY GREEN
214	P0838214	TOUCH-UP PAINT, GRIZZLY PUTTY

**⚠ WARNING**

Safety labels help reduce the risk of serious injury caused by machine hazards. If any label comes off or becomes unreadable, the owner of this machine **MUST** replace it in the original location before resuming operations. For replacements, contact (800) 523-4777 or [www.grizzly.com](http://www.grizzly.com).



# WARRANTY & RETURNS

---

Grizzly Industrial, Inc. warrants every product it sells for a period of **1 year** to the original purchaser from the date of purchase. This warranty does not apply to defects due directly or indirectly to misuse, abuse, negligence, accidents, repairs or alterations or lack of maintenance. This is Grizzly's sole written warranty and any and all warranties that may be implied by law, including any merchantability or fitness, for any particular purpose, are hereby limited to the duration of this written warranty. We do not warrant or represent that the merchandise complies with the provisions of any law or acts unless the manufacturer so warrants. In no event shall Grizzly's liability under this warranty exceed the purchase price paid for the product and any legal actions brought against Grizzly shall be tried in the State of Washington, County of Whatcom.

We shall in no event be liable for death, injuries to persons or property or for incidental, contingent, special, or consequential damages arising from the use of our products.

The manufacturers reserve the right to change specifications at any time because they constantly strive to achieve better quality equipment. We make every effort to ensure that our products meet high quality and durability standards and we hope you never need to use this warranty.

In the event you need to use this warranty, contact us by mail or phone and give us all the details. We will then issue you a "Return Number," which must be clearly posted on the outside as well as the inside of the carton. We will not accept any item back without this number. Proof of purchase must accompany the merchandise.

Please feel free to write or call us if you have any questions about the machine or the manual.

Thank you again for your business and continued support. We hope to serve you again soon.

To take advantage of this warranty, you must register it at <https://www.grizzly.com/forms/warranty>, or you can scan the QR code below to be automatically directed to our warranty registration page. Enter all applicable information for the product.



***grizzly.com***<sup>®</sup>  
**TOOL WEBSITE**

**Buy Direct and Save with Grizzly<sup>®</sup> – Trusted, Proven and a Great Value!**  
***~Since 1983~***

***Visit Our Website Today For  
Current Specials!***

**ORDER  
24 HOURS A DAY!  
1-800-523-4777**

