

**KestrelMet® 6000**

Wi-Fi Weather Station

# Instruction Manual



[www.kestrelmet.com](http://www.kestrelmet.com)

# NK

## Nielsen-Kellerman (NK) Family of Weather Brands

---

### Weather Monitoring Solutions For Your Profession or Passion

**When the elements can affect the outcome—  
accuracy and accessibility are all that matter.**

NK understands that you depend on accurate measurements to understand changing environmental conditions. The need for immediate and accurate weather data from monitoring devices that simply work is vital to taking action. Because knowing your conditions means making the right decision.



ambient weather



**Kestrel**<sup>®</sup>  
Instruments



**KestrelMet**



**AWN**

AMBIENT  
WEATHER  
NETWORK™

# Contents

## Getting to Know Your KestrelMet 6000

Components & Hardware ..... 5–6

Introduction ..... 7

## Getting Started with Your Weather Station

Station Siting & Setup ..... 9

Unboxing ..... 10

## Set Up & Installation

Assembling the Weather Station ..... 11–14

Connecting to Wi-Fi ..... 15–16

Registering Your Station ..... 17

Mounting ..... 18–19

Powering Up ..... 20

## Product Safety & Information

Troubleshooting ..... 21–23

Specifications ..... 24–26

Product Safety ..... 27

Compliance ..... 28–31

Proposition 65 Warning ..... 32

Warranty ..... 33

Appendix 1: Tripod Mount ..... 35

Appendix 2: Mono Mount ..... 36

Appendix 3: Optional AG sensors ..... 37

AG Sensors Station setup ..... 38–39

Soil sensor array probe placement ..... 40

Manuals and websites ..... 41–42

Find additional product information, FAQs, technical support, instructional videos and more at [AmbientWeather.net/Support](https://AmbientWeather.net/Support)

# Getting to Know Your KestrelMet 6000

## Components & Hardware:



*Vane Anemometer*



*Rain Gauge*



*PV Power Panel*



*Anemometer Mast Extension*



*Bird Guard*



*Station Base Assembly*



*LED Status Light*

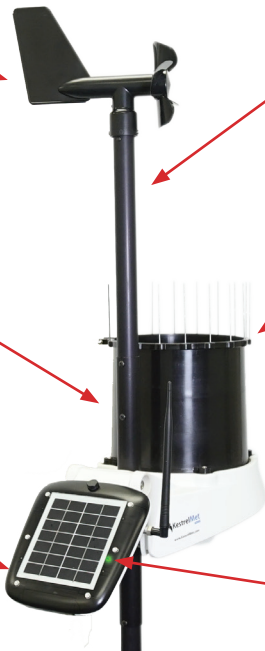

## Components & Hardware (continued):

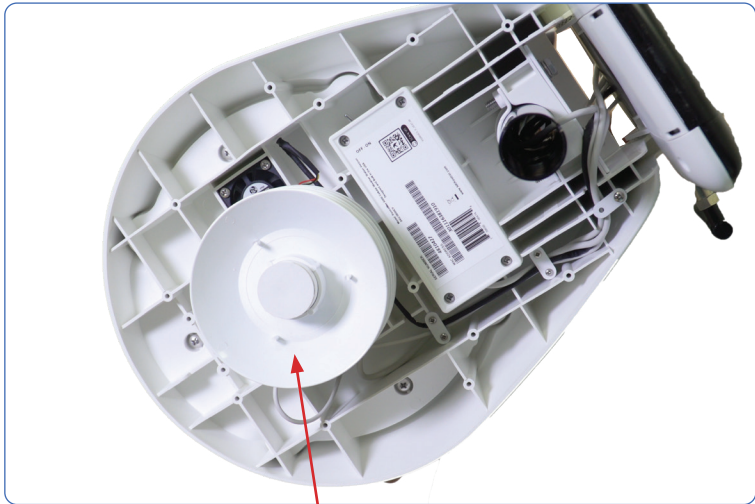

*Aspirated Temperature  
and Humidity Sensors*

# Introduction

You are minutes away from the ability to monitor weather with professional-grade accuracy anywhere, for any personal or professional reason.

The KestrelMet 6000 Wi-Fi Weather Station delivers accurate, hyper-local weather information. It is lightweight, durable, easy to set up and quick to connect.

Your KestrelMet station transports your weather data to a personal dashboard where you can view and share data, view history and graphs, and build reports. Set up your dashboard at [www.AmbientWeather.net](http://www.AmbientWeather.net).

Refer to page 17 of this manual for further instruction.

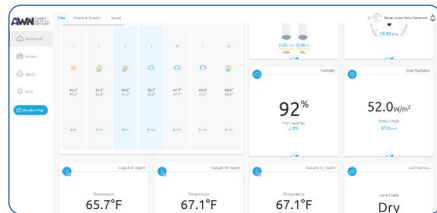

*View your KestrelMet 6000 weather station data at [www.AmbientWeather.net](http://www.AmbientWeather.net) or on the Ambient Weather Network (AWN) app.*

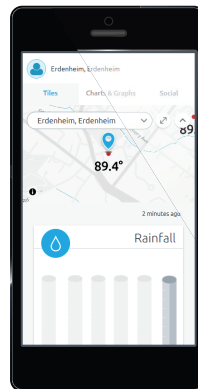

# Getting Started with Your KestrelMet 6000



**IMPORTANT:** Read through these instructions once before starting, and do the steps in the order presented:

1. **Plan your station location and mounting**
2. **Assemble the station**
3. **Turn the station on**
4. **Connect to your Wi-Fi network**
5. **Register the station account**
6. **Mount the station**
7. **View your data on Ambient Weather Network**



 *See appendix 3 for assembly of optional AG sensors*



# 1

## Station Siting and Setup

Where you install your KestrelMet 6000 can positively or negatively impact accuracy. Natural and artificial obstructions around the weather station, like trees or other structures, could skew the data. You can get more detailed station location and siting guidelines at [AmbientWeather.net/support](https://www.AmbientWeather.net/support)

### Location Considerations:

- » Your station requires direct sunlight to maintain the battery charge at a healthy level. Installing the station in a partially shaded location will have an adverse effect on the battery lifetime and may limit the data transmission frequency.
- » Pick a spot you can easily access, as you may have to remove debris from the rain gauge bucket once or twice a year.
- » The station should ideally be mounted at least 5 ft (1.52 meters) above ground and away from roads, buildings and other sources of radiant heat.
- » The station should be well away from trees that could shade the station, block wind or create a natural umbrella.
- » For best results with a roof mount, install the station at the highest point on the roof.
- » The station should be mounted in a location with good Wi-Fi signal strength.

### Mounting Considerations:

- » The rain gauge must be level to provide accurate rainfall measurements. Ensure that your chosen mounting location is sturdy and does not sway in the wind with the additional weight of the station. Excess motion or tilting will greatly reduce the accuracy of rainfall measurements.
- » The assembled station weighs 8.4 lbs, but wind will increase loading on the mount. Mounting hardware is not included with the station.
- » In the Northern Hemisphere, the PV power panel must point south to capture maximum solar energy and for the anemometer to provide accurate wind direction. In the Southern Hemisphere, the panel should point north.

 *More siting and setup information is available at [AmbientWeather.net/support](https://www.AmbientWeather.net/support)*

# 2

## Unboxing

### What's included:

- » Pre-assembled station base; including rain gauge, air temperature, RH and barometric pressure sensors
- » Anemometer mast extension
- » Vane anemometer (wind speed and direction sensors)
- » Bird guard
- » Assembly tools: 5 mm hex key and #2 Phillips tool (Two spare screws included)
- » If you opted to purchase a Mono Mount, your package will include the Mono Mount parts.



Figure A



Figure B

# 3

## Assembling Your Weather Station



**IMPORTANT:** Complete these steps before powering up your station so the sensors initiate correctly.

### Assemble the Anemometer

- » Find the three screws on the anemometer mast extension. Remove and save the small Philips screw at the dimpled end (fig C).



*This screw has a smaller head than the other two.*

- » Loosen the screw closest to the middle of the extension by three turns.
- » The non-dimpled end is marked with red tape. Remove the screw and the tape and save the screw for attaching to the station base (fig D).
- » Pull the anemometer cable out of the station base (fig E), and straighten the cable. Feed the cable into the end that was marked by red tape and continue to push the cable through the anemometer mast extension (fig F) while sliding the extension onto the station base so the connector comes out of the dimpled end (fig G).

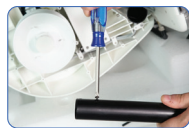

Figure C

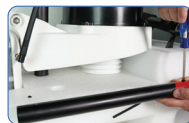

Figure D



Figure E



Figure F



Figure G

# Station Assembly

- » Rotate the anemometer mast extension until the screw aligns with the slot in the station base, then slide the screw all the way into the slot and hand tighten (fig H).
  - » Place the screw that was removed from the non-dimpled end of the mast (fig D) into the hole below the station base slot and hand-tighten it well.
  - » Plug the end of the cable into the anemometer. The red side should be closest to the hub's center and the black side closest to the hubwall (fig I).
  - » Slide the anemometer hub onto the anemometer mast extension with the slot oriented in line with the dimple as shown (fig J).
  - » Replace the screw that was removed from the dimpled end of the mast to secure the anemometer in place and handtighten with a Phillips screwdriver (fig K).
- ✦ *Spare screws are provided in the zip lock bag with the assembly tools.*



Figure H

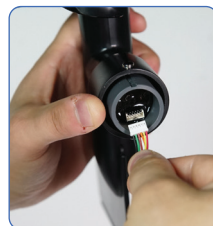

Figure I



Figure J



Figure K

# Station Assembly

## Align the PV Panel

- » Slightly loosen the 5mm hex bolt with included wrench, adjust the PV power panel angle to match your latitude as indicated in the table below, then re-tighten the bolt (fig L).



Figure L

Latitude	Angle from vertical	Clicks from vertical
0–22.5	75°	5
22.5–55	45°	3
55–90	15°	1



0 Clicks



1 Click (15°)



2 Clicks



3 Clicks (45°)



4 Clicks



5 Clicks (75°)



6 Clicks

# Station Assembly

## Install the Bird Guard

✦ *This step can be done on-site after the station is mounted.*

- » Remove the protective plastic film from the PV panel (fig M)
- » Loosen the screw, set the bird guard on the rim of the rain gauge bucket with the spike holes facing up, then tighten the screw and insert the spikes (fig N).
- » There is a black cable on the underside of the station that can be used to connect additional KestrelMet sensors. The sensor connector is covered by a black cap which should be left in place (fig O). For more information, visit [www.KestrelMet.com/Sensors](http://www.KestrelMet.com/Sensors)
- » Birds can trigger false rainfall readings if they perch on the rain bucket. The bird guard prevents this.



Figure M



Figure N



Figure O



**IMPORTANT:** Exercise caution when installing the spikes.

# 4 Connecting to Wi-Fi

- » Download the KestrelMet Utility app from your app store.

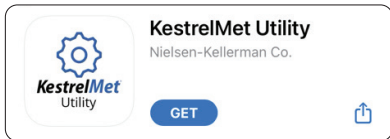

**NOTE:** An Android or iOS device is required to run the KestrelMet Utility App. The KestrelMet Utility App is the only way to send the required Wi-Fi connection information to your station.

- » Flip the toggle switch on the underside of the station base to “ON” (fig P).

✦ *It is best to minimize the number of On/Off cycles during station startup, as frequent switching can lead to Wi-Fi connection delays.*



Figure P

- » Immediately after the power is turned on, the status LED next to the solar panel will rapidly flash blue and then

slowly blink magenta. This indicates that it is powered on and ready for Bluetooth connection through the KestrelMet Utility app.

- » Open the KestrelMet Utility app. Your device may prompt you to allow device location access to be utilized. Your device may also prompt you to allow connection to nearby devices. The app will not function unless these permissions are granted.
- » The app will automatically open to the devices screen and search for KestrelMet Weather Stations within Bluetooth range. If the station does not appear after a few seconds, press the refresh button in the top right corner of the devices screen. Your default station name is the station's MAC address which is labeled on the underside of the station, as well as on the final page of this manual.

✦ *The green signal bars to the right of the station name indicate the station's Bluetooth signal strength. If 2 or fewer bars are displayed, move closer to the station.*

- » Press the blue “Connect” button to establish a Bluetooth connection to your station. A green “Connected” indicator will appear next to the Bluetooth signal indicator. Next, press the gray “Settings” button.
- » From the “Device Settings” screen, press “Network Settings” (fig Q)

✦ *You must use a 2.4 GHz frequency Wi-Fi network, see the troubleshooting section on Pg 21 for details.*

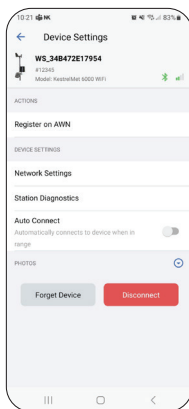

Figure Q

- » On the “Network Settings” screen, enter the Wi-Fi network name or select it from the drop down list. Then enter the network password. You can press the eye icon to view the password and confirm that it has been typed correctly. Press “Save”. The settings are now saved to the station and the app will return to the Device Settings screen. The LED light on the PV power panel will change from blinking magenta to blinking green when the station has connected to Wi-Fi. This may take up to 3 mins. While you are waiting you can register your station on AWN.

✦ *After the network information is saved to the station, the password is erased from the app for security.*

- » Refer to the troubleshooting guide on pg 21 if the LED status light does not blink green within 3 minutes of saving the network settings.

✔ **To conserve power, turn the station off if you don't plan on mounting it within 12 hours.**



# 5 Register Your Station

Register your station with Ambient Weather Network. You must register your station on the AWN website or app to view your weather station data. Download the AWN app from the app store to get the most out of your new KestrelMet.

- » From the “Device Settings” screen on the KestrelMet Utility App, press the “Register on AWN” button. Alternatively, you can open the AWN app or go to <https://AmbientWeather.net> and create an account or log in to an existing account. Select “Devices” (left menu on desktop browser, three-bar menu icon at bottom right on app) and select “Connect a New Device.”

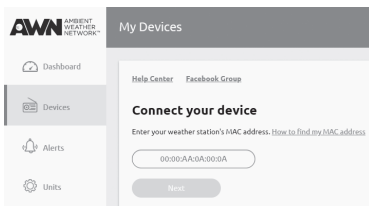
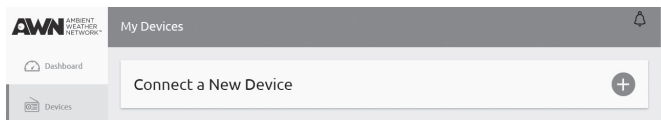
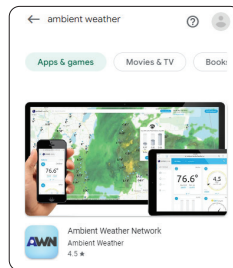

- » Paste or enter the MAC address of your KestrelMet 6000, which can be found on the last page of your manual or on the underside of the station. This will add your new station to your AWN account.
- » Complete the online registration process by entering the time zone and location for your weather station location.
- » Use the dashboard button to view station data (fig R). Your station may initially take up to 5 minutes to begin displaying data on AWN. Once the connection is established, the dashboard will update every minute and historical data will be saved every 5 minutes.

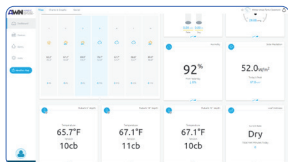

Figure R

# 6 Mounting

## Refer to [AmbientWeather.net/support](https://www.AmbientWeather.net/support)

- » Mount the station.  
*See appendix for Mono Mount and Tripod Mount mechanical drawings (pgs 32-33). Find detailed instructions and installation videos at [AmbientWeather.net/support](https://www.AmbientWeather.net/support)*
- » Confirm that the rain gauge bucket is level using one of these methods:
  - ✓ Place a level across the top of the rain bucket and take two readings perpendicular to each other (fig S & T).
  - ✓ Cover the rain gauge bucket drain with a piece of duct tape and add approx. 16 oz of water. If level, the edges of the water should be centered in the bottom of the bucket. Remove the tape to allow the water to pass through the drain and test the rain gauge (fig U).



Figure S

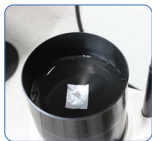



Figure U



Figure T

## Mounting Instructions:

- » Mount the support mast securely to the support structure using the Mono Mount or Tripod (sold separately) or standard U-bolts. Do not tighten the support structure to the KestrelMet, as directional orientation will be required.
  - » Rotate the assembled unit until the electronics enclosure with the solar panel cover faces south if you're in the Northern Hemisphere, or north if you're in the Southern Hemisphere. This will capture maximum solar energy and help the anemometer provide accurate wind direction. Use a compass for accuracy.
  - » Secure the support mast to the assembly. Prevent rotation by lining up the two holes in each mast
-  ***At this point, the entire unit should be secured to the support structure. It is crucial that the device is oriented as precisely as possible.***

# 7 Powering Up

After mounting the station, confirm the power is ON and the station is transmitting to **AmbientWeather.net** as shown in figure V.

✦ After a power cycle, data can take up to 5 minutes before it is shown on AmbientWeather.net

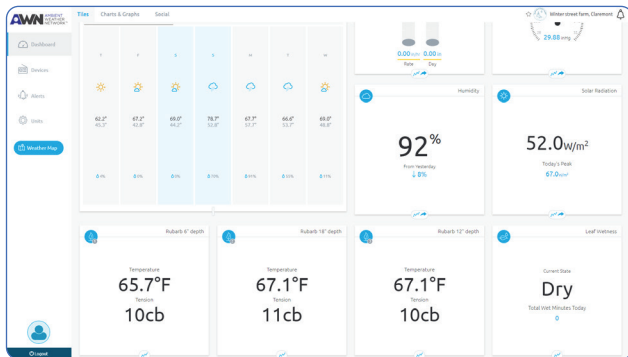

Figure V

# Troubleshooting

Refer to [AmbientWeather.net/Support](https://www.ambientweather.net/support) for FAQs and additional general troubleshooting information

Troubleshooting steps for connecting the station to a Wi-Fi network:

## 1. CONFIRM NETWORK FREQUENCY AND SIGNAL STRENGTH

The KestrelMet 6000 Wi-Fi weather station can ONLY connect to a 2.4 GHz Wi-Fi network. Combination 2.4/5 GHz dual band networks may need to be separated—consult your router manual for details. You can use third party tools such as a Wi-Fi analyzer app\* to confirm the frequency of a Wi-Fi network, as well as plan an optimal location for your station based on the signal strength. Note that the KestrelMet's antenna is more powerful than typical cell phone antennas, so even a signal strength reading of -90 dBm on your phone will typically still provide adequate strength for reliable KestrelMet data transmission.

## 2. CONFIRM NETWORK PASSWORD

You will need your Wi-Fi Network Name and Wi-Fi Network password for the following steps.

- Using your mobile phone, go to Settings and select the Wi-Fi network that will be used for connecting to your KestrelMet station.
- Enter you Wi-Fi password. If the phone connects, then you know that you have the correct password.

**Troubleshooting tip:** Make sure the network name and password you've entered are correct.

## 3. CONTACT KESTRELMET CUSTOMER SERVICE

(800) 784-4221 or (610) 447-1555, ext. 2; Mon-Fri: 9am-5pm EST

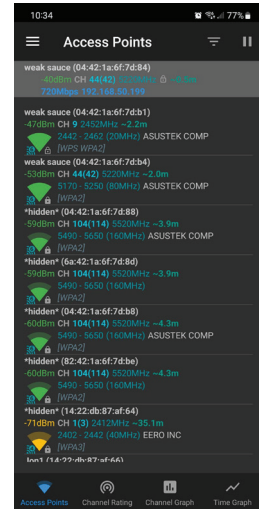

### Wi-Fi Analyzer App (Android)

*\*To identify network frequency with an iOS device, refer to this guide for using the AirPort*

*Utility app:  
<https://www.wikihow.com/Check-Wi-Fi-Ghz-on-iPhone>*



### **Additional Troubleshooting notes:**

- After your station is registered, you can use the signal indicators on **AmbientWeather.net/Devices** for live Wi-Fi signal readings. These readings will update every minute.
- The first and last channels of your router's broadcast band (ie channels 1 or 11) will typically provide the weakest Wi-Fi signal for your KestrelMet station. A Wi-Fi analyzer app will identify the channel that your router is using. Setting your router to use one of the inner channels (i.e. channel 6) can maximize the signal strength for your station. Consult your router manual or contact your internet service provider for information on setting your router channel.
- Data may take up to 3 minutes to display on the AWN dashboard. Data is saved to the station history every 5 minutes. Station history data represents a one minute average of all station measurements (i.e. a record with a time stamp of 9/16/2022 10:24:00 AM represents the averages of 10:23:01 to 10:24:00). During that time, the multicolor LED status light on the PV power panel will indicate the connection status:
  - Flashing **magenta** (every 10 seconds): Attempting to connect to a Wi-Fi network
  - Flashing **green** (every 10 seconds): Normal Operation
  - Flashing **blue** (every 10 seconds): Power Saver mode
  - Flashing **red** (every 10 seconds): Logging mode
  - Flashing **red** (every 20 seconds): Hibernation mode
- If the LED status light is flashing green but you AWN dashboard displays "There's no real-time data yet", click on the devices tab and double check that the Wi-Fi station MAC address on AWN matches the actual MAC address of the station. The station MAC address can be found on the label attached to the last page of the manual and on the label attached to the underside of the station, shown in Fig P. If the MAC listed on AWN is incorrect, click on the blue AWN logo under the Wi-Fi station name, and then click "delete this device". Then, click "Connect a new device" to repeat registration with the correct MAC address.

*The KestrelMet 6000 station is shipped with a fully charged battery and the station is designed to maintain normal operation in subfreezing weather. If solar charging is insufficient due to extended snow cover or installation in a shaded location, the station will change operating modes to conserve power as detailed in the station specifications operating mode table.*

**IMPORTANT:** If the station enters hibernation mode due to a depleted battery, the station must be left turned “on” and placed in direct sunlight to recharge. When the battery is charged sufficiently (typically 1-3 days), the station will switch back to Logging mode, then Normal Operation mode as charging allows. You will receive an email notification when the station returns to Normal Operation mode.



- In winter conditions, the rain gauge will not measure precipitation until the accumulated contents of the bucket have melted and drained through the strainer at the bottom of the bucket.

• **Equipment maintenance and service—Replacement of consumable materials (battery):**

If the battery must be replaced due to an extended low voltage situation, it can be replaced with a UB445 4V 4.5AH AGM (F1 terminals).

*Follow these steps:*

1. It is advisable to remove the station from the mount and turn it upside down for ease of disassembly and reassembly.
2. Remove the 4 screws on the battery cover.
3. Remove the 2 screws which hold the battery retaining board in place and move the retaining board to the side.
4. Detach the positive and negative leads from the battery terminals.
5. Remove the existing battery and replace it with a new battery.
6. Reattach the positive and negative leads to the respective battery terminals.
7. Replace the retaining board and fasten in place with the 2 screws that were removed.
8. Replace the battery cover and fasten in place with the 4 screws that were removed.

# Specifications

SENSORS	Accuracy (+/-)	Resolution	Range	Notes
<b>Wind Speed</b>	larger of 5% or 1 mph between 1 to 145 mph	0.1 mph 0.1 knot 0.1m/s 0.1 km/hr	1 to 145 mph 1 to 126 knots 1 to 64.8 m/s 1 to 233.4 km/hr	Wind speed is measured continuously and stored in station memory as a series of 2 second averages. The reported wind speed is the average over the 1 minute logging interval. The highest measured speed during the logging interval is reported as the gust value.
<b>Wind Direction</b>	2°	1°	1° ~ 360°	Wind direction is measured continuously and stored in station memory as a series of 2 second averages. The reported wind direction is the average scalar direction over the 1 minute logging interval. The gust direction is the average scalar direction for the 2 second record corresponding to the gust value.
<b>Temperature</b>	0.45° F 0.25° C	0.1° F 0.1° C	-40° to 140° F -40° to 60° C	Temperature is measured once per minute. High and low temperatures are based on the 1-minute readings.
<b>Relative Humidity (typical)</b>	1.5% between 0 - 80%	1%	0 to 100%	See fig T for accuracy tolerance over the RH range. Humidity is measured once per minute. High and low RH are based on the 1-minute readings.
<b>Absolute Pressure</b>	1.5 mbar/hPa 0.044 inHg 1.1 mmHg	0.1 mbar/hPa 0.01 inHg 0.1 mmHg	600 to 1100 mbar/hPa 17.72 to 32.48 inHg 450.0 to 825.1 mmHg	Pressure is measured once per minute. High and low pressures are based on the 1-minute readings.
<b>Rain Rate</b>	5% at 2"/hr (5% upgradeable to 2%)	0.01 in/hr 0.1 mm/hr	0 to 7.8 in/hr	Rainfall is measured continuously in 0.2 mm increments (tipping bucket calibration volume)

 **NOTE:** Specifications for optional sensors can be found on the sensor product pages at [KestrelMet.com](https://www.kestrelmet.com).



## Relative Humidity (typical)

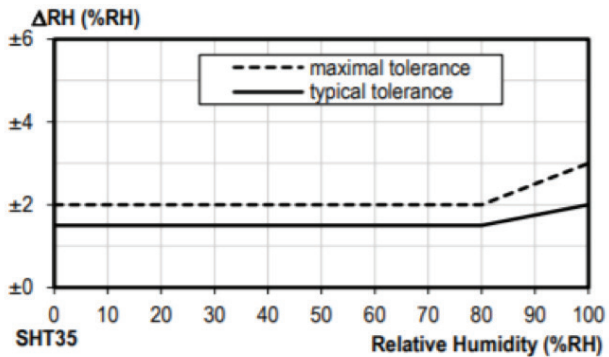

Figure W

## SYSTEM

<b>Operating Environment Temperature:</b>	-40° to 140° F (-40° - 60°C)
<b>Altitude Operating Range:</b>	Sea level to 10,000m / 33,000 ft
<b>Pollution Degree of the Intended Environment:</b>	2
<b>Dimensions:</b>	11"x23"x36" (28 x 58 x 91 cm)
<b>Weight:</b>	8.9 lbs (4.04 kg)
<b>Certifications:</b>	FCC, CE, IC
<b>Data Cache Capacity:</b>	365 Days
<b>Logging Rate:</b>	Every 1 minute (See sensor specification notes for details)*
<b>Wi-Fi Transmission Rate:</b>	Every 1 minute
<b>AWN Data Storage Rate:</b>	Every 5 min (standard free plan)
<b>Battery Type:</b>	UB445 non-spillable 4V 4.5Ah AGM sealed lead-acid 1A peak, 12 mA typical
<b>Battery Life:</b>	2 to 5 years typical
<b>Solar Panel Type:</b>	Monocrystalline 7V 2.3 W
<b>Warranty</b>	2 years

STATION OPERATING MODES	Standard	Power Saver	Logging	Hibernate	Recharge
<b>Battery Status:</b>	Battery Charged	Low Battery	Critically Low Battery	Critically Low Battery	Critically Low Battery
<b>Aspirated Sensor Measurement Frequency:</b>	1 min*	2 mins	5 mins	None	None
<b>Wi-Fi Data Transmission Frequency:</b>	1 min*	15 mins	24 hrs	None	None
<b>Panel LED Status Light Color:</b>	Green	Blue	Red	Red	None
<b>LED Status Light Blink Frequency:</b>	10 sec	10 sec	10 sec	20 sec	None

\*1 minute dashboard updates on AWN and 1 minute data available via Ambient Realtime API

# Product and Safety Information



**WARNING:** Read and follow these guidelines to reduce the risk of injury or death.

- ✓ Fully read your KestrelMet 6000 user manual to familiarize yourself with the product's features before operating.
- ✓ Failure to operate this product correctly can damage it or produce inaccurate readings.
- ✓ Use good judgement whenever you rely on station readings to make decisions regarding safety, health or property protection.
- ✓ Allow a margin of safety for changing conditions and reading errors (2–3% of readings is recommended).

Be certain your weather station's accuracy has not been compromised by improper installation, contamination or damage. When in doubt, verify your weather station's accuracy against a known good standard for the measurement in question, and contact Kestrel Instruments Technical Support with any questions or concerns.



**NOTICE:** All instructions and associated documents are subject to change at the sole discretion of the manufacturer. For up-to-date product information, visit [kestrelinstruments.com/support](https://kestrelinstruments.com/support)

# Compliance



To satisfy FCC RF exposure requirements for mobile transmitting devices, a separation distance of 25 cm or more should be maintained between the antenna of this device and persons during device operation. To ensure compliance, operations at closer than this distance are not recommended. The antenna used for this transmitter must not be co-located in conjunction with any other antenna or transmitter.



KestrelMet 6000 contains approved transceiver modules :

IC IDs: 12368A-KMET6000W and 12246A-BM71S2

This product was type-tested and found to comply with the limits for a class B computing device in accordance with the specifications in ICES-003 and Part 15 of FCC rules.

**CAUTION!** This equipment is approved for mobile and base station transmitting devices only. Antenna(s) used for this transmitter must be installed to provide a separation distance of at least 25 cm from all persons and must not be co-located or operating in conjunction with any other antenna or transmitter.

**ATTENTION!** Cet équipement est approuvé pour la mobile et la station base dispositifs d'émission seulement Antenne(s) utilisé pour cet émetteur doit être installé pour fournir une distance de séparation d'au moins 25 cm à partir de toutes les personnes et ne doit pas être situé ou fonctionner en conjonction avec tout autre antenne ou émetteur.

# Compliance

## FCC and ISED Compliance Information

PN: 621632

FCC ID: 2ADAJ-KMET6000W

### FCC Compliance Statement

This device complies with part 15 of the FCC Rules. Operation is subject to the following two conditions:

- (1) this device may not cause harmful interference, and
- (2) this device must accept any interference received, including interference that may cause undesired operation.

This equipment has been tested and found to comply with the limits for a Class B digital device, pursuant to part 15 of the FCC Rules. These limits are designed to provide reasonable protection against harmful interference in a residential installation. This equipment generates, uses, and can radiate radio frequency energy and, if not installed and used in accordance with the instructions, may cause harmful interference to radio communications. However, there is no guarantee that interference will not occur in a particular installation. If this equipment does cause harmful interference to radio or television reception, which can be determined by turning the equipment off and on, the user is encouraged to try to correct the interference by one or more of the following measures:

- Reorient or relocate the receiving antenna.
- Increase the separation between the equipment and receiver.
- Connect the equipment to an outlet on a circuit different from that to which the receiver is connected.
- Consult the dealer or an experienced radio/TV technician for help.

Changes or modifications not expressly approved by Nielsen-Kellerman could void the user's authority to operate the equipment.

### RF Exposure

This equipment complies with FCC and Industry Canada radiation exposure limits set forth for an uncontrolled environment and meets the FCC and Industry Canada radio frequency (RF) Exposure Guidelines. This equipment has very low levels of RF energy that are deemed to comply without testing of specific absorption rate (SAR).

# Compliance

## IC Statement

This device contains license-exempt transmitter(s)/receiver(s) that comply with Innovation, Science and Economic Development Canada's license-exempt RSS(s). Operation is subject to the following two conditions:

- (1) This device may not cause interference.
- (2) This device must accept any interference, including interference that may cause undesired operation of the device.

Cet appareil contient un ou des émetteurs/récepteurs exempts de licence conformes aux RSS exempts de licence d'Innovation, Sciences et Développement économique Canada. Le fonctionnement est soumis aux deux conditions suivantes:

- (1) Cet appareil ne doit pas provoquer d'interférences.
- (2) Cet appareil doit accepter toute interférence, y compris les interférences pouvant entraîner un fonctionnement indésirable de l'appareil.

# Compliance



## EU Declaration of Conformity

This product was tested and found to comply with EU Council Radio Equipment Directive 2014/53/EU (RED).

EN 61010-1, SAFETY REQUIREMENTS FOR ELECTRICAL EQUIPMENT

EN 55022, Enclosure of Ancillary Equipment

EN 61000-4-3, Radio Frequency Electromagnetic Field

EN 61000-4-2, Electrostatic Discharge

This product contains:

ESPRESSIF SYSTEMS Wi-Fi & Bluetooth Internet of Things Module, Model ESP32-C3-MINI-1U, with a manufacturer Declaration of Conformity to EU Council Radio Equipment Directive 2014/53/EU (RED).

Microchip Inc Bluetooth Module, Model RN4871, with a manufacturer

Declaration of Conformity to EU Council Radio Equipment Directive 2014/53/EU (RED).



RoHS (Reduction of Hazardous Substances) compliant.



Marked in accordance with the WEEE (Waste Electrical and Electronic Equipment) Directive.

**Please do not dispose of the Kestrel batteries in your household trash.** Return to NK, an NK dealer, or a designated recycling center for proper recycling and disposal.



Does not contain greater than >0.1% of the substances of Very High Concern (SVHC) on the REACH European Regulation on the Registration, Evaluation, Authorization and Restriction of Chemicals Candidate List.

## CONTACT US AT

[www.KestrelMet.com](http://www.KestrelMet.com)

[Techsupport@nkhome.com](mailto:Techsupport@nkhome.com)

(800) 784-4221 Toll-Free North America

(610) 447-1555 Continental US

# Proposition 65 Warning



**WARNING:** This product and/or its included or branded accessories can expose you to chemicals, including lead, lead compounds and phthalate DEHP, which are known to the State of California to cause cancer, and lead and lead compounds, bisphenol A (BPA), and phthalate DnHP, which are known to the State of California to cause birth defects or other reproductive harm. For more information, go to [www.P65Warning.ca.gov](http://www.P65Warning.ca.gov).

## More Information

Many of the elements listed under Proposition 65 are commonly found in products in the electronics industry. Although Kestrel Instruments' manufacturing process is "lead-free," it remains possible that small amounts of lead could be found in components or subassemblies. Bisphenol A (BPSA) could be found in plastic housings, lenses, labels or adhesives, and DEHP & DINP (phthalates) could be found in PVC wire coatings of cables, housings, carrying cases, an/or power cords. Because we cannot guarantee that these chemicals are never present, we have elected to place the warning on our products to ensure compliance with California law and our customers' right to know. While we have not attempted to evaluate exposure, we believe that normal consumer use of this product is unlikely to result in exposure that creates a significant risk of harm. For more information visit [kestrelinstruments.com/Prop65](http://kestrelinstruments.com/Prop65) or contact us directly at [techsupport@nkhome.com](mailto:techsupport@nkhome.com).



# Warranty



Your **KestrelMet 6000 Wi-Fi Weather Station** from Nielsen-Kellerman is warranted to be free of defects in materials and workmanship for a period of **TWO YEARS** from the date of its first consumer purchase. Nielsen-Kellerman agrees to repair or replace any defective damage due to the product or part when notified within the warranty period without charge.

The following are excluded from warranty coverage: damage due to improper use, abuse, accident and/or lack of reasonable care; improper storage, maintenance or handling (including corrosion); the fixing of any attachment not provided with the product; lightning strike and/or power surge.

Removal/reinstallation charges and any warranty service performed by a non-authorized repair service are also not covered. NK assumes no responsibility for any special, incidental or consequential damages and NK authorizes no other warranty, written or oral.

**This warranty gives you specific legal rights, and you may have other rights, which vary from state to state. Some states do not allow the exclusion of incidental or consequential damages, and so the above exclusions and limitations may not apply to you.**

To return a unit under warranty: Contact Nielsen-Kellerman for Return Authorization.

Make sure equipment is properly packed - preferably in the original box. Damage incurred in shipping is not covered under this warranty.



# Appendix 1:

## Tripod Mechanical Drawings

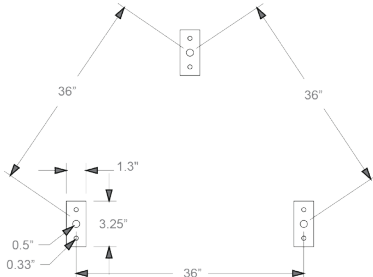
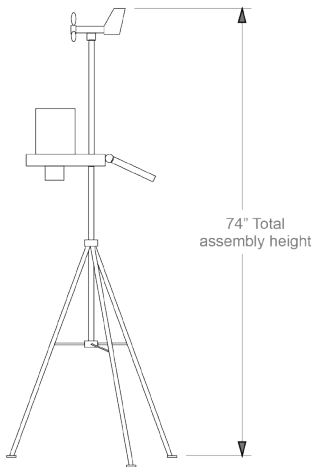

# Appendix 2:

## Mono Mount Mechanical Drawings

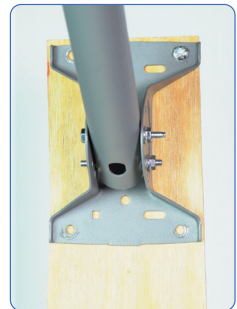
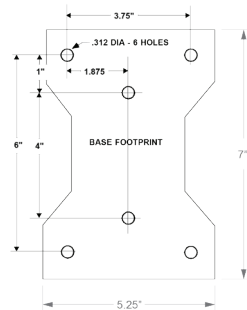
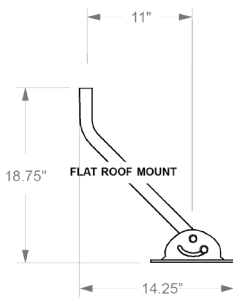
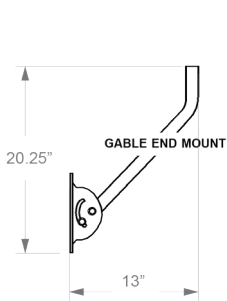

# Appendix 3:

## Optional AG Sensors



More Information at [www.KestrelMet.com/AG](http://www.KestrelMet.com/AG)

## Solar Irradiance Sensor

---

The solar irradiance sensor comes pre-wired to the station, but the metal bracket needs to be attached to the station base.

In the plastic bag, you'll find two stainless steel Phillips head screws. Use these to attach the solar irradiance sensor bracket to station base. See red arrows in Fig 1.

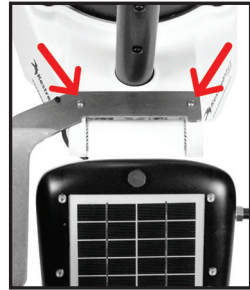

Figure 1

## Soil Sensor Array

---

The soil sensor array consists of 3 probes, each on a 15' cable. Each probe measures soil water tension using a Watermark sensor and soil temperature. Probes are typically buried at 3 different depths corresponding to the root zone of the target vegetation.

Before connecting the soil sensor array, flip the power switch on the underside of the station to the "off" position. Remove the black protective cap from the silver aux sensor connector on the underside of the station.



Figure 2

# Soil Sensor Array Connector

Align the ridge on the inside of the station connector with the channel on the soil sensor array connector (see red arrows). Press the two fittings together as you screw the threaded metal coupling together. You should feel detent ridges as the threads are tightened together completely. A completely tightened fitting may still have some threads showing between the two sides of the coupling, as shown on the far right in Fig 3. Once the coupling is tight, the station can be powered on and will begin transmitting soil temperature and soil water tension data. Note: Wrenches are not required to achieve a watertight connection.

The white housing of the soil array sensor can be attached to the lower section of the station mast using the provided zip ties. Take care to attach it so that there is no tension on the cable going to the station or on the cables connecting the soil probes.

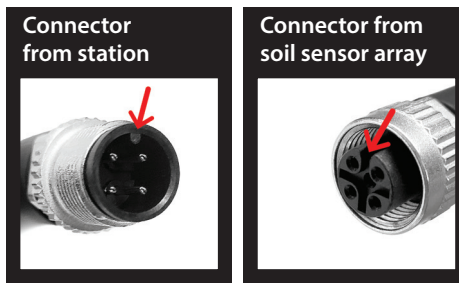

Figure 3



Figure 4

# Soil Sensor Array Probe ID

Probe numbers are marked with zip ties as shown in Fig 5. (i.e. The probe with two zip ties will be displayed as Soil Moisture 2 / Soil Temperature 2 on your dashboard) Make a note of the depth for each probe. The sensor names on your Ambient Weather Network dashboard can be edited to include the depth (i.e. Soil Moisture 36")

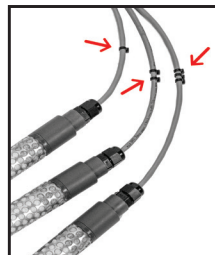

Figure 5

## Soil Sensor Array Probe Placement Overview

*Plan soil sensor array locations and probe depths according to your application. The recommended references in this manual provide guidance based on soil type, crop type, and irrigation options.*

### Recommended tools and supplies:

7/8" soil auger or coring tool, 3/8" dowel or rod, bucket, water jug, zip ties

**Note:** if seasonal sensor removal is required, 1" Sch 40 PVC pipe can be attached to each probe with provided adapters and screws and/or PVC cement. See red arrows in Fig 6.



Figure 6

1. Soak probes overnight in irrigation water. Several soak/dry cycles are recommended for new probes.
2. Cut dowel or 1" Sch 40 PVC pipe to desired lengths and mark target depth. If pipe is left in place, it should be capped.
3. Drill a 7/8" hole to the desired depth.
4. Prepare 2-3 cups of a soil slurry (no rocks or organic matter).
5. Pour slurry into hole to a depth of 2-3"
6. Insert soil probe into hole and press into the slurry.
7. Pour remaining slurry into the hole and tamp using the dowel.



## Manuals & Websites

---



[AmbientWeather.net/Support](https://AmbientWeather.net/Support)



## Frequently Asked Questions

---



[kestrelmet.com/kestrelmet-6000-cellular-weather-station](https://kestrelmet.com/kestrelmet-6000-cellular-weather-station)



## Manuals and websites:

*The KestrelMet 6000 AG Weather Station helps farmers and operators maximize yields with the minimum required resources. Here you'll find helpful guidance and information regarding best practices in irrigation management.*

Watermark installation manual

<https://www.irrometer.com/pdf/instruction-manuals/landscape/712%20InstallToolMnl%20web1.pdf>

Available Water Conversion Tables for Soil Moisture Monitors

<https://waterquality.montana.edu/farm-ranch/irrigation/irrigation-tools/shallow-conversion.html>

Irrigation Scheduling Strategies When Using Soil Water Data

<https://extensionpubs.unl.edu/publication/9000020403114/irrigation-scheduling-strategies-when-using-soil-water-data/>

How to use Watermark sensors for irrigation

<https://www.uaex.uada.edu/publications/pdf/FSA57.pdf>

Moisture Sensor Agricultural Irrigation Design Manual

<https://www.irrometer.com/pdf/supportmaterial/ADG2006.pdf>

Soil water tension irrigation criteria for various crops

<https://catalog.extension.oregonstate.edu/sites/catalog/files/project/pdf/em8900.pdf>

Watermark Granular Matrix Sensor to Measure Soil Matric Potential for Irrigation Management

<https://extensionpublications.unl.edu/assets/pdf/ec783.pdf>



**Manufactured and Distributed by:**

**NIELSEN-KELLERMAN**

21 Creek Circle, Boothwyn, PA 19061

Phone Continental US: (610) 447-1555

Phone International: (800) 784-4221

[www.KestrelMet.com](http://www.KestrelMet.com)

[info@KestrelMet.com](mailto:info@KestrelMet.com)



**PROUDLY DESIGNED  
AND BUILT IN THE USA**