

# ASSEMBLY INSTRUCTION

DDP-2292L

**A**  3.5x30=43x

## PARTS

**1** x4

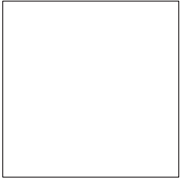

**2** x2

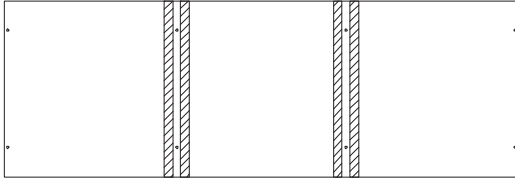

**3**

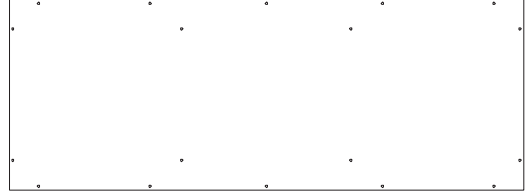

**4**



## ASSEMBLY

**1**

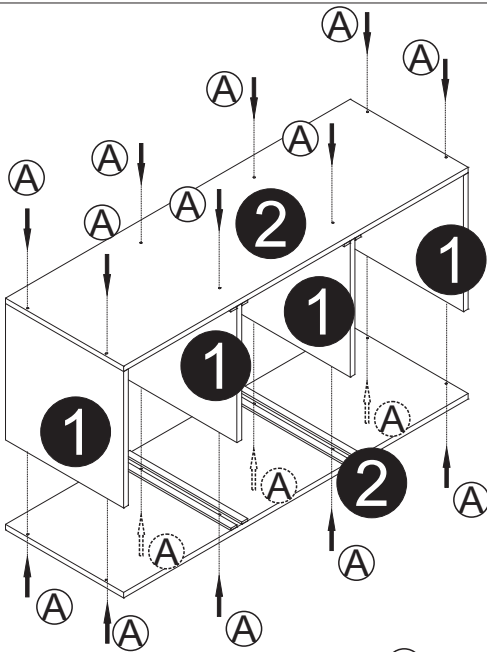

**A**  x16    **A**  x18

**2**

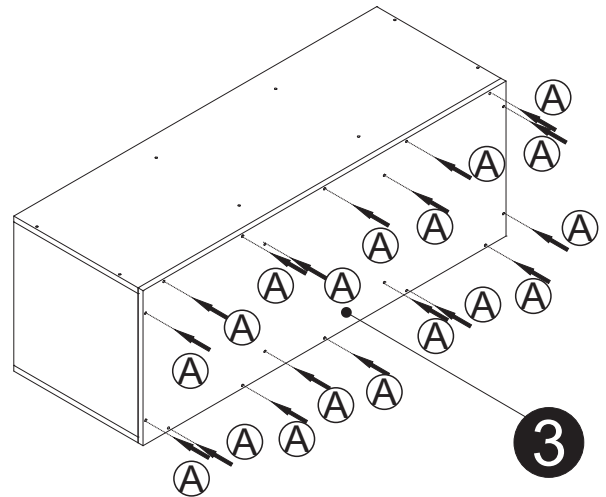

**3**

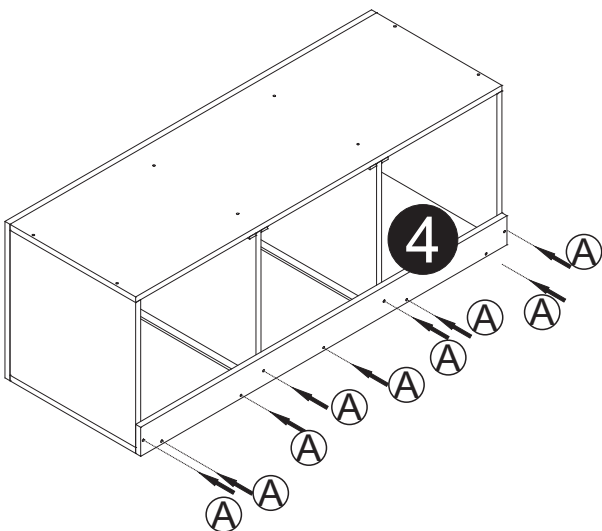

**A**  x9