

# SOJAG

produits saisonniers • seasonal products

QUESTIONS? 1 866-901-1649

## Assembly Manual / Guide d'assemblage / Manual de ensamblaje / 조립설명서 / Montageanleitung

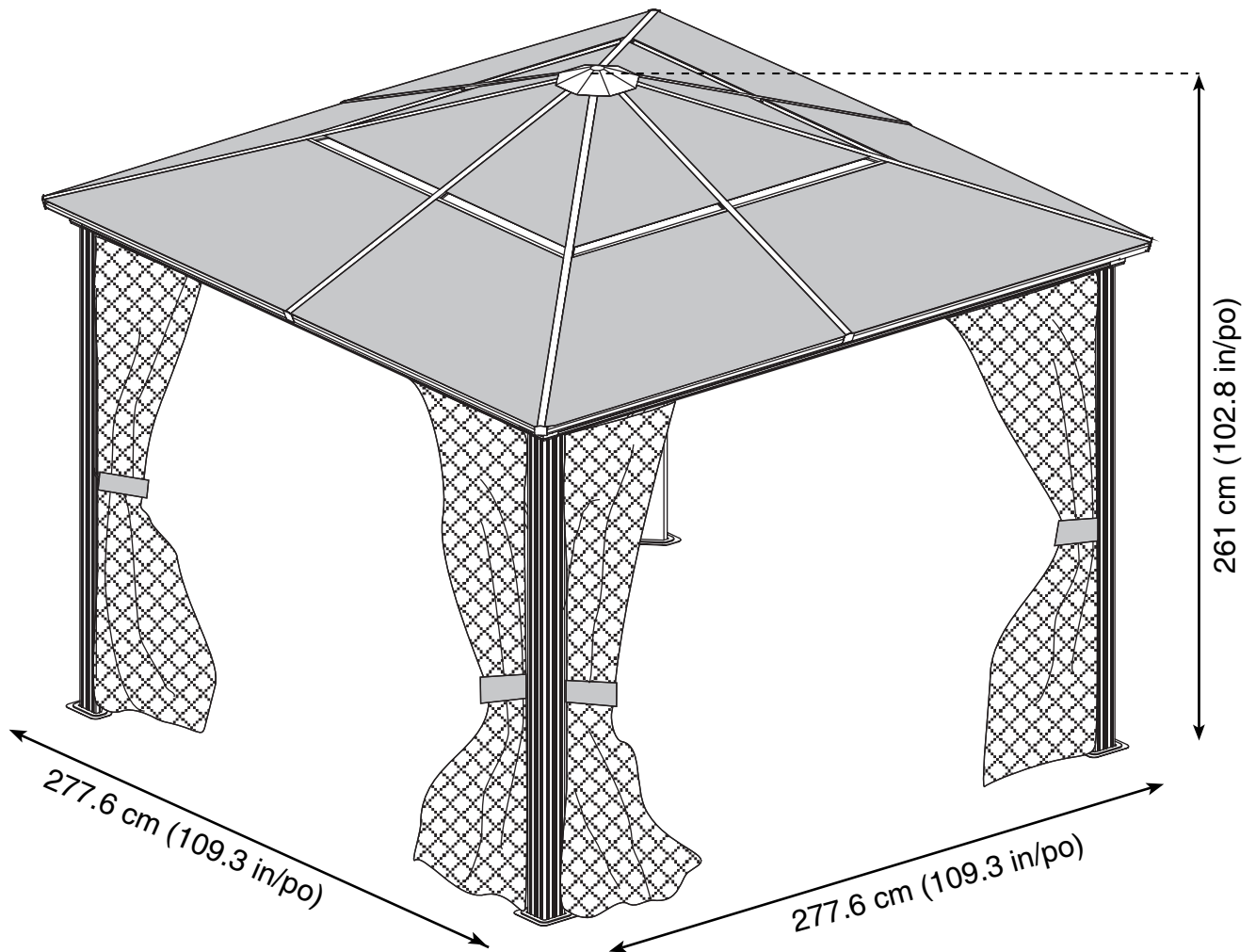

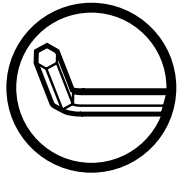

Use the hex keys in the box. / Utilisez les clés hexagonales fournies dans la boîte. / Utilice las llaves hexagonales en la caja. / 상자에 육각 키를 사용 하십시오. / Verwenden Sie die Sechskantschlüssel in der Box.

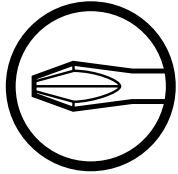

Please use a Phillips screwdriver. / Utilisez un tournevis de type Phillips / Por favor, use un destornillador Phillips. / 십자 드라이버를 사용 하십시오. / Bitte verwenden Sie einen Kreuzschraubenzieher.



You may need to use a drill for this step. / Vous pouvez avoir besoin d'utiliser une perceuse pour cette étape. / Puede que tenga que utilizar un taladro para este paso. / 이 단계에선 드릴을 사용해야 할 수도 있습니다. / Für diesen Schritt können Sie einen Bohrer verwenden.



Wearing protective gloves is recommended. / Le port de gants de protection est recommandé / El uso de guantes de protección se recomienda. / 보호 장갑을 착용 하는 것이 좋습니다. / Das Tragen von Schutzhandschuhen wird empfohlen.



Two or more people are required at this stage. / Deux personnes ou plus sont nécessaires à cette étape. / Dos o más personas se requieren en esta etapa. / 이 단계에서는 두 명 이상 이 필요합니다. / Für diesen Bauschritt sind 2 oder mehr Personen erforderlich.



Do not tighten screws all the way for now. / Ne pas visser fermement pour l'instant. / No atornille con firmeza por ahora. / 아직 나사를 단단히 조이지 마십시오. / Bitte die Schrauben zum jetzigen Zeitpunkt noch nicht fest anziehen.

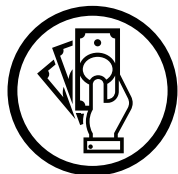

Sold separately. / Vendus séparément. / vendido en las opciones. / 옵션 판매 / Optional erhältlich



Optional step / Étape optionnelle / Paso opcional / 선택적 단계 / Optionaler Schritt

**U** X28(+3)

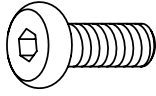

**U1** X 48 (+5)

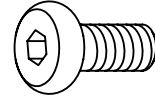

**U2** X 1 (+1)



**V** X 16 (+3)

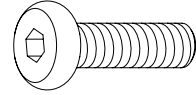

**W** X 8 (+2)

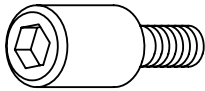

**X** X 8 (+2)

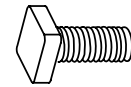

**X1** X 24 (+6)



**Y** X 16 (+4)

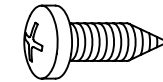

**Y1** X 16 (+4)

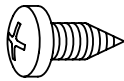

**Z** X 1

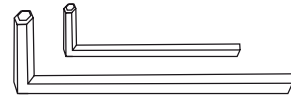

**Z1** X 2

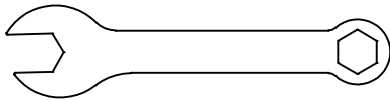

**Z2** X4(+1)

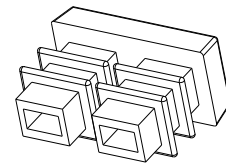

**A** X4



**B** X4



**D** X4

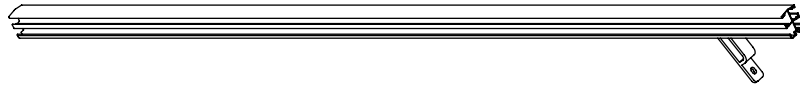

**E** X4

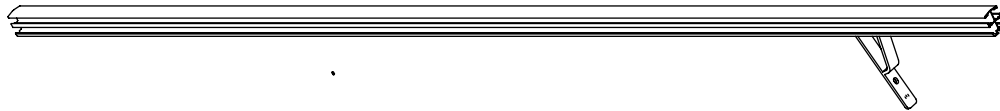

**F** X4



**F1** X4

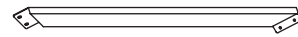

**G** X4



**G1** X4





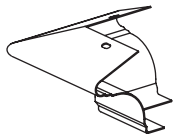





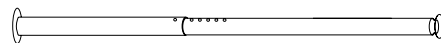

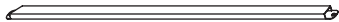
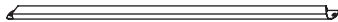
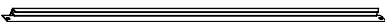

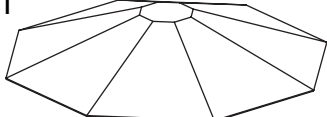
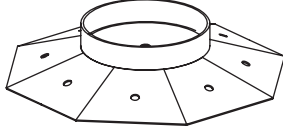
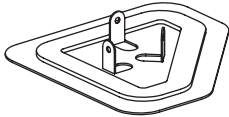
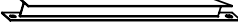
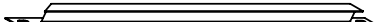
**J1** X4

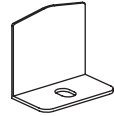
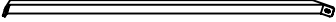
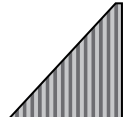
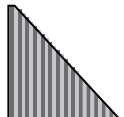
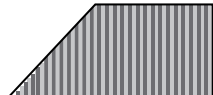
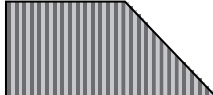

**A98** X1

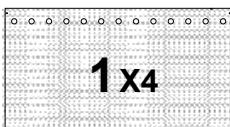
Winter Bar!"윈터! 바!

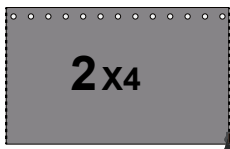

<b>H</b> X4 	<b>H1</b> X4 	
<b>I</b> X4 	<b>I1</b> X4 	
<b>K</b> X1 	<b>K1</b> X1 	<b>L</b> X4 
<b>N</b> X4 	<b>N1</b> X4 	
<b>O</b> X4 	<b>O1</b> X4 	
<b>Q</b> X4 	<b>Ma</b> X4 	
<b>M1a</b> X4 	<b>Mb</b> X4 	
<b>M1b</b> X4 	<b>T</b> X 48 (+2) Optional   <b>T</b> X 48 (+2) Optional 	
<b>Net</b>  <b>1</b> X4 Optional 	<b>Curtain</b>  <b>2</b> X4 Optional 	

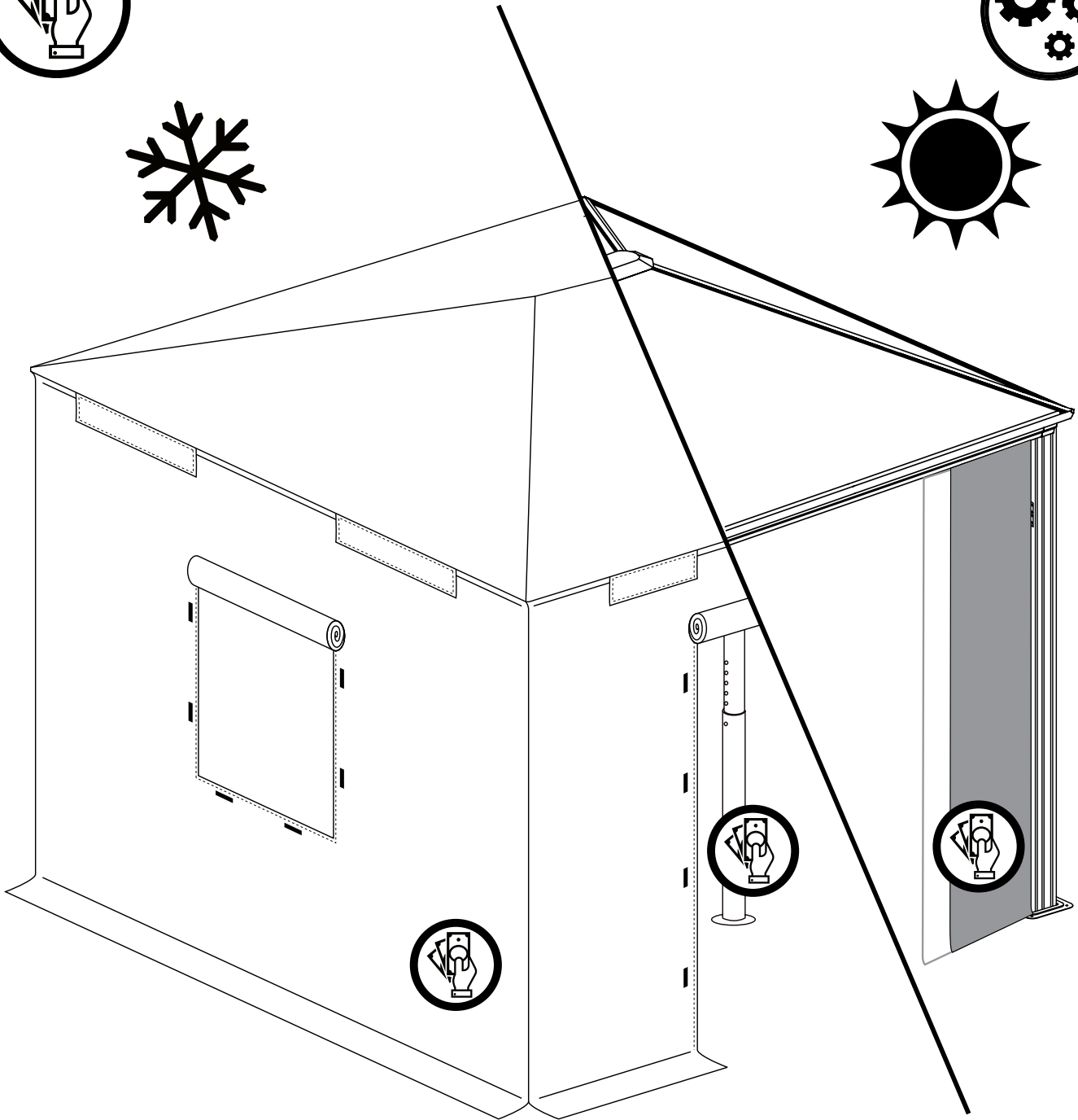
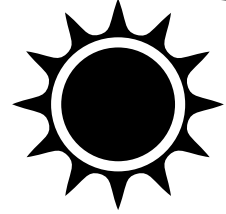
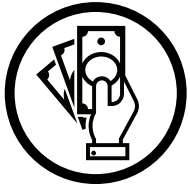

A98 x1



Rx1

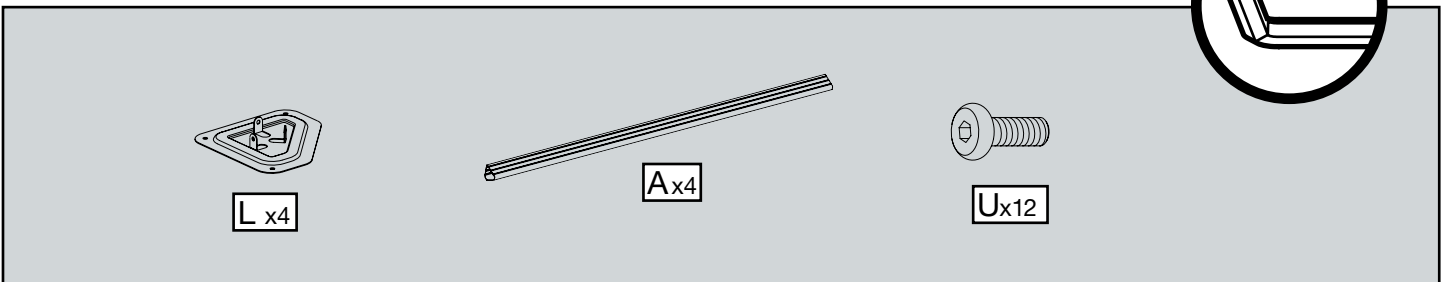
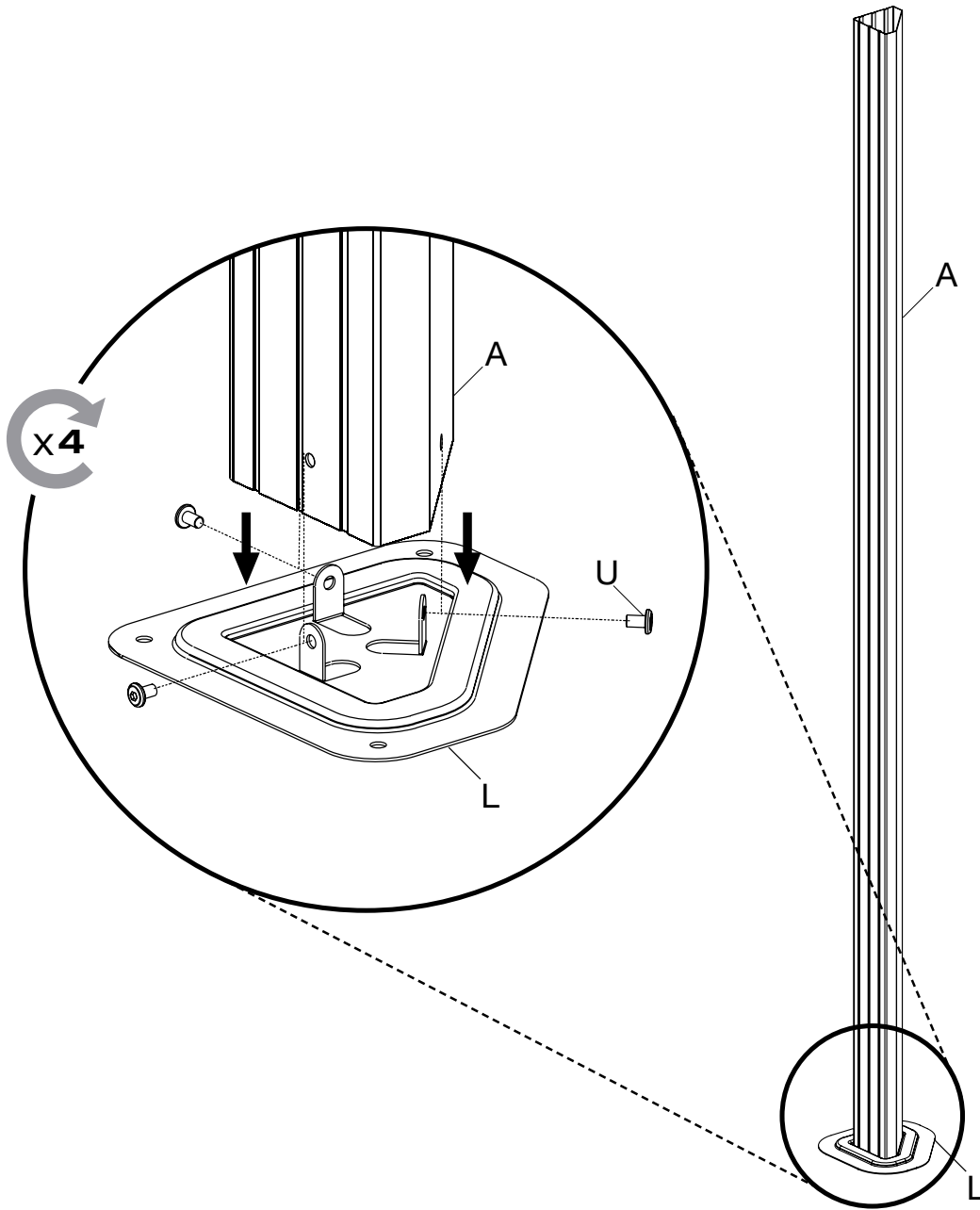

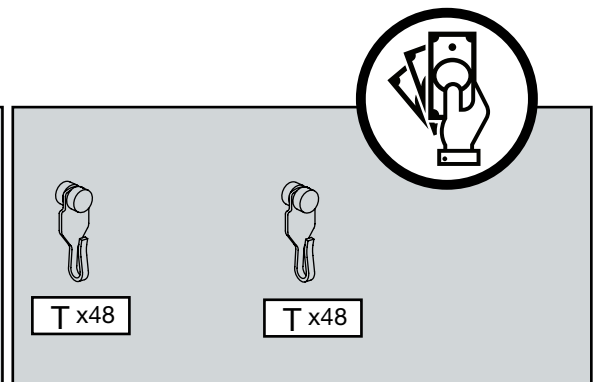
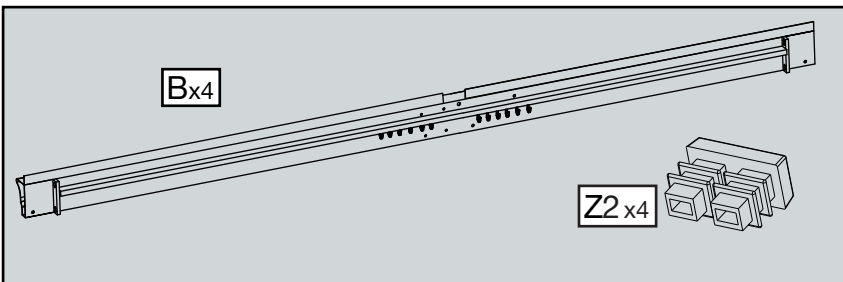
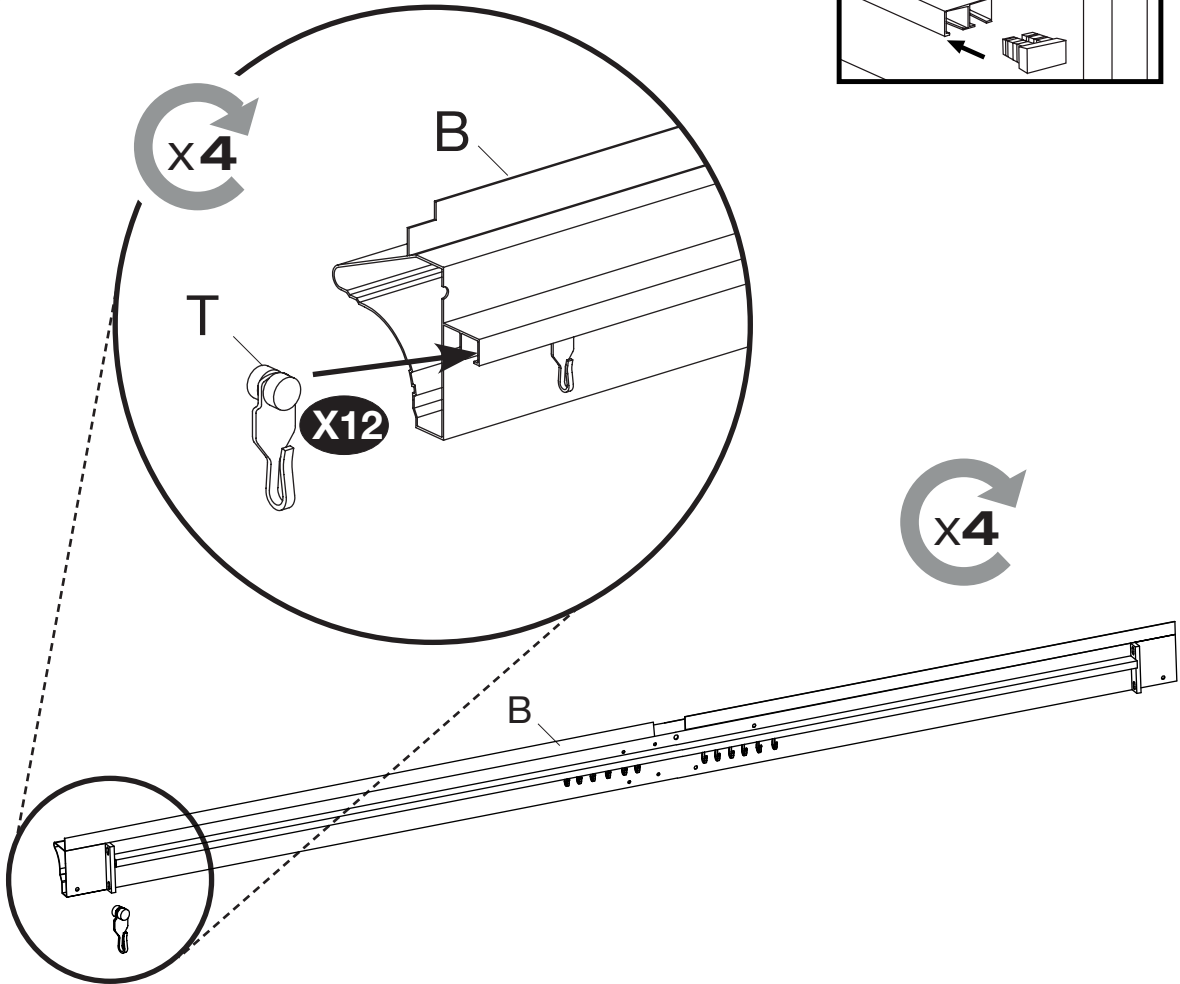
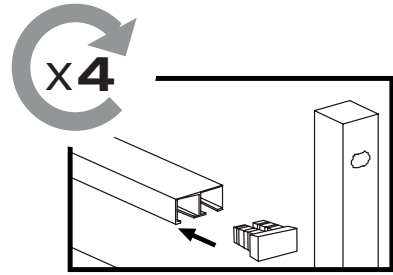



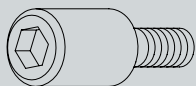
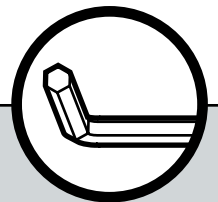
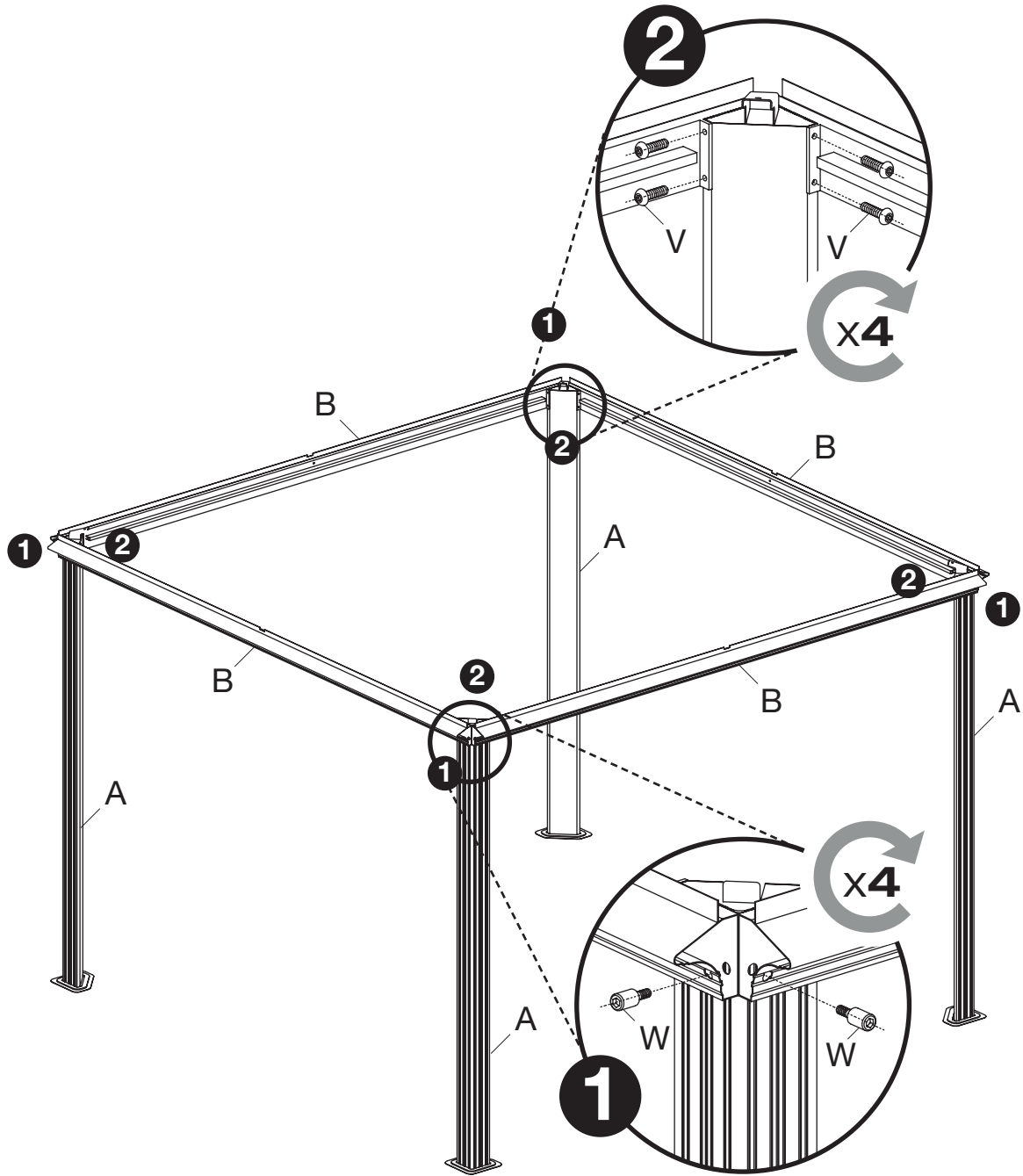

W x8

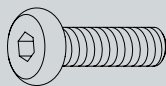

V x16

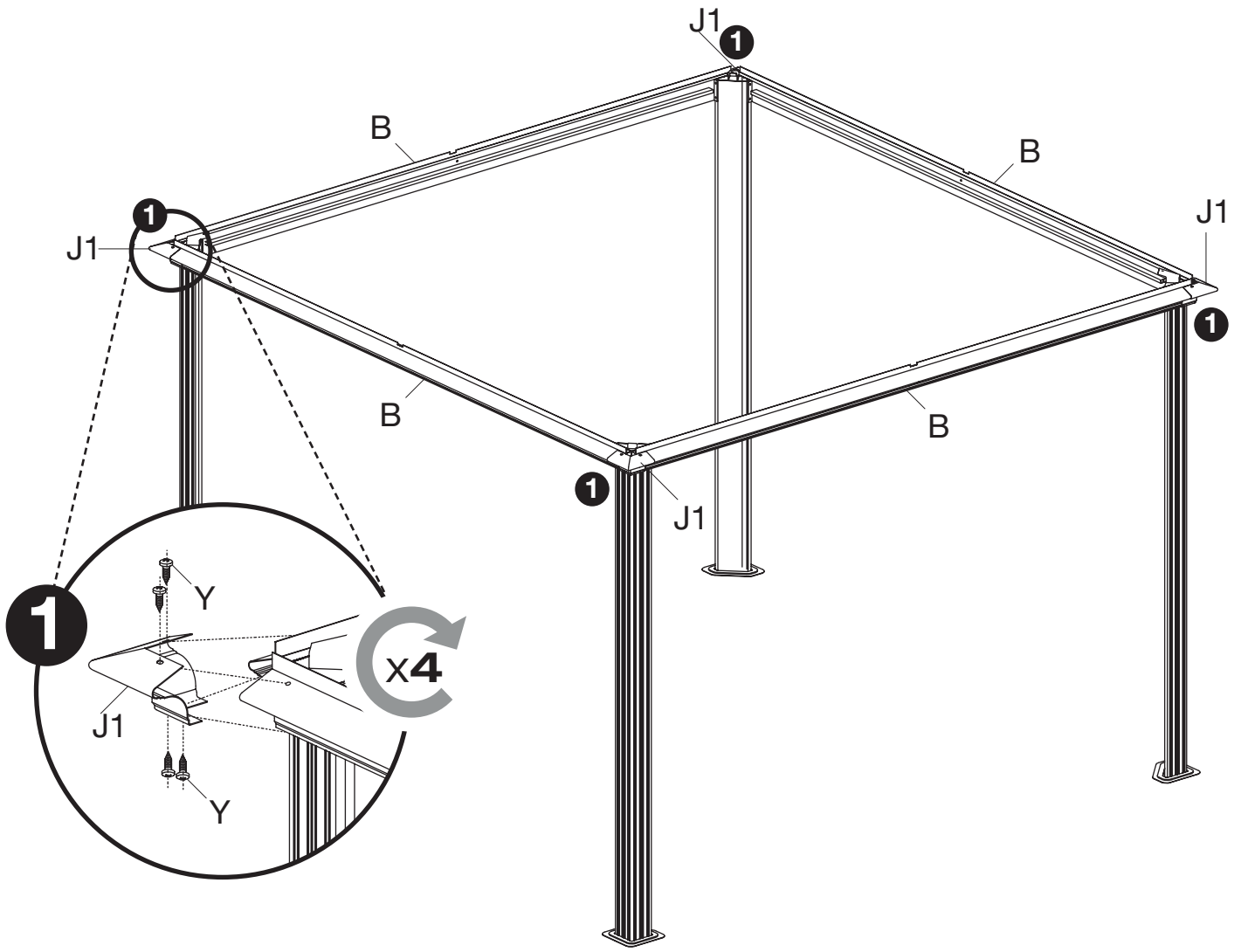

This section contains the parts list for the assembly step. It includes:

- A screw labeled Y x16.
- A corner bracket labeled J1 x4.
- A circular icon showing a corner bracket being used to join two beams.

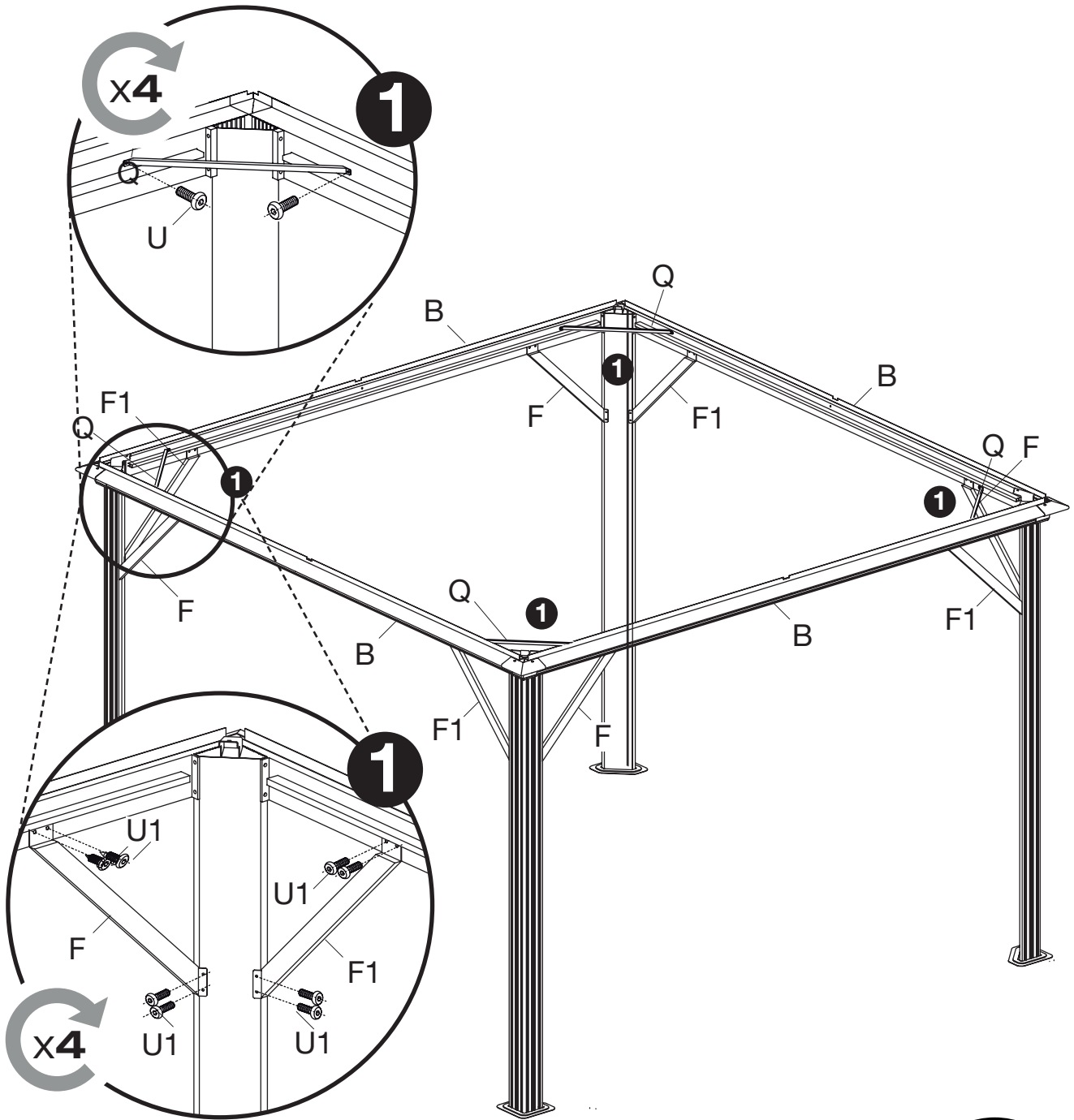

Parts list section showing components:

- F x4
- F1 x4
- Q x4
- U x8
- U1 x32

A circular icon shows a corner joint detail.

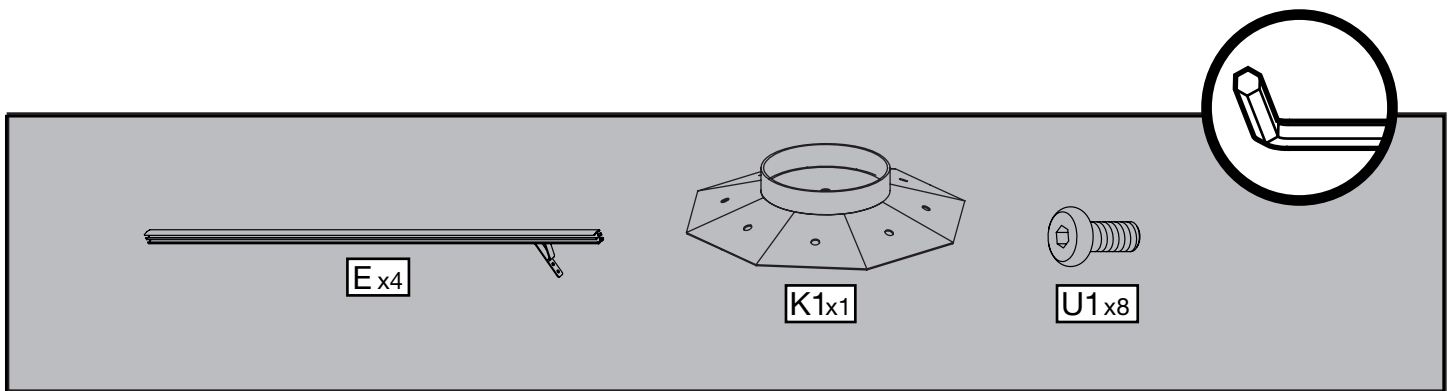
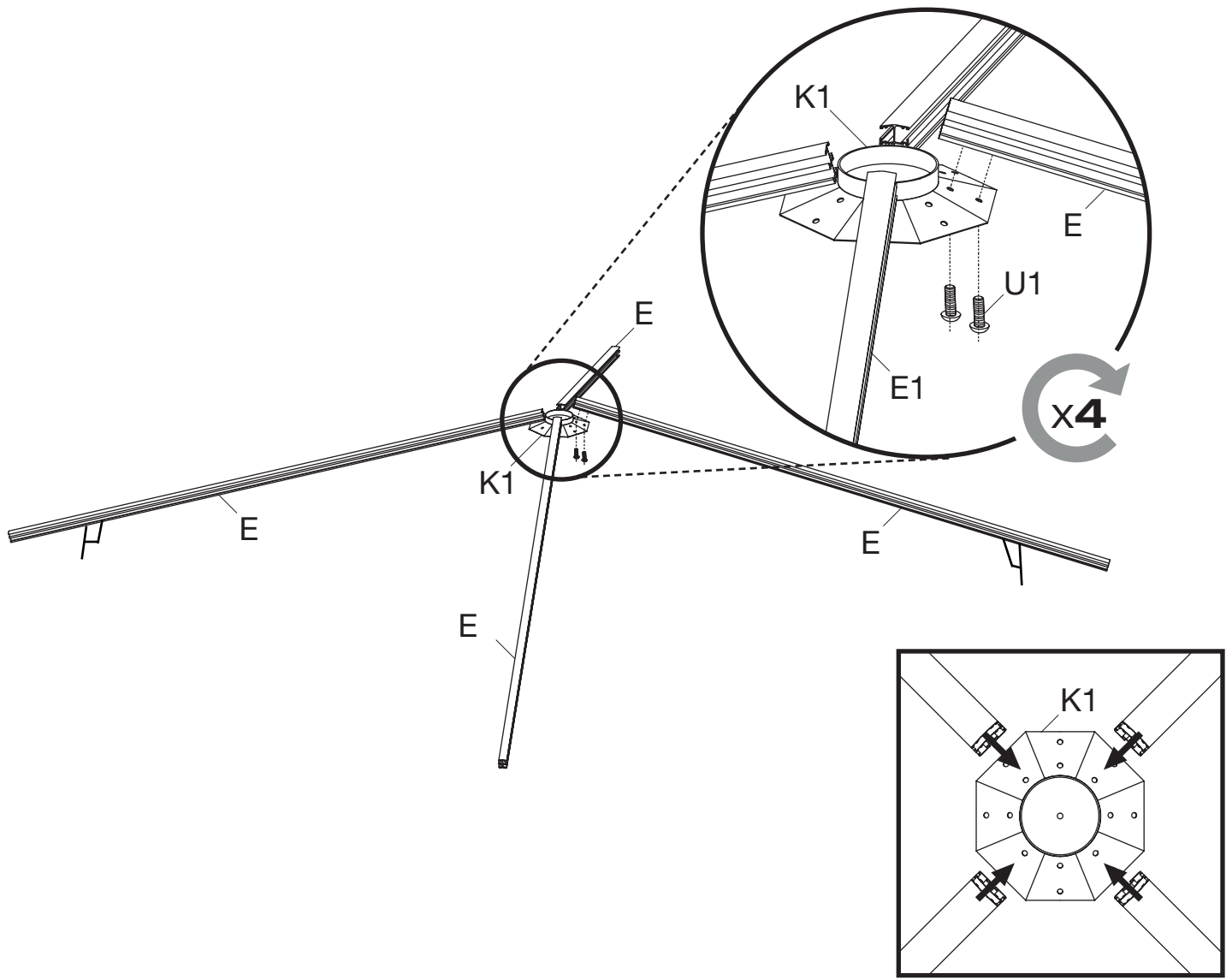

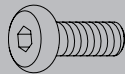
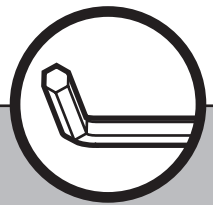
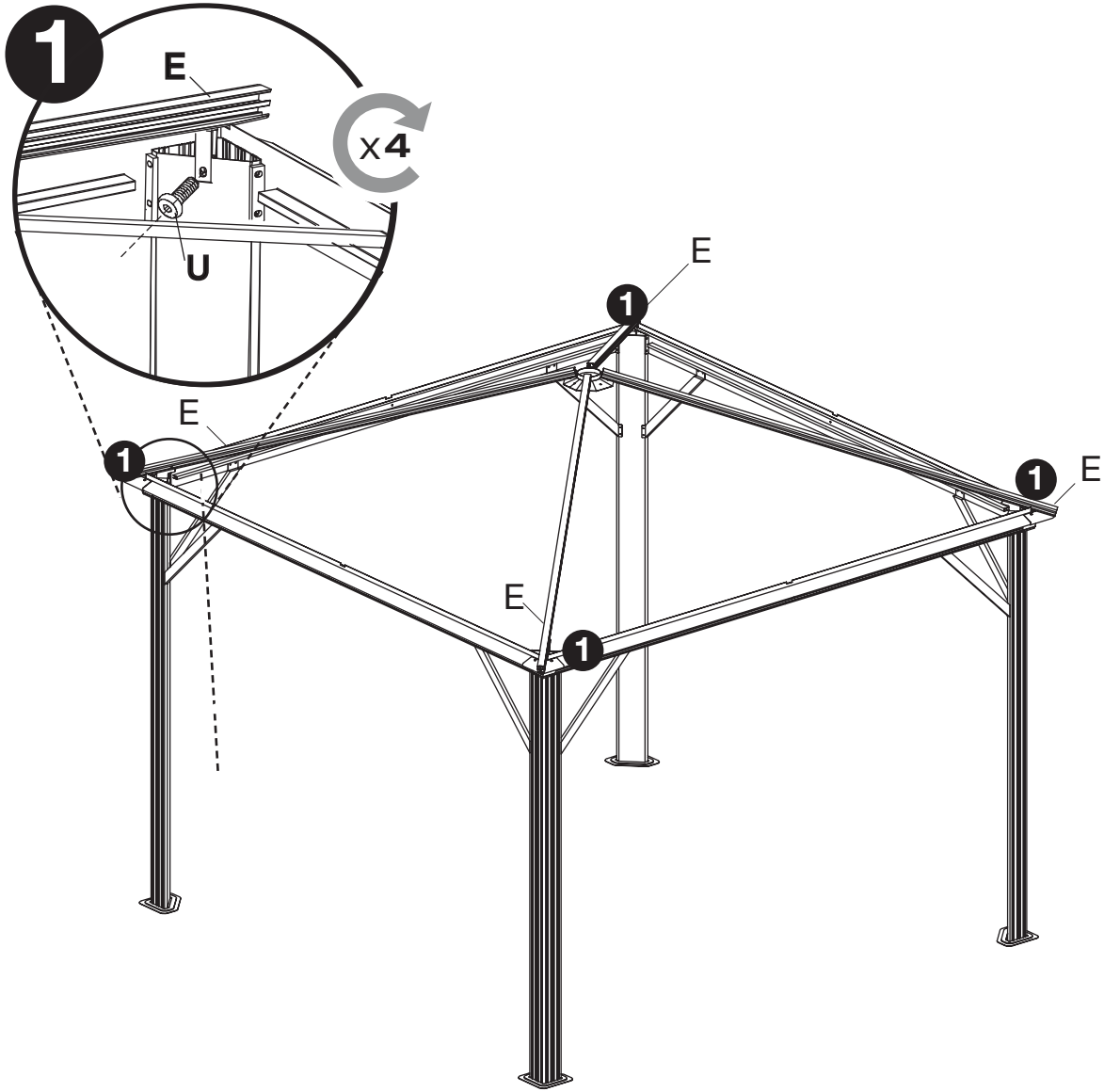

Ux4

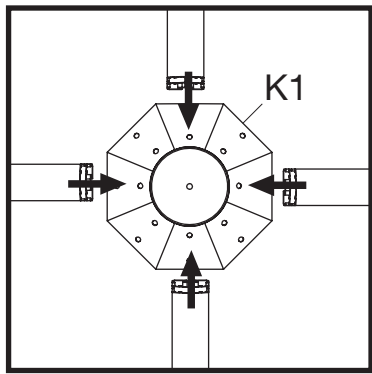
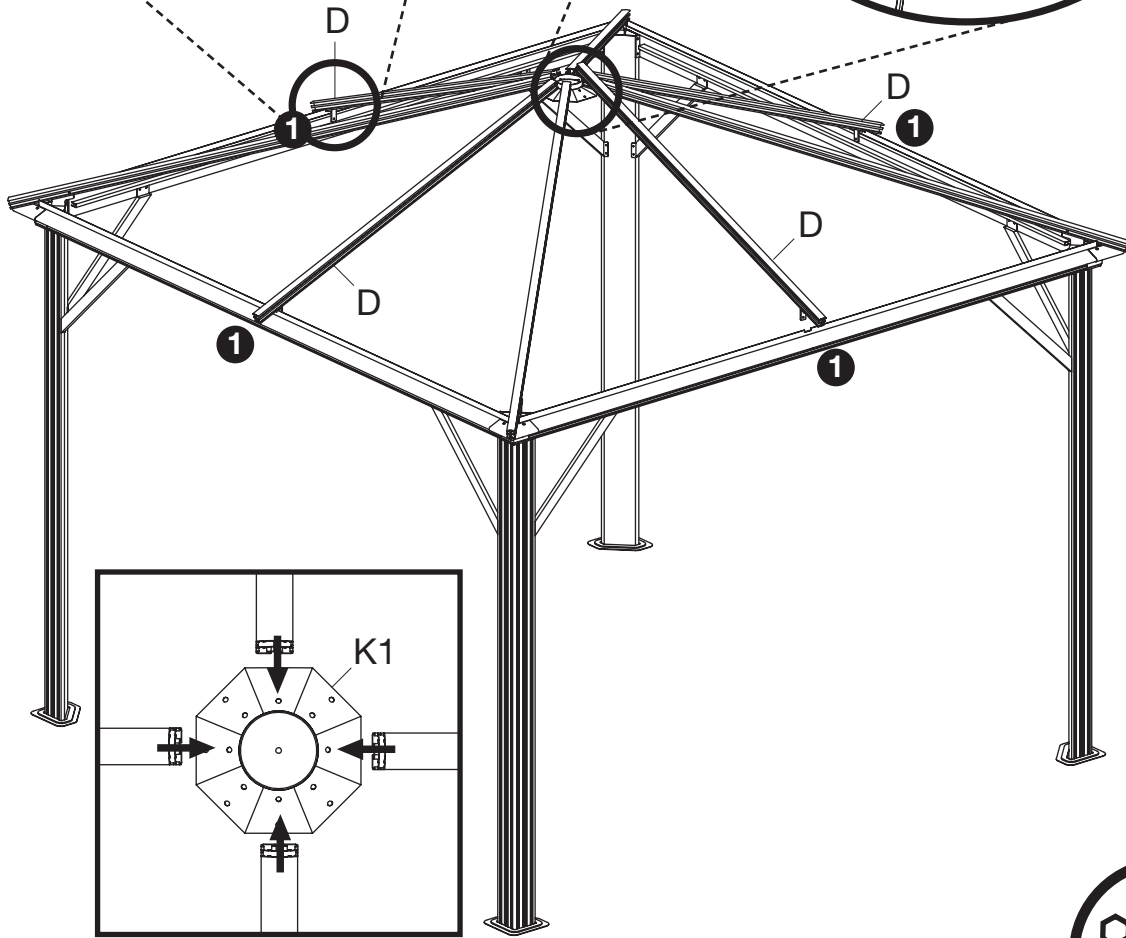
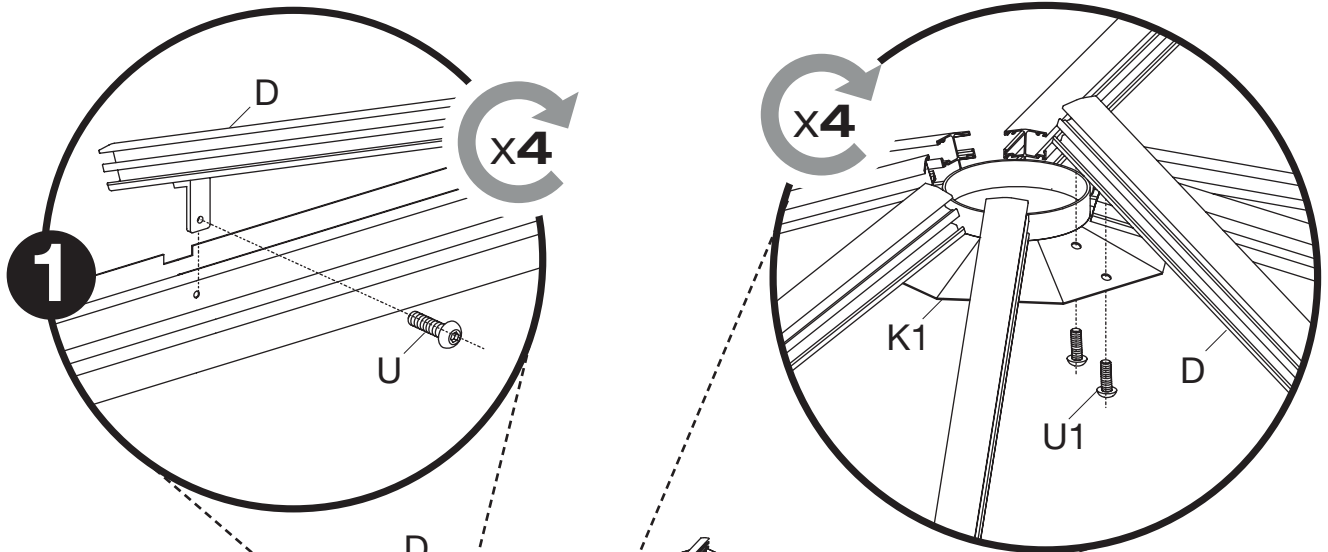

Dx4

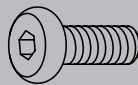

Ux4

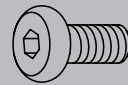

U1x8

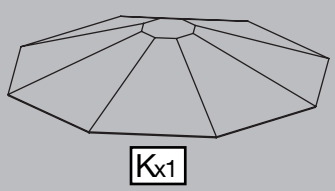
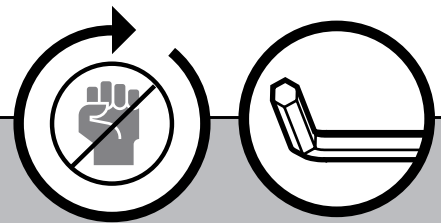
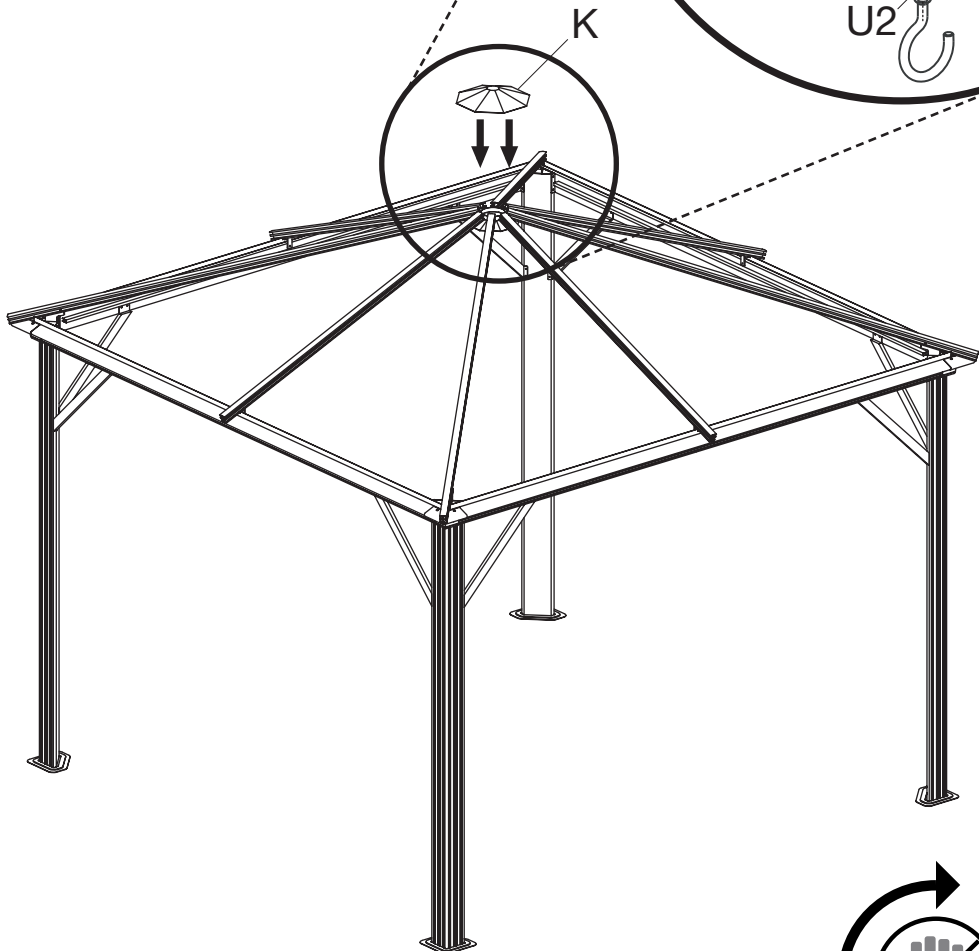
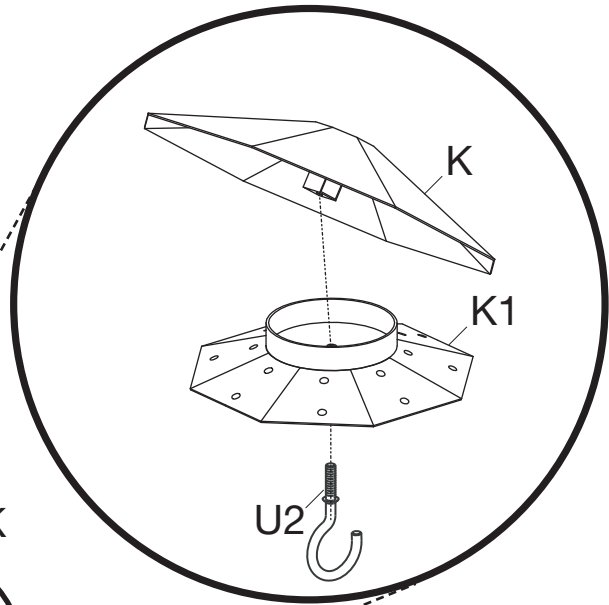

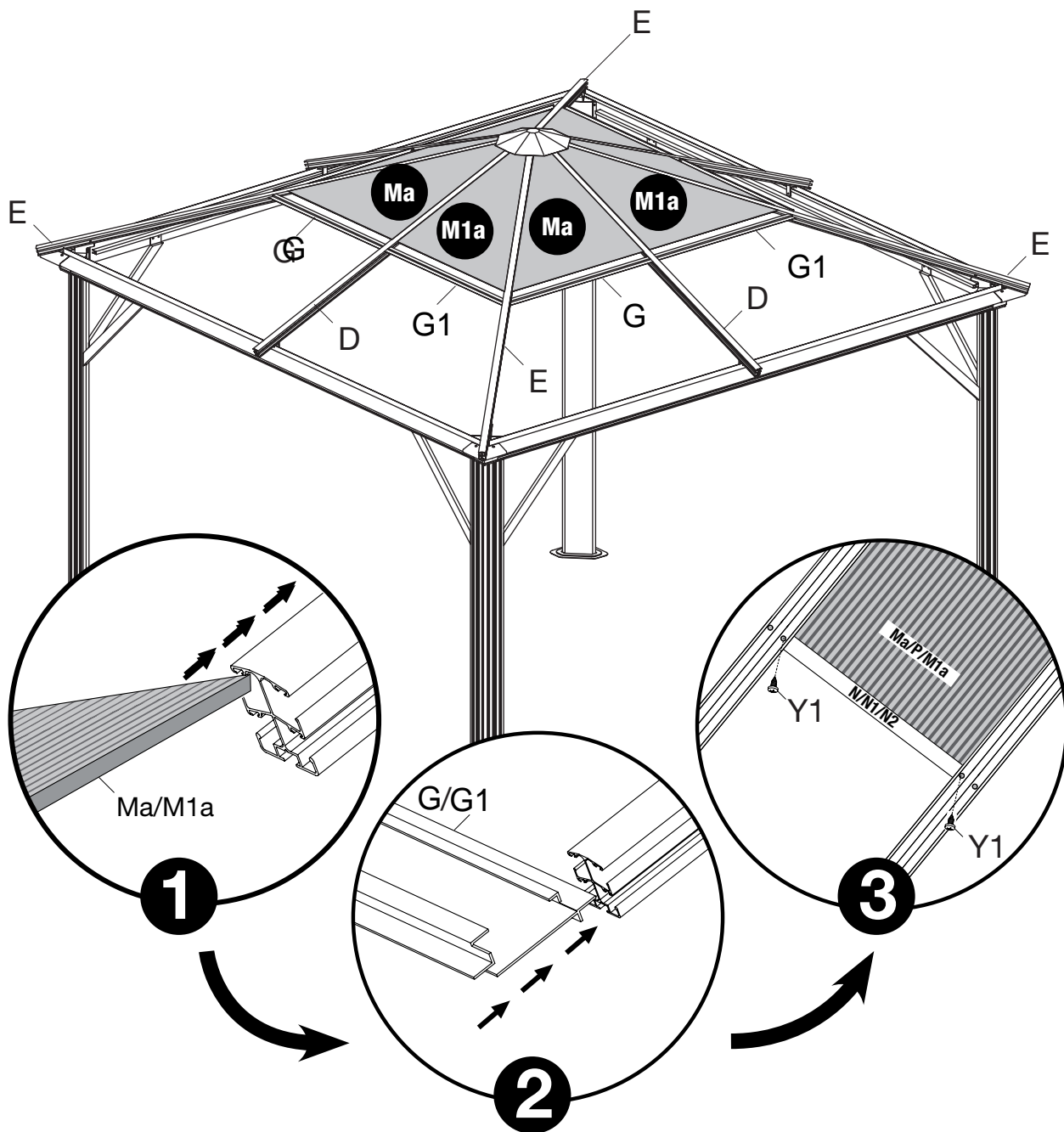

A parts list and safety icon are located at the bottom of the page. The parts list includes:

- Ma x4 (triangular panel)
- M1a x4 (triangular panel)
- Y1 x16 (screw)
- G x4 (rib)
- G1 x4 (rib)

A safety icon of a pair of hands is also present.



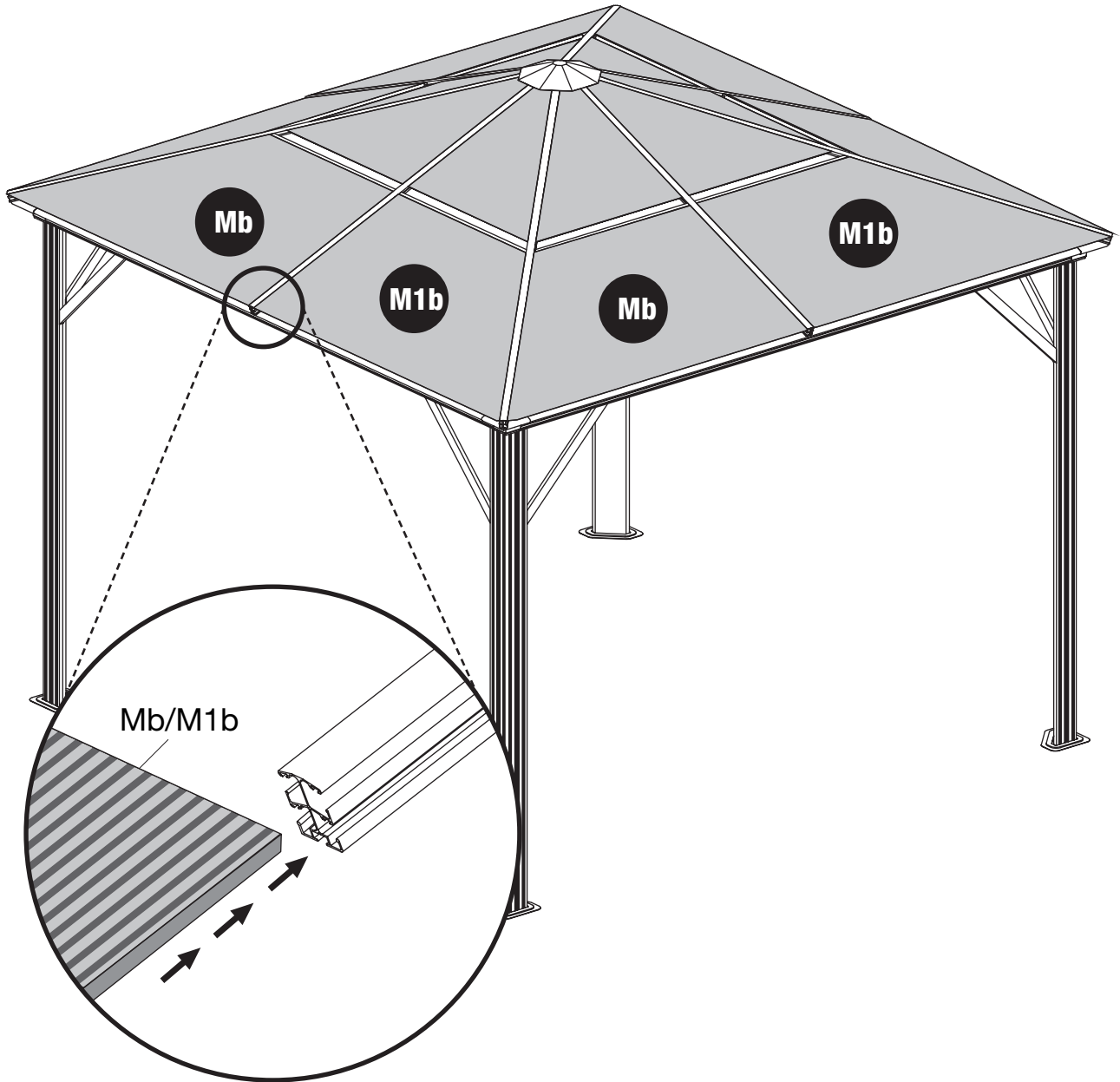



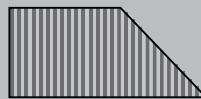



**Mb<sub>x4</sub>**

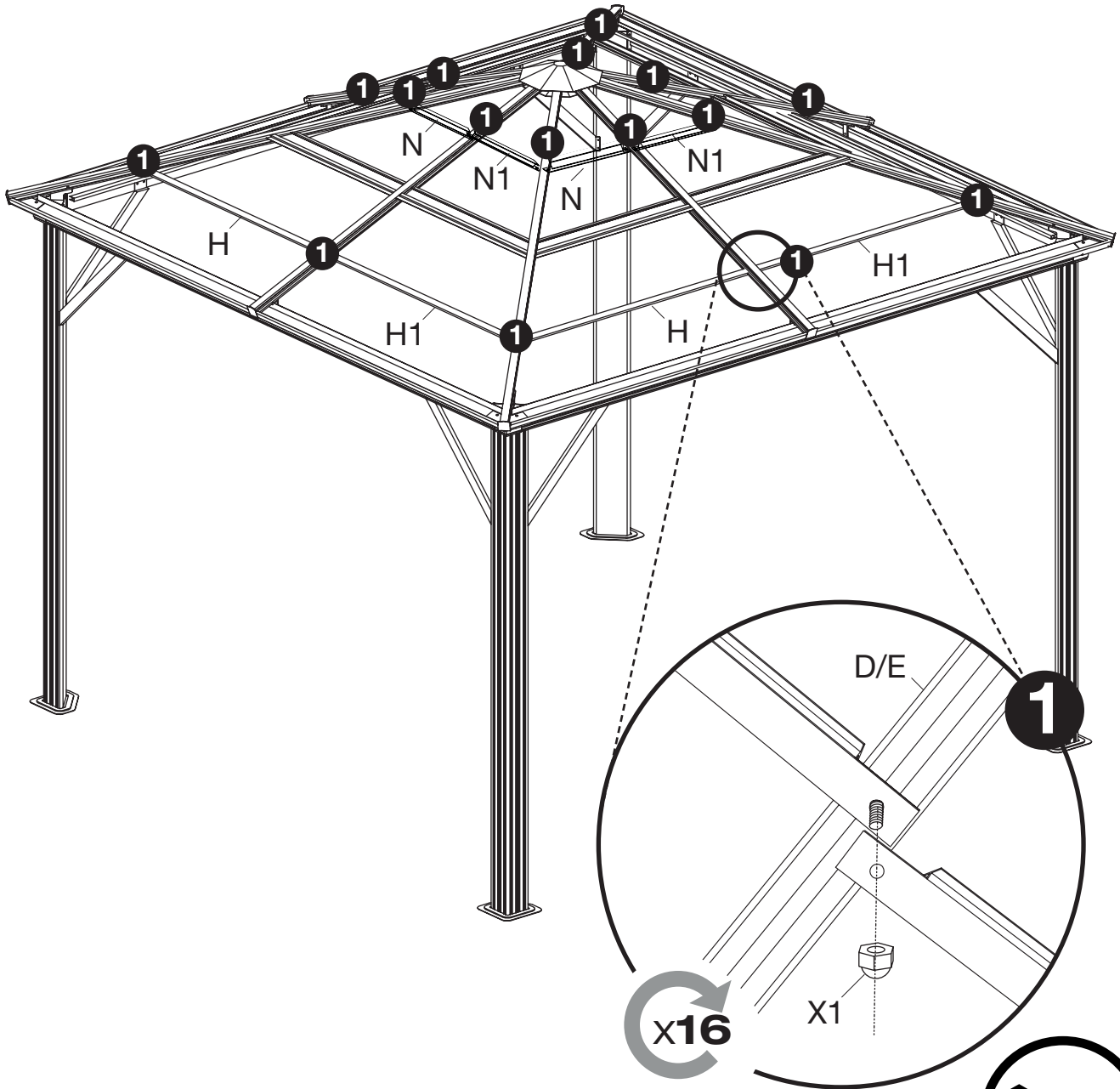

**M1b<sub>x4</sub>**





 Hx4	 X1x16	 Nx4
 H1x4		 N1x4

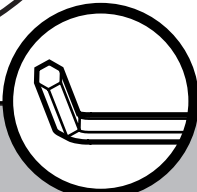

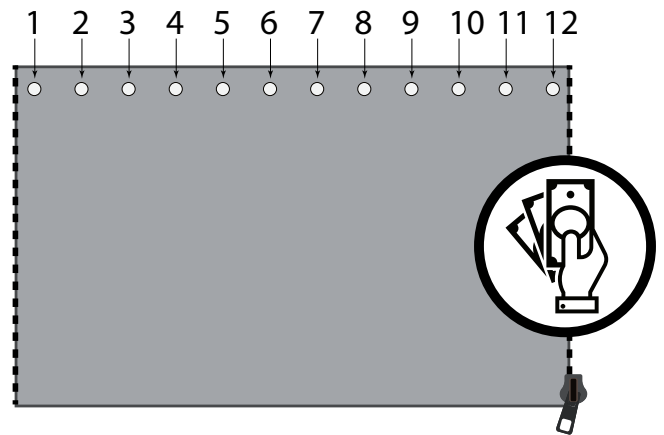
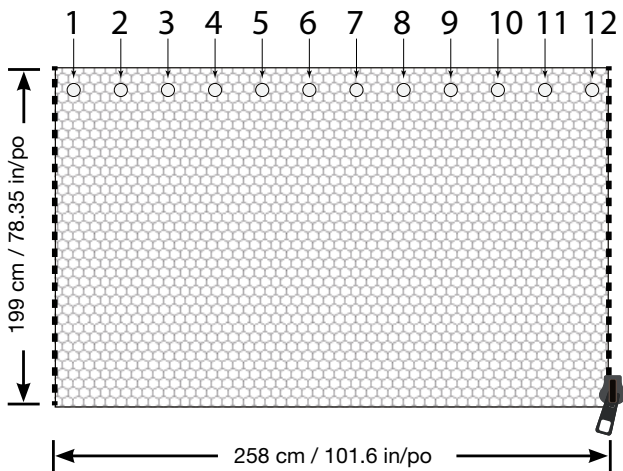
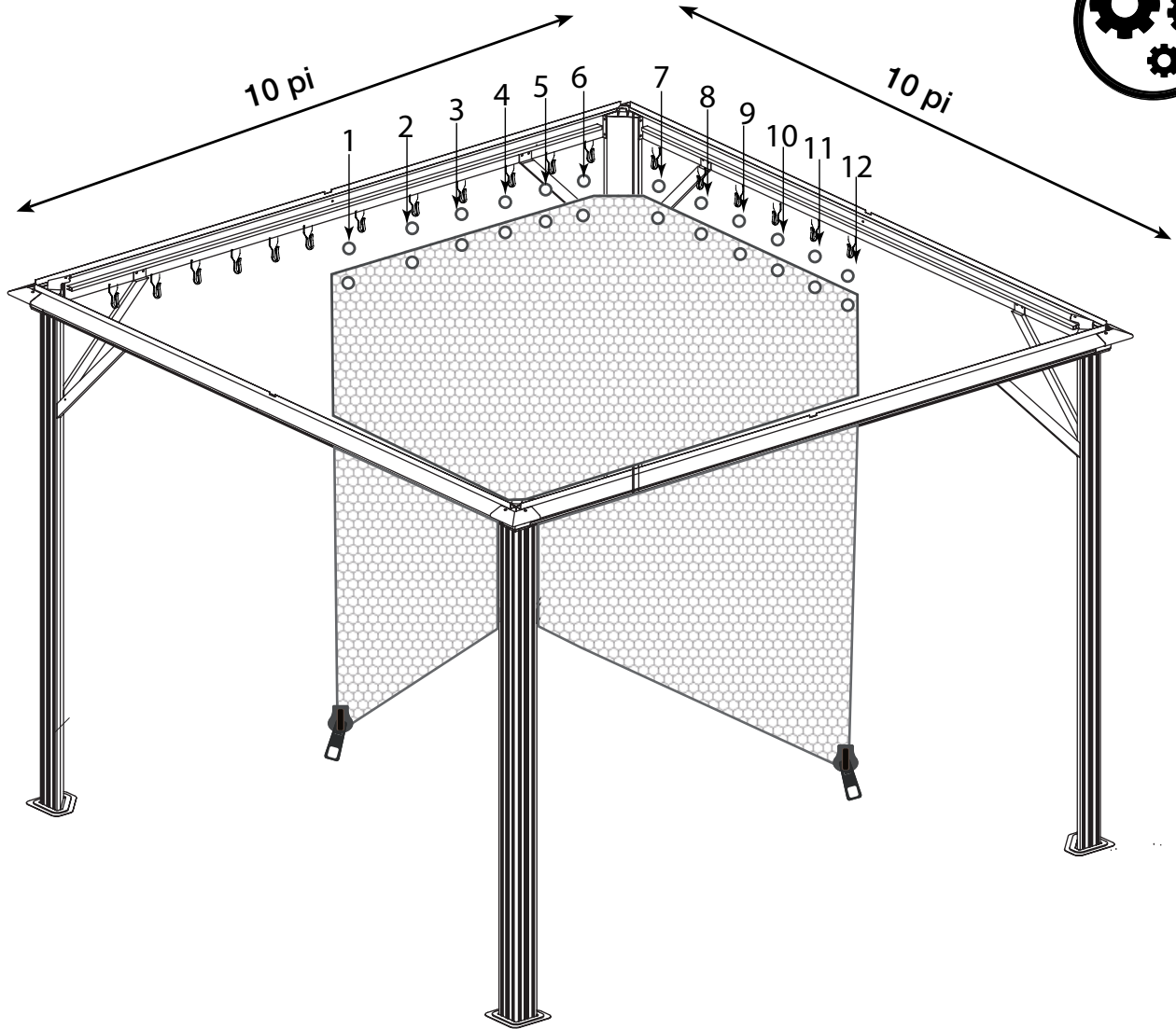



**SOJAG** ■ I  
produits saisonniers • seasonal products