

SOJAG

produits saisonniers • seasonal products

QUESTIONS? 1-866-901-1649

Assembly Manual / Guide d'assemblage / Manual de ensamblaje / 조립설명서 / Montageanleitung

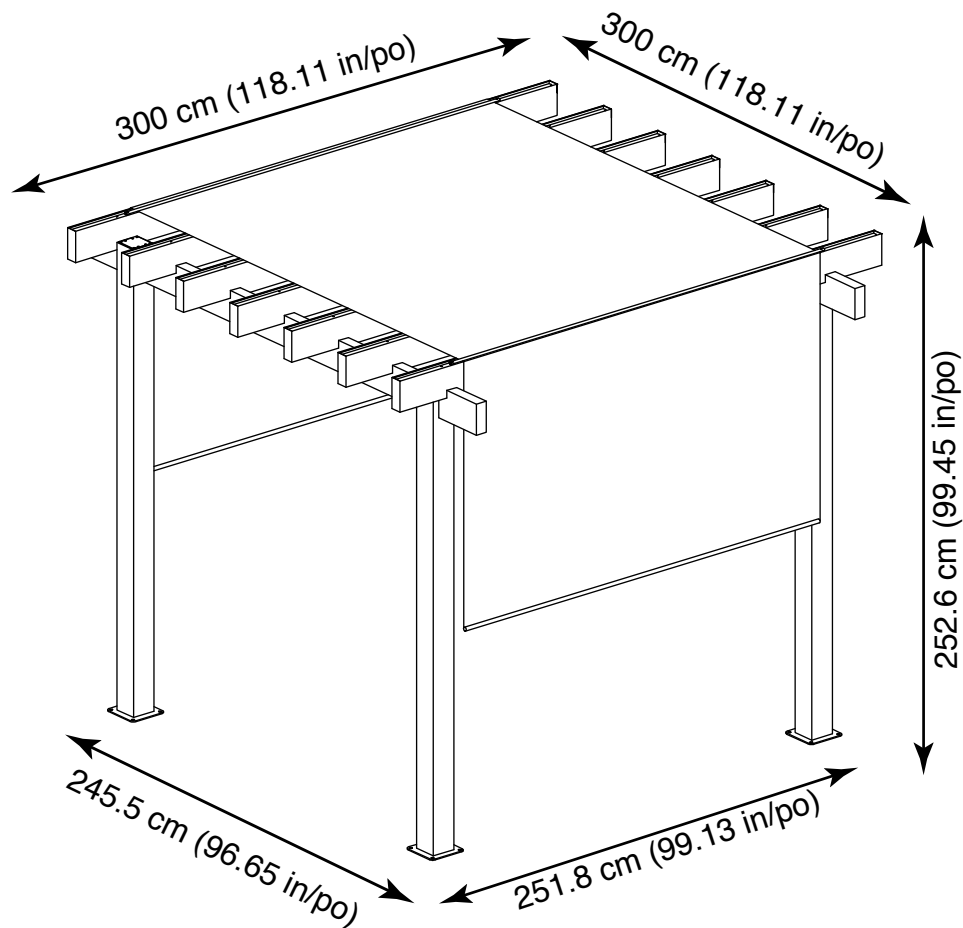

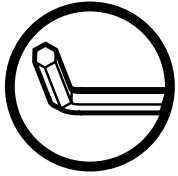

Use the hex keys in the box. / Utilisez les clés hexagonales fournies dans la boîte. / Utilice las llaves hexagonales en la caja. / 상자에 육각 키를 사용 하십시오. / Verwenden Sie die Sechskantschlüssel in der Box.

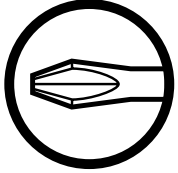

Please use a Phillips screwdriver. / Utilisez un tournevis de type Phillips / Por favor, use un destornillador Phillips. / 십자 드라이버를 사용 하십시오. / Bitte verwenden Sie einen Kreuzschraubenzieher.



You may need to use a drill for this step. / Vous pouvez avoir besoin d'utiliser une perceuse pour cette étape. / Puede que tenga que utilizar un taladro para este paso. / 이 단계에선 드릴을 사용해야 할 수도 있습니다. / Für diesen Schritt können Sie einen Bohrer verwenden.



Wearing protective gloves is recommended. / Le port de gants de protection est recommandé / El uso de guantes de protección se recomienda. / 보호 장갑을 착용 하는 것이 좋습니다. / Das Tragen von Schutzhandschuhen wird empfohlen.



Two or more people are required at this stage. / Deux personnes ou plus sont nécessaires à cette étape. / Dos o más personas se requieren en esta etapa. / 이 단계에서는 두 명 이상이 필요합니다. / Für diesen Bauschritt sind 2 oder mehr Personen erforderlich.



Do not tighten screws all the way for now. / Ne pas visser fermement pour l'instant. / No atornille con firmeza por ahora. / 아직 나사를 단단히 조이지 마십시오. / Bitte die Schrauben zum jetzigen Zeitpunkt noch nicht fest anziehen.



Sold separately. / Vendus séparément. / vendido en las opciones. / 옵션 판매 / Optional erhältlich



Optional step / Étape optionnelle / Paso opcional / 선택적 단계 / Optionaler Schritt

V X 224(+10)

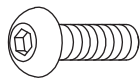

U X 28(+3)

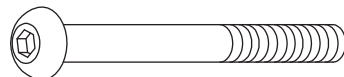

U1 X 4(+1)

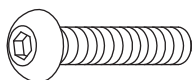

S X 16(+1)



P X 4(+1)



Z X 1

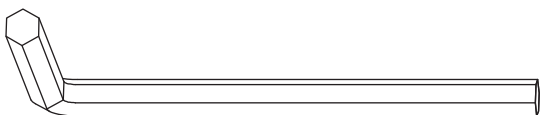

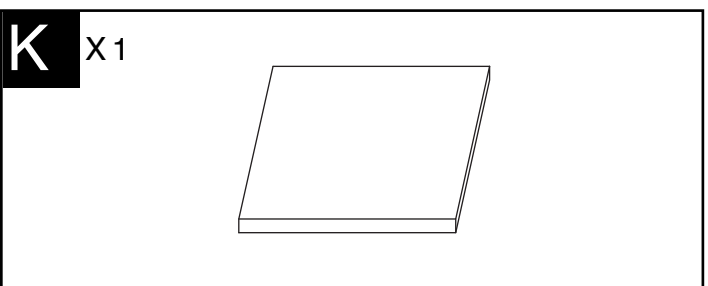
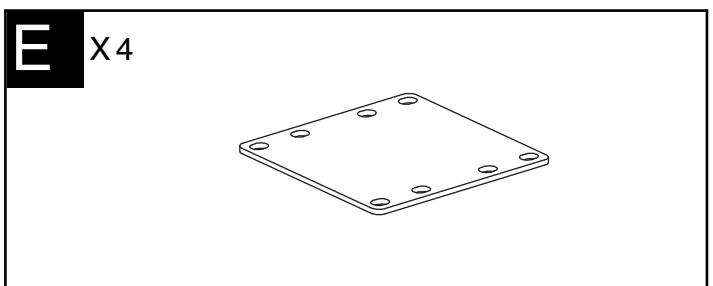
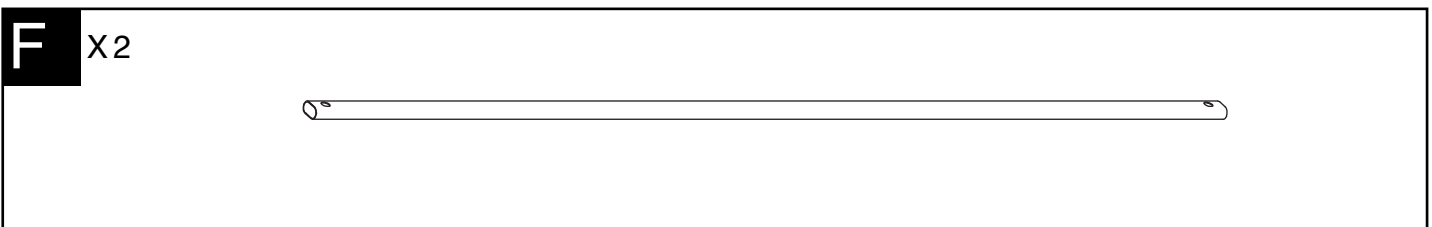
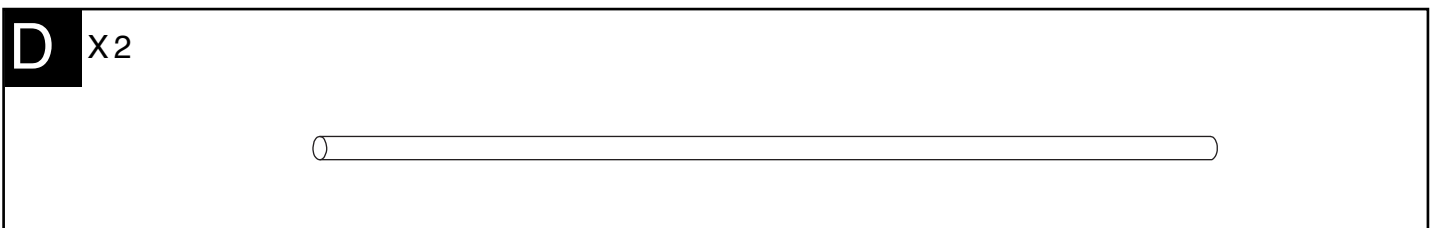
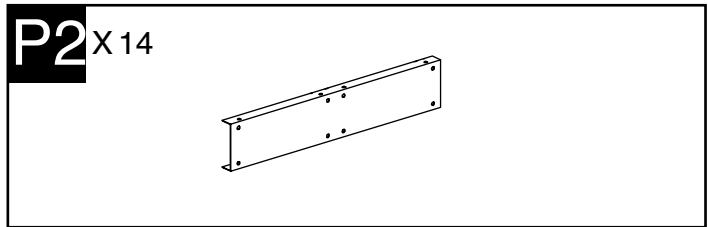
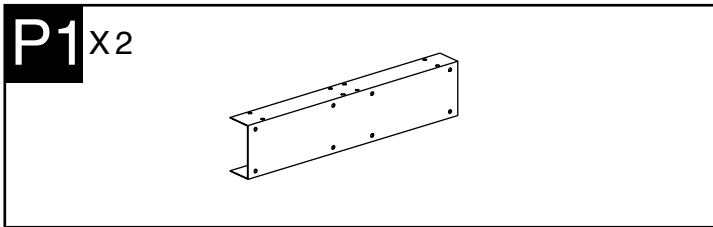
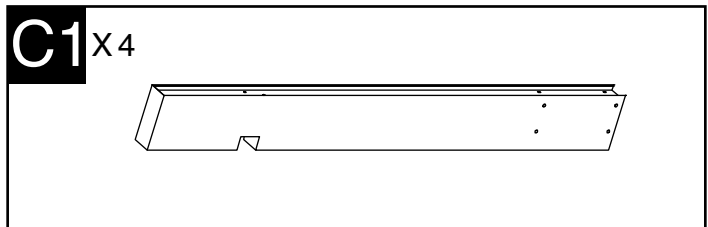
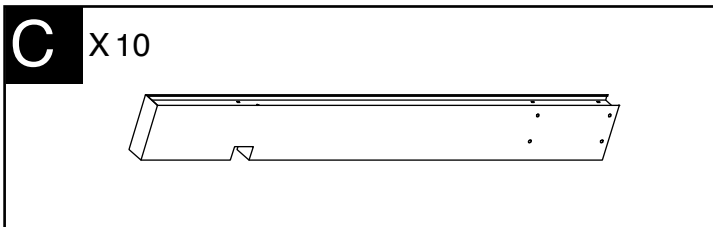
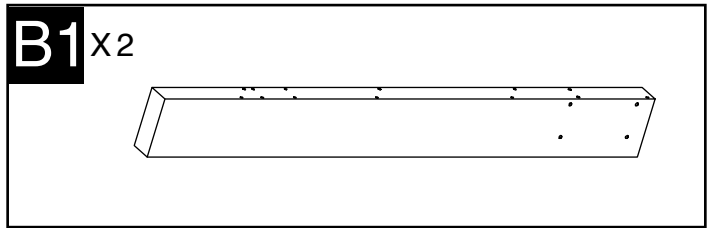
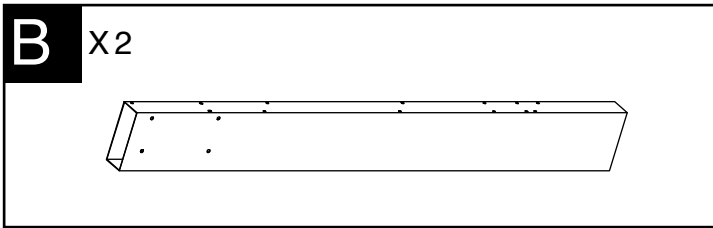
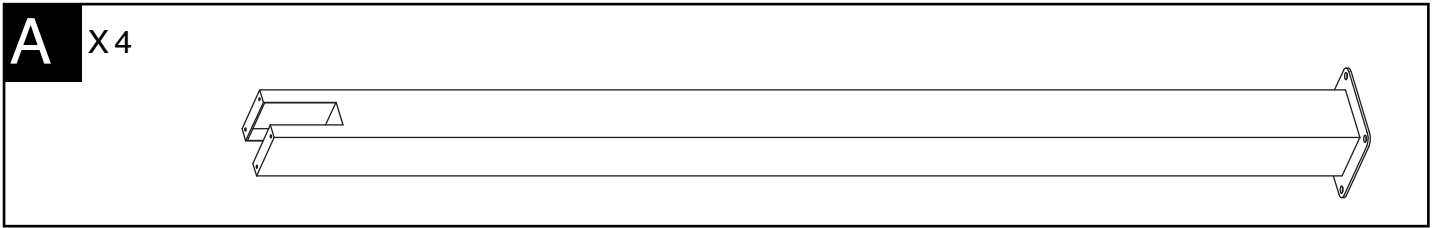

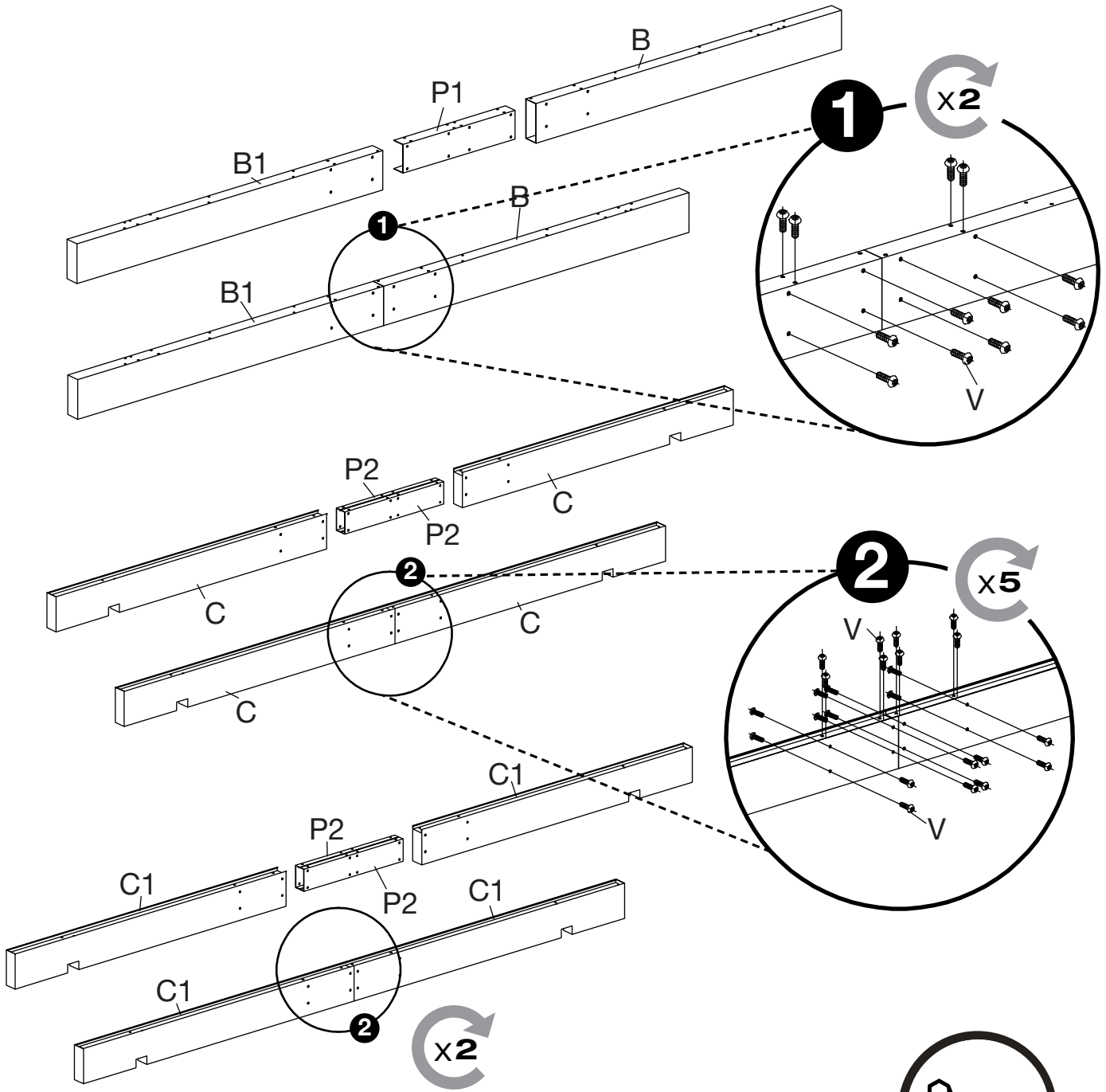

This section contains the parts list for the assembly. It includes illustrations of the following components:

- Bx2**: Two long horizontal bars with a top flange.
- Cx10**: Ten long horizontal bars with a top flange and a notch on the bottom edge.
- B1x2**: Two long horizontal bars with a top flange.
- C1x4**: Four long horizontal bars with a top flange and a notch on the bottom edge.
- P1x2**: Two short horizontal bars with a top flange.
- P2x14**: Fourteen short horizontal bars with a top flange.
- Vx192**: One screw with a hexagonal head and a threaded shaft.

A circular icon in the top right corner of this section shows a corner bracket.

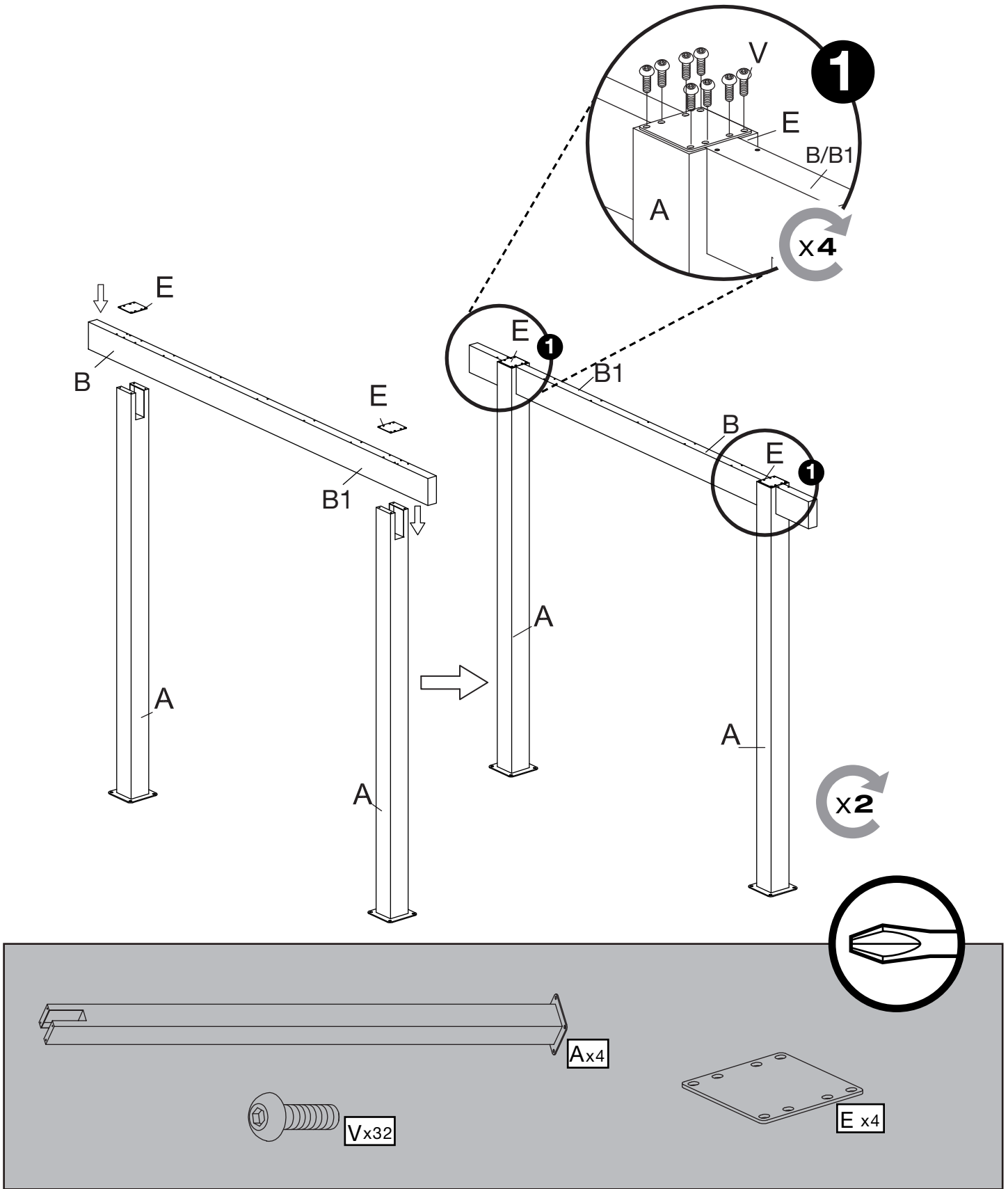

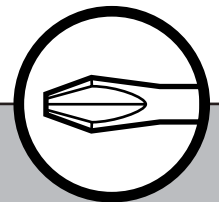
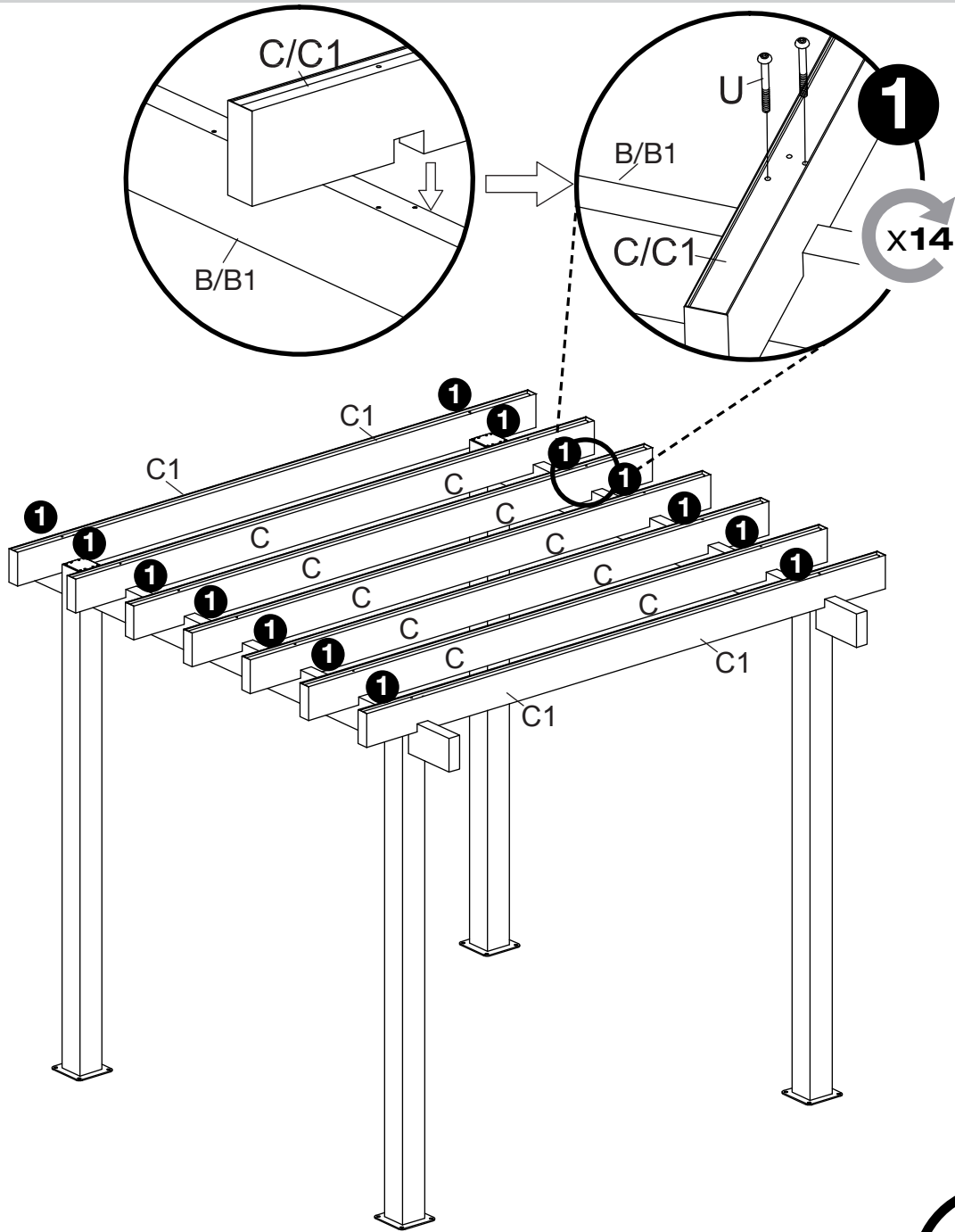

Ux28

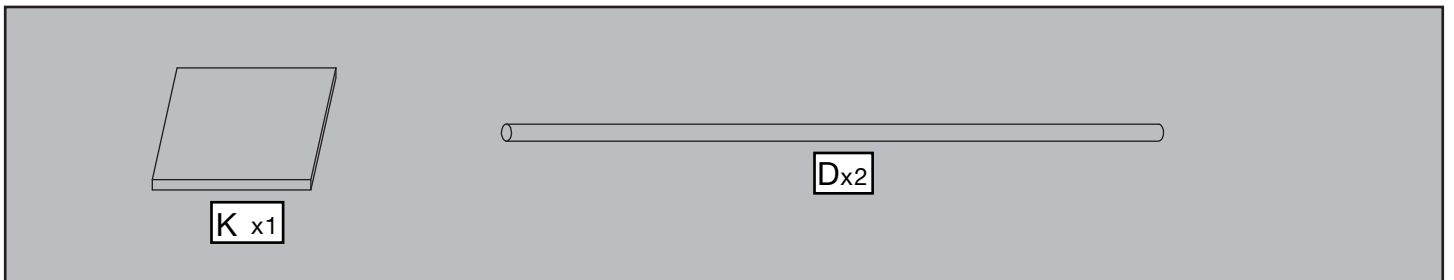
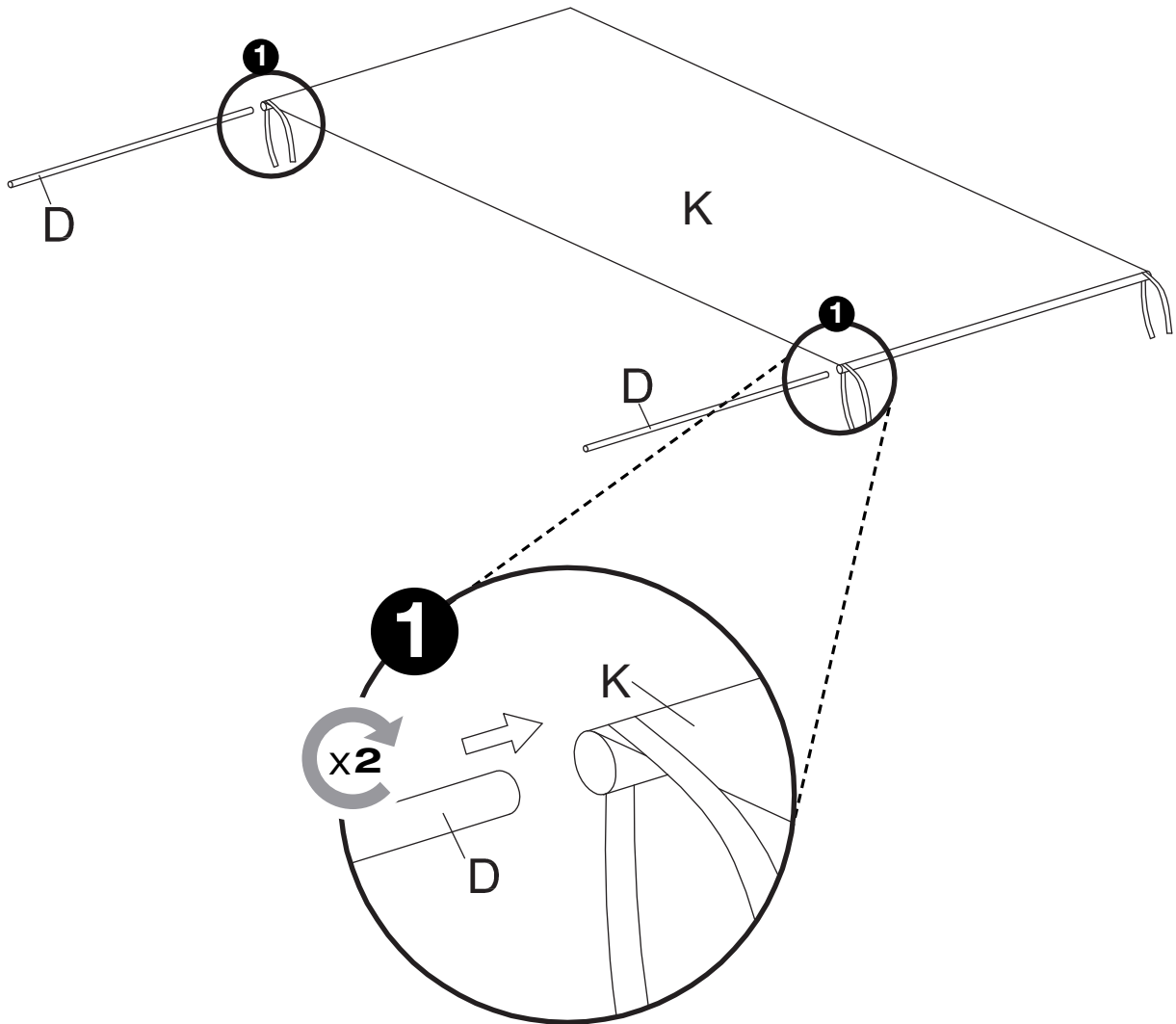

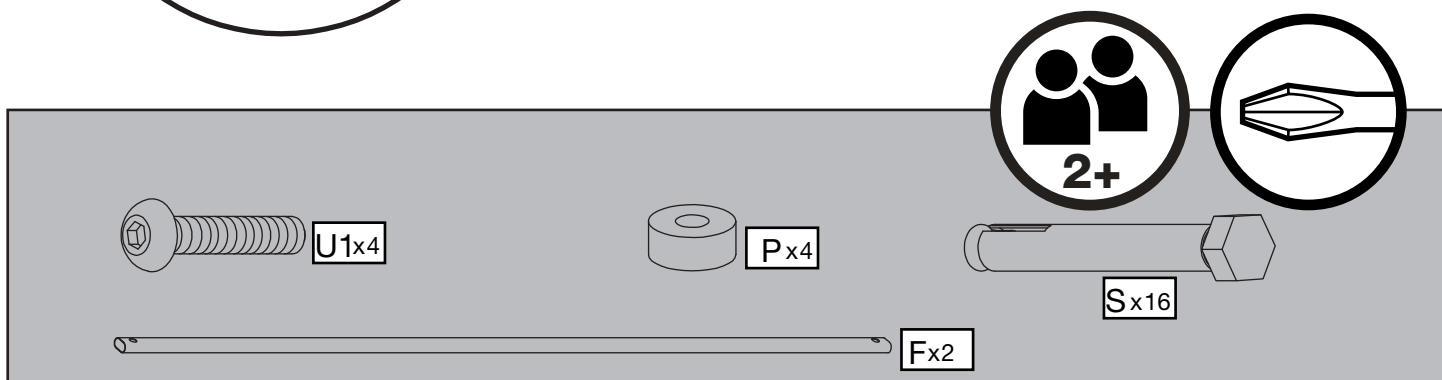
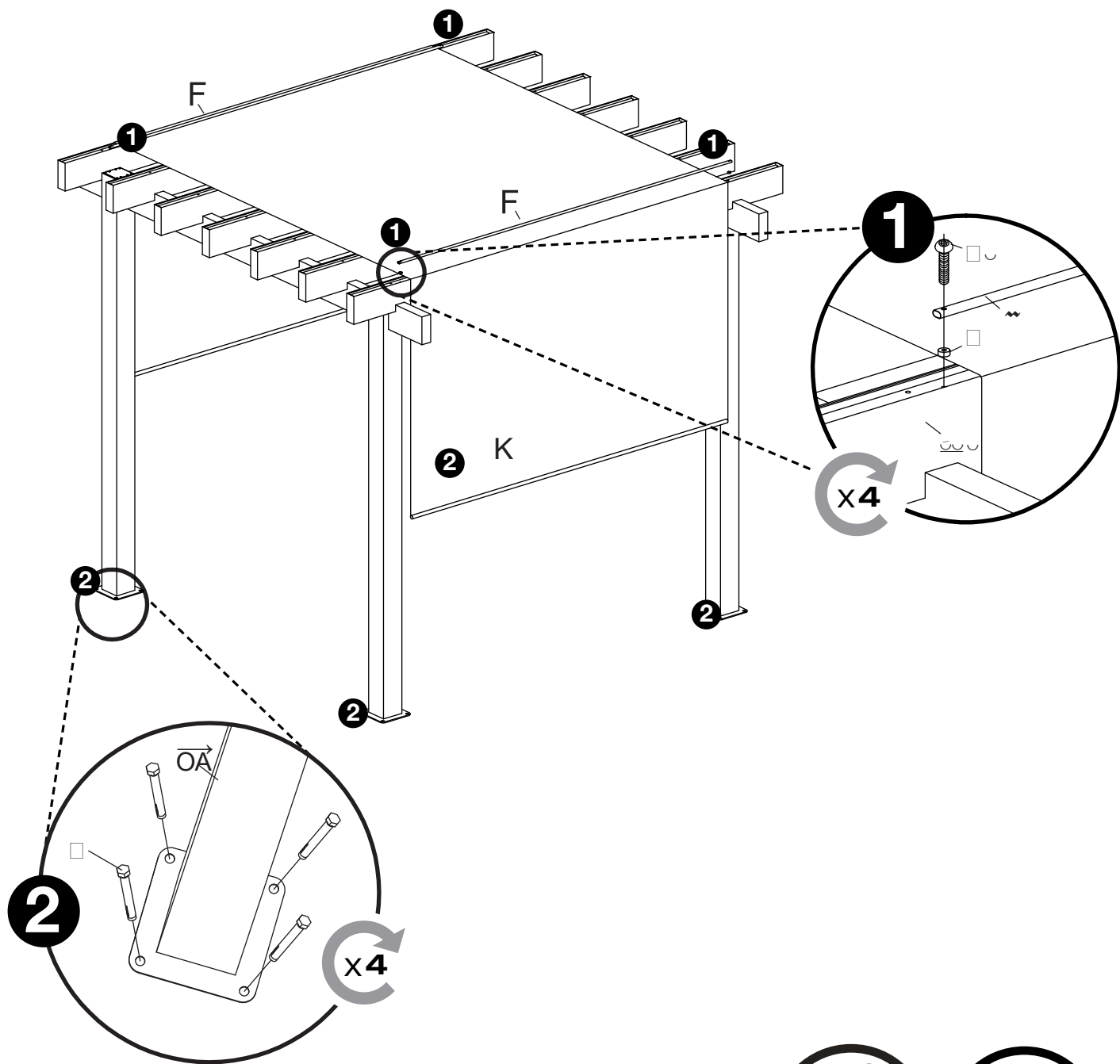

SOJAG ■ I
produits saisonniers • seasonal products