

ASSEMBLY MANUAL
B100 105cc

GAS POWERED MINIBIKE



POWERSPORTS



POWERSPORTS

4120 E. Scyene Road, Mesquite, Texas 75181

champmoto.com



CAUTION

This Minibike was shipped without engine oil. Always fill with the correct amount and grade of engine oil as listed in the owner's manual.

⚠️ WARNING

NEVER ATTEMPT TO START THIS MINIBIKE WITHOUT READING AND UNDERSTANDING THE OWNER'S / OPERATOR'S MANUAL. THE OWNER'S OPERATOR'S MANUAL PROVIDES INFORMATION ON SAFETY, PARTS, FUNCTIONS, PRE-RIDE INSPECTION, STARTING AND MAINTENANCE

Provincial/Municipal governments have different regulations pertaining to owning and operating an off-road vehicle, learn the regulations in your area.

4120 E. Scyene Road, Mesquite, Texas 75181
champmoto.com



@colemanpowersportsusa



@colemanpowersports_usa



Coleman Powersports

PRE-RIDE INSPECTION

Inspecting and checking the condition of the Mini Bike before each ride is important. Following the pre-ride check list will help insure there are no problems which could result in injury or becoming stranded. Make sure the Mini Bike is in good operating condition before each ride.

⚠ WARNING

Failing to inspect and maintain the Mini Bike could be hazardous.

Not following the pre-ride inspection procedures could result in losing control of the Mini Bike resulting in an accident or damage to the Mini Bike

Always perform a Pre-ride inspection before each ride.

⚠ WARNING

Performing maintenance and checks while the engine is running could be hazardous.

You could be severely injured by moving parts or hot surfaces.

Never perform maintenance or check procedures while the engine is running with the exception of checking the engine stop switch or throttle.

WHAT TO CHECK	CHECK FOR
Steering	<ul style="list-style-type: none"> • Smoothness • No restriction of movement
Brakes	<ul style="list-style-type: none"> • Proper brake lever play
Tires	<ul style="list-style-type: none"> • Proper tire pressure
Fuel Tank	<ul style="list-style-type: none"> • Enough fuel for the ride • Fuel cap secure • Hoses have no signs of cracks or leaks
Throttle grip	<ul style="list-style-type: none"> • Throttle grip snaps back to idle when released • Operates freely • Has correct free play
Engine Stop Switch	<ul style="list-style-type: none"> • Switch shuts off engine when activated.
Engine Oil	<ul style="list-style-type: none"> • Correct oil level
Drive Chain	<ul style="list-style-type: none"> • Proper tension • Lubricated
General Condition	<ul style="list-style-type: none"> • Axle nuts tight • All nuts and bolts tight • No rattles from engine or frame while running

STARTING ENGINE

STARTING ENGINE

To start the engine

1. Place the fuel valve (1) in the "ON" (forward) position.
2. If engine is cold, place the choke lever (2) in the "ON" right position.
3. Place the ON/OFF switch (3), located on the handlebars, in the (on)position.
4. Pull the starter recoil cord (4) to start the engine.
5. Once engine has warmed up for a few minutes, place the choke lever (2) back to the "OFF" (left) position.

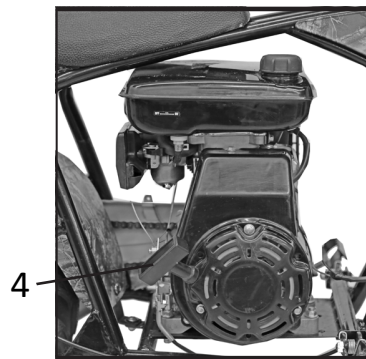
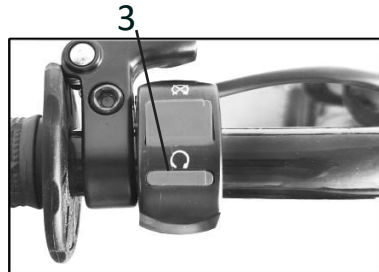

⚠ WARNING

Starting or running the Mini Bike in an enclosed area such as a garage or shed where there is no ventilation is hazardous

Inhaling exhaust fumes from the Mini Bike can cause severe injury or death

Never start or run the Mini Bike in an in closed environment where there is no ventilation. Always start and run outdoors.

PARTS

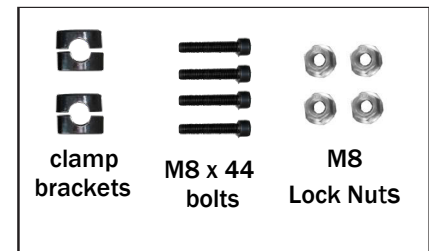
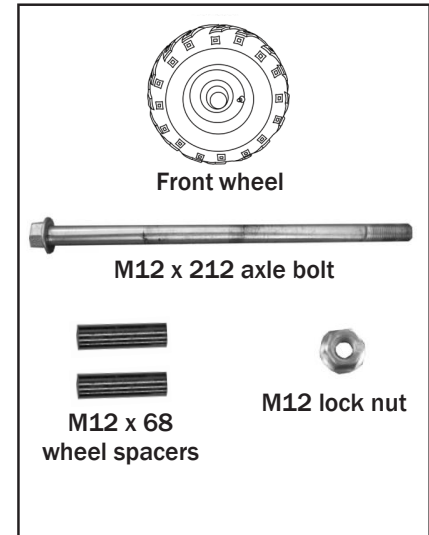
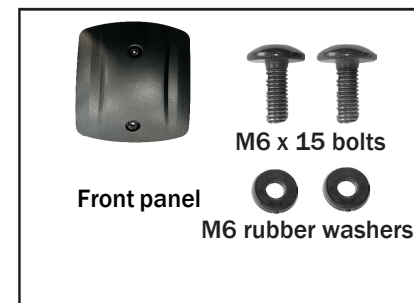
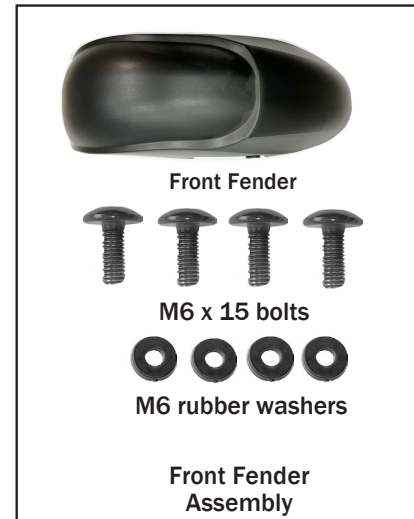
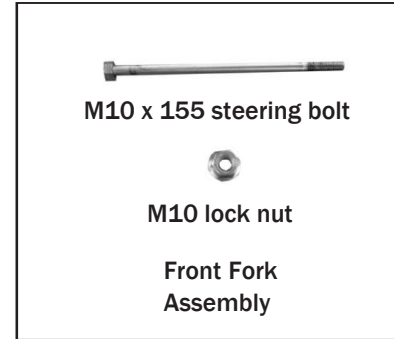

THROTTLE ADJUSTMENT

FRONT FORK INSTALLATION

Tools Needed

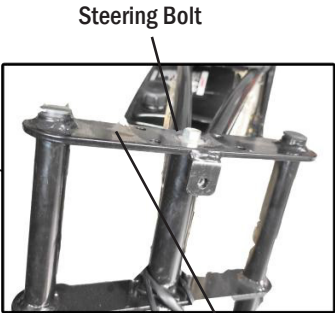
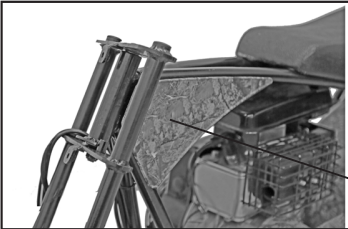
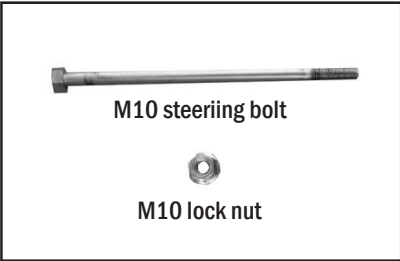
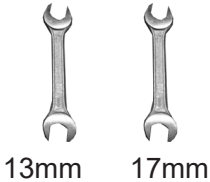

Steering Neck Top Bracket

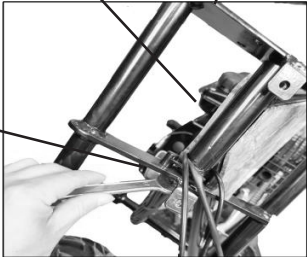

Lock Nut

1. Install front Fork by inserting the M10 steering bolt through the top bracket of the forks, steering neck and bottom bracket of forks.

Secure with M10 lock nut

Note: Do not over tighten lock nut.

Throttle Cable adjustment

It is important that the throttle grip have a certain amount of free play .

The hand grip throttle free play (1) should be .078 - .24 in (2-6 mm)

To adjust free-play

1. Loosen jam nut (2)
2. Turn adjusting nut (3) to proper setting
3. Once throttle grip is at the proper free-play, re-tighten the jam nut (2).

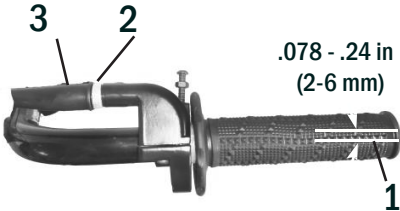

BRAKE ADJUSTMENT

Brakes

Brake Lever Adjustment

The front left brake lever (1) should have 2.0 - 4.0mm (0.08 - 0.16) of free play.

To adjust brake lever free play:

1. Loosen the jam nut (2) on the brake cable.
2. Turn the adjuster nut (3) until the correct amount of free-play is achieved.
3. Re tighten jam nut (2)

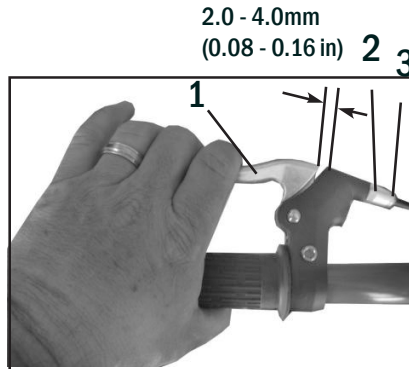

Brake Adjustment

The brake adjustment (4) is located on the rear brake caliper assembly.

To adjust brakes, turn the adjusting bolts (4) clockwise to increase braking, counter clockwise to decrease braking. Increase the tension of the brake cable by pulling cable tighter by loosening nut (5) and pulling cable (6) tighter. Once tightened make sure to re tighten nut (5)

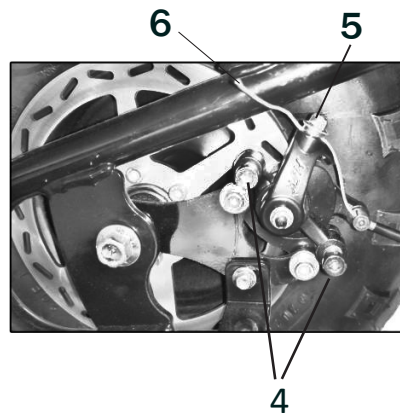

FRONT FENDER INSTALLATION

Tools Needed



5mm Allen Wrench

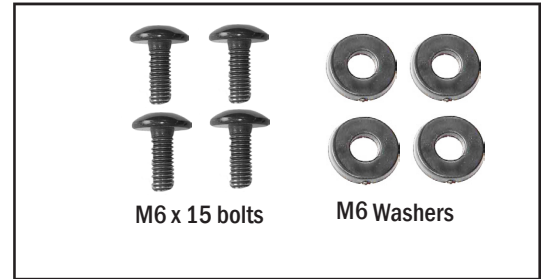

1. Attach front fender with M6 x 15 screws, M6 rubber washers.

Note: Long portion of the fender faces forward

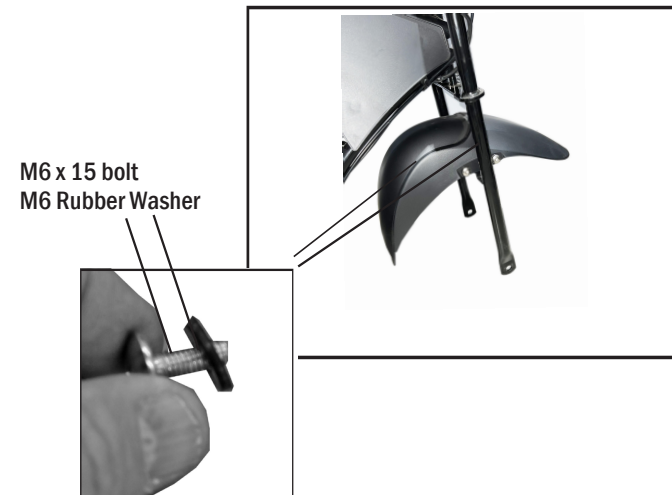

FRONT WHEEL INSTALLATION

Tools Needed

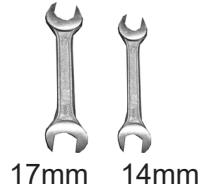

1. Orient the front tire so the tread pattern on the tire faces forward when looking from the top.

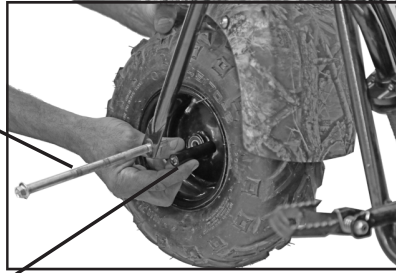

2. Insert M12 axle bolt through the fork assembly in the following order: fork, M12 spacer, wheel, M12 spacer, fork

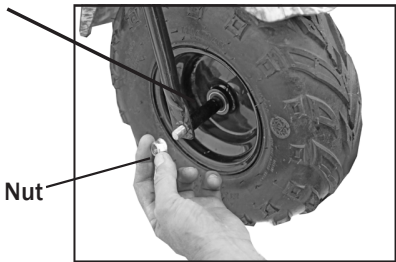

3. Install M12 lock nut and tighten snug

Note: Do not over tighten lock nut. Over tightening lock nut could damage wheel bearings



TIRE PRESSURE

Tires

1. Check tire pressure. Incorrect tire pressure can affect the handling, rider comfort, steering, tire life and traction. Always check the tire pressure before each ride.



Tire pressure

Front tires: 5psi

Rear tires: 5psi

1/2 - 3/4 in.
(15-20mm)

Chain tension

Check the tension of the chain, The chain (1) tension should be 1/2 - 3/4 in. (15-20mm)

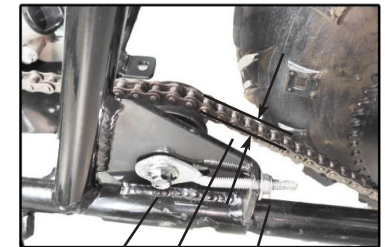

Chain tension (slack) adjustment

1. Loosen bolt on chain tensioner (2).
2. Move Tensioner right to tighten chain or left to loosen chain using cinch nut (3).

3. If chain needs more tightening after adjustment, loosen the 4 bolts (4) on the bottom of the engine plate and move engine forward.

Note: Make sure chain is in line with sprockets after adjustment

4. Re-check chain tension.

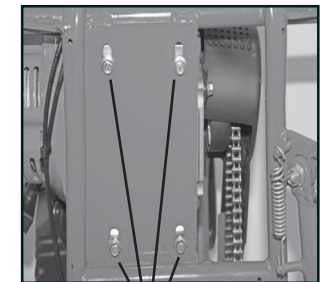

4

OIL AND FUEL

Engine Oil

Mini bike **DOES NOT** have oil in crankcase when shipped from the factory.

NEVER ATTEMPT to start the engine without engine oil.

Filling with Oil

1. Remove the oil fill plug (1)
2. Fill with SF15W-40 motor oil. This mini bike takes .32qt. (.3L) of engine oil. Oil should be up to the brim of the fill hole.
3. Re- install fill cap, Start engine and allow to run for a few minutes, Re-check oil level and fill accordingly.

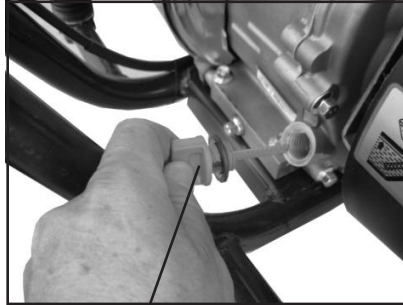

1



Caution: Do not over or under fill with Motor Oil

FUEL

Never use leaded gasoline in this product. It could affect the engine's emissions and damage the engine.

Mini Bike requires clean unleaded regular gasoline with a minimum octane rating of 86 or higher.

Fill with gasoline up to the bottom of the filler neck.

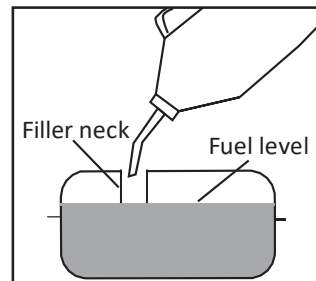

HANDLEBAR INSTALLATION

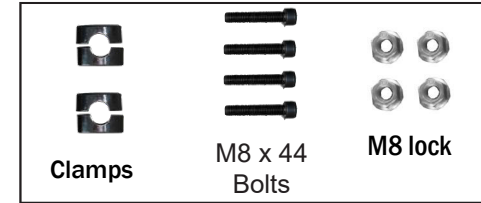

1. Place handlebars on top of fork assembly with 2 of the clamps between the handlebars and top of forks.

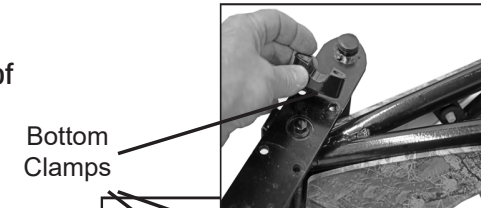

Bottom Clamps

Handlebars

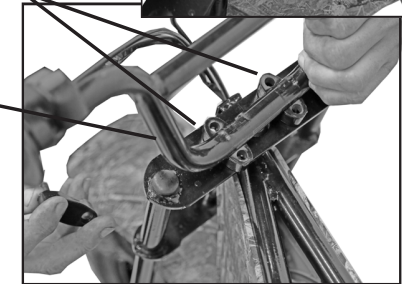

Top Clamps

M8 x 44 Bolts

2. Place the 2 remaining clamps on the top of handlebars and fasten down with M8 x 44 bolts and M8 lock nuts.



NOTE: Do not tighten bolts down tight until all bolts are in place and handlebars are adjusted to the desired position for the rider.



FRONT PLATE INSTALLATION

Tools Needed



5mm Allen Wrench



M6 x 15 bolts



M6 rubber washers

M6 x 15 bolt
M6 Rubber Washer

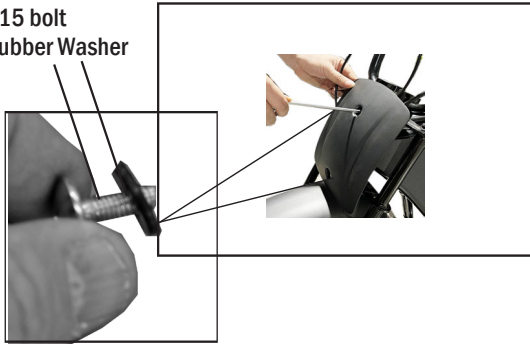

SECURE WIRES AND CABLES



Cable Ties

1. Make sure the On/Off Switch wire, Throttle cable and Brake cable are not kinked and have free movement when the handle bars are turned from left to right.

2. Secure wires and cables to frame using the cable ties provided.

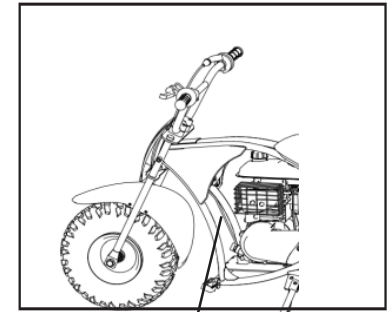

Cable Ties

CLUTCH COVER INSTALL

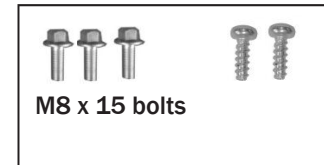

M8 x 15 bolts

1. Install clutch cover over the 3 bracket tabs provided on the clutch assembly. Make sure the clutch cover is attached securely.



M8 x 15
Axle bolt

