







ASSEMBLY INSTRUCTION

DDP-1866L

- A**  3.5x60=28x
- B**  3.5x50=76x
- C**  3.5x40=16x
- D**  3.5x30=8x
- E**  3.0x16=8x
- L**  =2x

PARTS

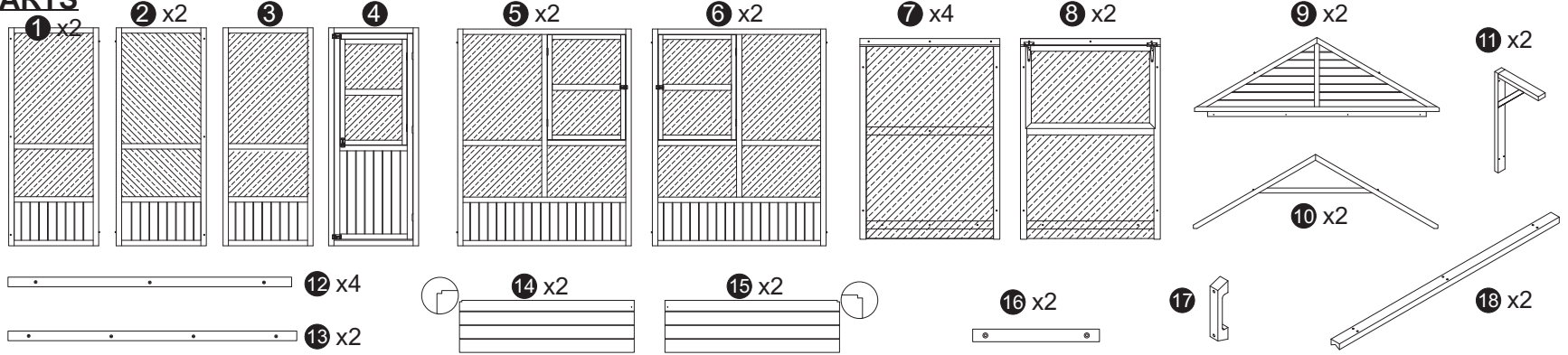

ASSEMBLY

