







# ASSEMBLY INSTRUCTION

DDP-1708B

- A  3.5x60=80x
- B  M6x70=8x
- C  3.5x50=18x
- D  3.5x25=12x
- E  3.0x16=6x
- F  1x

## PARTS

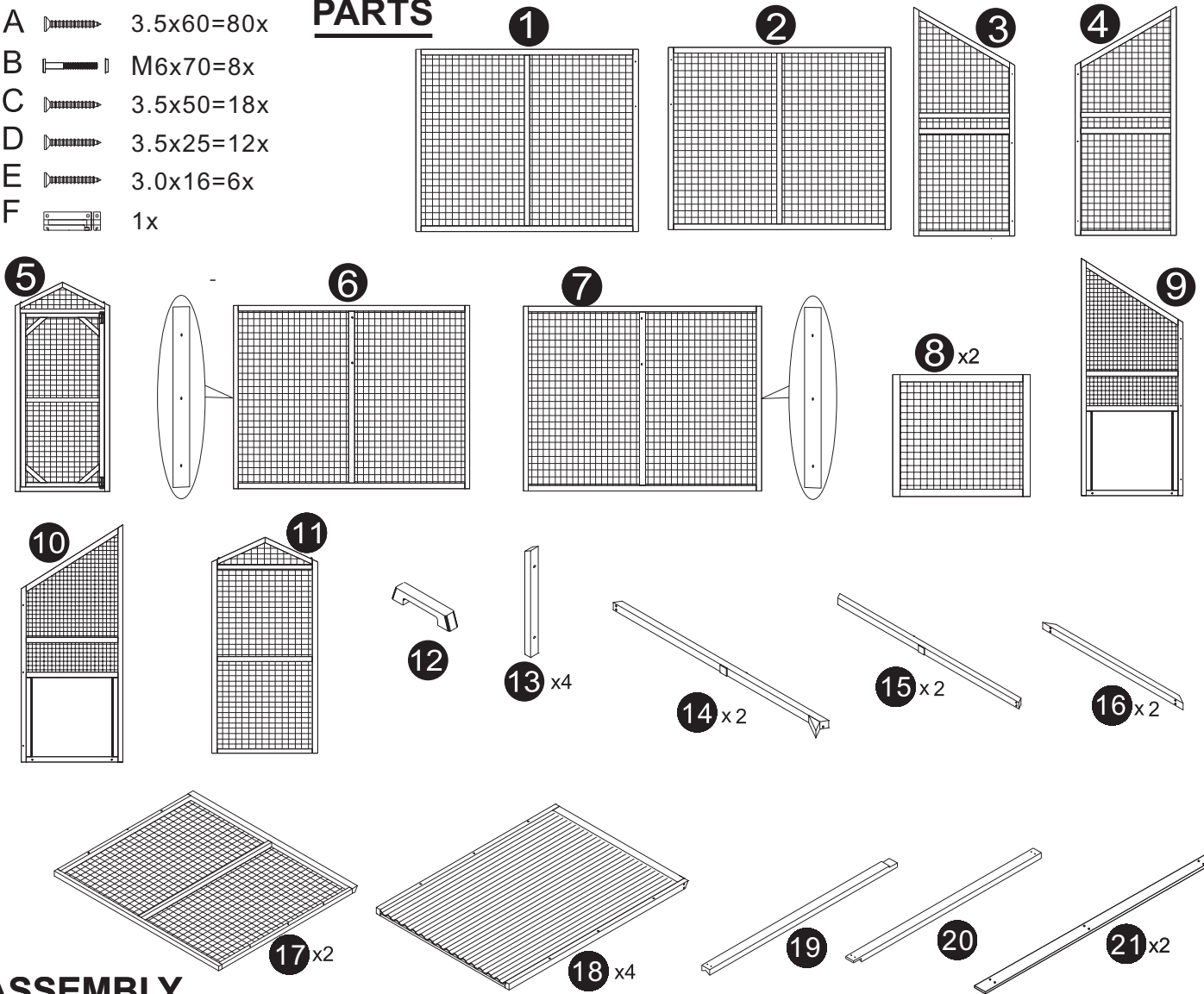

## ASSEMBLY

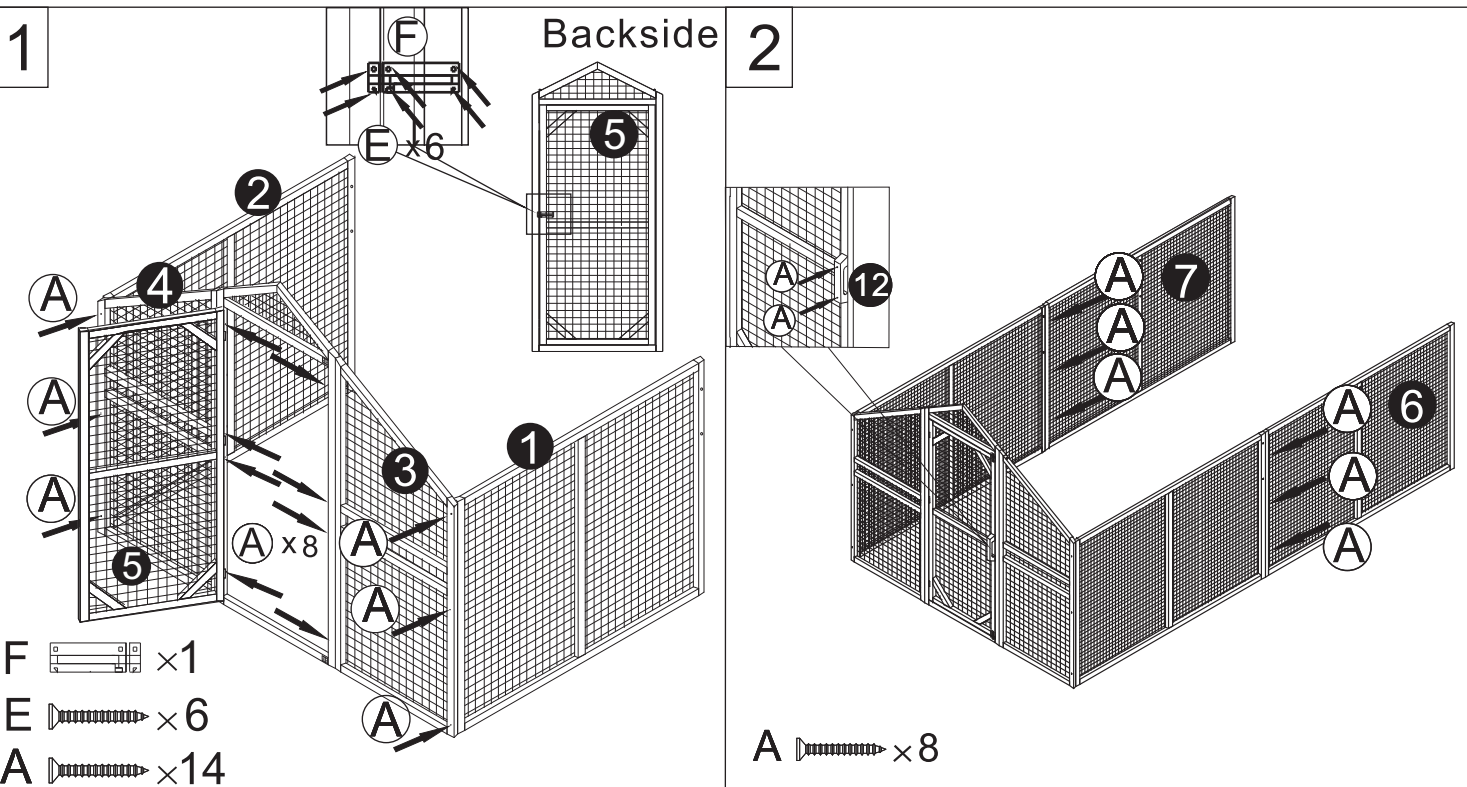

3

9 / 10

Backside

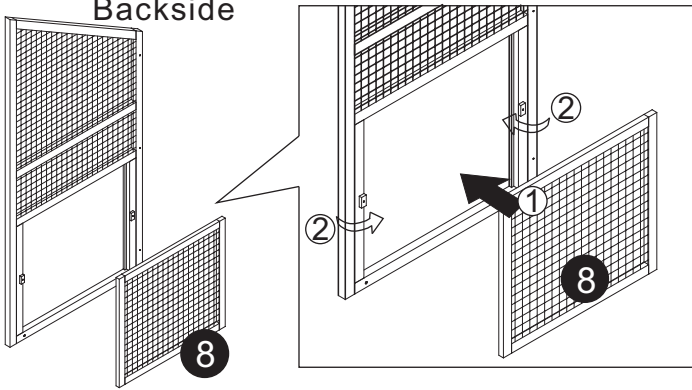

4

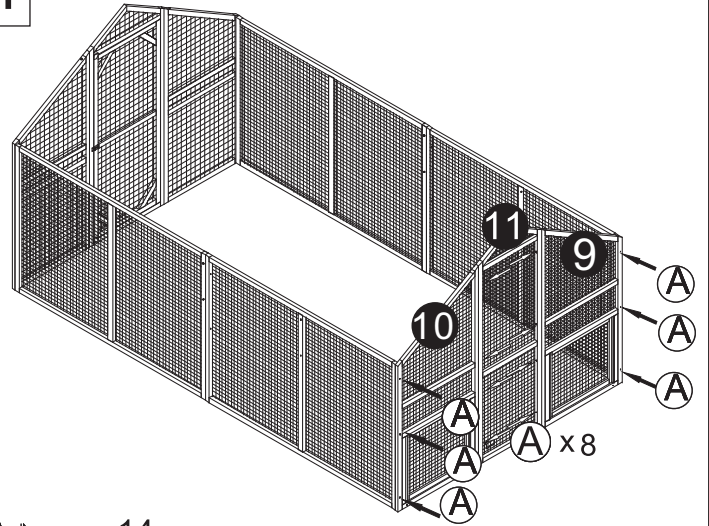

A  x14

5

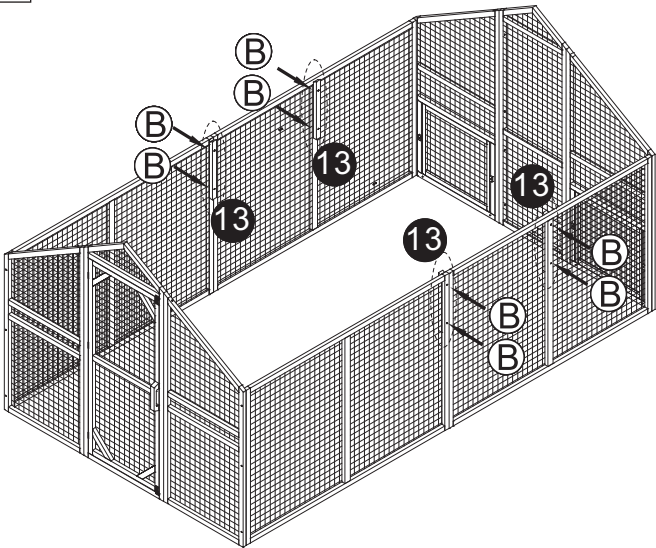

B  x8

6

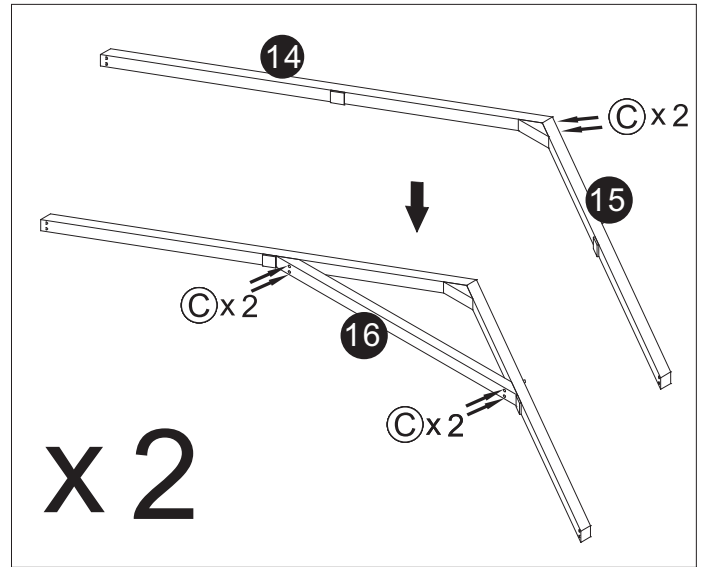

C  x12

7

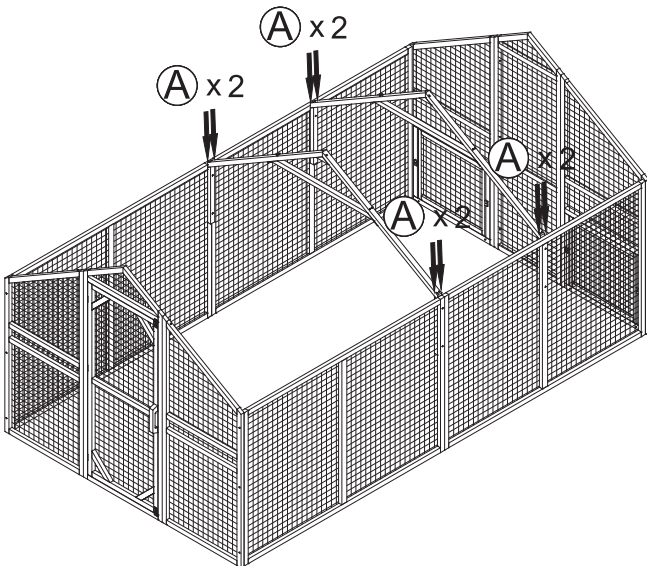

A  x8

8

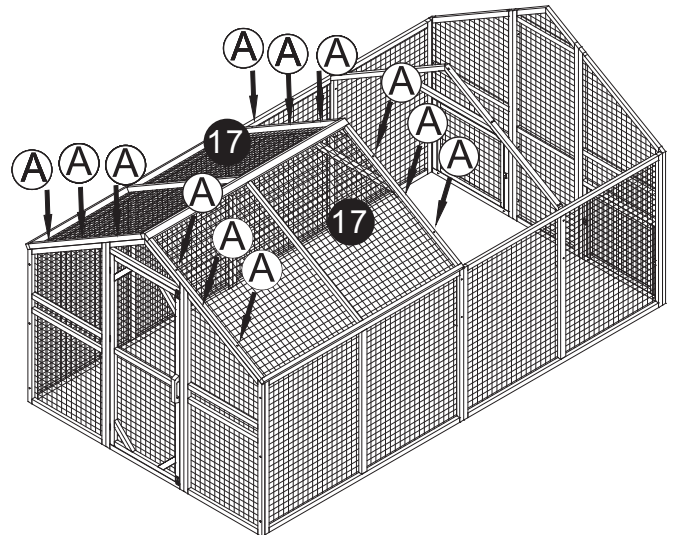

A  x12

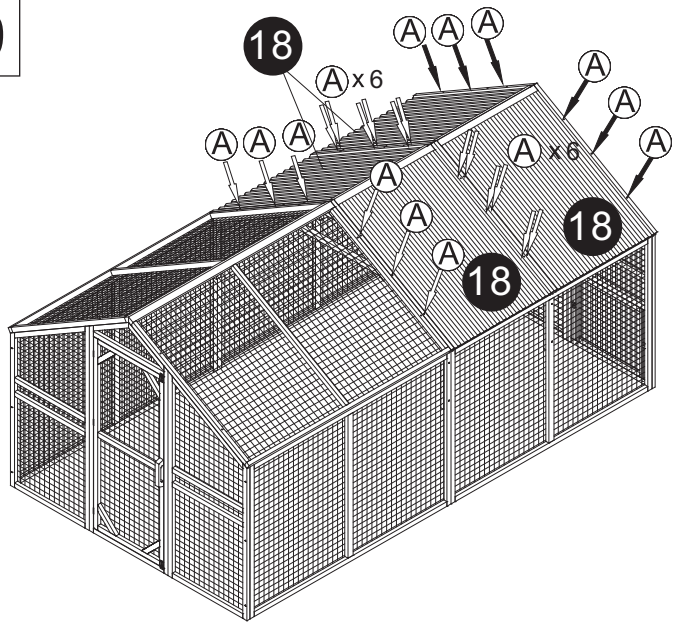

9

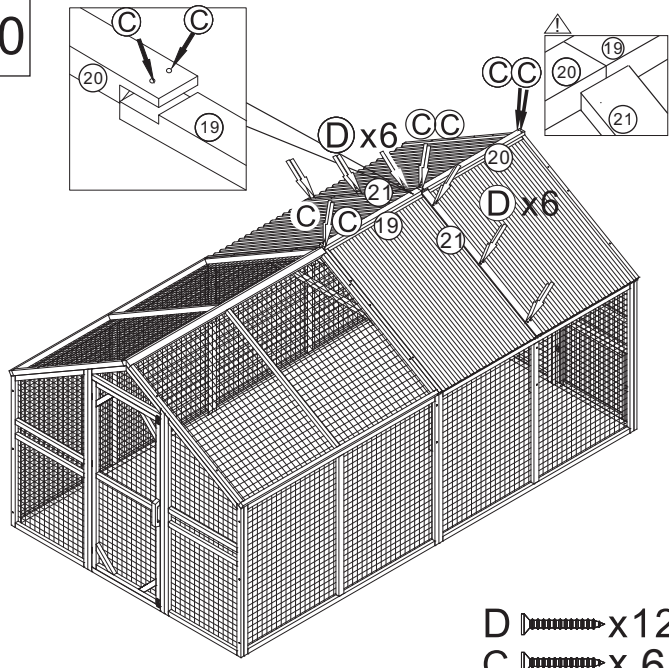

A  x 24

10



D  x12  
 C  x 6