

Haunted Hill Farm®

Thank you for choosing Haunted Hill Farm!

Valuable feedback like yours helps us make our products even better and helps other potential customers on their shopping journey!

If you're fully satisfied, we would love for you to leave us a review where you purchased the product.



If you have any questions, concerns or suggestions, please contact us directly. Our team is here to help!

 **boo@HauntedHillFarm.com** (Anytime)

 **888-840-4559** (9AM to 5PM Eastern Time, M-F)

In the unlikely event that you experience a problem, please provide pictures and a description of the problem, a receipt (if available), name and address of the purchaser and the name of retailer where you purchased the product.

Please do not return this item to the retailer.

See the full Haunted Hill Farm collection and get online support for assembly, troubleshooting, care and maintenance at:

www.HauntedHillFarm.com

SOUL SUCKER™

INSTALLATION AND OPERATING INSTRUCTIONS

KEEP ALL PLASTIC AND WIRE PARTS AWAY FROM CHILDREN

WARNING: DO NOT TURN ON THE PROP UNTIL FULLY ASSEMBLED. STAY CLEAR OF THE PROP WHILE OPERATING.
ESTIMATED ASSEMBLY TIME SEVEN MINUTES.

The model number of your item is printed on the side of your carton.
Always use this number to identify your item.

Thank you for your purchase of this quality Halloween decor. With proper use and care, your Halloween decor will provide you with years of enjoyment. Please follow the instructions on how to assemble and disassemble your item. If you should have any problems with your item, or you have any questions, DO NOT return it to the place of purchase. Please call our toll-free number: **1-888-840-4559** and a customer service representative will assist you. Enjoy your Holiday!



SOUL SUCKER™ is a trademark of Tekky.
Copyright © 2022 Tekky.
All Rights Reserved.
MADE IN CHINA

ASSEMBLY INSTRUCTIONS

Please note: Make sure to add batteries to the battery pack prior to assembly for easier access (batteries not included).

Your package includes:

METAL STAND (1), FABRIC STAND COVER (2), SNAP LOCK POLES (3), WAIST BRACKET AND MODULE (4), LEFT ARM (5), RIGHT ARM (6), HEAD AND CAPE (7), GIRL BODY AND FOG HOSE (8), 6V 2A ADAPTER (9), FOG BRACKET (10), FOG CORD (11), FOG CORD ADAPTER (12), FOG DIFFUSER (13)

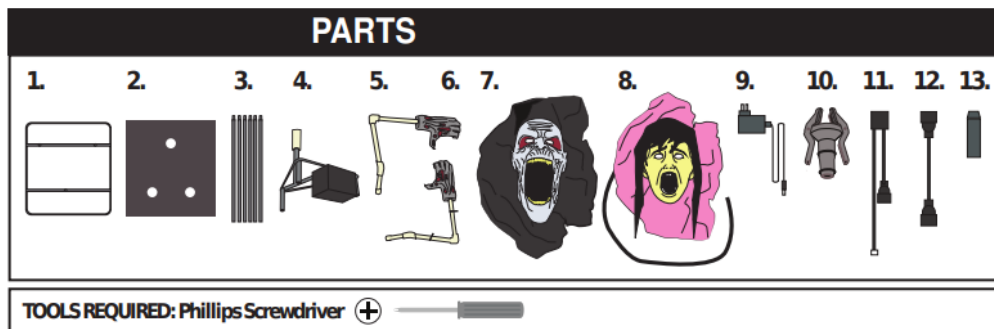

1. Cover the METAL STAND with the FABRIC STAND COVER and insert SNAP LOCK POLES onto the METALSTAND. (Match A to A)_ (Match D to D)

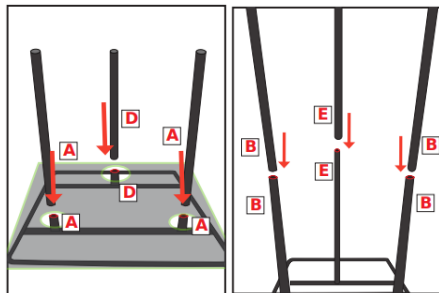

2. Insert SNAP LOCK POLES onto lower SNAP LOCK POLES. (Match B to B) (Match E to E)

3. Insert WAIST BRACKET AND MODULE and SNAP LOCK POLES. (Match C to C) (Match F to F)

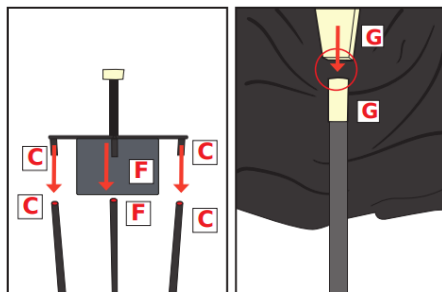

4. Lower the HEAD AND CAPE onto the WAIST BRACKET AND MODULE. (Match G to G)
5. Reach inside the sleeve on the CAPE and insert the RIGHT ARM into the center snap-lock post below the shoulders. (Match H to H)

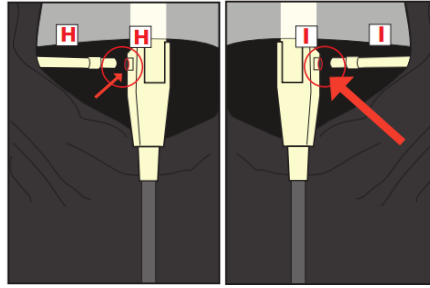

6. Reach into the sleeve on the CAPE on the opposite side and insert the LEFT ARM into the center snap-lock post below the shoulders. (Match I to I)
7. Insert the Snap-lock on the hand of the RIGHT ARM into the shoulder of the GIRL BODY AND FOG HOSE. (Match J to J)

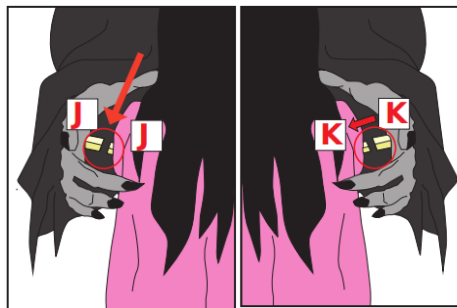

8. Insert the Snap-lock on the hand of the LEFT ARM into the shoulder of the GIRL BODY AND FOG HOSE. (Match K to K)
9. Feed the FOG HOSE with wire harness from the GIRL BODY AND FOG HOSE up the right sleeve and down the inside of the Soul Sucker's CAPE.

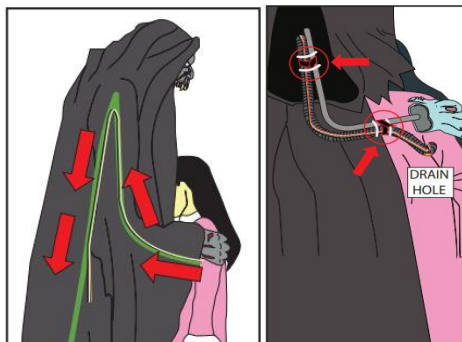

10. Use the two hook and loop fasteners located on the RIGHT ARM to secure the FOG HOSE and wire harness. Fasten lower hook and loop fastener between the two white zip ties. The drain hole will drain excess fog juice. Pull sleeve down over arm.

11. Attach the two hook and loop fasteners on both sides of the HEAD AND CAPE to the Soul Sucker's hand and dress on the GIRL BODY AND HOSE.

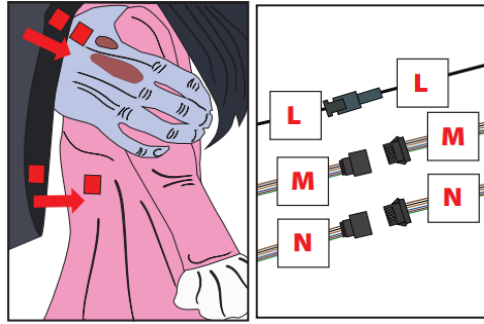

12. Lift the cape and connect the wires labeled, L,M, and N. (Match L to L) (Match M to M) (Match N to N)

13. For optimal fog function during high wind or windy weather, insert the Fog Diffuser with the tapered end upward into the mouth of the GIRL BODY AND FOG HOSE.

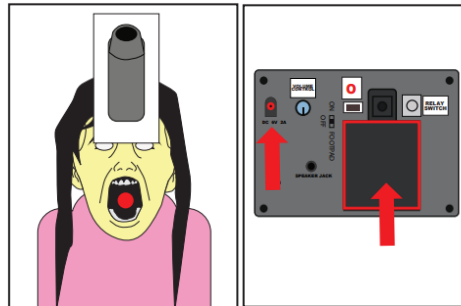

14. Connect 6V 2A ADAPTER (included) or insert 4 AA alkaline batteries (not included) into the battery compartment located on the WAIST BRACKET AND MODULE.

15. Position the item with the sensor located on the left shoulder towards movement, or make a loud sound (clap) for activation AFTER your fog machine set-up. Leave the switch in the OFF position.

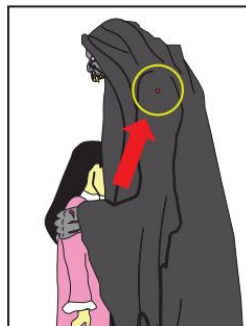

FOG MACHINE SET UP

Your FOG MACHINE (400 or 1000 watt) can be used in conjunction with the SOUL SUCKER.
FOG MACHINE IS NOT INCLUDED. MUST BE PURCHASED SEPARATELY.
ONLY ATTACH A FOG MACHINE AS INSTRUCTED BELOW. ** MAKE SURE SOUL SUCKER IS SET TO THE "OFF" POSITION AND YOUR FOG MACHINE IS TURNED OFF**
Fog Bracket - PATENT <https://tekkydesign.com/pages/terms-conditions.php>

1. Attach fog hose from underneath the cape to the FOG BRACKET. Your fog hose will click and secure in place over the raised surface rings of the FOG BRACKET. (see Illustration A)
Depress the lever arms of the FOG BRACKET and attach to the fog machine nozzle. (see Illustration B)

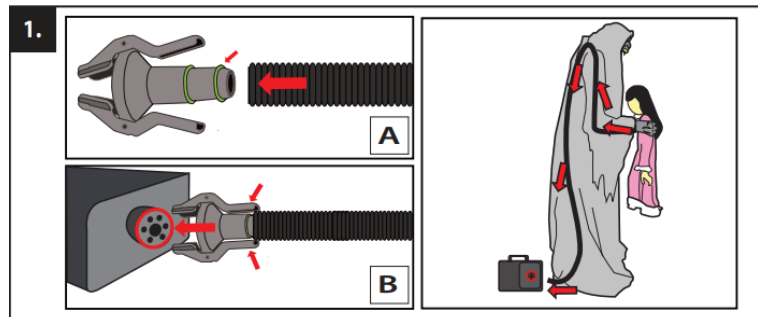

2. Plug the FOG CORD into your fog machine. If the fog cord plug does not fit, see illustration 2A.
2A. Plug the FOG CORD into the FOG CORD ADAPTER. Plug the FOG CORD ADAPTER into your fog machine.

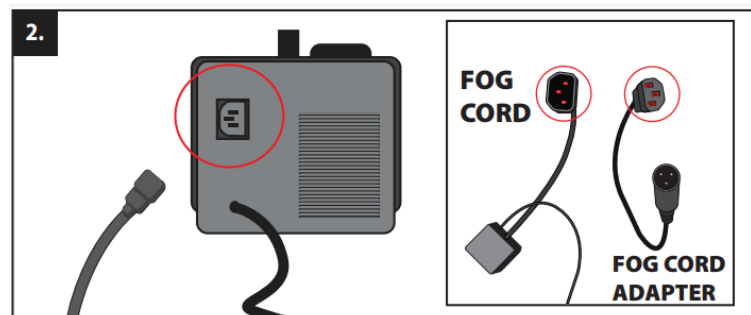

3. Plug the other end of the FOG CORD into jack labeled O on the CONTROL BOX. (Match O to O). Make sure your fog machine is heated up properly, turn your fog machine ON, and then turn the Soul Sucker's switch to the "ON" position.

Make a loud sound (clap) or move in front of the left shoulder. If no fog appears, press the relay switch on the Waist Bracket and Module.

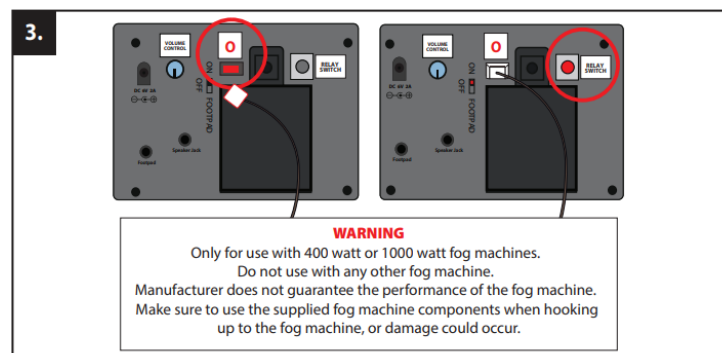

TROUBLESHOOTING

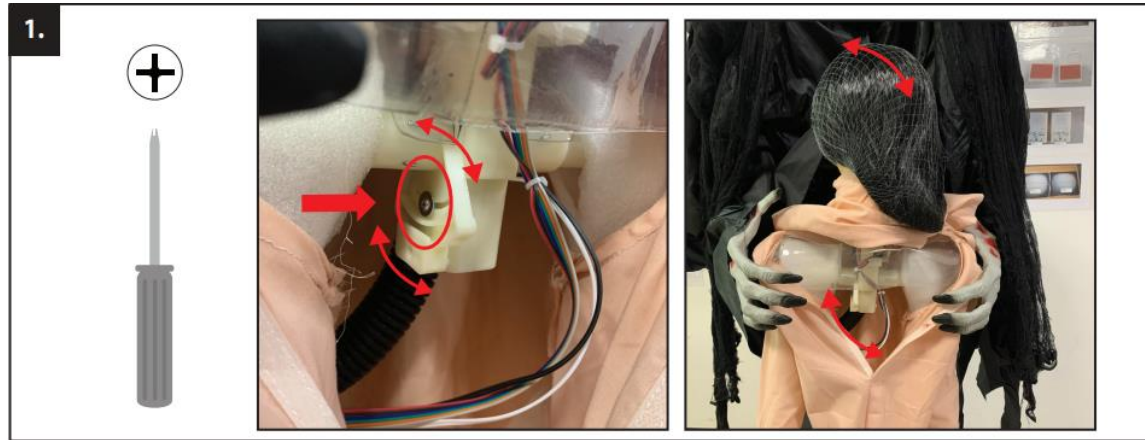

To adjust the head angle and fog direction, loosen the set screw on the neck bracket located beneath the shoulder assembly on the girl figure.

1. Start with the girl's body and Soul Sucker's arms in the UP position. The girl's head will be closer to the Soul Sucker's face.
2. Turn the screw counter clock-wise to loosen the set screw.
3. Gently rotate the head and shoulder assembly to optimize the head angle and fog direction. The head and shoulders will click through several positions as you find the best fogging effect.
4. Turn the set screw clockwise and tighten well to secure the angle of the head and shoulder assembly.

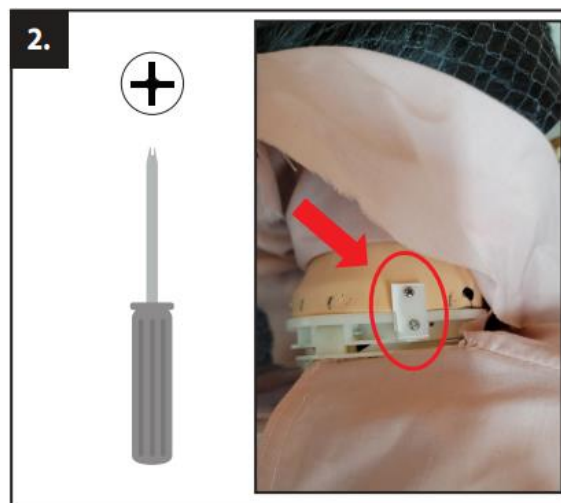

Using Phillips screwdriver, remove both screws and tab located on the girl's neck. Rotate the girl's head left or right as needed to align fog with the Soul Sucker's mouth.

ALL NEW MATERIALS:
METAL, FOAM, PLASTIC, POLYESTER
Surface washable only.

TROUBLESHOOTING AND FAQ

Q: My animatronic is not turning on:

A: Check the battery pack connection. Ensure all batteries are attached and battery pack cover is secure. Check to make sure the power switch is turned on.

Q: My figure is not lighting up

A: If your figure has a light component, check the wires on the inside of the body to make sure all plugs are properly secured. Once secured, please check the battery back and on/off switch to make sure both are on/attached.

Q: Where is the Battery pack on my figure?

A: Please check the back of the figure underneath the clothing. The Battery pack may be covered with a small fabric covering.

IMPORTANT SAFETY INSTRUCTIONS



Warnings

- 1) This product is for indoor or covered outdoor use only. Do not place in direct sunlight.
- 2) This product is for decoration only and is not a toy. Small parts and choking hazard. Use caution with children under the age of 14.
- 3) Do not position the decoration near candles, sources of heat, or in direct sunlight.
- 4) The decoration cannot be connected to the power supply directly.
- 5) Decoration should be on a level, stable surface to prevent it from falling over
- 6) This product is fragile and should be assembled with care.
- 7) Surface washable only.
- 8) Please follow the steps and requirements specified in the instruction to ensure safety and reliability during the installation.

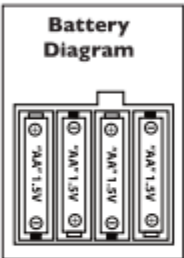
<p>Battery Diagram</p> 	<p>BATTERY INSTRUCTIONS AND CAUTIONS</p> <p>Battery installation and removal should be performed by an adult. Remove batteries when not in use. Use only batteries recommended in the instructions. Do not mix new and used batteries. Do not mix alkaline, carbon-zinc, nickel-cadmium, rechargeable or different types of batteries. Be mindful to insert batteries with the correct polarity (+/-) as indicated. Remove all exhausted batteries. Rechargeable batteries are only to be charged under adult supervision. Rechargeable batteries are to be removed from the item before being charged. Non-rechargeable batteries are not to be recharged. The supply terminals are not to be short-circuited. Always dispose of exhausted batteries properly. Do NOT dispose of batteries in fire, they may leak or explode.</p>
---	---

Warning! This item is not a toy. For decoration only. Small parts, choking hazard. This product is intended for use by persons 15 years of age and older. Not intended for use by children ages 14 years and younger.

WARNING
DO NOT TURN ITEM ON UNTIL YOU HAVE COMPLETELY FINISHED ASSEMBLY.
STAY CLEAR OF ITEM WHILE OPERATING.
DO NOT PLACE ITEM ON UNEVEN GROUND.
DO NOT PLACE WEIGHT ON ITEM WHILE IN OPERATION.

Storage tips: We suggest saving the carton for storing your figurine. Store in a cool, dry area where the temperature does not exceed 100°F.

1-Year Limited Warranty

“Limited” Warranty Program

For a period of one (1) year after purchase, Haunted Hill Farm (“Manufacturer”) will either repair or replace defective components in accordance with this Limited Warranty.

Sales and use taxes, plus shipping and handling charges are the responsibility of the consumer.

This warranty is between Manufacturer and the original purchaser and is valid only when accompanied by the original purchaser’s sales receipt showing original date of purchase and location of purchase. Replacements under this warranty revert back to the date of original purchase for future warranty.

Manufacturer or its authorized dealer can accept or reject warranty claims based on its findings. This warranty applies in normal residential use only, where an issue with the product is due to a defect in material or workmanship. Manufacturer can make substitutions as required of materials, components, and sub-components of comparable value and utility. This warranty is limited to product repair or replacement (to be determined solely by Manufacturer). Warranty return is limited to only the single affected component.

This warranty covers only manufacturing defects and does not cover normal wear and tear, abuse or misuse, including: water damage, chemical damage, exposure to extreme heat or cold, abrasion or excessive weight. This product is intended to be used with standard ornaments only. This warranty is invalid if the product is not used for intended purpose. Manufacturer disclaims liability for any aspect of installation and any inconvenience caused by a defective part or component.

Certain items are not covered by this warranty. These include, but are not limited to the following:

1. Components subjected to abuse, including abuse intended to simulate failure.
2. Damages caused by retailer, shipper or installation crew (such as scratches, dents, tears, etc.).
3. Any part which merely exhibits normal wear yet functions essentially as new, including stretching of materials and stitching.
4. Tears, punctures, scratches or any damage caused by improper installation or use.
5. Items sold “as is” or floor models.

To make a claim, send a copy of the original sales receipt along with a brief description of the problem to the email address below. Please include your email address and daytime telephone or cell phone #. All items may be charged actual freight and handling costs. Repairs or replacement will be made at the Manufacturer’s option.

THIS IS THE ENTIRE EXCLUSIVE EXPRESS LIMITED LIABILITY. THE MANUFACTURER NEITHER MAKES NOR IS RESPONSIBLE FOR ANY OTHER WARRANTIES, EITHER EXPRESS OR IMPLIED, INCLUDING THOSE OF RETAILING DEALERS. THIS EXCLUSIVE REMEDY IS LIMITED TO RECEIPT OF A CREDIT IN CONNECTION WITH THE REPAIR OR REPLACEMENT OF ANY PRODUCT OR COMPONENT DEEMED TO BE DEFECTIVE UNDER THE TERMS AND CONDITIONS AS STATED IN THIS WARRANTY. NEITHER HAUNTED HILL FARM, THE PRODUCT MANUFACTURER NOR ITS AGENTS SHALL BE LIABLE IN ANY CASE FOR INCIDENTAL, INDIRECT, SPECIAL OR CONSEQUENTIAL DAMAGES RESULTING FROM THE USE OF THIS PRODUCT OR ARISING OUT OF ANY BREACH OF THIS WARRANTY OR NEGLIGENCE EVEN IF IT HAS BEEN ADVISED OF THE POSSIBILITY OF SUCH DAMAGES. EXCEPT AS OTHERWISE MAY BE REQUIRED BY LAW, THERE ARE NO OTHER EXPRESS OR IMPLIED WARRANTIES OTHER THAN THE WARRANTY DESCRIBED HEREIN, AND ALL OTHER WARRANTIES, INCLUDING ANY IMPLIED WARRANTY OF MERCHANTABILITY OR FITNESS FOR A PARTICULAR PURPOSE ARE EXPRESSLY DISCLAIMED.

**Boo@HauntedHillFarm.com
1-888-840-4559**