

Thank you for choosing Sunnydaze Decor. We stand behind our brand and the quality of the items we sell. Replacement parts or products will be sent at our discretion within the 1-year warranty period. Proof of purchase, with the date of purchase as well as photos of the merchandise defect, must be provided. Photos are used to determine the cause of defects and for future quality control. Register your warranty at <https://tiny.cc/SunnydazeWarranty>. If you have any questions, comments or concerns, feel free to contact us by phone at 833-982-1977, by email: customerservice@sunnydazedecor.com, or via our contact us page at <https://tiny.cc/SunnydazeContact>

PORCH SWING WITH CHAINS

LAM-460

Read all assembly and care instructions carefully before using this product. Save this manual for future reference.
Assemble components on a soft, clean surface to avoid damaging the finish.



Inspect packaging to ensure all parts are accounted for before disposing of packing materials.

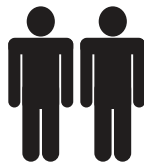
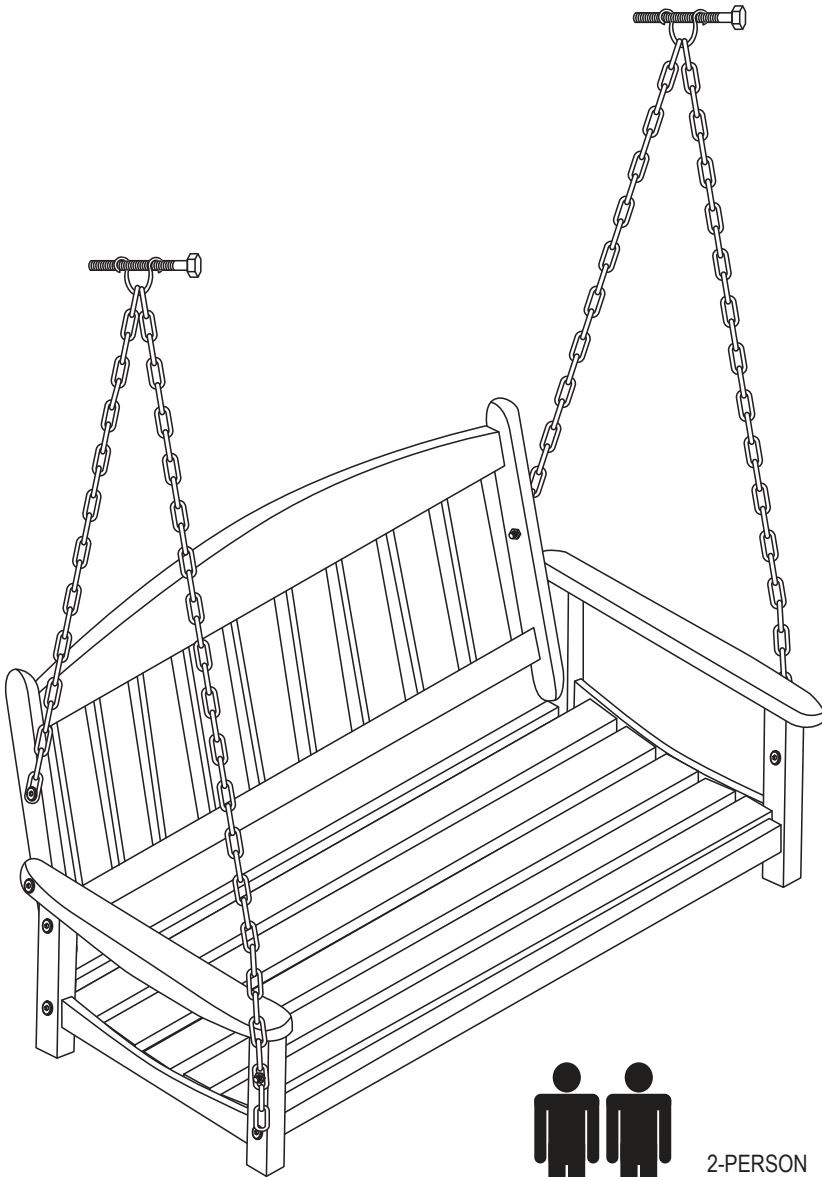









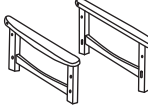
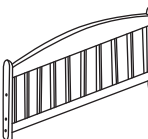
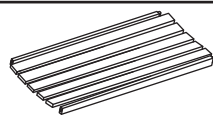









2-PERSON
ASSEMBLY
RECOMMENDED

⚠ WARNING ⚠

CHOKING HAZARD — This item contains small parts that can be swallowed. Keep children and pets away during assembly.

NOTE: Over time, and with use, the bolts may become loose. Save the included tools for tightening loosened hardware.

No.	PARTS		QTY.
A		Armrest (L/R)	2
B		Backrest	1
C		Seat	1
D		JCBC M6x40mm Bolt	4
E		JCBC M6x40mm Bolt	4
F		Barrel Nut	4
G		Barrel Nut Driver	1
H		Hex Key	1

No.	CHAIN ASSEMBLY HARDWARE		QTY.
1		M12x6mm Hex Bolt	2
2		M12 Hex Nut	2
3		U-Hook	2
4		Short Chain	2
4.1		Long Chain	2
5		M8 Nut	4
6		Nylon Washer	4
7		JCB B M8x50mm Bolt	4
8		M8 Washer	8
9		M5 Key	1
10		M13 Spanner	1
11		M19 Spanner	1

BENCH ASSEMBLY

Review all steps and understand assembly before beginning.

Do not fully tighten hardware until all components have been loosely assembled.

If bolts are tightened too soon, mounting holes may not align, and parts may not easily fit together.

TIP: Always fully insert the hex key inside the designated notch of the bolt.

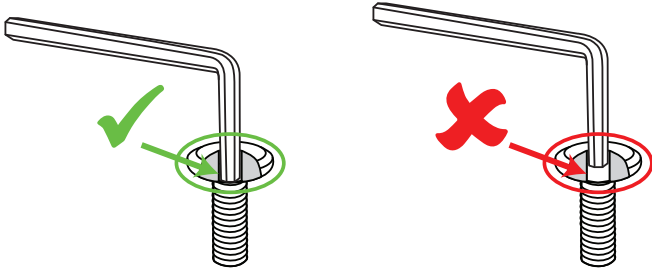

If the hex key is not fully inside the notch, the hex key could slip out, causing damage to the bolt head. Repeated hex key slipping will cause the notch to become rounded, making it difficult or impossible to tighten the bolt with the hex key.

STEP 1

A: 1
C: 1
E: 2
F: 2

TIP: Use the barrel nut driver to hold the barrel nut while the bolt is loosely secured.

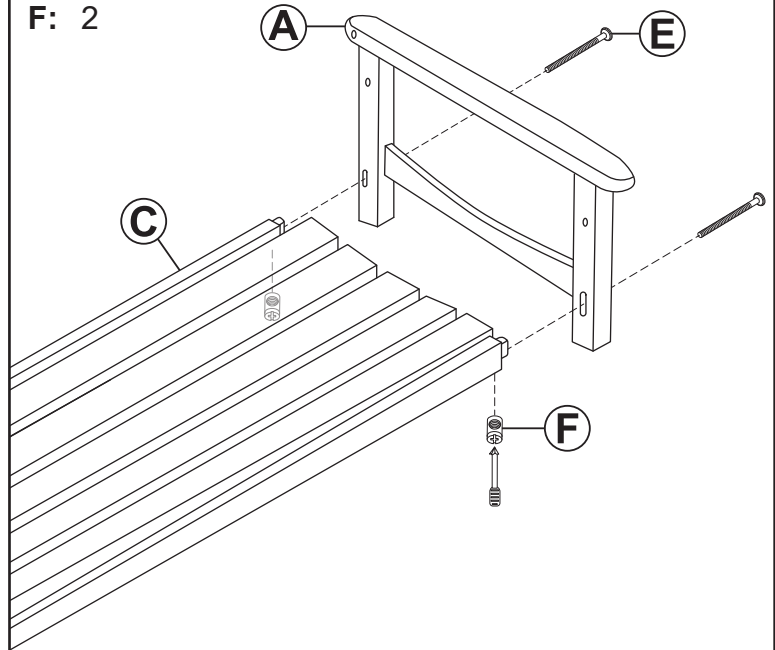

Do not fully tighten hardware.

STEP 2



Assistance is recommended for this step.

B: 1
D: 2

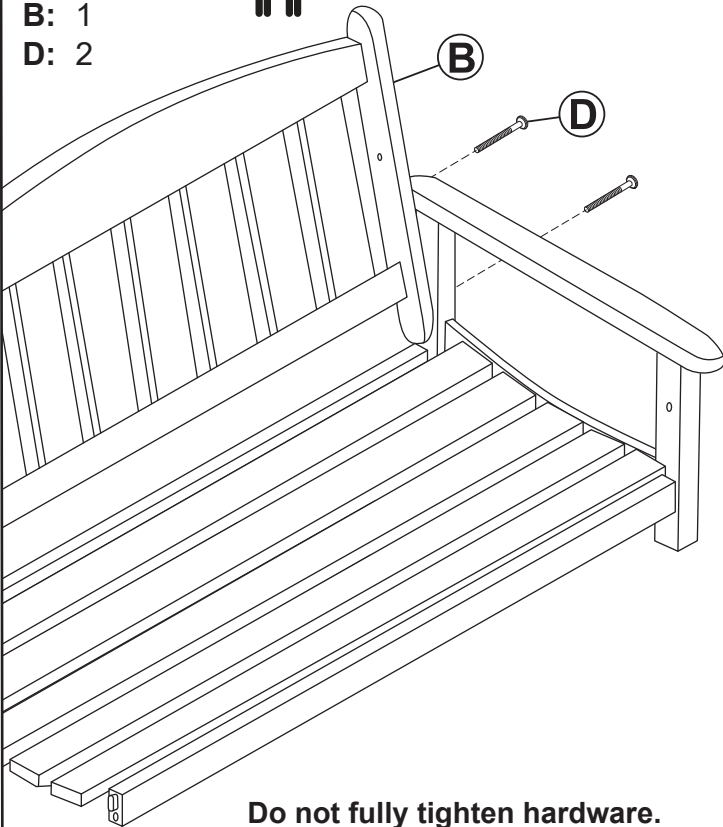

Do not fully tighten hardware.

STEP 3

D: 2
E: 2
F: 2

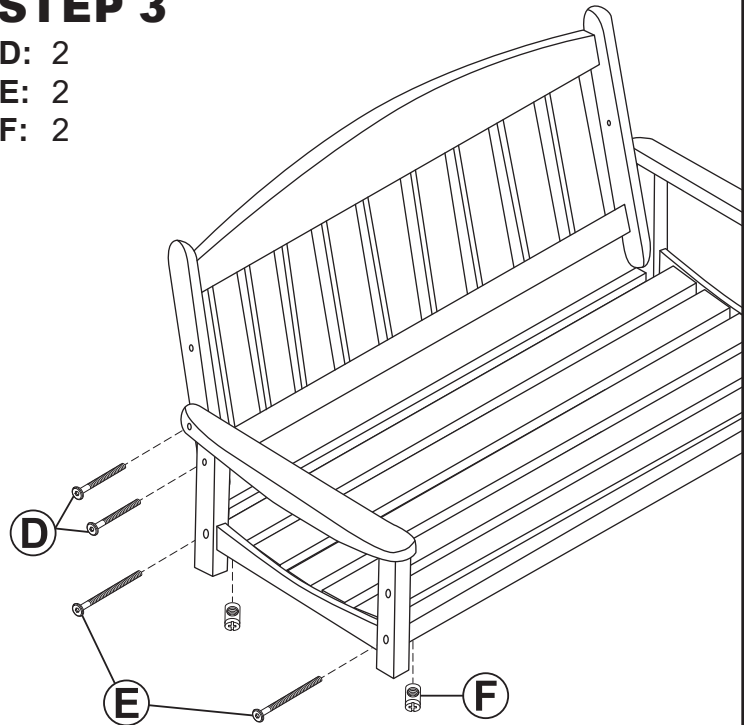

Tighten all hardware after this step is complete.

CHAIN ASSEMBLY

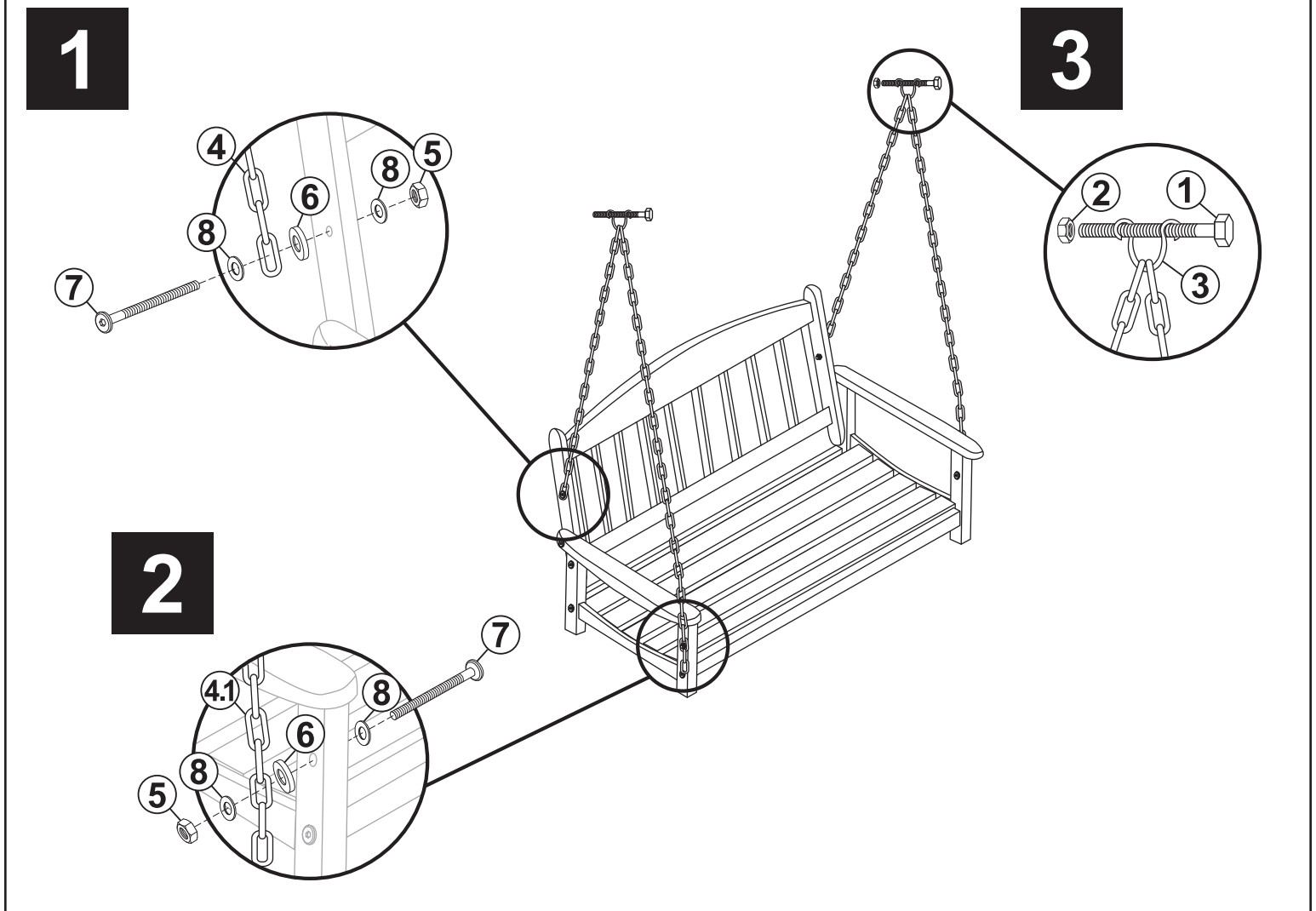

***The installation area must be checked for suitability and strength.
Professional installation is recommended.***

! IMPORTANT INFORMATION & HELPFUL HINTS !

- We recommend installing the swing on a properly-sized, sturdy swing frame (not included); the swing frame must have the capacity to support the full weight of the swing and occupants while the swing is in use.
- Professional installation is highly recommended when installing under a structure.
- The included hanging hardware may not be suitable for installation under all structure types. Consult a certified contractor to ensure the installation location is safe, and can support the weight of the swing while occupants are using it.
- The chains allow for an adjustable swing height. The seat of the swing should be at a height where the user(s) can enter and exit the swing safely. Adjust the height of the swing by evenly shortening the chain length on the U-hook.

! WARNING:

Manufacturer and seller expressly disclaim any and all liability from personal injury, property damage or loss, whether direct or indirect, or incidental, resulting from the incorrect attachment, improper use, inadequate maintenance, or neglect of this product.



Care & Maintenance

SAFE USE: Professional installation recommended. Do not stand or climb on any part of this unit.

INSPECT: Periodically check hardware and tighten as necessary.

CLEANING: Following the woodgrain, wipe with a soft cloth to remove dust, dirt, and debris. Do not use chemicals or abrasive materials as they will damage the wood.

WINTER CARE & STORAGE: Maintain the appearance and prevent damage by storing this item indoors when not in use.

Wood expands when wet and contracts when it dries. Therefore, repeated and excessive exposure to moisture, rain, and snow can damage the product. The resulting damage includes, but is not limited to, assembly points becoming loose, wood cracking, mold and mildew growth, and hardware rust.

MAINTENANCE: If left untreated, the wood will weather. To maintain the appearance, apply a suitable penetrating wood oil (not included) at least once per year or when the wood looks particularly dry.

Before applying a suitable wood oil, clean the unit and bring it into a dry, warm, indoor location. Allow the unit to dry thoroughly before applying oil; drying may take several days. Only apply oil to wooden surfaces. Apply oil as directed by the wood oil manufacturer.

WARNING: THE ONE-YEAR WARRANTY DOES NOT COVER DAMAGES OR DEFECTS CAUSED BY THE USE OF PROTECTIVE COATINGS OR CHEMICAL TREATMENTS.

SAFETY STATEMENTS & WARNINGS

- Do not exceed the weight capacity of the furniture.
- Do not stand on the swing.
- Inspect hardware often and tighten loose hardware before use.
- Do not put hot items on or near furniture.
- Do not allow children to use this product without adult supervision.
- Do not use harsh chemicals or abrasive materials to clean the furniture.
- Do not use a pressure washer to clean the furniture.

Any modification to the product or failure to follow recommended care will void the product warranty.

WARNING:

Manufacturer and seller expressly disclaim any and all liability from personal injury, property damage or loss, whether direct or indirect, or incidental, resulting from the incorrect attachment, improper use, inadequate maintenance, or neglect of this product.