

Thank you for choosing Sunnydaze Decor. We stand behind our brand and the quality of the items we sell. Replacement parts or products will be sent at our discretion within the 1-year warranty period. Proof of purchase, with the date of purchase as well as photos of the merchandise defect, must be provided. Photos are used to determine the cause of defects and for future quality control. Register your warranty at <https://tiny.cc/SunnydazeWarranty>. If you have any questions, comments or concerns, feel free to contact us by phone at 833-982-1977, by email: customerservice@sunnydazedecor.com, or via our contact us page at <https://tiny.cc/SunnydazeContact>

TRADITIONAL WOODEN PORCH SWING DSL-521

Review all assembly and care information before using this product.
Save this manual for future reference.

Assemble components on a soft, clean surface to avoid damaging the finish.

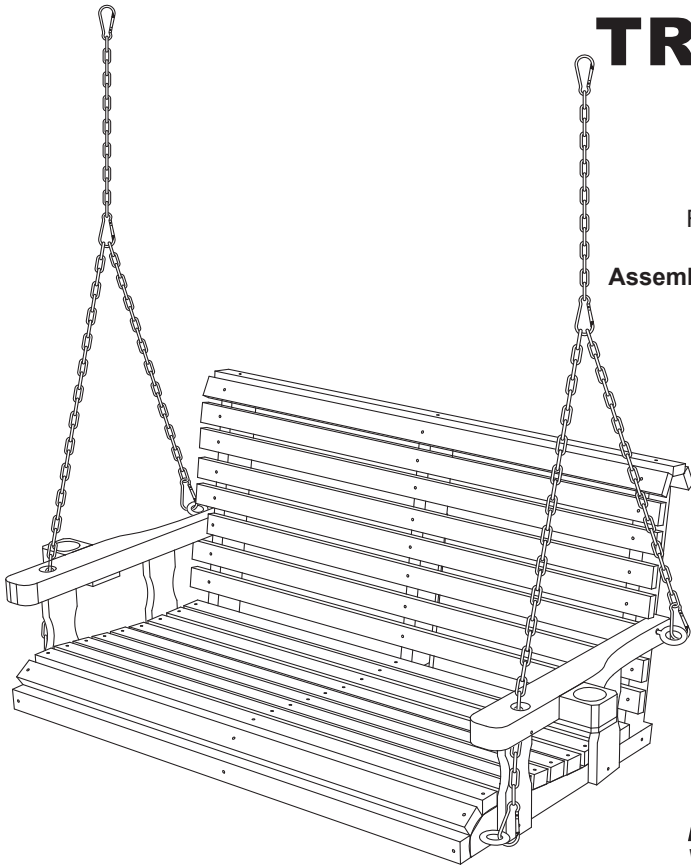







395
pounds
180 kg
Weight Capacity







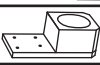
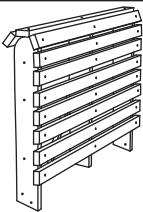
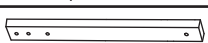
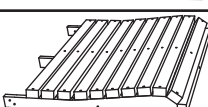



2-PERSON
ASSEMBLY/
INSTALLATION
RECOMMENDED



Inspect packaging to ensure all parts are accounted for before disposing of packing materials.
Save the packing slip.

No.	PARTS		QTY.
A		Left Armrest	1
B		Right Armrest	1
C		Front Armrest Support	2
D		Left Back Armrest Support	1
D1		Right Back Armrest Support	1
E		Cup Holder	2
F		Backrest	1
G		Back Brace	1
H		Seat	1
I		Hanging Chain Set	2

No.	HARDWARE		QTY.
1		M4x40mm Screw	8
2		M10x65mm Bolt Set	8
3		M4x35mm Screw	4
4		M4x30mm Screw	8
5		Seat Eye Bolt Set	2
6		Arm Eye Bolt Set	2

INCLUDED TOOLS	
	Back Nut Tap Spanner with Pivot Pin (x2)
	Phillips Screwdriver Hex Key



Save included tools for tightening hardware in the event it becomes loose.

⚠ WARNING ⚠

CHOKING HAZARD — This item contains small parts that can be swallowed. Keep children and pets away during assembly.

ASSEMBLY

Carefully review all steps and understand assembly before beginning.

! IMPORTANT TIP !

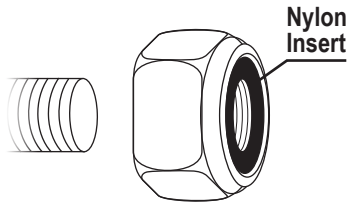

When installing a lock nut, make sure the raised center portion with the nylon insert faces outward; the flat surface goes on the bolt first. Hand-tighten until you feel resistance, which is caused by the nylon insert.

STEP 1

A: 1
B: 1
E: 2
4: 8

IMPORTANT: Install the cup holders between the pre-drilled grooves on the underside of the armrest.

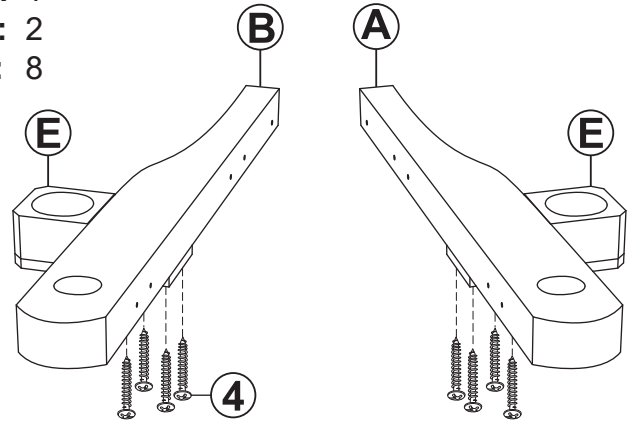

Align one Cup Holder (E) with Right Armrest (B) and secure using four M4x30mm Screws (4).

Repeat to secure the remaining cup holder to Left Armrest (A).

STEP 2

C: 2
D: 1
D1: 1
1: 8

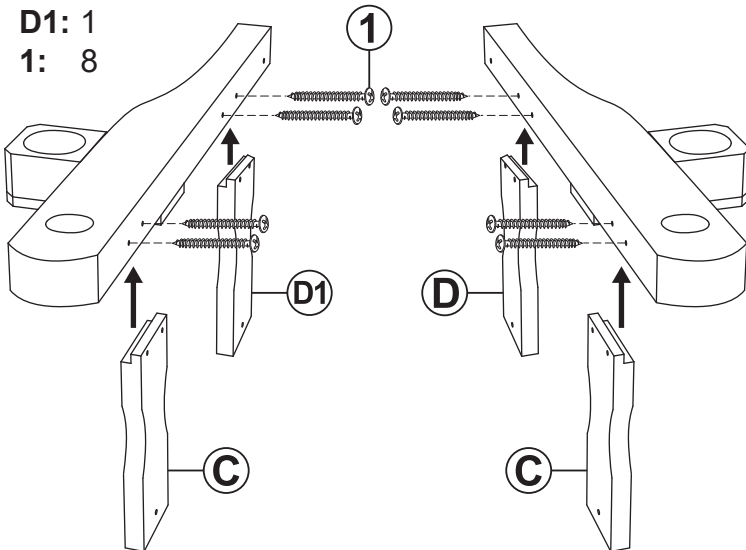

Secure one Front Arm Support (C) and Right Back Armrest Support (D1) to the right armrest using four M4x40mm Screws (1).

Repeat to secure the remaining front arm support and Left Back Armrest Support (D) to the left armrest.

STEP 3

F: 1
H: 1
2: 4

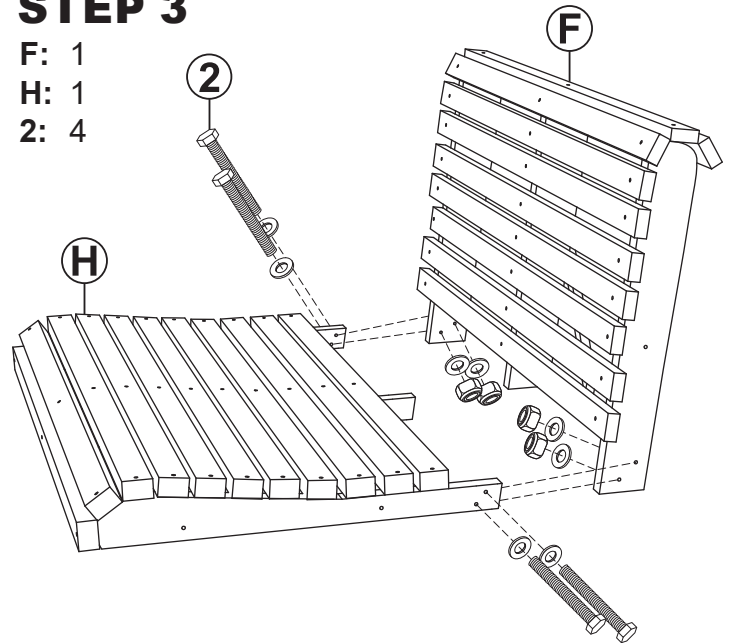

Loosely fasten Backrest (F) to Seat (H) using four M10x65mm Bolt Sets (2).

Do not fully tighten hardware until Step 6 is complete.

STEP 4

G: 1

3: 4

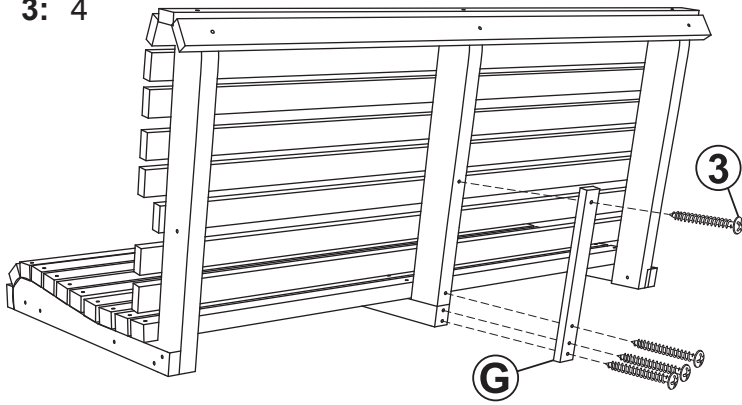

Loosely secure Back Brace (G) to the backrest and loosely se, as shown.

Do not fully tighten hardware until Step 6 is complete.

STEP 5

2: 4

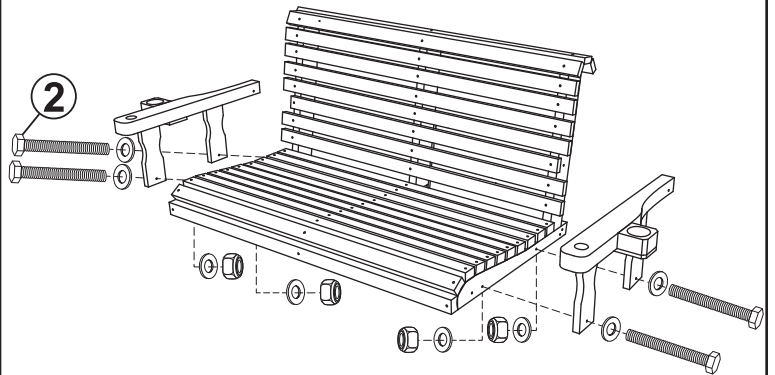

Loosely secure the armrest supports to the seat using four M10x65mm Bolt Sets (2).

Do not fully tighten hardware until Step 6 is complete.

STEP 6

5: 2

6: 2

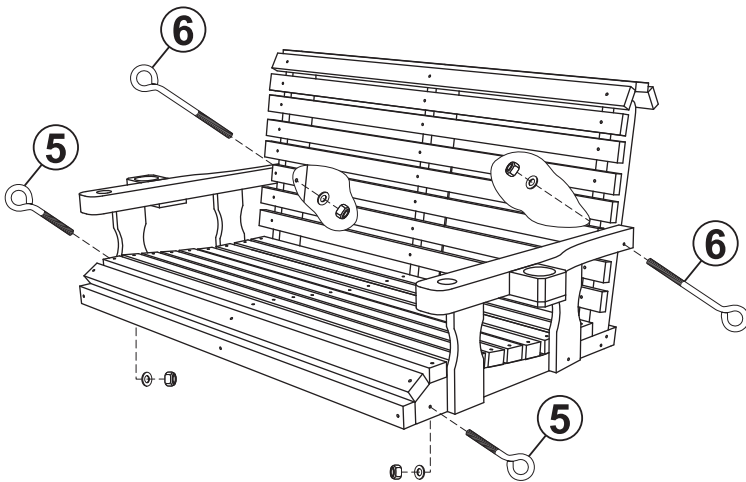

Secure the back of the armrests to the seat using two Arm Eye Bolt Sets (6), as shown.

Then, install two Seat Eye Bolt Sets (5) to the front of the seat, as shown.

After this step is complete,
fully tighten all hardware from previous steps.

STEP 7

I: 2

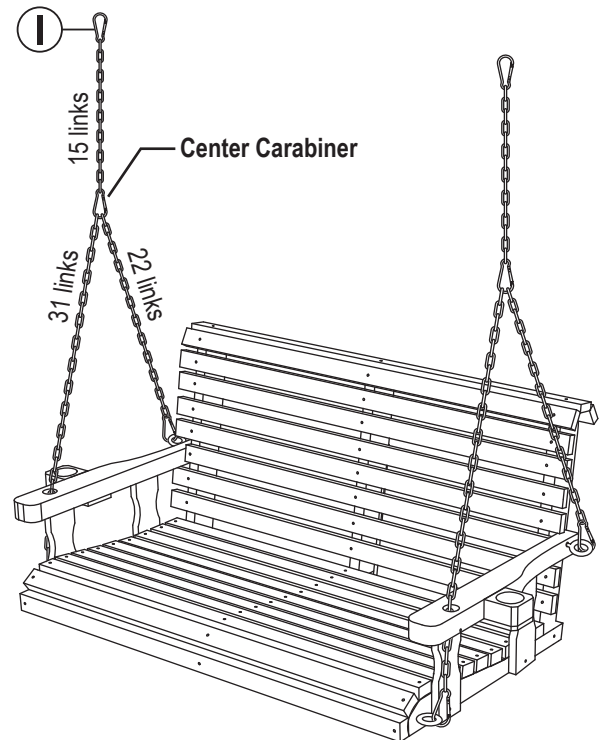

Link the carabiner on the second-longest chain to arm eye bolt. Link the the longest chain to the eye bolt on the front of the seat. Disconnect the longest chain from the center carabiner, run the chain up through the bottom of the hole in the armrest, reconnect it to the center carabiner.

⚠ WARNING:

Manufacturer and seller expressly disclaim any and all liability from personal injury, property damage or loss, whether direct or indirect, or incidental, resulting from the incorrect attachment, improper use, inadequate maintenance, or neglect of this product.

Professional installation is recommended.

The intended installation area must be checked for suitability and strength.

! IMPORTANT INFORMATION & HELPFUL HINTS !

- We recommend installing the swing on a properly-sized, sturdy swing frame (not included); the swing frame must have the capacity to support the full weight of the swing and occupants while the swing is in use.
- ****Professional installation is highly recommended.** The hardware required for installation under a structure is not included. Consult a certified contractor to ensure the structure to which the swing will be installed is safe, and can support the weight of the swing and occupants while in use.
- The included chains and carabiners allow for an adjustable swing height. The seat of the swing should be at a height where the user(s) can enter and exit the swing safely. Adjust the height of the swing by the top carabiner and 15-link chain only.



Care & Maintenance

SAFE USE: Professional installation recommended. Do not stand or climb on any part of this unit.

INSPECT: Periodically check hardware and tighten as necessary.

CLEANING: Follow the woodgrain with a soft cloth to remove dust, dirt, and debris. Do not use chemicals or abrasive materials as they will damage the wood.

WINTER CARE & STORAGE: Maintain the appearance and prevent damage by storing this item indoors when not in use.

Wood expands when wet and contracts when it dries. Therefore, repeated and excessive exposure to moisture, rain, and snow can damage the product. The resulting damage includes, but is not limited to, assembly points becoming loose, wood cracking, mold and mildew growth, and hardware rust.

MAINTENANCE: If left untreated, the wood may weather. To maintain the appearance, apply a suitable penetrating wood oil (not included). Reapply yearly or when the wood looks particularly dry.

Before applying a suitable wood oil, clean the unit and bring it into a dry, warm, indoor location. Allow the unit to dry thoroughly before applying oil; drying may take several days. Only apply oil to wooden surfaces. Apply oil as directed by the wood oil manufacturer.

WARNING: THE ONE-YEAR WARRANTY DOES NOT COVER DAMAGES OR DEFECTS CAUSED BY THE APPLICATION OF CHEMICAL TREATMENTS, PROTECTIVE COATINGS, OR CLEANING PRODUCTS.

! SAFETY STATEMENTS & WARNINGS !

- Do not exceed the weight capacity of the furniture.
- Do not stand on the swing.
- Inspect hardware often and tighten loose hardware before use.
- Do not put hot items on or near furniture.
- Do not allow children to use this product without adult supervision.
- Do not use harsh chemicals or abrasive materials to clean the furniture.
- Do not use a pressure washer to clean the furniture.

Any modification to the product or failure to follow recommended care will void the product warranty.

! WARNING:

****Manufacturer and seller expressly disclaim any and all liability from personal injury, property damage or loss, whether direct or indirect, or incidental, resulting from the incorrect attachment, improper use, inadequate maintenance, or neglect of this product.**

