

KINGSMITH WalkingPad Treadmill User Manual

Please read this manual carefully before using and then keep it in a safe place.



800642 IC: 25276-R1B
FCC ID: 2ARDB-TRR11B

Manufacturer: Beijing Kingsmith Technology Co., Ltd.
Address: Floor 4, Building 25, Area 18, ABP Park, Fengtai, Beijing, China.
MADE IN CHINA

Model No. : *TRR2F*

WalkingPad

KING SMITH



IMPORTANT SAFETY INSTRUCTIONS

The appliance is intended for residential use.



DANGER – To reduce the risk of electric shock:

Always unplug this appliance from the electrical outlet immediately after using and before cleaning.



WARNING – To reduce the risk of burns, fire, electric shock, or injury to persons:

- 1) An appliance should never be left unattended when plugged in. Unplug from outlet when not in use, and before putting on or taking off parts.
- 2) Close supervision is necessary when this appliance is used by, or near children, invalids, or disabled persons.
- 3) Use this appliance only for its intended use as described in this manual. Do not use attachments not recommended by the manufacturer.
- 4) Never operate this appliance if it has a damaged cord or plug, if it is not working properly, if it has been dropped or damaged, or dropped into water. Return the appliance to a service center for examination and repair.
- 5) Do not carry this appliance by the supply cord or use the cord as a handle.
- 6) Keep the cord away from heated surfaces.
- 7) Never drop or insert any object into any opening.
- 8) Do not use outdoors.
- 9) Do not operate where aerosol (spray) products are being used or where oxygen is being administered.
- 10) To disconnect, turn all controls to the off position, then remove the plug from the outlet.

IMPORTANT SAFETY INSTRUCTIONS



1. This appliance can be used by children aged from 8 years and above and persons with reduced physical, sensory or mental capabilities or lack of experience and knowledge if they have been given supervision or instruction concerning use of the appliance in a safe way and understand the hazards involved. Children shall not play with the appliance. Cleaning and user maintenance shall not be made by children without supervision.
2. Correct Disposal of this product. This marking indicates that this product should not be disposed with other household wastes throughout the EU. To prevent possible harm to the environment or human health from uncontrolled waste disposal, recycle it responsibly to promote the sustainable reuse of material resources. To return your used device, please use the return and collection systems or contact the retailer where the product was purchased. They can take this product for environmental safe recycling.

This appliance is not intended for use by persons (including children) with reduced physical, sensory or mental capabilities, or lack of experience and knowledge, unless they have been given supervision or instruction concerning use of the appliance by a person responsible for their safety.

Children should be supervised to ensure that they do not play with the appliance.

WARNING: keep young children away from this machine at all times. Contact with the moving surface may result in severe friction burns.

Contents

01. Product and Accessories	02
02. Function Diagram	03
03. Set-Up Guide	07
04. Learn to Use the Treadmill	09
05. Trademark and Legal Notice	12
06. Safety Instruction	13
07. Maintenance and Adjustments	16
08. Replacement and Disposal	17

Welcome

Thank you for choosing KINGSMITH WalkingPad Treadmill, and hereinafter referred to as "Treadmill". The exquisite, simple, and innovative design afford quality and enjoyable workouts at home. This Treadmill is designed for residential use only. Please do not use it for any commercial, leasing, or public group purpose.

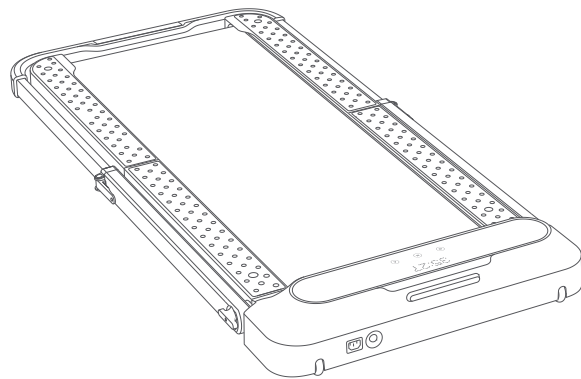

Reference Index	Parameter
Applicable Age	14-60 years old
Speed Range	Walking Mode: 0.5-6km/h(0.5-3.7mi/h) Running Mode: 0.5-10km/h(0.5-6.2mi/h)
Running Area	440×1200 mm (17"×47")
Max Load	110 kg (240 lbs)
Frequency	50/60 Hz
Voltage	100-127 V~
Power Input	918 W
Net Weight	36 kg (81 lbs)
Unfold Size	1452×720×1032 mm (57"×28"×40.5")
Folded Size	1000×720×162 mm (39"×28"×6")
Working Mode	Running Mode/Walking Mode

01. Product and Accessories

Please check if the items inside the packaging are complete and intact. In case of any item missing or broken, please contact the seller.

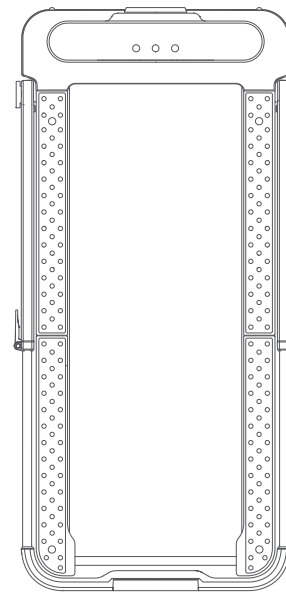

Treadmill

Accessories



Power cord



Remote control



Remote control lanyard



Hex L Shaped Wrench



Safe Lock



Silicone Oil

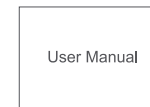

User Manual

02. Function Diagram

1. Walking Mode

The handrail is horizontal when the treadmill is in walking mode. The maximum speed in this mode is 6 km/h. In this mode, manual (M) and automatic (A) modes can be used. It has a speed limit of 3 km/h when the treadmill is used for the first time. Unlocking the speed limit of 6 km/h can be done in three ways: Finishing beginner guidance on the KS Fit APP, walking on the treadmill for 1 km, setting the speed limit on the "KS Fit" APP.

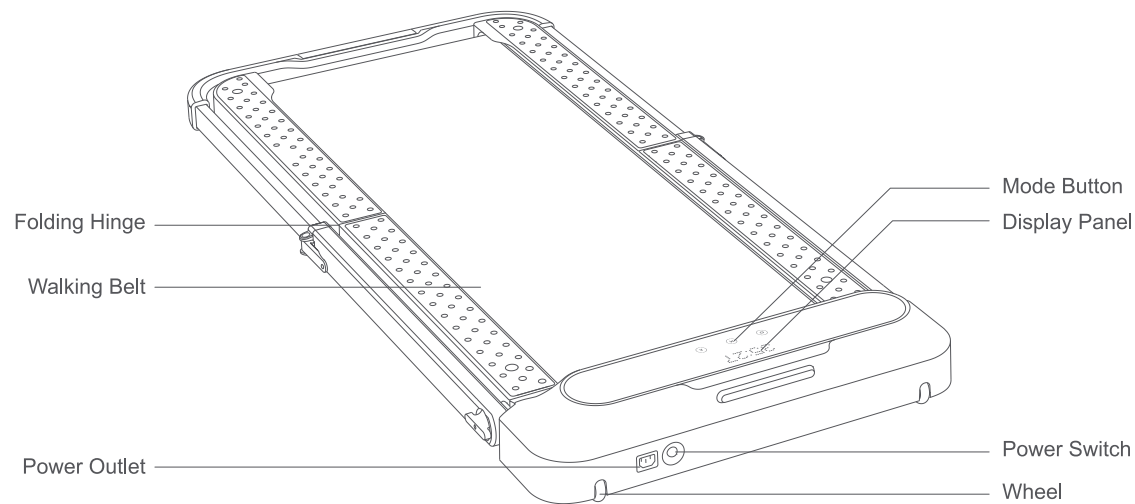

2. Running Mode

The handrail is vertical when the treadmill is in running mode. The maximum speed in this mode is 10 km/h. In this mode, the manual (M) mode can be used. For safety reasons, running mode does not support automatic mode (A).

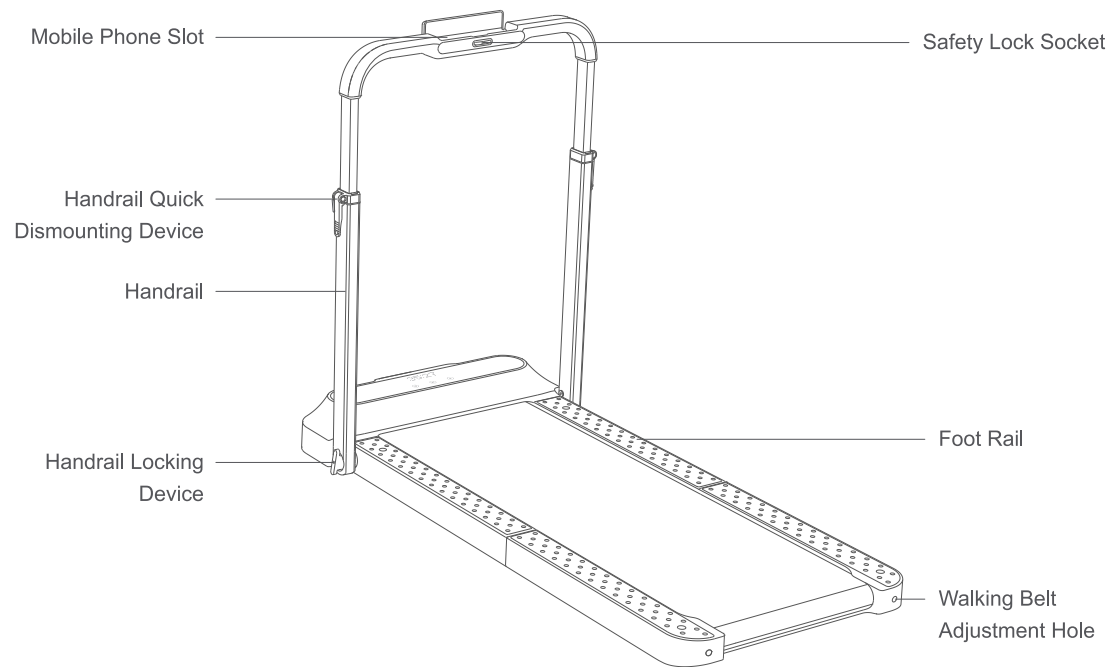

02. Function Diagram

3. Display Panel Function

TIME KM SPD STEP CAL

Time

Distance

Speed

Steps

Calories

* Step and Calorie data can be displayed on the panel after being set in the APP.

Touch Key-press



Standby Mode



Manual Mode



Automatic Mode

Indicator Light



Fault Caution Light



Connection Caution Light

4. Remote Control

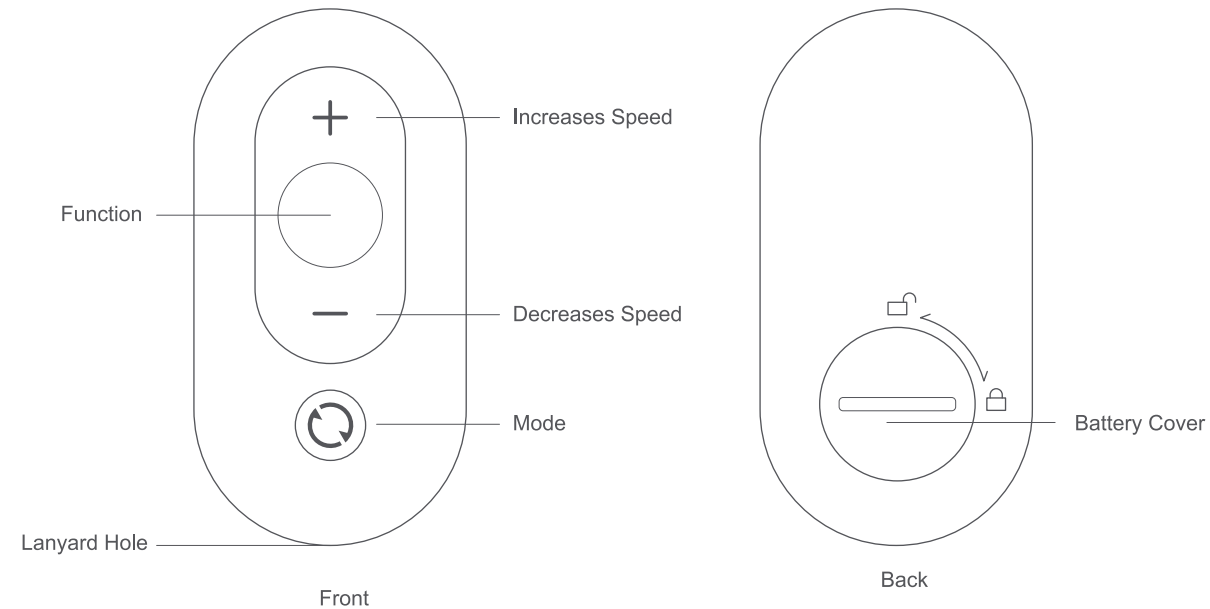

03. Set-Up Guide

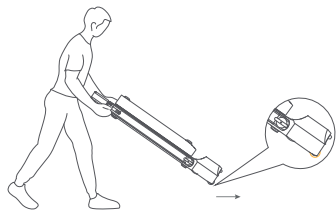

1. When moving treadmill, make sure that all the locking devices on the handrail are locked and fixed. Put the treadmill on a flat and firm surface. Avoid soft or thick carpets.

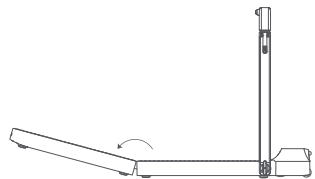

3. Unfold the treadmill, adjust the walking belt to the center position, slowly unfold it and press it down to make it completely flat, or rotate the bottom foot cushion for leveling.

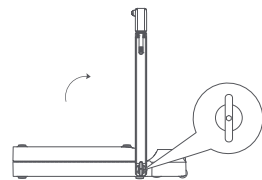

2. Loosen the handrail locking device, lift the handrail to a vertical position, tighten the locking devices on both sides of the handrail.

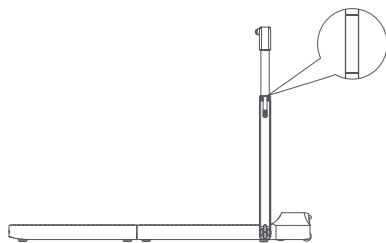

4. Loosen the handrail quick mounting device, adjust it to the handrail scale mark, and then lock the handrail quick mounting device.

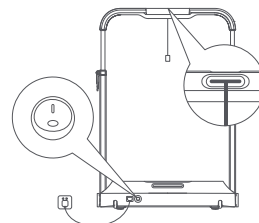

5. Install the emergency stop switch. Connect the power supply and turn on the power switch.

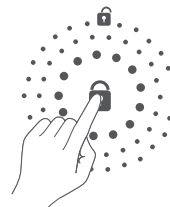

7. Open APP, follow the instructions to add and connect the treadmill, then the treadmill is ready to use.



6. Download "KS Fit" APP from the Apple Store or Google Play Store and complete installation.

04. Learn to Use the Treadmill

1. Mode Description



Standby Mode

The standby mode indicator lights up, the motor and sensor are stopped.



Manual Mode

The manual mode indicator lights up, the speed can be controlled with the remote control or the APP.



Automatic Mode

The automatic mode indicator lights up, the speed is controlled automatically via an intelligent algorithm.

2. Standby Mode Control Description



Standby Mode

Under standby mode, users can press the mode button on the remote control briefly to wake up the treadmill and switch to the default manual mode.

Users can also touch the icon on the display panel to wake up the treadmill.

When the treadmill is not in use, press the mode button on the remote control or touch the standby icon on the display panel to switch to the standby mode.

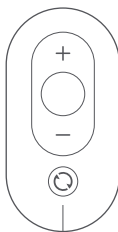

Remote Control Diagram

Short press: Mode switch

Long press: Switch to standby mode (non-operational state)

3. Manual Mode Control Description(primary mode)



Manual Mode

In this mode, users can use the remote control to control the treadmill. Beginners are advised to use the manual mode first, and then use the automatic mode once skills have increased.

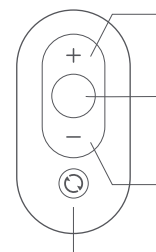

Speed Increase Button

Short press: Speed increased by 0.5 km/h (0.5 mi/h)

Function Button

Short press: Starts or stops the treadmill

Speed Decrease Button

Short press: Speed decreased by 0.5 km/h (0.5 mi/h)

Mode Button

Short press: Switches mode

Long press: Switch to standby mode(not in use)

04. Learn to Use the Treadmill

4. Automatic Control Mode Description



Automatic

This mode is difficult to control and can be used completely without the remote control. It is advised to use this mode only after having gain experience.

Use the remote control to start and stop the treadmill, and the switch mode button is effective under this mode.

Note: The automatic control mode is only available under walking mode.

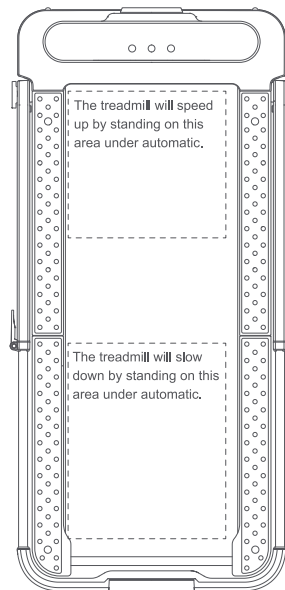

05. Trademark and Legal Notice

5. Remote Control Pairing Instructions

If the remote control does not respond or you have replaced the remote control, you need to pair it again.

Pairing method: Restart the treadmill and press and hold the Mode button on the remote control **AT THE SAME TIME** for 5 seconds.

6. Connection Caution Light

Not connected to APP: Will flicker

Connected to APP: Off

7. Fault Caution Light

E01: Software overcurrent

E02: Hardware overcurrent

E03: IPM Module Overheating

E04: Low-voltage Protection

E05: High-voltage Protection

E06: Motor phase loss protection

E07: Motor block rotation protection

E08: Sensor fault

E09: Motor unable to start

E12: Motor overcurrent

protection

E13: Overloading protection

E14: Hall signal loss

E15: Communication fault

The patents involved in Kingsmith WalkingPad Treadmill series products are made by Beijing Kingsmith Technology Co., Ltd. and owned by the Company. No organization or individual may copy, distribute all or any part of this manual without Kingsmith's written permission, and may not use these patents without authorization.

When printing this manual, we have put various functional descriptions and instructions in it as far as possible.

However, due to the continuous improvement of product functions and design changes, there may still be discrepancies with the products you purchased. Due to product update, this manual may deviate from the actual product in terms of color, appearance, etc. Please refer to the actual product.

06. Safety Instruction

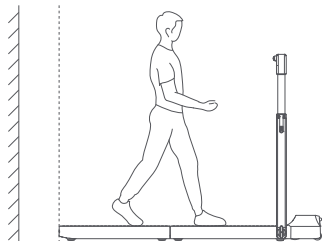

- ⚠ The distance behind the treadmill should be superior to 2000 mm. You can hold the handrail tightly to support your body and jump away from the treadmill.

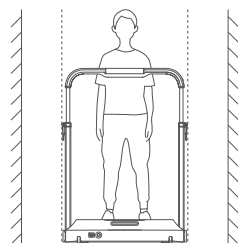

- ⚠ The distance on each side of the treadmill should be superior to 500 mm.

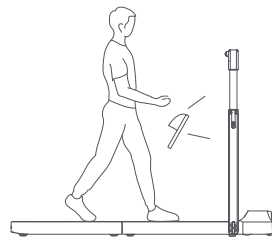

- ⚠ Please wear sports shoes and clothes and exercise moderately when using the treadmill. If you feel uncomfortable during running, please stop immediately and consult a doctor. Otherwise, you may risk injuries.

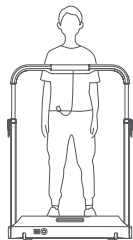

Actuator release force: 7N
Clip release force: 18N

- ⚠ Test the safe lock before using the treadmill. Please clip the end of the safe lock on your clothes when running on the treadmill. If there is an unexpected situation, pull off the safe lock to stop the treadmill immediately.

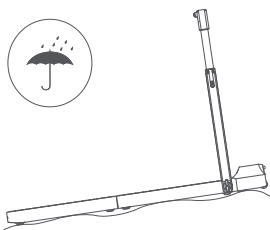

- ⊗ Do not operate the treadmill in damp or wet locations. Do not use it on irregular ground.

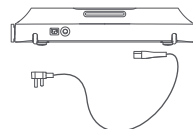

- ⚠ Please unplug the power cord when not in use.



- ⊗ Do not step on the head of the treadmill.



- ⊗ Do not bring pets when using the treadmill.

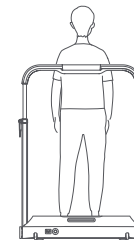

- ⊗ Do not use the treadmill backwards or sideways.

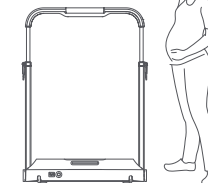

- ⚠ Elderly people, children, and pregnant women should use caution when using the treadmill.

06. Safety Instruction

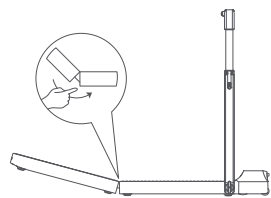

⚠ Watch your hands.

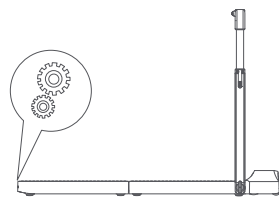

⚠ Take care of your belongings.

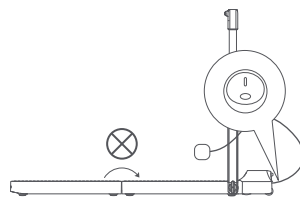

⊗ Do not fold before power off.

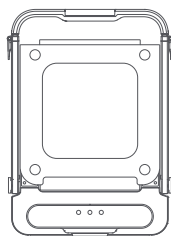

⚠ Keep treadmill upright and put it in a space with supporting points on both sides. Please keep away from children.

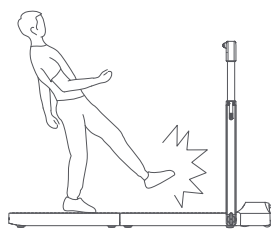

⊗ Do not get on and off when the treadmill operating.

07. Maintenance and Adjustments

1. Clean the treadmill

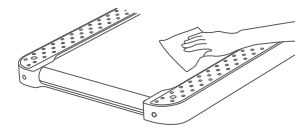

- Disconnect all sources of power before cleaning the treadmill.
- Add a small quantity of mild cleaner to a 100% cotton cloth. Do not spray the cleaner directly on the walking belt or use acidic and corrosive cleaner.
- Do not wipe under the walking belt.
- After a period of exercise, dust and stains may appear on the rear floor. This is normal and can be simply wiped.

2. Walking Belt Slipping and Correction

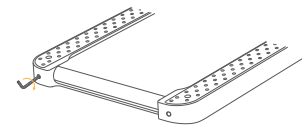

- Simultaneously press and hold both Mode Button and Speed Increase Button on the remote control for over 3 seconds until device start.
 - Front panel will show "CALI" and keep running with speed 3km/h (2mi/h).
 - Walking belt goes to the left: Turn the left adjusting hole screw clockwise by 1/4 turn.
 - Walking belt goes to the right: Turn the right adjusting hole screw clockwise by 1/4 turn.
 - Walking belt is slipping: Turn the left and right adjusting screws clockwise for 1/2 turn at the same time.
 - After each adjustment, the treadmill needs to run for 1-2 minutes to verify the adjustments. Please adjust again if necessary.
 - Press the function key to stop treadmill.
- CAUTION: DO NOT OVERTIGHTEN THE BELT. PLEASE MAINTAIN ORIGINAL FACTORY BELT TENSION. EXCESSIVE BELT TENSION WILL CAUSE DAMAGE TO MOTOR.**

3. Walking belt lubrication

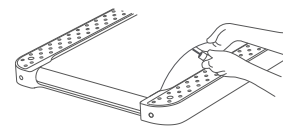

- Power off the treadmill and unplug the power cord.
- Lift the edge of the walking belt and smear the inner surface with silicone oil.
- Start the treadmill to run at a speed of 3 km/h (2 mi/h) for 10-20 seconds.
- 5-10 ml of silicone oil is required for each lubrication. Excessive silicone oil may cause slipping and affect normal use.
- Lubricate the walking belt every three months.

08. Replacement and Disposal



The battery contained in this appliance must be removed for disposal.

When replacing the battery, use only original battery, available from our online parts shop.

The battery compartment is located on the back of the appliance. Open the compartment by removing the screw in the cover using a suitable screwdriver, and then press the lower end of the locking catch on the connectors. In that way, both sides of the connection can be separated by pulling them apart.

When inserting a new battery, push together the two connectors and ensure that the catch locks over the stop.

Never dispose of old battery in domestic garbage, but only through the proper public collection points. This also applies to the battery of defective appliances.



Devices marked with this symbol must be disposed of separately from your household waste, as they contain valuable materials that can be recycled. Proper disposal protects the environment and human health. Your local authority or retailer can provide information on the matter.