













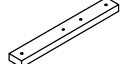

ASSEMBLY INSTRUCTIONS

Model: PCS-150-1

COMPONENT LIST

NO.	Drawing	Description	QTY
A		TOP PANEL	1PC
B		TRIANGLE	1PC
C		FRONT PANEL	1PC
D		LEFT SIDE PANEL	1PC
E		RIGHT SIDE PANEL	1PC
F		BOTTOM PANEL	1PC
G		WOOD CLEAT	2PCS
H		WOOD BLOCK	4PCS

HARDWARE LIST

1		Allen Wrench 4 mm	1PC
2		Allen Bolt 1/4" x 32 mm # 13	19PCS
3		Flat Washer 8 x 16 x 1 mm	19PCS
4		Wood Dowel Ø8 x 30 mm	15PCS
5		Screw 1/4" x 25 mm	12PCS
6		Screw 1/4" x 50 mm	4PCS

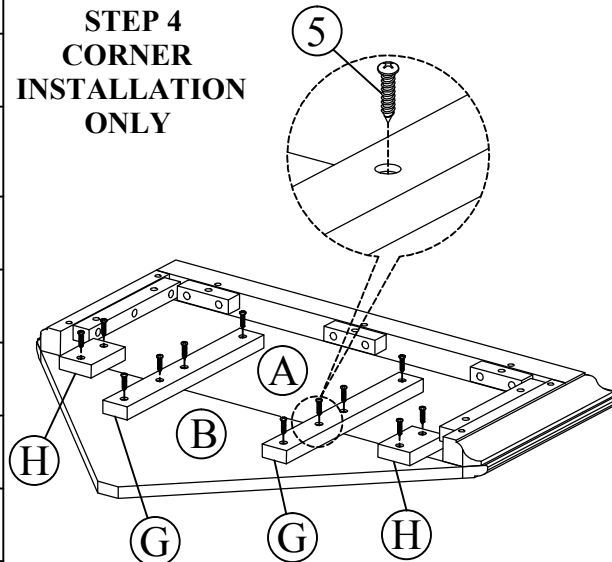
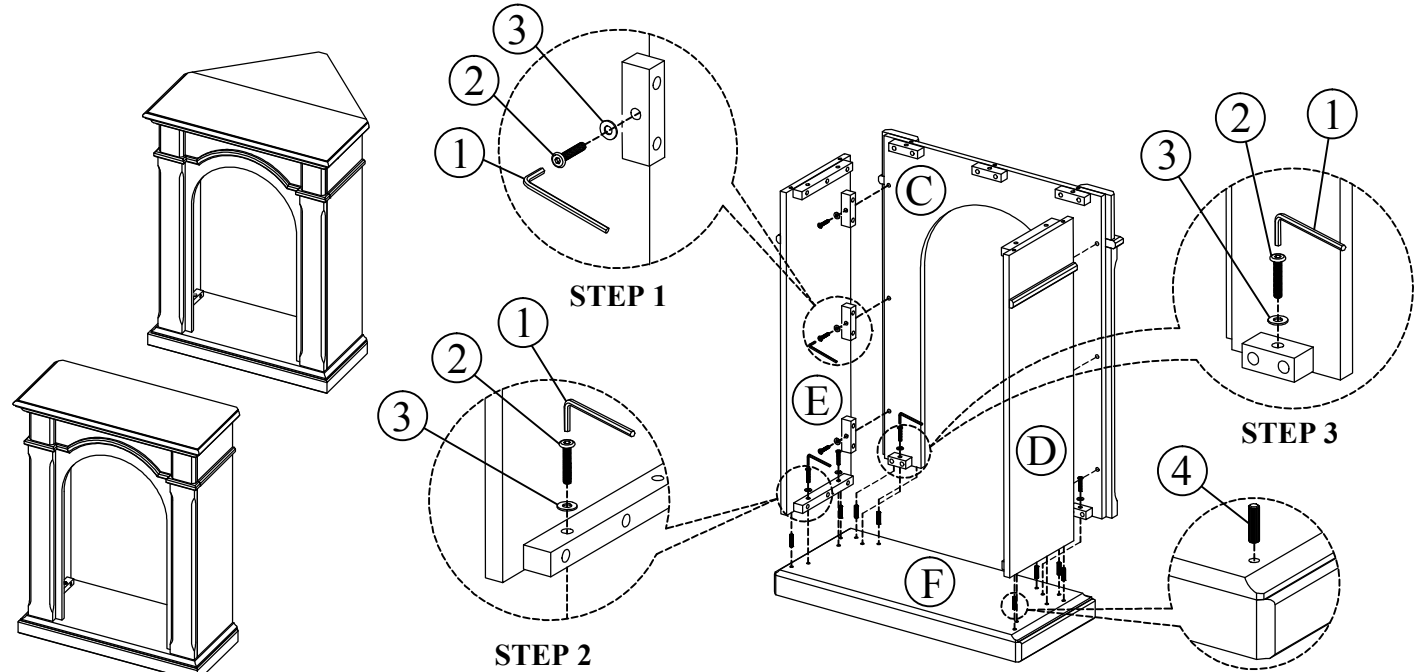

STEP 5

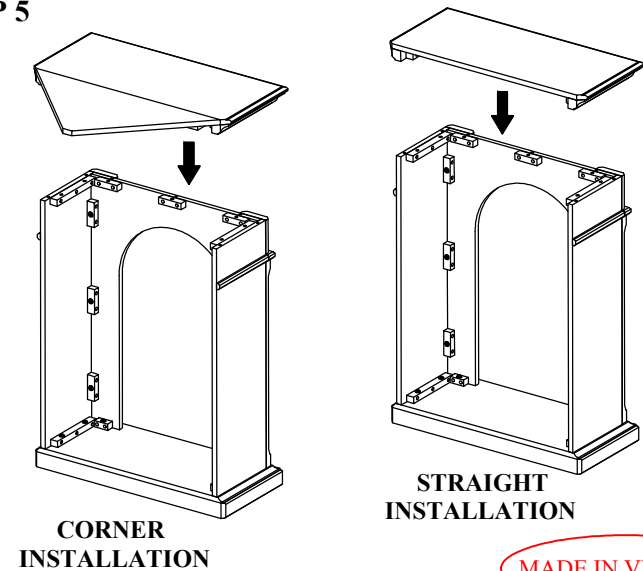

ASSEMBLY INSTRUCTIONS

Model: PCS-150-1

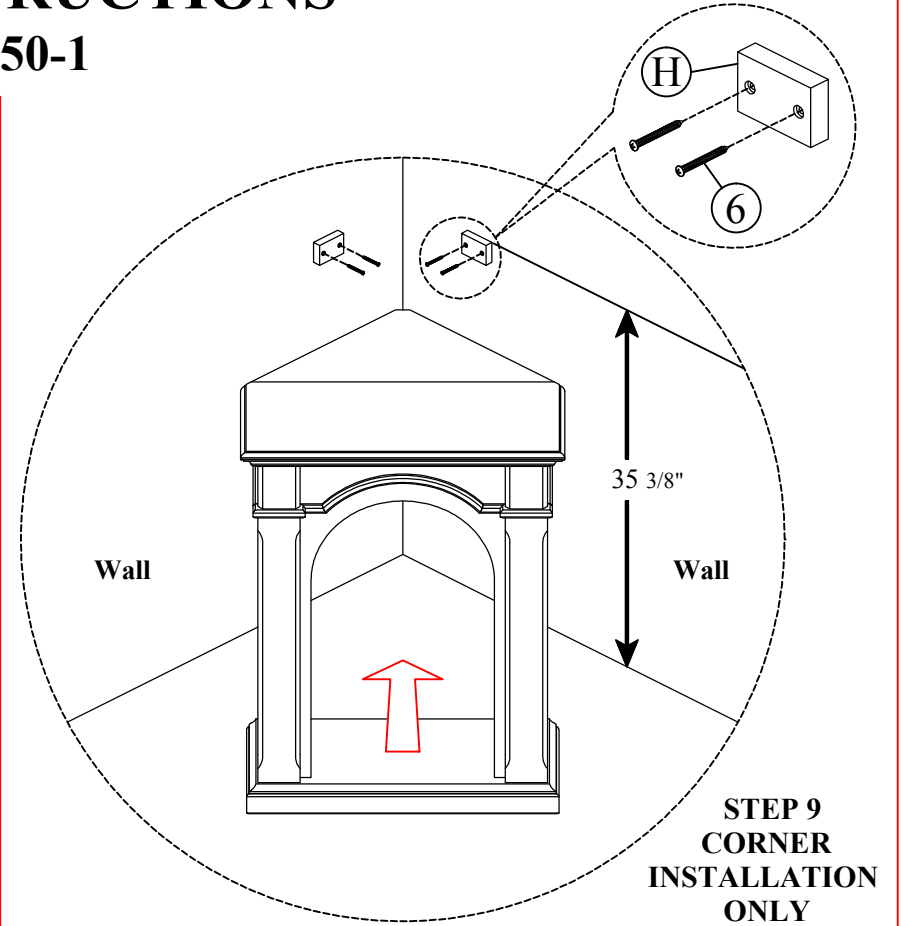
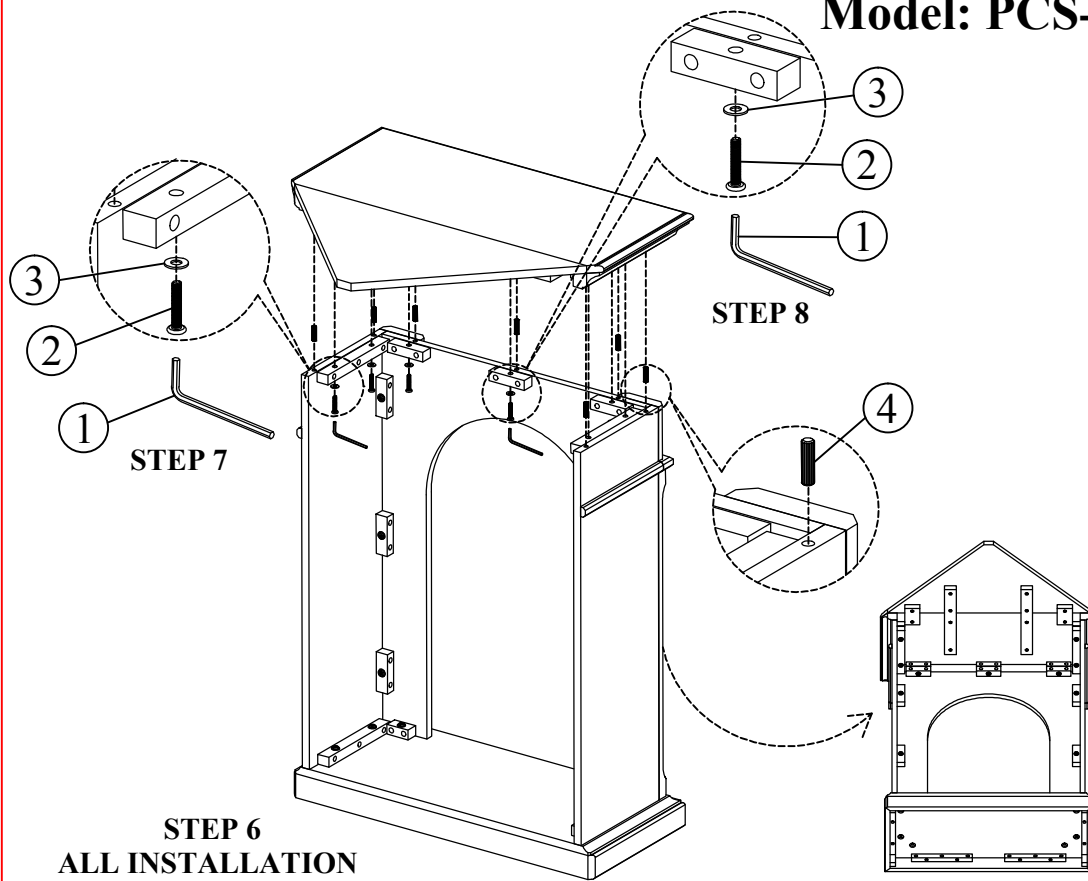

**CORNER
INSTALLATION**

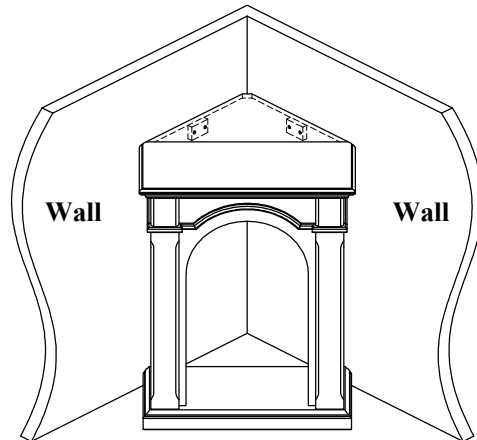

Wall

**STRAIGHT
INSTALLATION**

