

MICRO SLOT RACING

MOVIE CHASE



Please read user manual carefully before use.
Keep this instruction sheet for future reference, as it contains important information.
Adult supervision required. Contains small pieces.
www.jupitercreations.com

Instruction Manual Item# 20004

Watch Micro Slot Racing care instruction video:



Jupiter Creations

Layout

Step 1: Connect track pieces together as shown below. Don't apply too much pressure when connecting the track pieces which can cause the connecting prongs to break.

Note: Base can be placed anywhere: You can place them on the center of the track like the diagram below, or on the outside of the track.

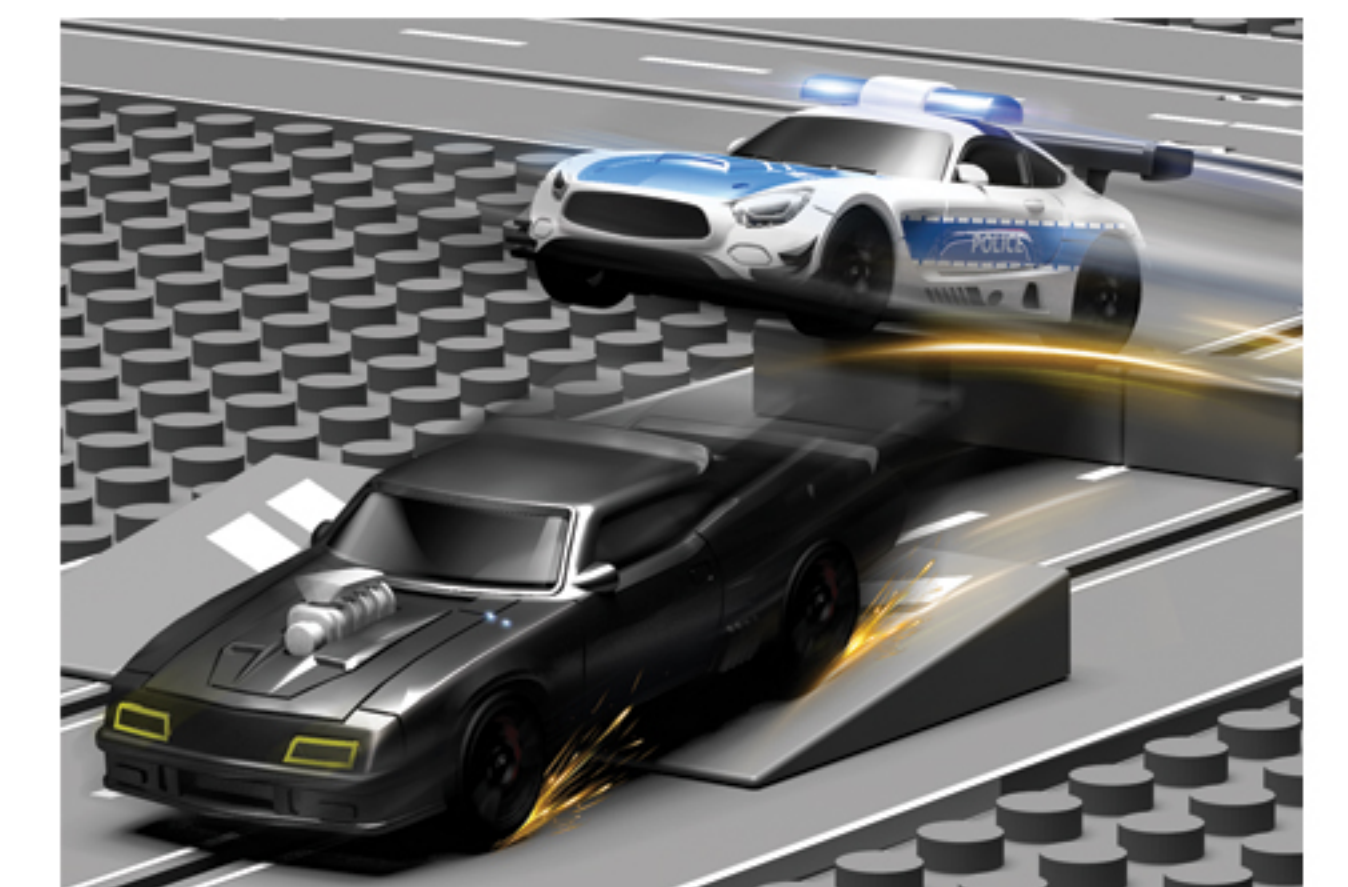
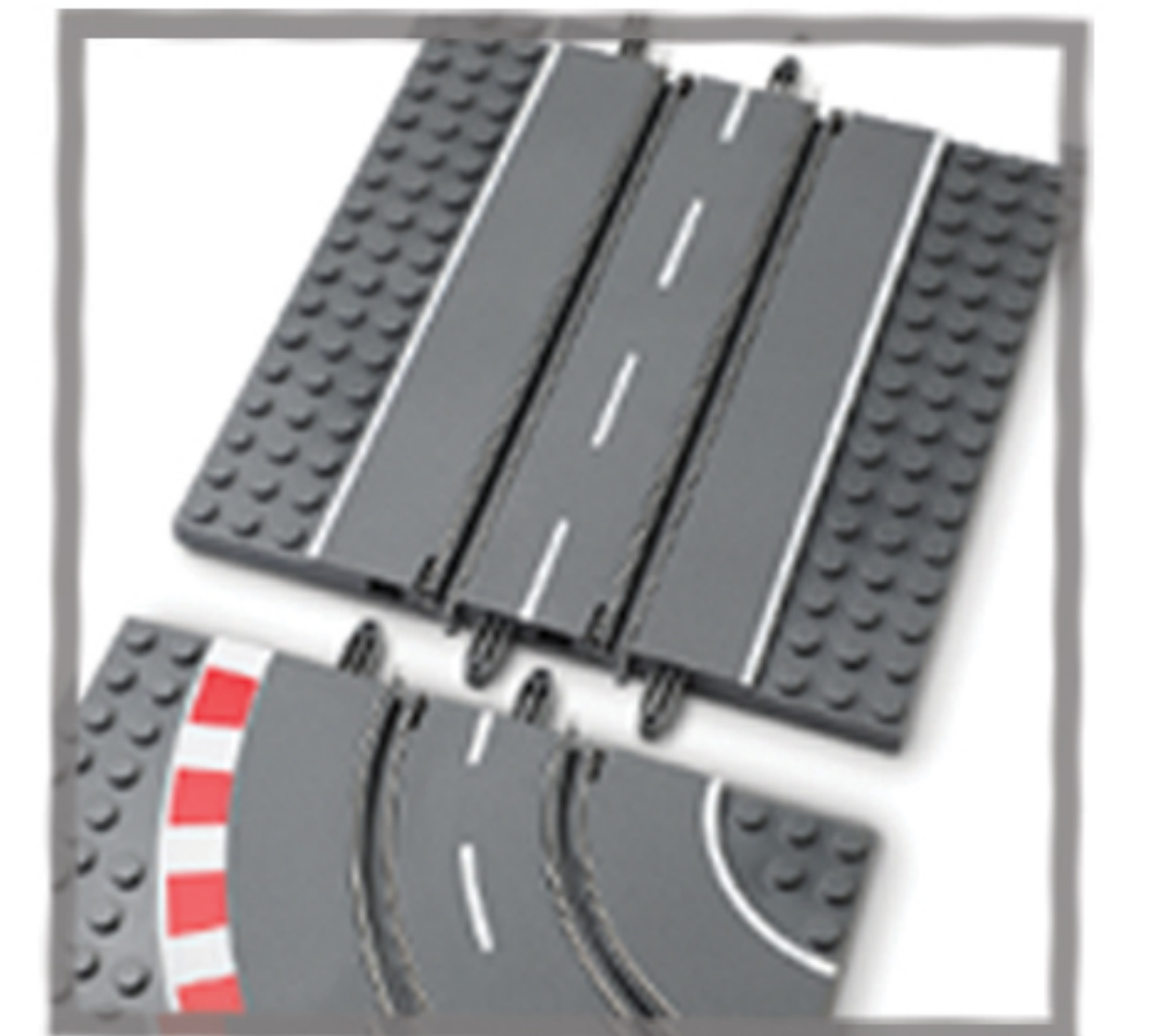
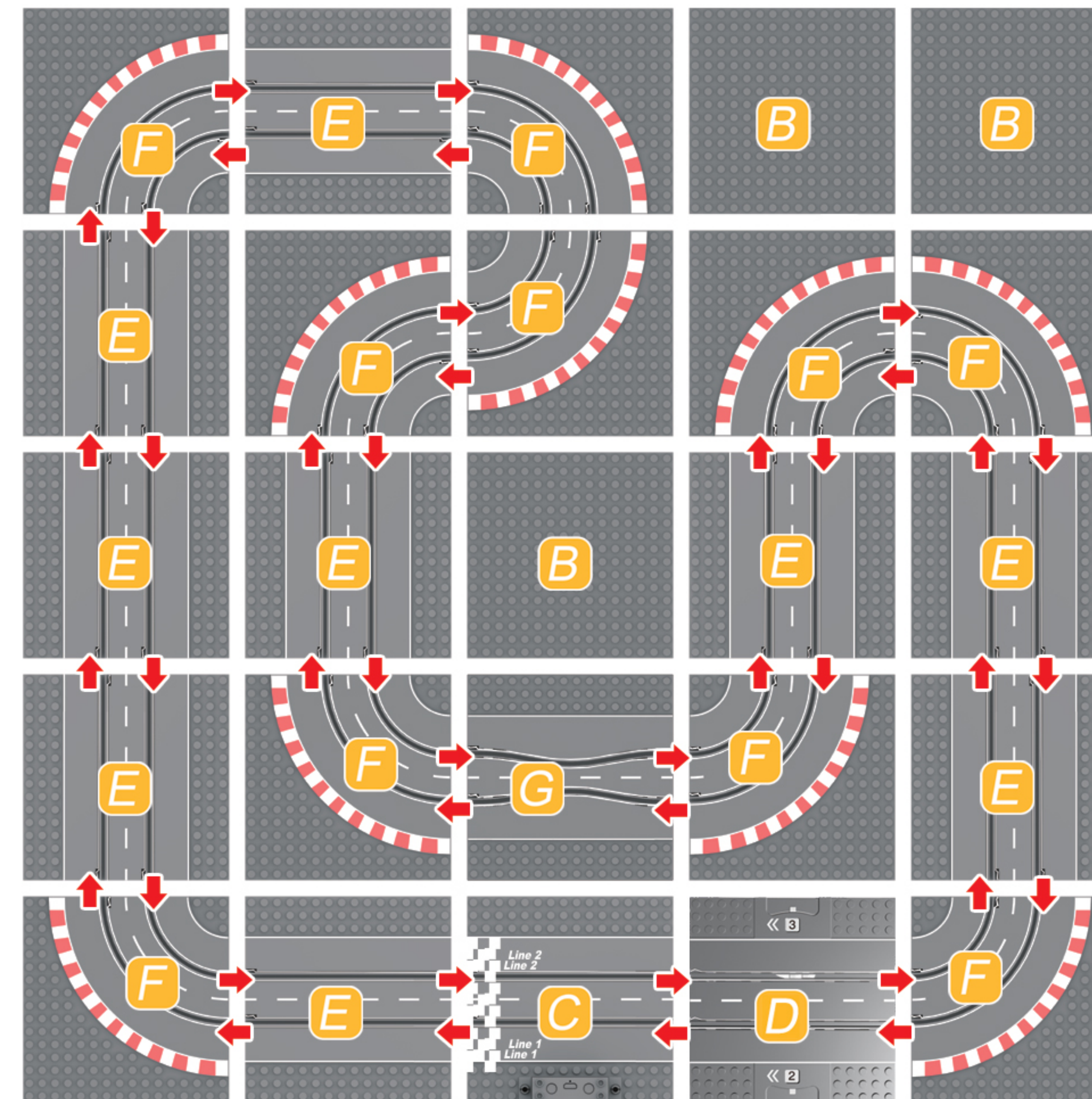

The stunt jumps can be placed anywhere on the track. Test the distance between take off and landing pcs as the cars jump farther the faster they go.

Step 2: Assemble start gate and flags.

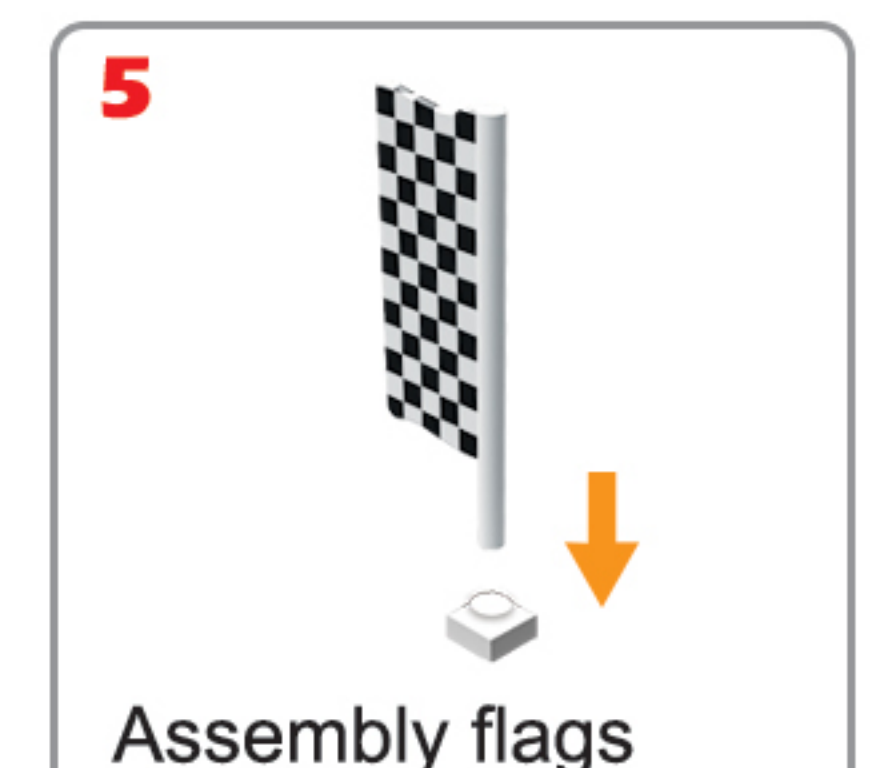
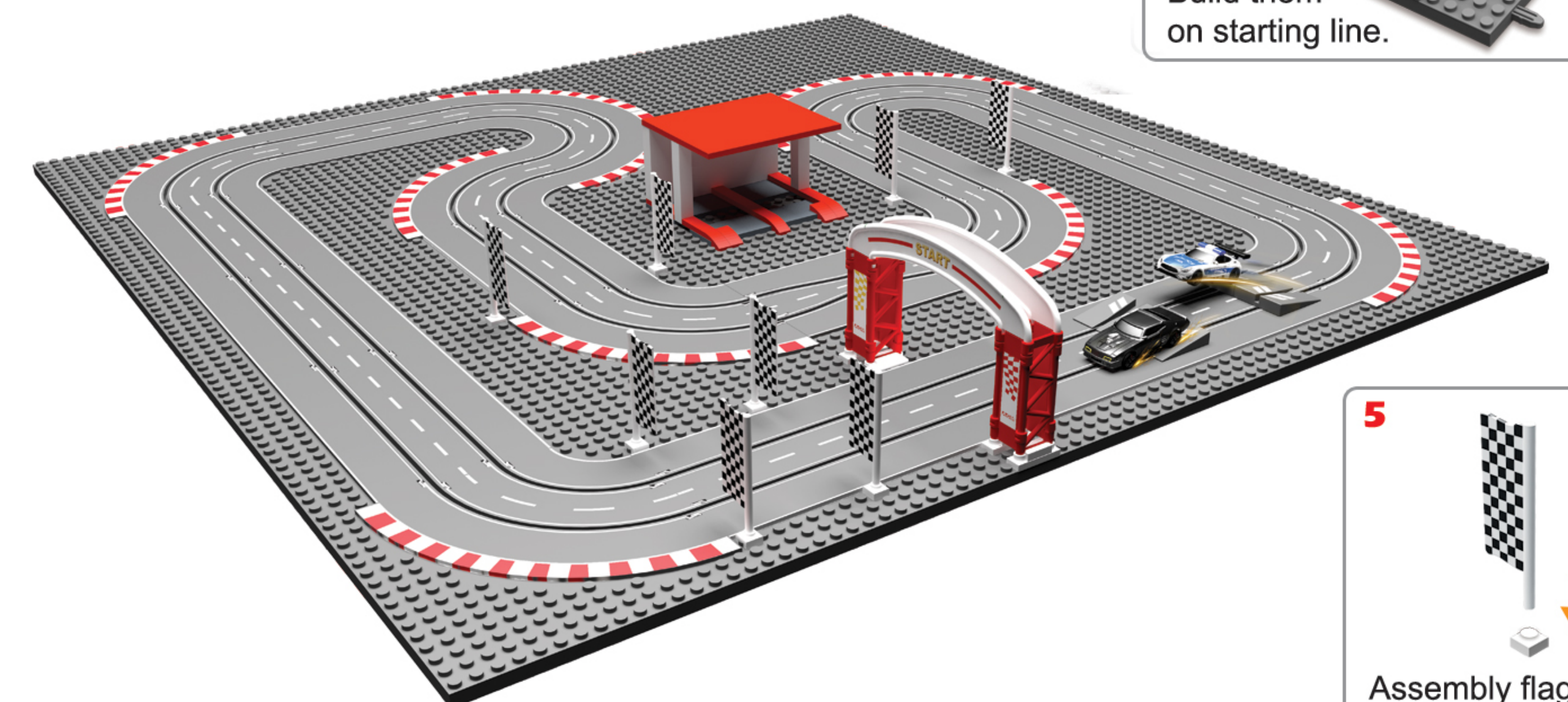
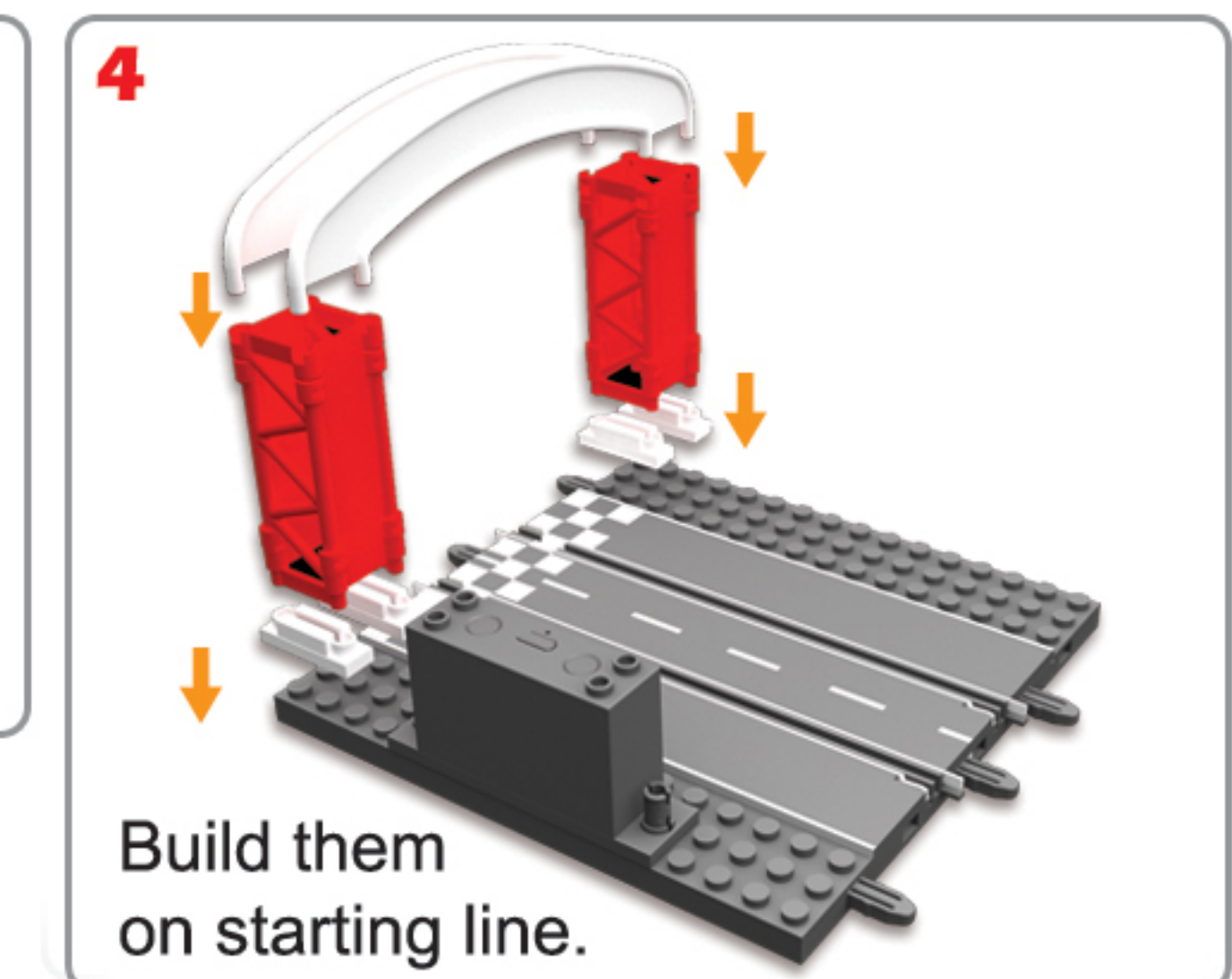
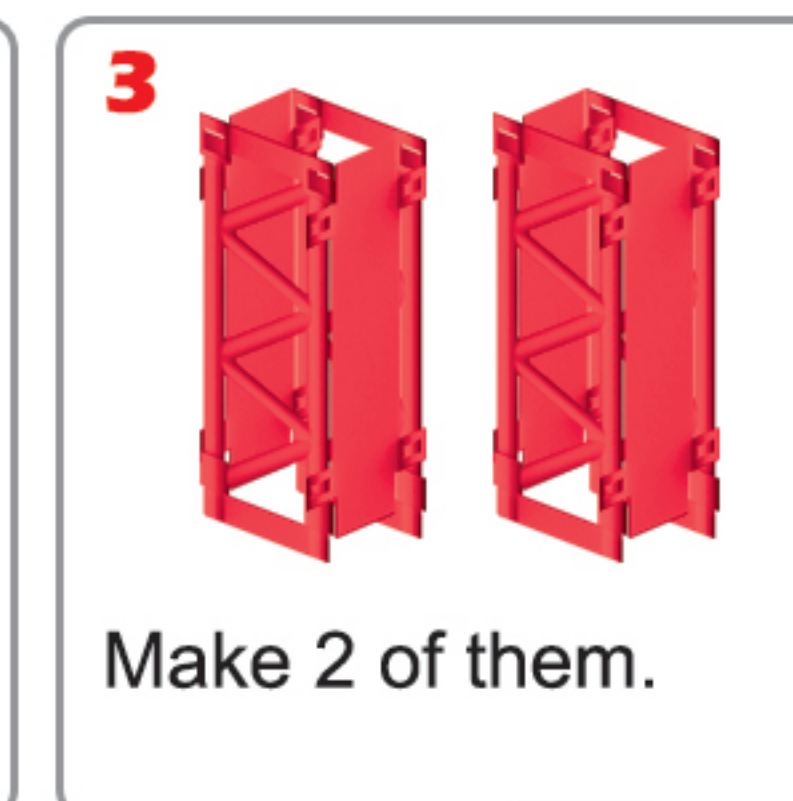
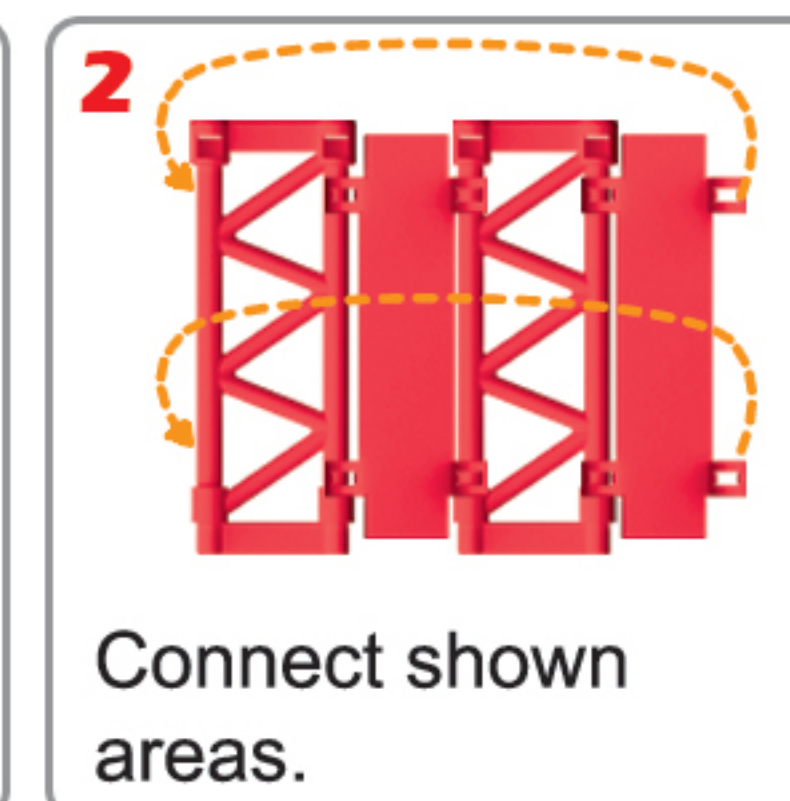
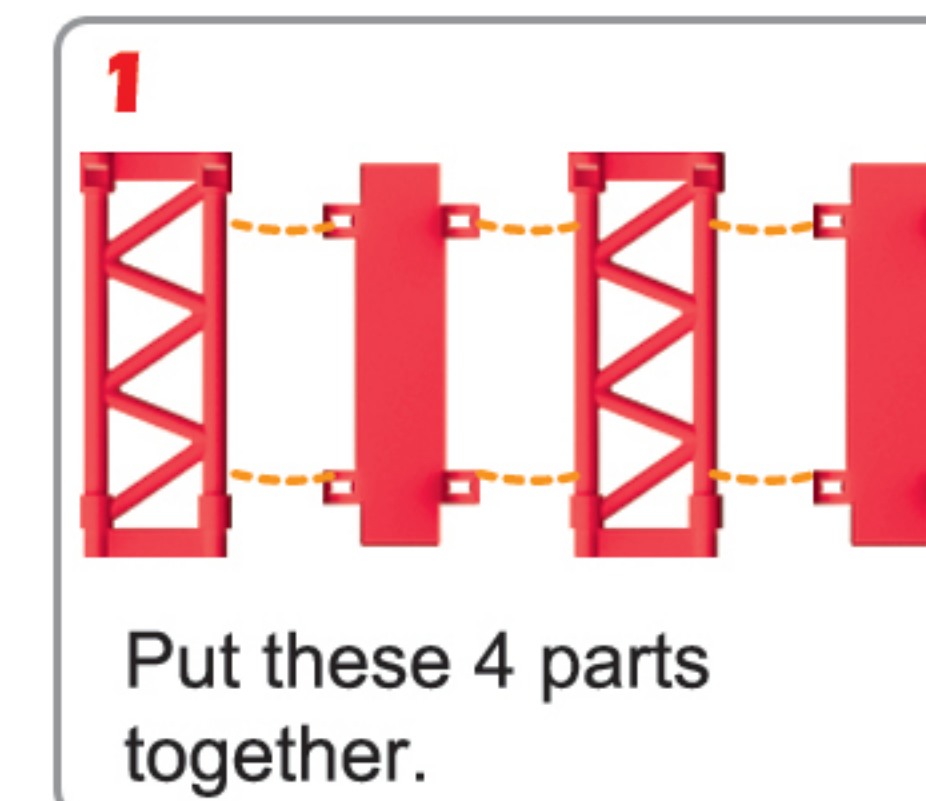

Contents



Car x2



Controller x2

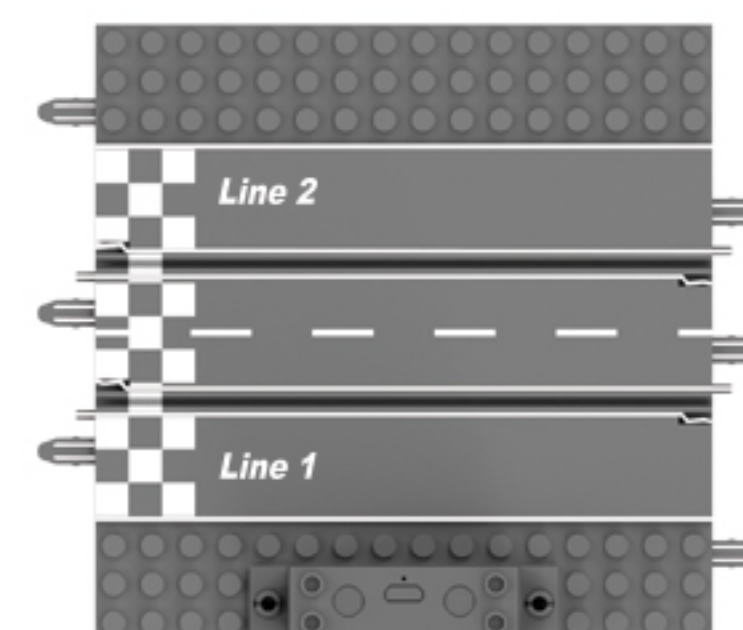

C Control box x1

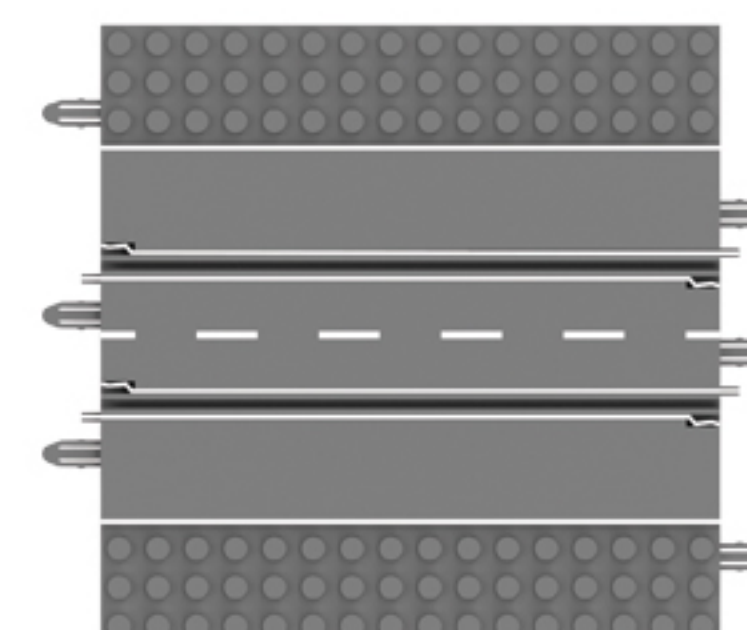

E Straight track x10



USB wire x1



Flag x8



Start gate x1

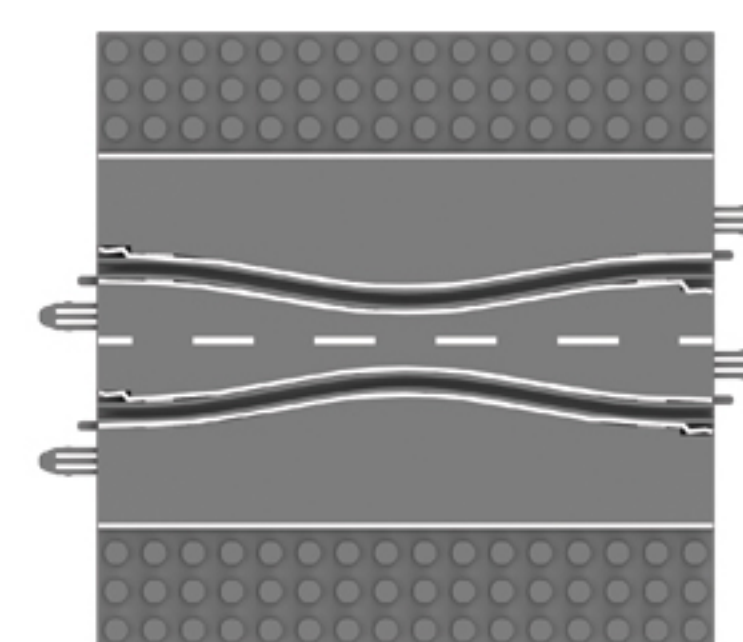

G Narrow track x1

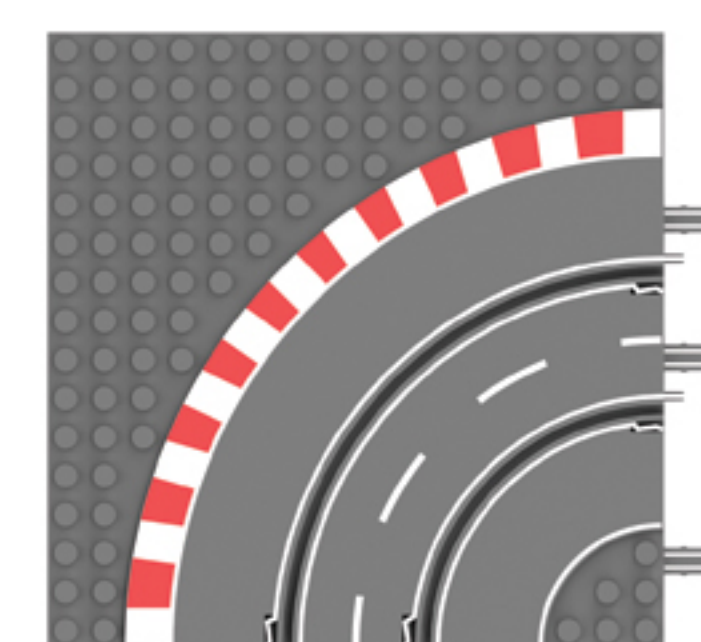

F Curve track x10

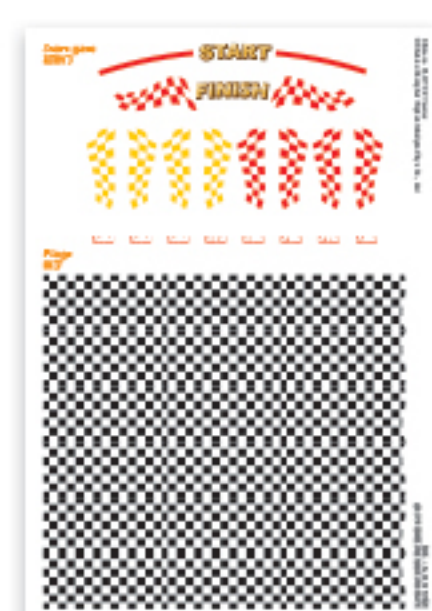

Sticker x1



StuntJump x2

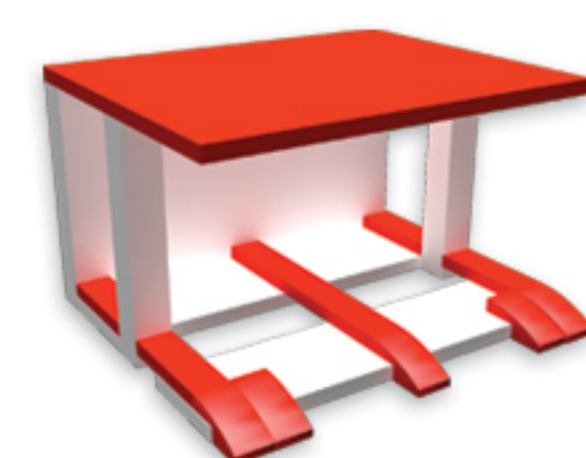

Parking shed x1

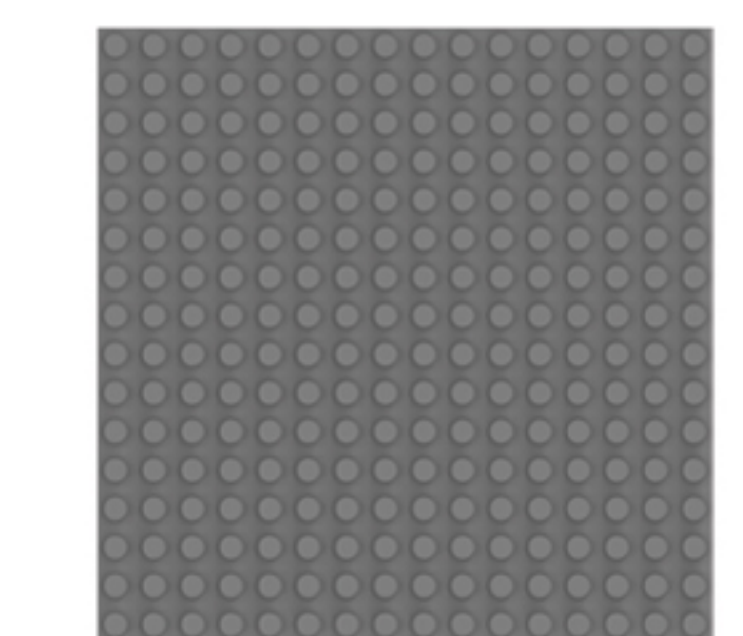

B Base x3

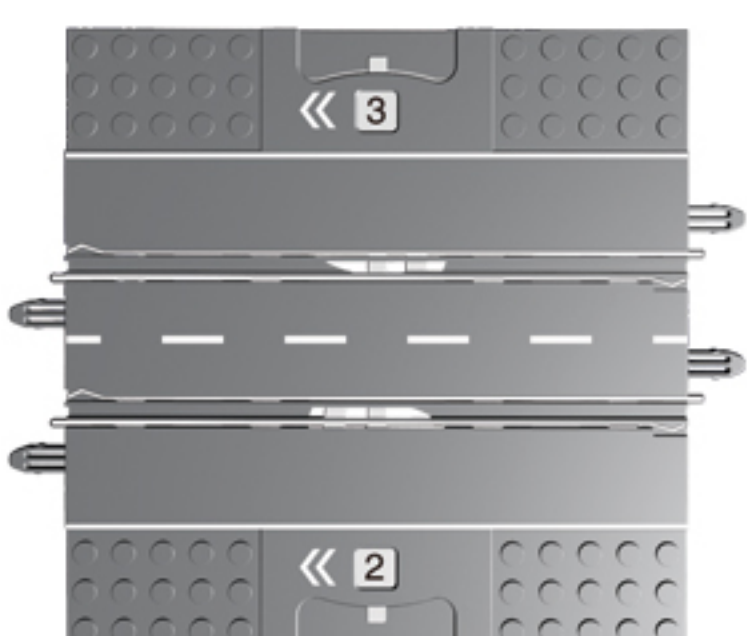

D Lap counter x1

How to use

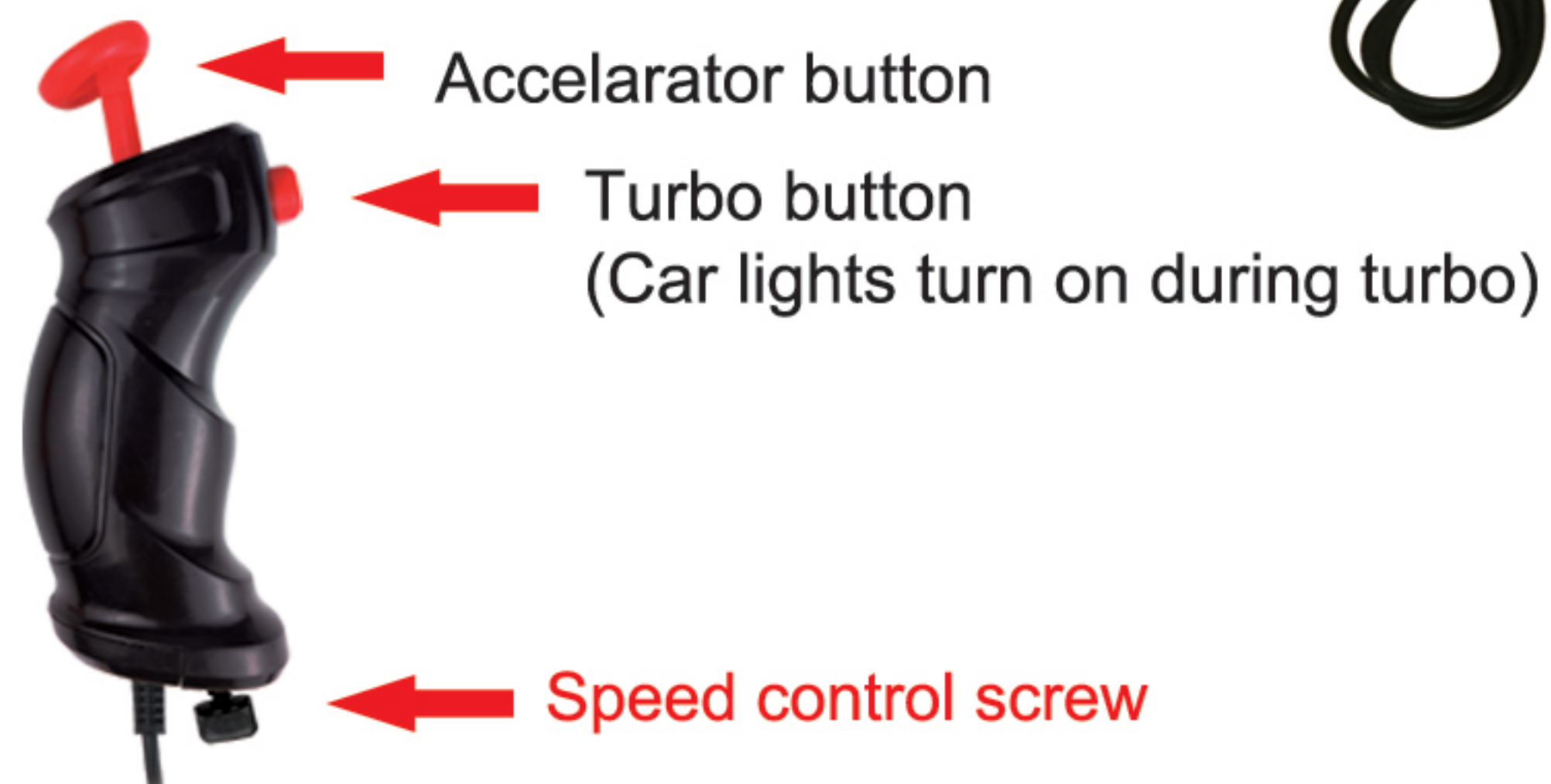
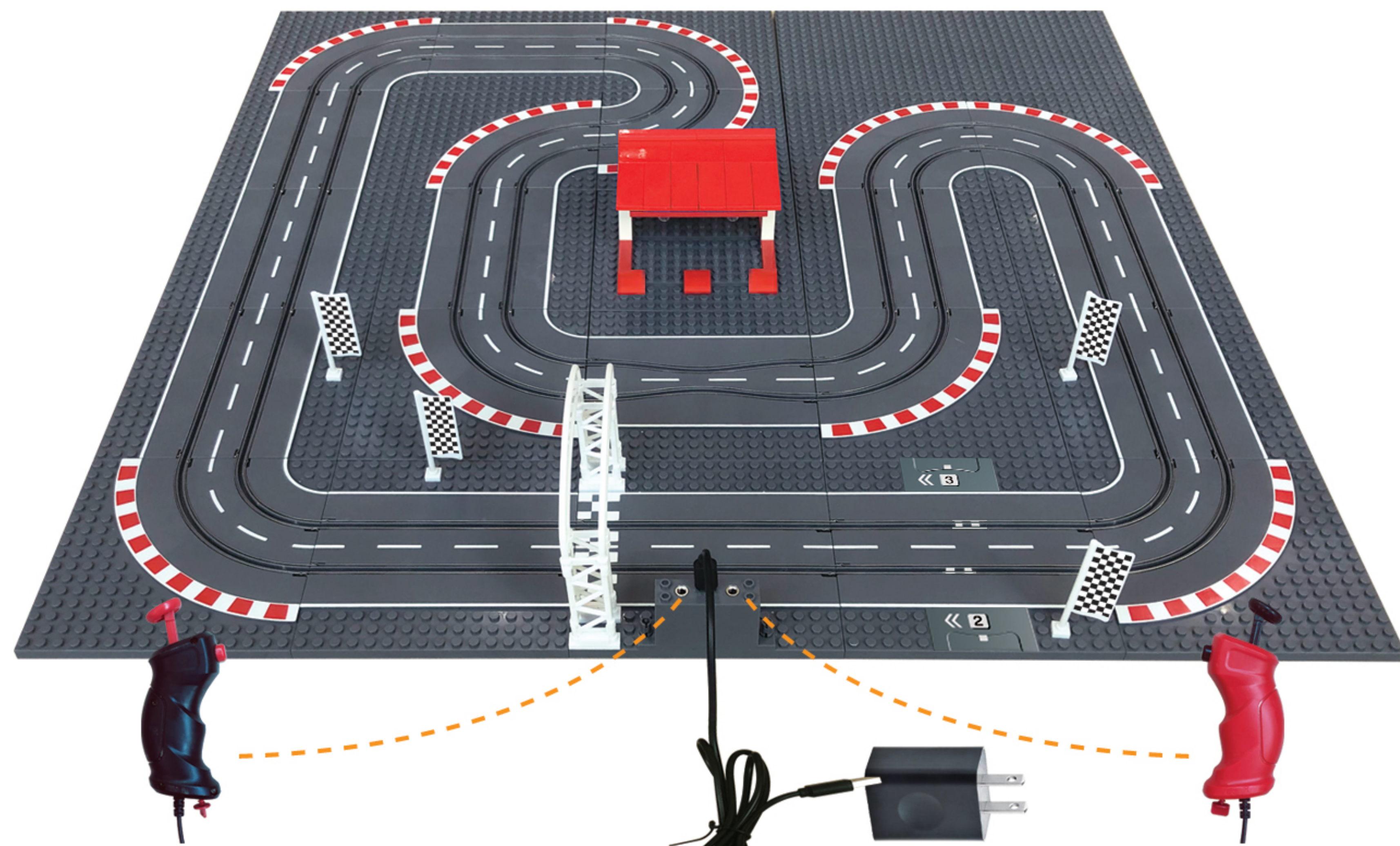

Chord included.
USB charger
Not included

Maintenance :
Please wipe the rail thoroughly
with a clean cloth to make sure
it functions properly

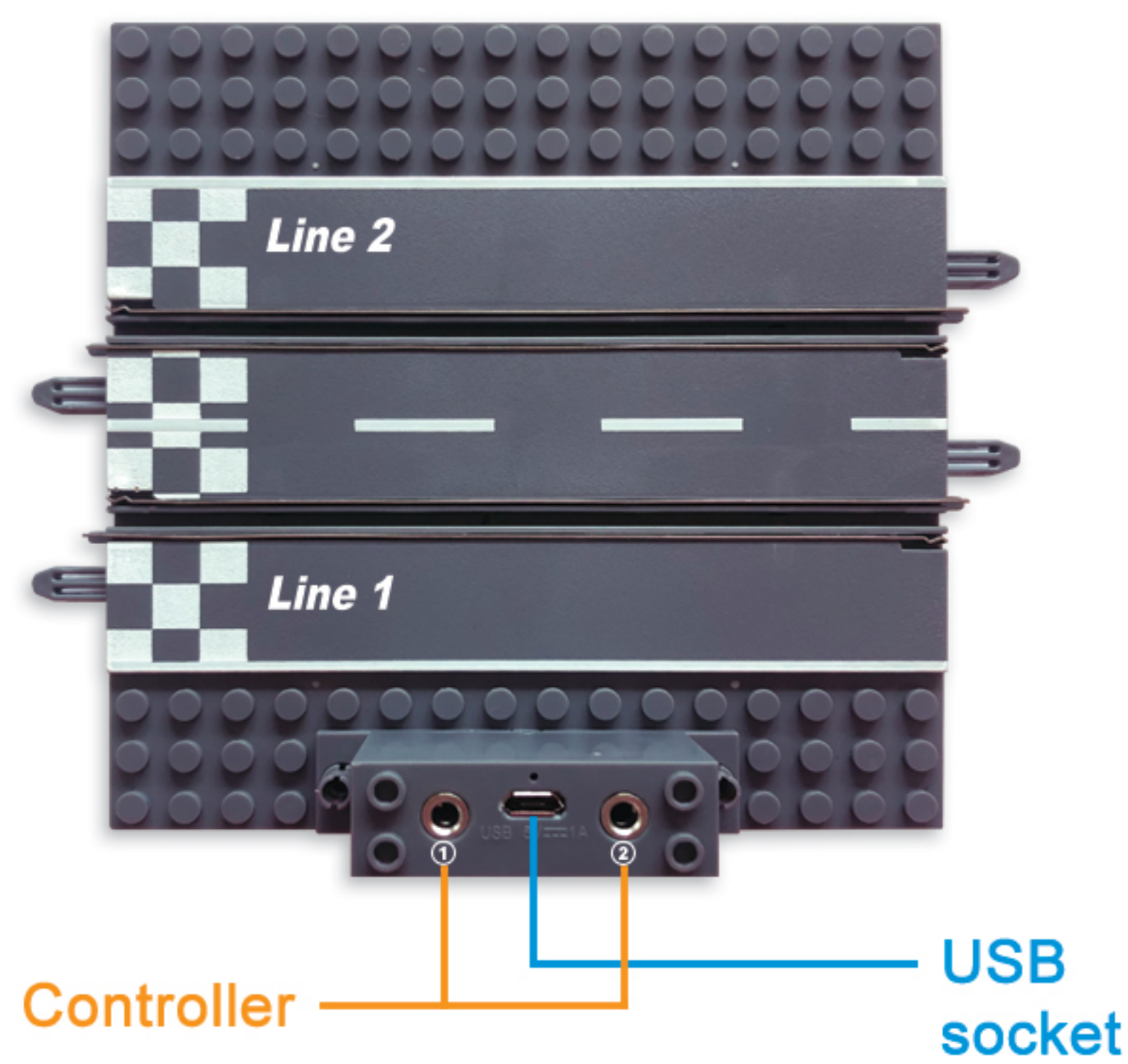

- **Marks description**
- 1. USB wire can only connect to charger / portable charger / USB power strip with Output of 5V 1A or up.
(Not included in product)
- 2. Socket ① controls Line 1
Socket ② controls Line 2

● Speed control screw

There is a **SCREW** on the bottom of the controller that can adjust top speed of car.



Twist **COUNTER CLOCK WISE** to increase top speed.
Suitable for player or players older than 8 years old.



Twist **CLOCK WISE** to reduce top speed.
Suitable for beginners or players younger than 6 years old.



Garage assembly

