

1. BEFORE YOU BEGIN

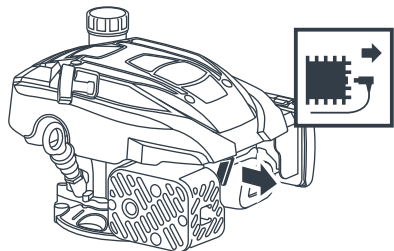

1. Disconnect spark plug wire from spark plug and place wire where it cannot come in contact with plug.



2. Completely drain fuel from tank, wipe off any spilled fuel from lawn mower or side of engine.

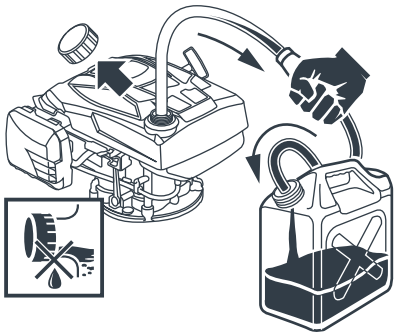

3. Always keep the air filter and carburetor facing up whenever needed to tip the machine onto its side.

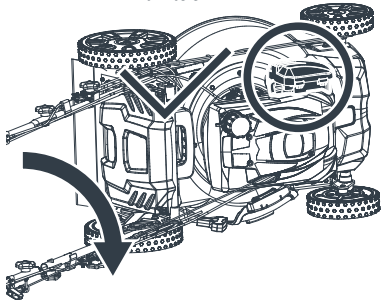

2. REMOVE THE BLADE



1. Wedge a block of wood between the mower blade and the deck.

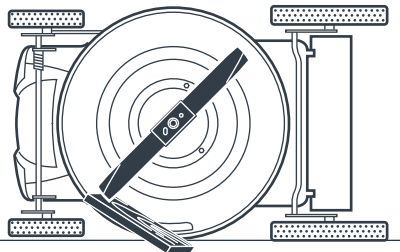

2. Loosen the blade bolt.



3. Remove the blade, saving all mounting hardware.

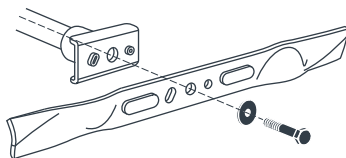

3. INSTALL NEW BLADE



1. Put all mounting hardware and new blade back in position. And wedge a block of wood between the mower blade and deck.

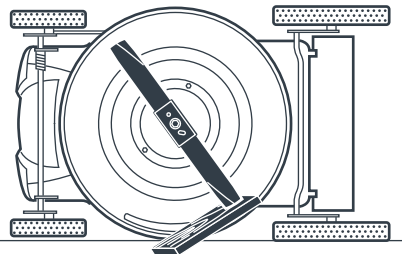

2. Tighten the blade bolt to 33.3 - 40 ft.-lb. (45-55 Nm) using a torque wrench.

Recommended torque
33.3 - 40 ft.-lb.

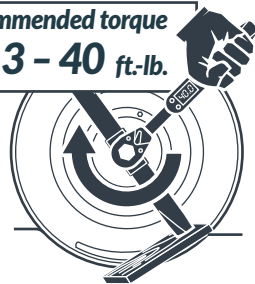

3. Remove the wood block, turn the mower back to upright position. Refill the fuel tank. Re-attach the spark plug wire to the spark plug.