

You have the option of installing your shelf alone (Option 1), shelf with corbels (Option 2), or shelf with corbels and arch (Option 3).

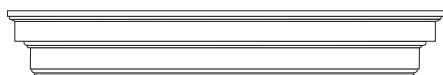

Option 1

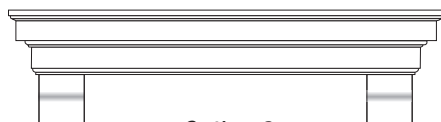

Option 2



Option 3

If you decide not to use the corbels, please proceed to **Installation using the Hanger Board**

### How to attach the corbels

Your shelf has 2 wooden nut plugs placed at each end of the bottom of the shelf for the corbels.

1. Turn the shelf upside down on a soft surface.
2. Tap out the wood nut plugs using a flat head screw driver and hammer (Figure A.) You will be left with 2 holes on each end of the shelf. If you will be attaching the center arch (see below), the side nut plugs on each corbel must also be tapped out and face the arch in the center of the shelf.
3. Put the washers onto the bolts.
4. With the shelf still upside down line up the pre threaded inserts of the corbels with the holes in the bottom of the shelf. (Figure B.)
5. Before installing, insert the bolts through the holes in the bottom of the shelf and tighten into the threaded inserts.

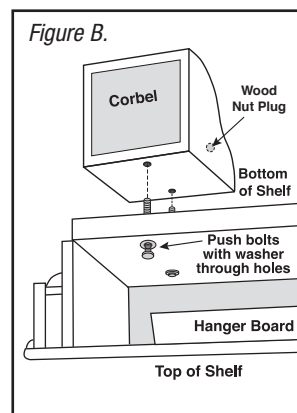
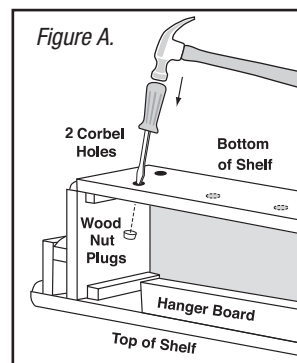

### How to attach the arch

Your shelf has 4 wooden nut plugs placed in the back of the bottom shelf and one on the side of each corbel for the arch.

1. Turn the shelf upside down on a soft surface.
2. Tap out the wood nut plugs using a flat head screw driver and hammer (Figure C.) You will be left with 4 holes along the back of the shelf, and one on the side of each corbel. Make sure the hole side of each corbel faces the arch in the center of the shelf.
3. Put the washers onto the bolts.
4. With the shelf still upside down line up the pre threaded inserts of the arch with the holes in the bottom of the shelf and sides of corbels. (Figure D.)
5. Before installing, insert the bolts through the holes in the bottom of the shelf and corbels, and tighten into the threaded inserts.

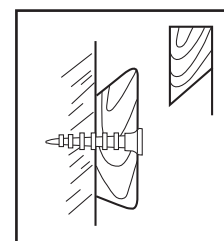
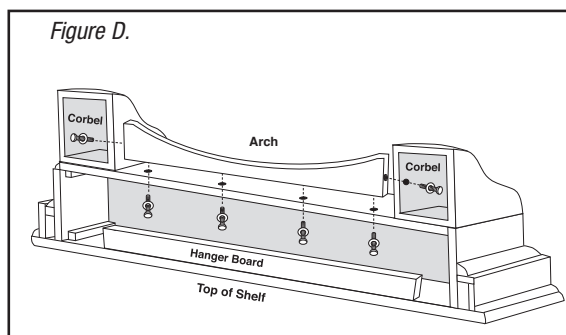
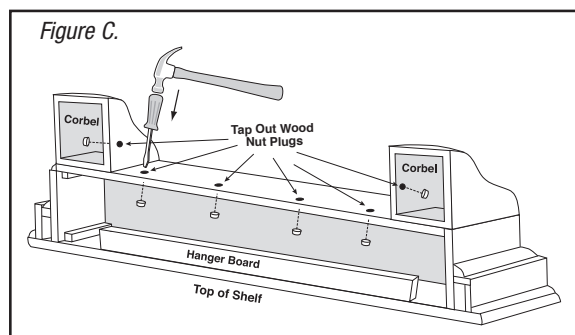

### Installation using the Hanger Board

For hanging your shelf, we suggest that you use the hanger board included in this box.

The type of hardware (not included) you will use for mounting your hanger board will depend upon the medium your shelf will be attached to (i.e. brick, stone, drywall...). Please consult a professional for advice on the proper hardware.

### Measuring

The hanger board measurement should be taken from the floor or the hearth to the bottom edge of the hanger board. Mark your recorded measurement on your wall, both left and right. Take the wall hanger board and mount it on the wall so that the bottom edge of the board is on your recorded marks. Check to see that your wall hanger board is centered over your firebox before mounting.

Once mounted, if the shelf doesn't seem to fit snugly to the wall, you may put a small shim of paper, cardboard, etc., to fill the gap where the 2 halves of the hanger board meet.

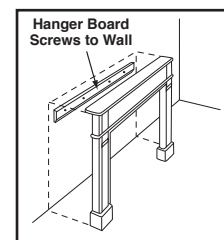

### Suggested Preparation Prior to Painting or Staining of Wood Mantels

Lightly sand your shelf before painting or staining. Wipe clean. Use a solvent to remove any excess glue. If painting, we suggest that a primer be used before applying your top coat. We also suggest that you follow the paint/stain manufacturer's recommendations for application.

*The hanger board is only a suggested method. Your installer may also have additional methods for mounting your mantel or shelf.*

*We suggest that pilot holes be drilled prior to inserting the appropriate hardware for final installation on the wall surface.*

**Wood and MDF mantels are considered combustible materials. Heat clearances must be adhered to. Before installing, check your local building codes and the manufacturer's instructions for your specific fireplace insert or stove.**