



ASSEMBLY INSTRUCTIONS

Pour le français, voir la page 2. Para el español, ver la página 3.

8' x 10' STORAGE SHED

MODEL 60371

BEFORE ASSEMBLY:

- Assemble on a level platform
- At least 3 people recommended for setup
- Inspect all parts and hardware. Ensure all are included using the *Parts Identifier* in the middle of these instructions. The *Parts Identifier*, in yellow, can be removed from the instructions for quick reference

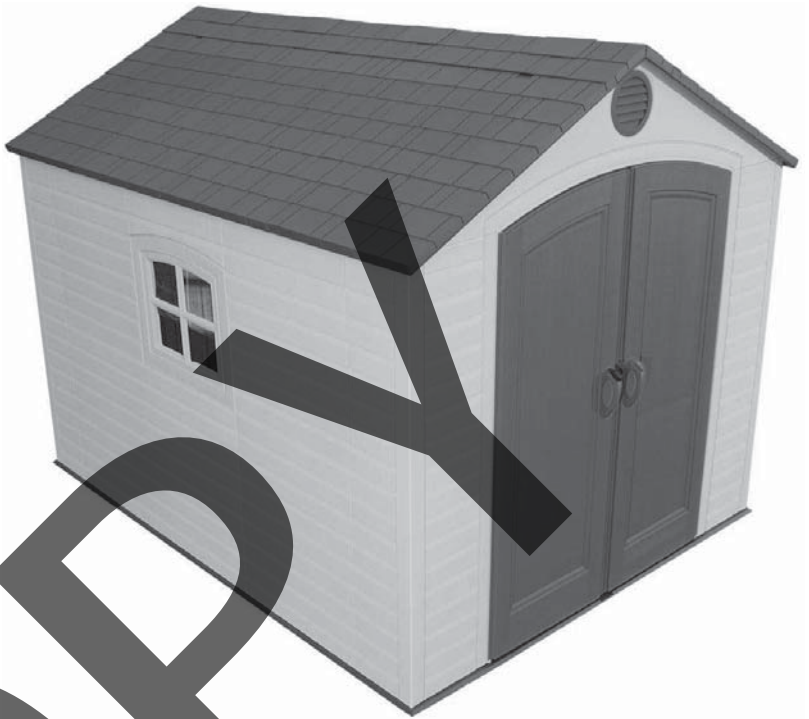

WATCH THE HOW-TO ON YOUTUBE



Scan the code, or visit go.lifetime.com/8x10storageassembly

YouTube® and the YouTube logo are trademarks of Google, LLC.

**FOR DOMESTIC USE ONLY!
IMPORTANT, RETAIN FOR FUTURE REFERENCE: READ CAREFULLY.**

TOOLS REQUIRED (NOT INCLUDED—UNLESS OTHERWISE INDICATED*)



TABLE OF CONTENTS

Icon Legend.....	4
Warnings & Notices.....	5
Platform Construction.....	6
Truss Assembly.....	11
Gable Assembly.....	16
Door Assembly.....	21
Floor Assembly.....	30
Wall Assembly.....	33
Parts Identifier.....	39
Shelving Installation.....	43
Door & Gable Installation.....	48
Roof Assembly.....	52
Window Pane Installation.....	63
Door Alignment.....	66
Shed Anchoring.....	68
Cleaning & Care.....	71
Registration.....	72
Warranty.....	73

QUESTIONS?

CONTACT LIFETIME CUSTOMER SERVICE:

Call: **1-800-225-3865**
 7:00 am–5:00 pm (M–F) MST
 and 9:00 am–1:00 pm (Sat) MST

Live Chat: www.lifetime.com/customerservice
 (click on "LIVE CHAT" tab)
For Customer Service in mainland Europe:
 E-mail: cs@lifetimeproducts.eu

MODEL# AND PRODUCT ID (you will need both when contacting us)
 Model Number: **60371**
 Product ID:



INSTRUCTIONS D'ASSEMBLAGE

For English, see page 1. Para el español, ver la página 3.

ABRI EXTÉRIEUR DE 2,4 x 3,1 m

MODÈLE n° 60371

AVANT L'ASSEMBLAGE :

- Assembler sur une plate-forme nivelée
- Nous recommandons, au moins, 3 adultes pour l'assemblage
- Examiner toutes les pièces et quincaillerie. Vérifier qu'elles sont incluses en utilisant l'Identificateur de pièces au milieu de ces instructions. Il est possible d'enlever l'Identificateur de pièces, en jaune, des instructions pour référence rapide

REGARDER LA VIDÉO SUR YOUTUBE



Scanner le code, ou visiter go.lifetime.com/8x10storageassembly

YouTube® et le logotype YouTube sont des marques déposées de Google, LLC.

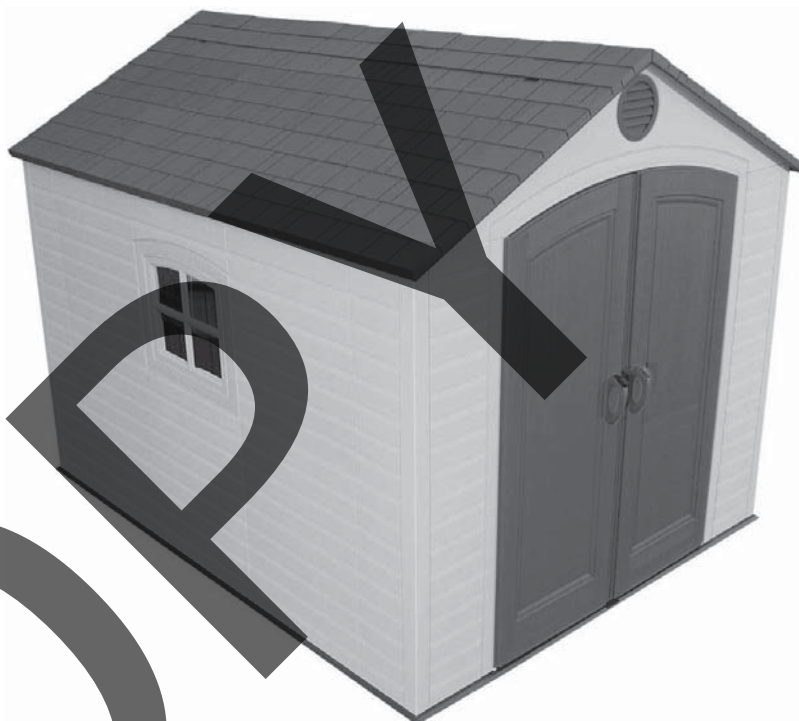

POUR L'USAGE DOMESTIQUE SEULEMENT !

IMPORTANT, CONSERVER POUR RÉFÉRENCE : LIRE AVEC PRUDENCE !

OUTILS REQUIS (NON INCLUS — SAUF INDICATION CONTRAIRE*)



SOMMAIRE

Légende des icônes.....	4
Avertissements et avis.....	5
Assemblage de la plate-forme.....	6
Assemblage des fermes.....	11
Assemblage des pignons.....	16
Assemblage des portes.....	21
Assemblage du plancher.....	30
Assemblage des murs.....	33
Identificateur de pièces.....	39
Installation du rayonnage.....	43
Installation des portes.....	48
Assemblage du toit.....	52
Installation du carreau.....	63
Alignement des portes.....	66
L'ancrage de l'abri.....	68
Nettoyage et entretien.....	71
Enregistrement.....	72
Garantie.....	74

QUESTIONS ?

CONTACTER LES SERVICES À LA CLIENTÈLE LIFETIME® :

Composer le **1-800-225-3865**
Du lundi au vendredi 7 h – 17 h (HNR)
et samedi 9 h – 13 h (HNR)

Entretien en direct: www.lifetime.com/customerservice
(cliquer sur la languette « LIVE CHAT »)
Pour les services à la clientèle du continent européen:
É-mail: cs@lifetimeproducts.eu

N° DE MODÈLE ET RÉFÉRENCE DU PRODUIT
(il faut avoir les deux en entrant en contact avec nous)
N° de modèle : **60371**
Référence du produit :



INSTRUCCIONES DE ENSAMBLAJE

For English, see page 1. Pour le français, voir la page 2.

CASETA EXTERIOR DE 2,4 x 3,0 m

MODELO n° 60371

ANTES DE ENSAMBLAR:

- Ensamblar sobre una plataforma nivelada
- Recomendamos, al menos, 3 adultos para el ensamblaje
- Inspeccionar todas las piezas y el herraje. Verificar que todos están incluidos usando el *Identificador de piezas* en el medio de estas instrucciones. Se puede quitar el *Identificador de piezas*, en amarillo, de las instrucciones para referencia rápida



MIRAR EL VIDEO EN YOUTUBE



Escanear el código, o visitar go.lifetime.com/8x10storageassembly

YouTube® y el logotipo YouTube son marcas registradas de Google, LLC.

¡SÓLO PARA USO DOMÉSTICO! ¡IMPORTANTE, GUARDAR PARA FUTURA REFERENCIA: LEER CUIDADOSAMENTE!

INSTRUMENTAL REQUERIDO (NO INCLUIDO, SALVO INDICACIÓN CONTRARIA*)



ÍNDICE

Leyenda de íconos.....	4
Advertencias y avisos.....	5
Ensamblaje de la plataforma.....	6
Ensamblaje de las cerchas.....	11
Ensamblaje de las fachadas.....	16
Ensamblaje de las puertas.....	21
Ensamblaje del piso.....	30
Ensamblaje de los muros.....	33
Identificador de piezas.....	39
Instalación de la estantería.....	43
Instalación de las puertas.....	48
Ensamblaje del tejado.....	52
Instalación de la hoja de ventana.....	63
Alineación de las puertas.....	66
Anclaje de la caseta.....	68
Limpieza y cuidado.....	71
Registro.....	72
Garantía.....	75

¿PREGUNTAS?

PONERSE EN CONTACTO CON LOS SERVICIOS DE CLIENTES LIFETIME®:

Marcar al 1-800-225-3865
De lunes hasta viernes 7:00 h–17:00 h (MST)
y sábado 9:00 h–13:00 h (MST)

Chat en vivo: www.lifetime.com/customerservice
(clicar en la lengüeta «LIVE CHAT»)
Para el servicio a clientes en el continente europeo:
Correo electrónico: cs@lifetimeproducts.eu

MODEL E ID DEL PRODUCTO (se necesitan los dos al contactarnos)
Número de modelo: 60371
ID del producto:



ICON LEGEND / LÉGENDE DES ICÔNES / SIGNIFICADO DE LOS ÍCONOS



- Indicates special heed should be taken when reading.
- Indique qu'une attention spéciale doit être portée à la lecture.
- Indica que uno debe prestar atención al leer.



- Indicates the parts/no parts required for a section.
- Indique les pièces à utiliser/qu'aucune pièce n'est requise pour une section.
- Indica las piezas que se usarán/que no necesitan en una sección.



- Indicates the hardware to be used for a section.
- Indique la quincaillerie à utiliser pour une section.
- Indica los artículos de ferretería que se usarán para una sección.



- Indicates no hardware required for a specific page or section.
- Indique qu'aucun matériel n'est requis pour une page précise.
- Indica que no se necesitan los artículos de ferretería para una página específica.



- Indicates the tools to be used for a section.
- Indique les outils à utiliser pour une section.
- Indica las herramientas que se utilizarán para una sección.



- Indicates to use/not use an electric drill for a specific step.
- Indique quand utiliser une/que ne pas utiliser de perceuse électrique pour une étape précise.
- Indica la utilización de/que no utilizar un taladro eléctrico para un paso específico.



- These nuts are centerlock nuts. They are designed to be tight; therefore, they will be harder to tighten. Tighten until flush with the metal or plastic.
- Ces écrous sont des écrous de blocage central. Ils sont conçus pour être serrés; de ce fait, ils seront plus difficiles à resserrer. Serrer jusqu'à ce qu'ils soient au ras du métal ou du plastique.
- Estas tuercas son tuercas de bloqueo central. Están diseñadas para estar apretadas; por lo tanto, serán más difíciles de apretar. Apriételas hasta que estén al ras del metal o plástico.



WARNINGS & NOTICES / AVERTISSEMENTS ET AVIS / ADVERTENCIAS Y AVISOS

English:

- **Failure to follow these warnings may result in serious injury or property damage and will void warranty.**
- To ensure safety, do not attempt to assemble this product without following the instructions carefully.
- Consult all local building codes to verify if the shed requires a building permit.
- Verify the foundation is completely level before assembling the shed.
- Be aware that plastic pieces can be damaged by overtightening the screws. To avoid damage, we strongly recommend the use of a drill with a low torque setting. A #2 Phillips screwdriver may also be used.
- Three capable adults are required for assembly.
- All who participate in the assembly process should wear safety glasses throughout the assembly.
- If using a ladder during assembly, use extreme caution.
-  In heavy snowfall areas, we recommend removing snow from the roof. Remove the snow from the roof when the depth of snow equals the length of your hand.
- Do not use or store hot objects near the product.
- Proper and complete assembly are essential to reduce the risk of accident or injury.
- When drilling through metal, beware of burrs, shavings and other sharp edges.
- During and after assembly, do not slide or lift the shed by pushing up on the roof. Move the shed by pushing on the corner panels only.
- We strongly recommend anchoring your shed when it is finished. The last section, *Shed Anchoring*, in this manual shows the hardware you will need to complete the anchoring. You can find the hardware at your local hardware store.
- **Most injuries are caused by misuse and/or not following instructions. Use caution when using this product.**

Français :

- **Ne pas suivre ces avertissements peut entraîner des blessures graves ou des dommages à la propriété et annulera la garantie.**
- Afin d'assurer la sécurité, ne pas tenter d'assembler ce produit sans suivre attentivement les instructions.
- Consulter tous les codes du bâtiment afin de vérifier si l'abri nécessite un permis de construire.
- Vérifier que la fondation est complètement à niveau avant l'assemblage de l'abri.
- Ne pas oublier que les pièces de plastique peuvent être endommagées en serrant trop les vis. Afin d'éviter les dommages, nous recommandons fortement l'utilisation d'une perceuse à faible couple. Un tournevis cruciforme n° 2 peut aussi être utilisé.
- Trois adultes en bonne condition physique sont nécessaires pour l'assemblage.
- Tout ceux qui participent au processus de l'assemblage doivent porter des lunettes de sécurité tout au long de l'assemblage.
- Si une échelle est utilisée pour l'assemblage, il faut être extrêmement prudent.
-  Dans les zones de fortes tombées de neige, il est recommandé de dégager le toit. Enlever la neige du toit quand la profondeur est égale à la longueur de la main.
- Ne pas utiliser ou entreposer des objets très chauds près de ce produit.
- Un bon assemblage complet est nécessaire pour réduire le risque d'accident ou de blessure.
- En perçant le métal, faire attention aux bavures, copeaux et autres bords aiguisés.
- Pendant et après l'assemblage, ne pas faire glisser ou soulever l'abri en poussant le toit vers le haut. Déplacer l'abri en poussant les panneaux muraux angulaires seulement.
- Il est fortement recommandé d'ancrer l'abri lorsque l'assemblage est terminé. La dernière section, *Ancrage de l'abri*, de ce manuel indique les matériaux nécessaires pour l'ancrage. Les matériaux se trouvent dans la quincaillerie locale.
- **La majorité des blessures sont causées par une mauvaise utilisation et/ou le non suivi des instructions. Être prudent en utilisant ce produit.**

Español:

- **No seguir estas advertencias puede resultar en lesiones graves o daños a la propiedad y anulará la garantía.**
- A fin de garantizar la seguridad, no intentar ensamblar este producto sin seguir cuidadosamente las instrucciones.
- Consultar todos los códigos de construcción locales para verificar si la caseta requiere un permiso de construcción.
- Verificar que el concreto esté nivelado completamente antes de ensamblar la caseta.
- Tener en cuenta que las piezas de plástico pueden dañarse si los tornillos se aprietan de más. A fin de evitar daños, lo exhortamos a que use un taladro con función de torque bajo. También puede usarse un desatornillador Phillips no. 2.
- Se necesitan tres adultos para el ensamble.
- Todos los que participen en el proceso de ensamble debe usar anteojos de seguridad durante todo el ensamble.
- Si se usa una escalera durante el ensamblado, es preciso tener cuidado.
-  En áreas de nevadas fuertes, recomendamos retirar la nieve del techo. Quitar la nieve del tejado cuando la profundidad de ella es igual a la longitud de la mano.
- No usar ni guardar objetos calientes cerca del producto.
- El ensamblaje correcto y completo son esenciales para reducir el riesgo de accidente o lesión.
- Al perforar metal, tenga cuidado las rebabas, virutas y otros bordes afilados.
- Durante y después del ensamblaje, no deslizar ni levantar la caseta para empujar en el tejado. Mover la caseta para empujar los paneles murales angulares solamente.
- Lo exhortamos a anclar la caseta al terminar el ensamble. La última sección, *Anclaje de la caseta*, en este manual muestra el herraje necesaria para terminar el anclaje. Se encuentra el herraje en la ferretería local.
- **La mayoría de las lesiones suceden a causa del mal uso y/o por no seguir las instrucciones. Tener precaución al usar este producto.**

1

PLATFORM CONSTRUCTION / CONSTRUCTION DE LA PLATE-FORME / CONSTRUCCIÓN DE LA PLATAFORMA



• You must provide a platform on which to assemble your shed. Proper building permit documentation may be required in your neighborhood. Consult all local building codes prior to assembling the shed. Before beginning assembly, you must pour or construct a platform. There are two types:

- **Concrete**
- **Wood Frame**

Select the type, but know the surface must be leveled and flat before installation. If the surface is not properly leveled and flat, the shed will not assemble correctly. Proper surface leveling will save you time in the long run, so please do not ignore this step.

We recommend a Concrete platform. It will be the most durable and long-lasting choice. The platform you choose must be built above ground in order to avoid water pooling inside the shed. All lumber must be rated for outdoor use!



• Il faut construire une plate-forme sur laquelle vous devez assembler votre abri. Il est possible que votre quartier exige une documentation visant les permis de construire. Consultez tous les codes du bâtiment locaux, ainsi que les décrets des villes et comtés, pour vérifier que la construction de l'abri extérieur n'exige pas un permis de construire. Avant de commencer l'assemblage, il faut couler ou construire une plate-forme. Il y a deux styles :

- **Béton**
- **Cadre à bois**

Sélectionnez le style, mais sachez que la surface d'installation doit être de niveau et plate. Si la surface n'est pas correctement de niveau et plate, l'assemblage de l'abri ne se fera pas correctement. Vous gagnerez du temps sur le long terme grâce à une surface bien de niveau, ne négligez donc pas cette étape. **Nous recommandons une plate-forme en Béton. Ce choix sera le plus durable.**

La plate-forme que vous choisissez doit être construite au-dessus du sol afin d'éviter l'accumulation d'eau à l'intérieur de l'abri. Tous le bois d'oeuvre doit être approuvé pour l'usage à l'extérieur !



• Es preciso construir una plataforma sobre la cual usted debe ensamblar su caseta. Puede suceder que en su vecindario se requiera la documentación apropiada de un permiso de construcción. Consulte todos los códigos locales de construcción y los reglamentos de la ciudad y el municipio para asegurarse de que la construcción de la caseta no requiere un permiso de construcción. Antes de comenzar el ensamble, es necesario verter o construir una plataforma. Hay dos clases:

- **Concreto**
- **Armazón de madera**

Seleccione la clase, mas sepa que la superficie debe estar nivelada y plana antes de comenzar el ensamble. Si la superficie no está nivelada y plana de manera adecuada, la caseta no podrá ensamblarse correctamente. La nivelación de la superficie le ahorrará tiempo de trabajo, por lo tanto, le pedimos que no ignore este paso. **Recomendamos una plataforma hecho de concreto. Será la elección más perdurable. La plataforma debe ser construida arriba del suelo para evitar el aflujo de agua dentro de la caseta. ¡Toda la madera debe estar clasificada para el uso externo!**

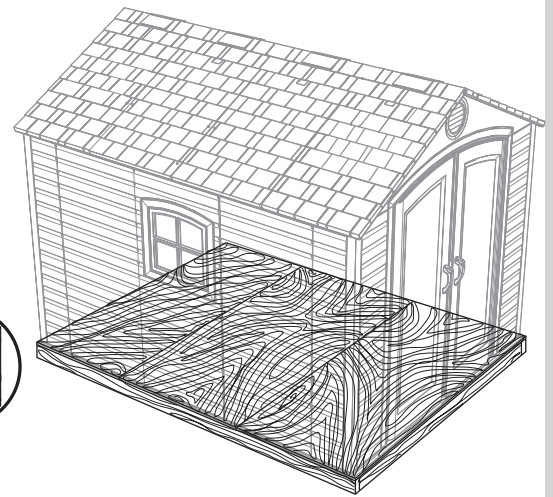
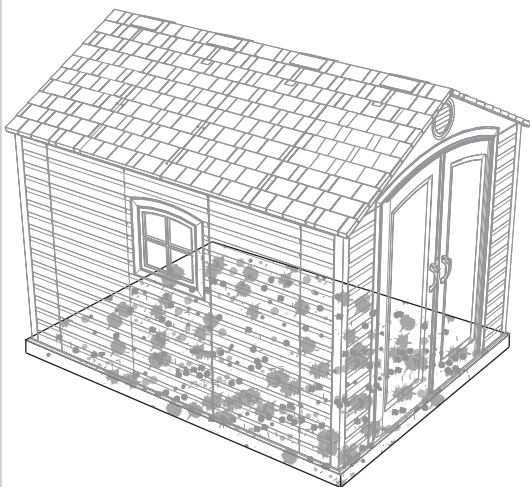

► SECTION 1 (CONTINUED) / SECTION 1 (SUITE) / SECCIÓN 1 (CONTINUACIÓN)

CONCRETE REQUIRED / BÉTON REQUIS / CONCRETO REQUERIDO



1 yd³ (0,77 m³)

1.1

CONCRETE PLATFORM / PLATE-FORME EN BÉTON / PLATAFORMA DE CONCRETO

- The concrete should be approximately 4" (10,2 cm) thick. The actual dimensions of the shed, at its widest and longest points, are 96" x 120" (2,44 m x 3,05 m). Ensure you select a site that will accommodate these measurements. **The floor dimensions are a bit smaller than those of the roof; therefore, you will need to build a level surface of 93 1/2" x 118 1/4" (2,38 m x 3,00 m).**
- Le béton doit être un épaisseur de 10,2 cm (4"). Les dimensions réelles de votre abri, aux points les plus large et long, sont 2,44 m x 3,05 m (96" x 120"). Veiller à sélectionner un site qui accommodera ces dimensions. **Les dimensions du plancher de l'abri sont plus petites que le toit; ensuite, il faut créer une surface horizontale de 2,38 m x 3,00 m (93 1/2" x 118 1/4").**
- El concreto debe tener, por lo menos, 10,2 cm (4") de espesor. Las dimensiones reales de la caseta, a sus puntos más ancho y largo, son 2,44 m x 3,05 m (96" x 120"). Asegurarse de seleccionar un sitio que acomodará estas medidas. **Las dimensiones del piso de la caseta son más pequeñas que el tejado; entonces, se necesita crear una superficie nivelada de 2,38 m x 3,00 m (93 1/2" x 118 1/4").**

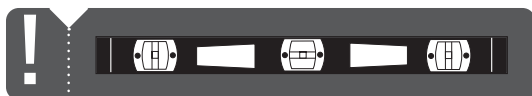
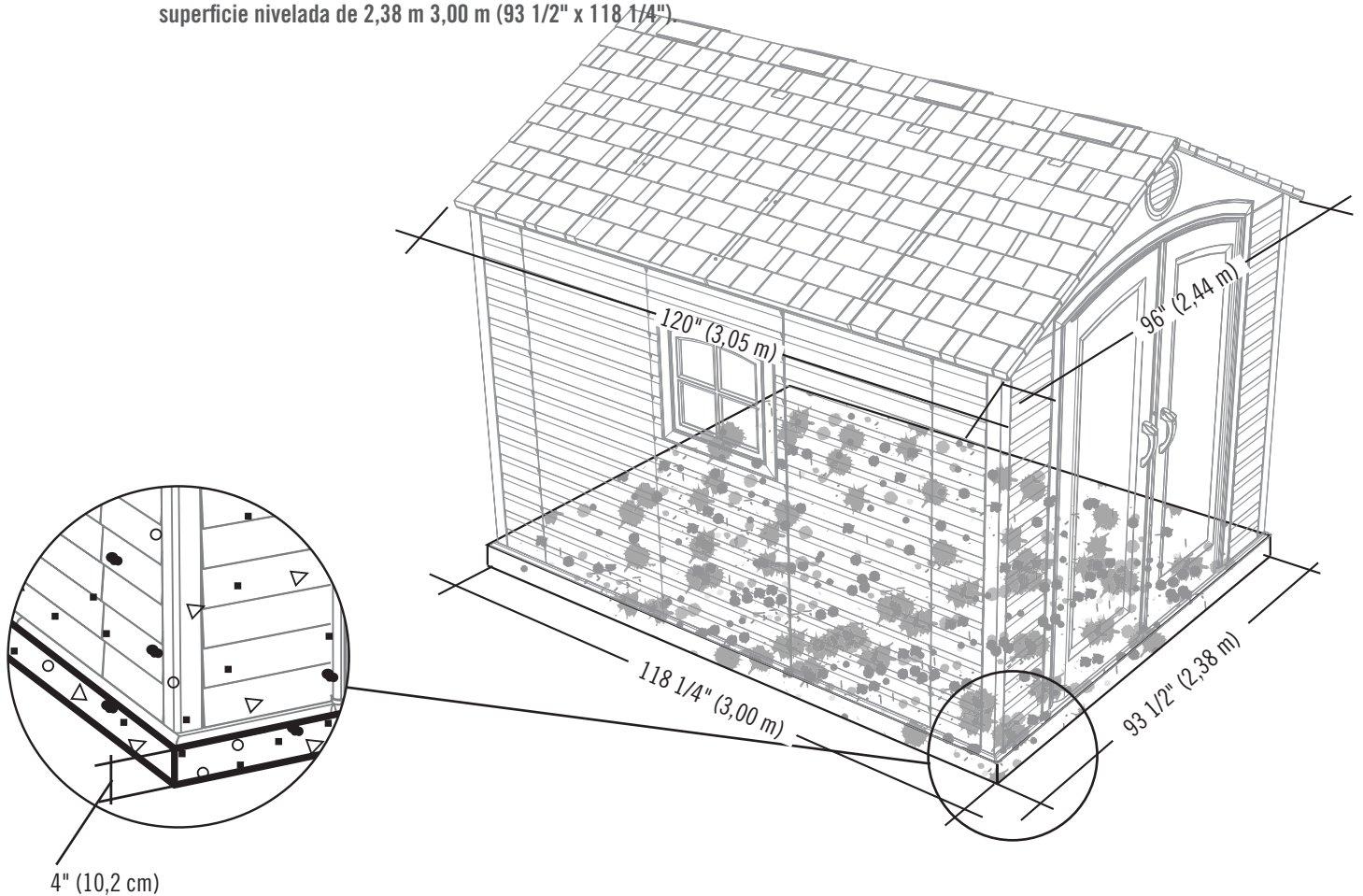

► SECTION 1 (CONTINUED) / SECTION 1 (SUITE) / SECCIÓN 1 (CONTINUACIÓN)

WOOD REQUIRED / BOIS REQUIS / MADERA REQUERIDA



1.2

WOOD PLATFORM / PLATE-FORME EN BOIS / PLATAFORMA DE MADERA

- **All lumber must be rated for outdoor use!** The actual dimensions of the shed, at its widest and longest points, are 96" x 120" (2,44 m x 3,05 m). Ensure you select a site that will accommodate these measurements. **The floor dimensions are a bit smaller than those of the roof; therefore, you will need to build a level surface of 93 1/2" x 118 1/4" (2,38 m 3,00 m).**
- **Tous le bois d'oeuvre doit être approuvé pour l'usage à l'extérieur !** Les dimensions réelles de votre abri, aux points les plus large et long, sont 2,44 m x 3,05 m (96" x 120"). Veiller à sélectionner un site qui accommodera ces dimensions. **Les dimensions du plancher de l'abri sont plus petites que le toit; ensuite, il faut créer une surface horizontale de 2,38 m x 3,00 m (93 1/2" x 118 1/4").**
- **¡Toda la madera debe estar clasificada para el uso externo!** Las dimensiones reales de la caseta, a sus puntos más ancho y largo, son 2,44 m x 3,05 m (96" x 120"). Asegurarse de seleccionar un sitio que acomodará estas medidas. **Las dimensiones del piso de la caseta son más pequeñas que el tejado; entonces, se necesita crear una superficie nivelada de 2,38 m 3,00 m (93 1/2" x 118 1/4").**

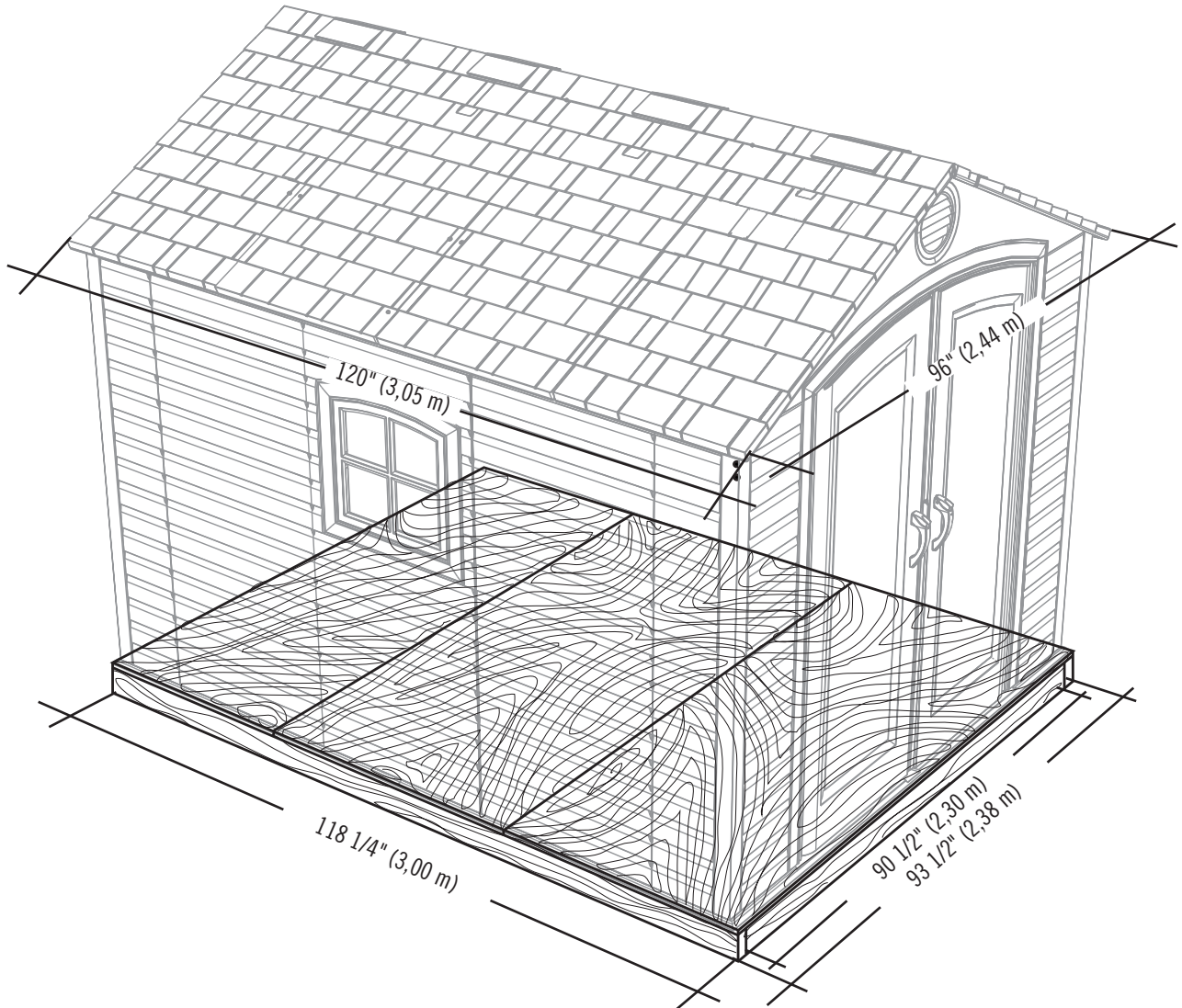

► SECTION 1 (CONTINUED) / SECTION 1 (SUITE) / SECCIÓN 1 (CONTINUACIÓN)

TOOLS, PARTS, AND HARDWARE REQUIRED / OUTILS, PIÈCES, ET QUINCAILLERIE REQUIS / INSTRUMENTAL, PIEZAS, Y HERRAJE REQUERIDOS

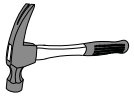

2" x 4" x 118 1/4" (5,1 cm x 10,2 cm x 3,00 m) (x2)



2" x 4" x 90 1/2" (5,1 cm x 10,2 cm x 2,30 m) (x9)

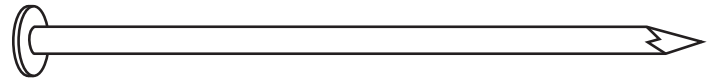

16d 3 1/2" (16d x 8,89 cm) (x36)

1.2.1

WOOD PLATFORM / PLATE-FORME EN BOIS / PLATAFORMA DE MADERA

- Ensure all lumber is treated and approved for outdoor use. Build frame to 93 1/2" x 118 1/4" (2,38 m x 3,00 m) (**outside dimensions**).
- Vérifier que le bois d'œuvre a été traité et approuvé pour l'utilisation à l'extérieur. Construire un cadre de 2,38 m x 3,00 m (93 1/2" x 118 1/4") (**dimensions extérieures**).
- Asegurarse de usar madera tratada y aprobada para el uso externo. Construir el armazón a 2,38 m x 3,00 m (93 1/2" x 118 1/4") (**dimensiones exteriores**).

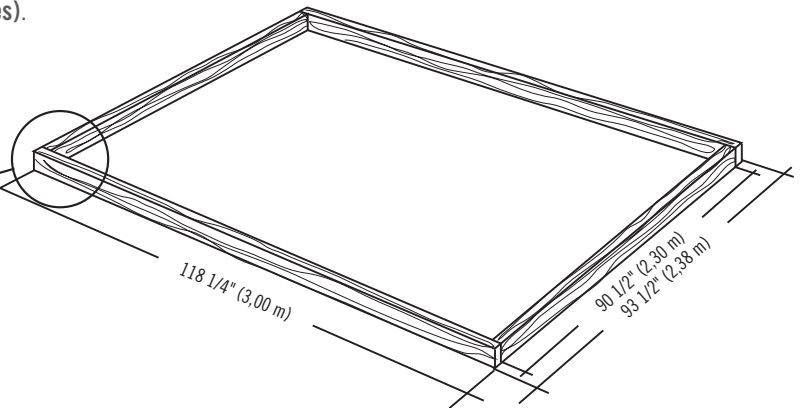
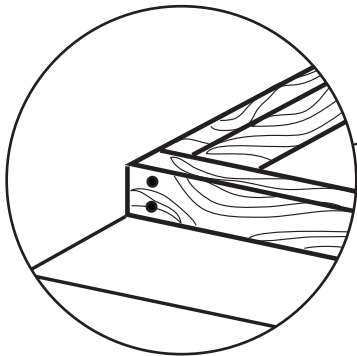

1.2.2

- To ensure studs are in the correct location for nailing plywood in the next step, start measuring from the corner 16" (40,1 cm), and then measure from center to center.
- Pour être sûr d'avoir assez de montant pour clouer le contreplaqué dans la prochaine étape, commencer à mesurer à partir de cette montant 40,1 cm (16") vers le centre du deuxième montant. Ensuite, mesurer de centre à centre pour les montants restants.
- Para asegurarse que los montantes están en las ubicaciones correctas para el contrachapado en el paso siguiente, comenzar a medir desde el borde del montante hasta el centro del próximo montante 40,1 cm (16"). Luego, tomar la medida de centro a centro en los montantes restantes.

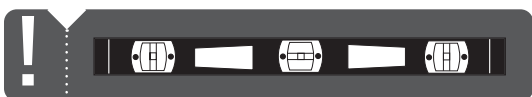
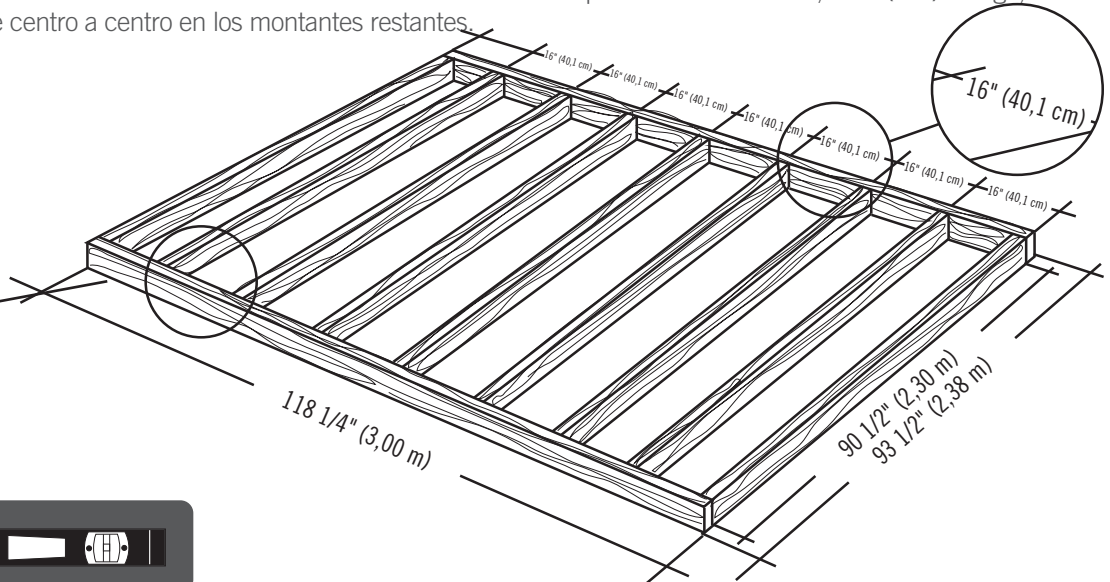
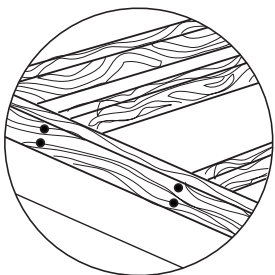

► SECTION 1 (CONTINUED) / SECTION 1 (SUITE) / SECCIÓN 1 (CONTINUACIÓN)

TOOLS, PARTS, AND HARDWARE REQUIRED / OUTILS, PIÈCES, ET QUINCAILLERIE REQUIS / INSTRUMENTAL, PIEZAS, Y HERRAJE REQUERIDOS

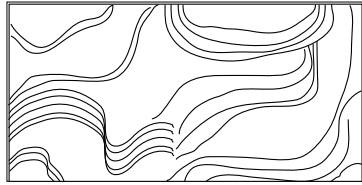
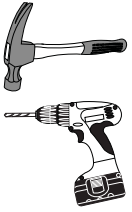

48" x 93 1/2" x 3/4"
(1,22 m x 2,38 m x 19,1 mm) (x2)



22 1/4" x 93 1/2" x 3/4"
(57 cm x 2,38 m x 19,1 mm) (x1)

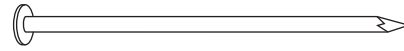

8d 2" (8d 5,08 cm) (x66)

1.2.3

- Square the frame, measuring from corner to corner. **Measurement A & B should be about the same length.**
- Carrer le cadre en mesurant d'angle à angle. **La mesure "A" et "B" doivent être à peu près la même longueur.**
- Cuadrar el armazón mediendo de esquina a esquina. **La medida "A" y "B" deben ser aproximadamente el mismo largo.**

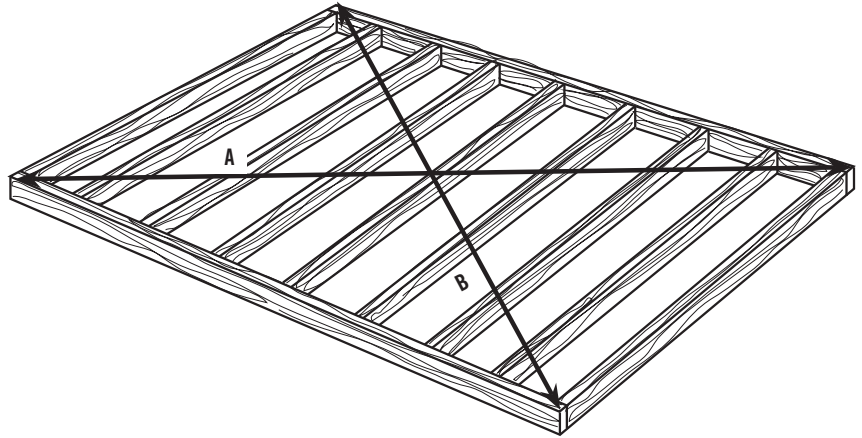

! A = B

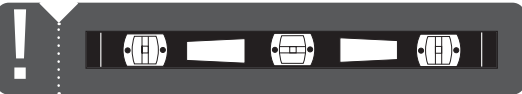

1.2.4

- Using nails, fasten the plywood to the frame. Then, drill 5/16" holes for drainage.
- En utilisant des clous, attacher bien le contreplaqué au cadre. Ensuite, percer des trous de 8 mm pour le drainage.
- Usando unos clavos, sujetar el contrachapado al armazón. Entonces, taladrar agujeros de 8 mm para el drenaje.

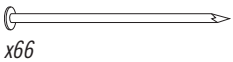

x66

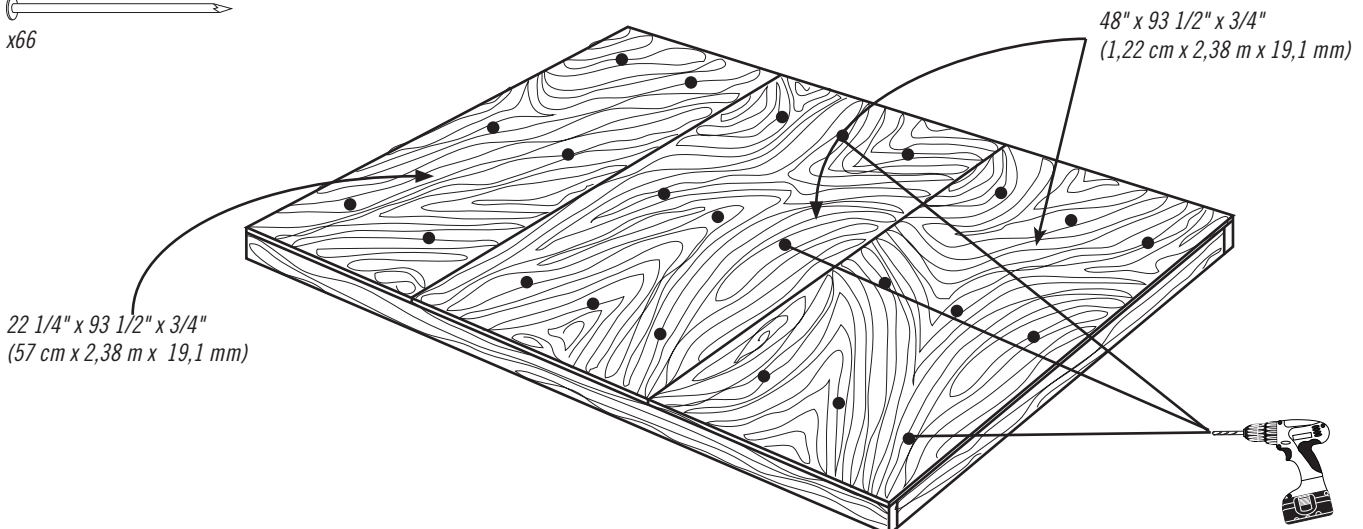

22 1/4" x 93 1/2" x 3/4"
(57 cm x 2,38 m x 19,1 mm)

48" x 93 1/2" x 3/4"
(1,22 cm x 2,38 m x 19,1 mm)

Drainage Holes
Trous de drainage
Agujeros para canalización

x24!

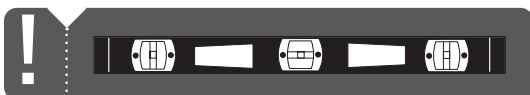

2

TRUSS ASSEMBLY / ASSEMBLAGE DES FERMES / ENSAMBLE DE LAS CERCHAS



HARDWARE REQUIRED / QUINCAILLERIE REQUISE / HERRAJE REQUERIDO

Hardware Bag / Sac de quincaillerie / Bolsa de herraje

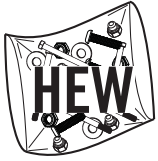

DTK (x12)



ADJ (x6)

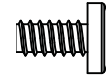

ADY (x12)



ADK (x24)

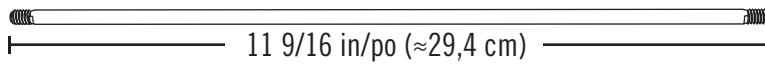

11 9/16 in/po (≈29,4 cm)

ADH (x3)

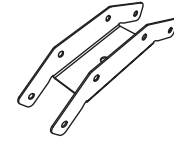

AIP (x3)



PARTS REQUIRED / PIÈCES REQUISES / PIEZAS REQUERIDAS

Metal Parts / Pièces en métal / Piezas de metal



50 9/16 in/po (≈1,28 m)

DSR (x6)

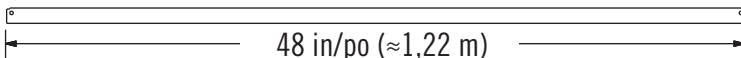

48 in/po (≈1,22 m)

AFG (x3)

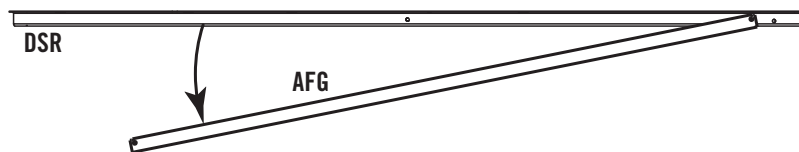
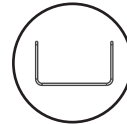

- Sometimes during shipping, the Truss Brace (AFG) slides over the back of the Truss Gutter Channel (DSR). The two pieces are the same color. If you think you're missing a Truss Brace, check to see if it is stuck to the back of the Truss Gutter Channel, and separate the two.
- Durant le transport, parfois le support de ferme (AFG) glisse par-dessus l'arrière du canal de ferme (DSR). Les deux pièces sont du même colour. Si vous pensez que vous n'avez pas de support de ferme, vérifiez s'il y a un support de ferme adhérent à l'arrière du canal de ferme, et séparez les deux.
- Durante el transporte, a veces el soporte de cercha (AFG) deslice sobre el dorso del canalón de cercha (DSR). Las dos piezas son de la misma color. Si piensas que le falta un soporte de cercha, verifique si haya un soporte pegado al dorso del canalón de cercha, y separe las dos.



TOOLS REQUIRED (NOT INCLUDED—UNLESS INDICATED OTHERWISE*) / OUTILS REQUIS (NON INCLUS — SAUF INDICATION CONTRAIRE*) / INSTRUMENTAL REQUERIDO (NO INCLUIDO, SALVO INDICACIÓN CONTRARIA*)



7/16 in/po (≈11 mm)
(x2)



3/8 in/po (≈10 mm)

► SECTION 2 (CONTINUED) / SECTION 2 (SUITE) / SECCIÓN 2 (CONTINUACIÓN)

TOOLS AND HARDWARE REQUIRED / OUTILS ET QUINCAILLERIE REQUIS / INSTRUMENTAL Y HERRAJE REQUERIDOS

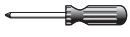

3/8 in/po
(≈10 mm)

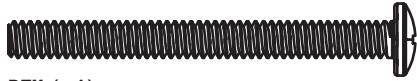

DTK (x4)



ADK (x4)

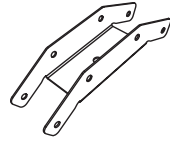

AIP (x1)



- In case of any trouble with this section, scan the QR code below to view a video on its assembly.
- En cas de problème avec cette section, scanner le QR code en dessous pour voir une vidéo de l'assemblage.
- En caso de problemas con esta sección, escanear el código QR debajo para ver un video del ensamblaje.



<http://go.Lifetime.com/8x10storageshed-section2>

2.1

- Slide a **connector (AIP)** onto the ends of two **truss gutter channels (DSR)** as shown.
- Faire glisser un **raccord (AIP)** sur les extrémités des **canaux de gouttière (DSR)** comme illustré.
- Deslizar un **connector (AIP)** en los extremos de los **canalones de cercha (DRS)** como se muestra.

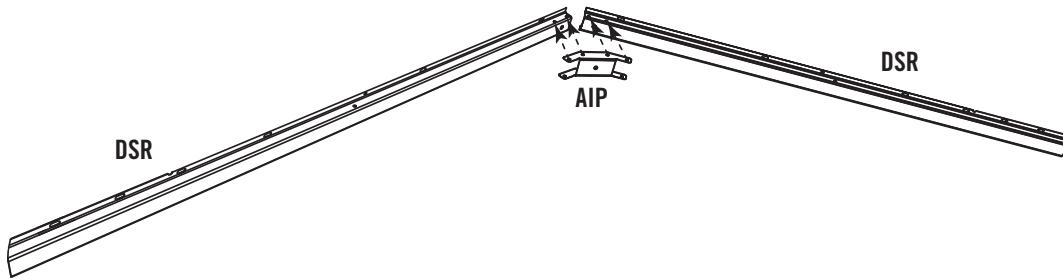

2.2

- Attach the **connector** using the hardware indicated. **Do not overtighten the cap nuts.**
- Attacher le **raccord (AIP)** à l'aide de la quincaillerie indiquée. **Ne pas serrer excessivement les écrous borgnes.**
- Sujetar el **connector (AIP)** usando el herraje indicado. **No apretar demasiado las tuercas ciegas.**

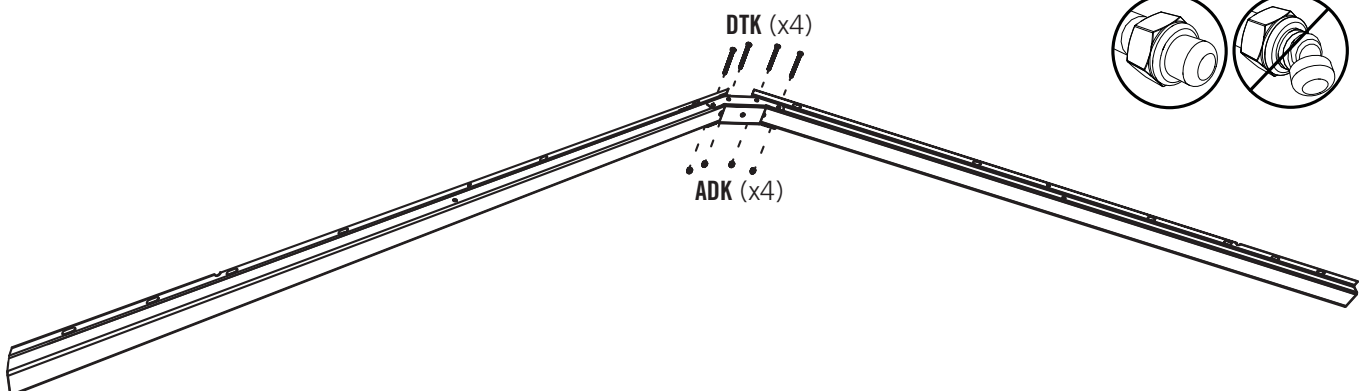

► SECTION 2 (CONTINUED) / SECTION 2 (SUITE) / SECCIÓN 2 (CONTINUACIÓN)

TOOLS AND HARDWARE REQUIRED / OUTILS ET QUINCAILLERIE REQUIS / INSTRUMENTAL Y HERRAJE REQUERIDOS



3/8 in/po
(≈10 mm)

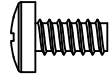

ADY (x4)



ADK (x4)

2.3

- Slide a **large truss brace (AFG)** onto the truss gutter channels as shown, and align the holes.
- Faire glisser un **support de ferme (AFG)** sur les canaux de gouttière comme illustré, et aligner les trous.
- Deslizar un **soporte de cercha (AFG)** sobre los canalones de la cercha como se muestra, y alinear los agujeros.

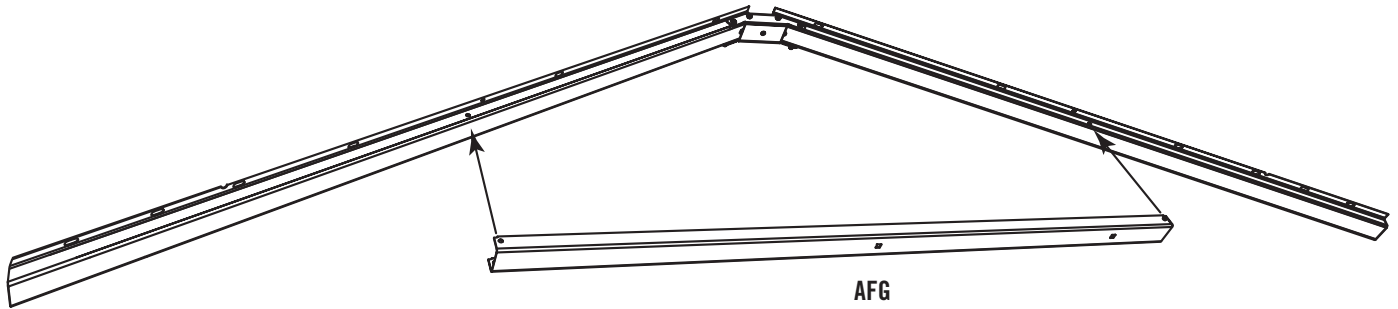

2.4

- Attach the large truss brace using the hardware included. **Do not overtighten the cap nuts.**
- Attacher le support de ferme à l'aide de la quincaillerie incluse. **Ne pas serrer excessivement les écrous borgnes.**
- Sujetar el soporte de cercha usando el herraje incluido. **No apretar demasiado las tuercas ciegas.**

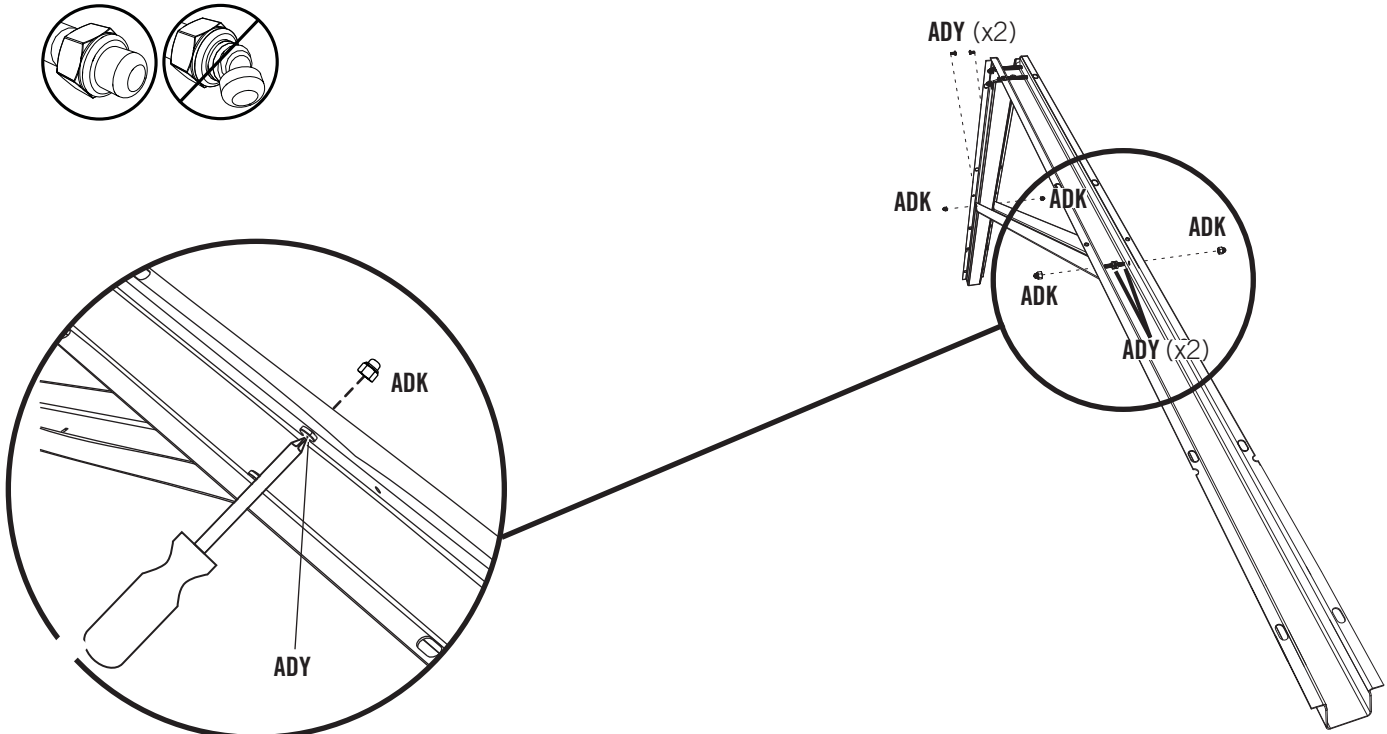
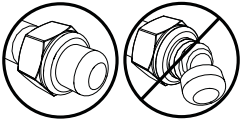

► SECTION 2 (CONTINUED) / SECTION 2 (SUITE) / SECCIÓN 2 (CONTINUACIÓN)

TOOLS AND HARDWARE REQUIRED / OUTILS ET QUINCAILLERIE REQUIS / INSTRUMENTAL Y HERRAJE REQUERIDOS

7/16 in/po (x2)
(≈11 mm) (x2)

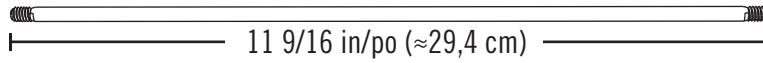

ADH (x1)



ADJ (x2)

2.5

- Slide a **truss rod (ADH)** through the holes in the truss brace and connector. Secure with two **cap nuts (ADJ)**. **Do not overtighten the nuts.**
- Faire glisser une **tige (ADH)** à travers les trous dans le support et le raccord. L'attacher bien à l'aide de deux **écrous borgnes (ADJ)**. **Ne pas serrer excessivement les écrous.**
- Deslizar una **varilla (ADH)** a través de los agujeros en el soporte y el conector. Sujetarla con dos **tuercas ciegas (ADJ)**. **No apretar demasiado las tuercas.**

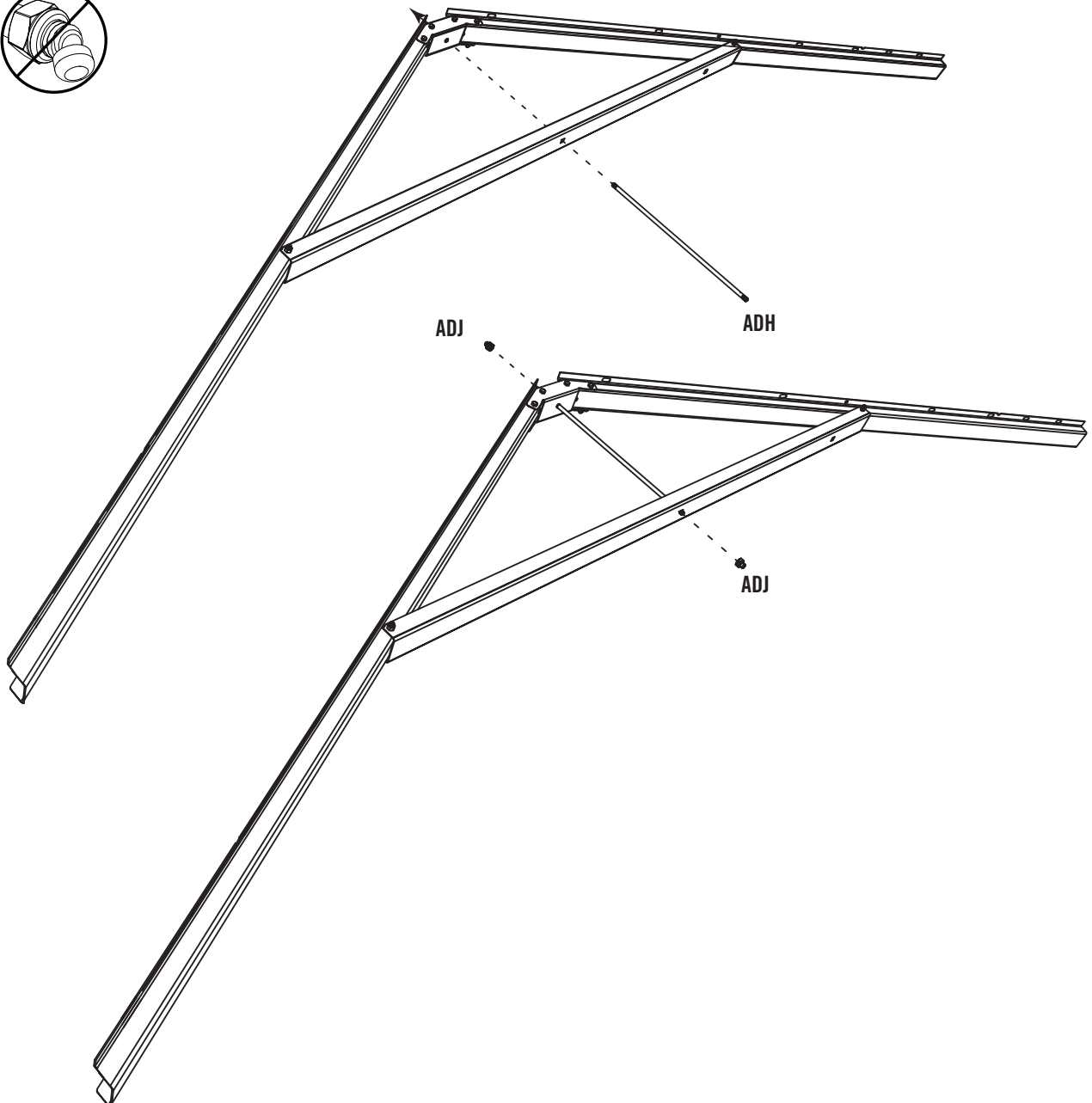
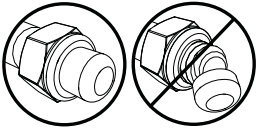

► SECTION 2 (CONTINUED) / SECTION 2 (SUITE) / SECCIÓN 2 (CONTINUACIÓN)

TOOLS AND HARDWARE REQUIRED / OUTILS ET QUINCAILLERIE REQUIS / INSTRUMENTAL Y HERRAJE REQUERIDOS



3/8 in/po
(≈10 mm)



7/16 in/po (x2)
(≈11 mm) (x2)



DTK (x8)



ADY (x8)



ADK (x16)



ADJ (x4)

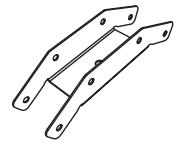

AIP (x2)

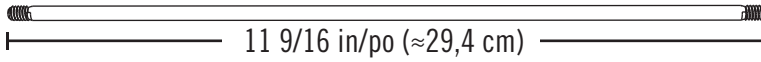

11 9/16 in/po (≈29,4 cm)

ADH (x2)

2.6

- Repeat steps 2.1–2.5 two times.
- Répéter les étapes 2.1 – 2.5 deux fois.
- Repetir los pasos 2.1–2.5 dos veces.



3

GABLE ASSEMBLY / ASSEMBLAGE DES PIGNONS / ENSAMBLAJE DE LAS FACHADAS



HARDWARE REQUIRED / QUINCAILLERIE REQUISE / HERRAJE REQUERIDO

Hardware Bag / Sac de quincaillerie / Bolsa de herraje

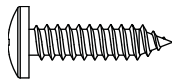

ADW (x10)

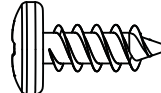

ADZ (x6)



ADK (x2)

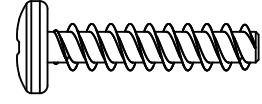

ADV (x6)



AHS (x2)



EYR (x2)



CXK (x2)

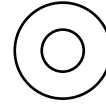

AEE (x14)

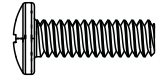

EYQ (x2)

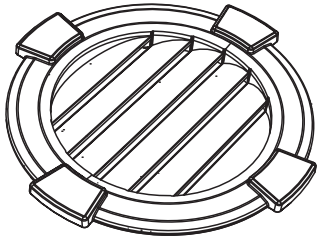

ENH (x2)

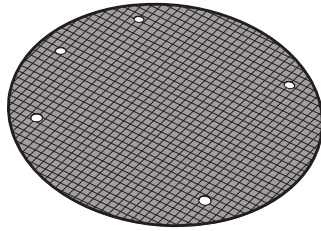

AIQ (x2)



PARTS REQUIRED / PIÈCES REQUISES / PIEZAS REQUERIDAS

Metal Part / Pièce en métal / Pieza de metal



EYS (x1)

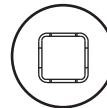

Plastic Parts / Pièces en plastique / Piezas de plástico

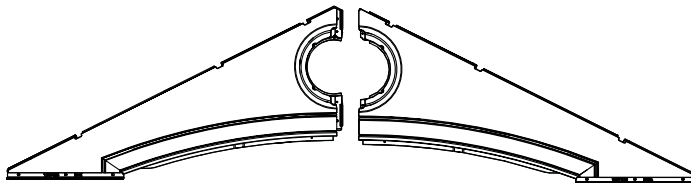

EVZ (x1)

EWA (x1)

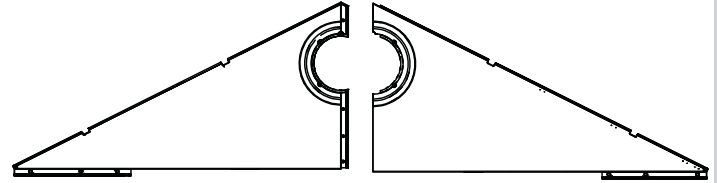

AGI (x1)

AGH (x1)



TOOLS REQUIRED (NOT INCLUDED—UNLESS INDICATED OTHERWISE*) / OUTILS REQUIS (NON INCLUS — SAUF INDICATION CONTRAIRE*) / INSTRUMENTAL REQUERIDO (NO INCLUIDO, SALVO INDICACIÓN CONTRARIA*)



3/8 in/po (≈10 mm)

► SECTION 3 (CONTINUED) / SECTION 3 (SUITE) / SECCIÓN 3 (CONTINUACIÓN)

TOOLS AND HARDWARE REQUIRED / OUTILS ET QUINCAILLERIE REQUIS / INSTRUMENTAL Y HERRAJE REQUERIDOS

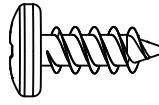

ADZ (x4)



- In case of any trouble with this section, scan the QR code below to view a video on its assembly.
- En cas de problème avec cette section, scanner le QR code en dessous pour voir une vidéo de l'assemblage.
- En caso de problemas con esta sección, escanear el código QR debajo para ver un video del ensamblaje.



<http://go.Lifetime.com/8x10storageshed-section3>

3.1

- Align the holes in the **left (AGH)** and **right (AGI)** rear gable halves.
- Aligner les trous dans les **pignons gauche (AGH)** et **droite (AGI)**.
- Alinear los agujeros en las **fachadas traseras izquierda (AGH)** y **derecha (AGI)**.

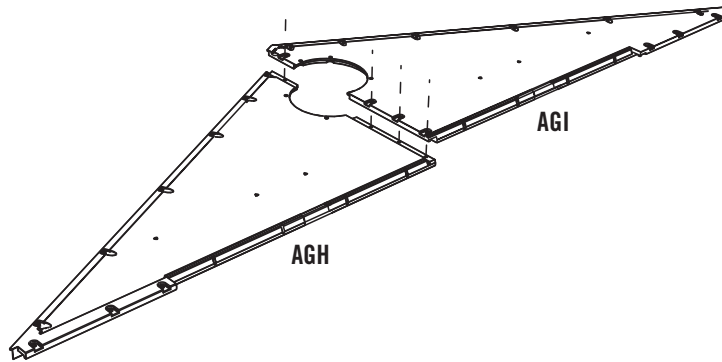

3.2

- Secure the two gable halves with four (4) **screws (ADZ)**.
- Attacher l'un à l'autre à l'aide de quatre (4) **vis (ADZ)**.
- Sujetar el uno al otro usando cuatro (4) **tornillos (ADZ)**.

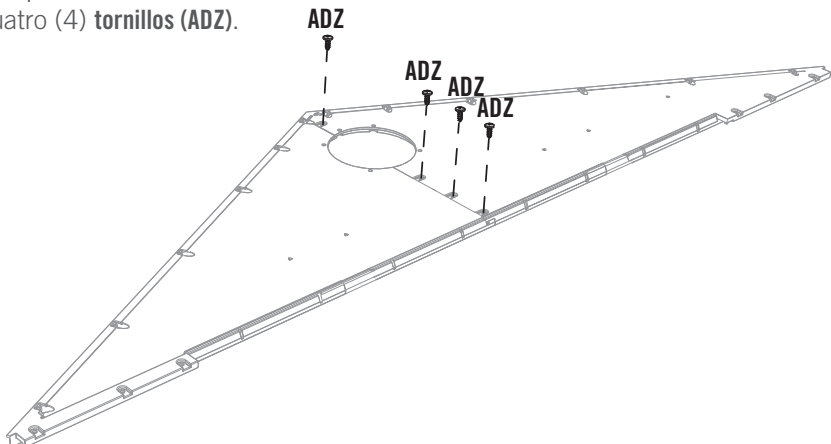

► SECTION 3 (CONTINUED) / SECTION 3 (SUITE) / SECCIÓN 3 (CONTINUACIÓN)

TOOLS AND HARDWARE REQUIRED / OUTILS ET QUINCAILLERIE REQUIS / INSTRUMENTAL Y HERRAJE REQUERIDOS



3/8 in/po
(≈10 mm)

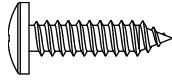

ADW (x5)

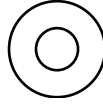

AEE (x5)

3.3

- Place the **screen (AIQ)** over the **vent (ENH)**, and align the five holes in the vent with those in the gable.
- Mettre la **moustiquaire (AIQ)** sur l'**évent (ENH)**, et aligner les cinq trous dans l'évent avec ceux du pignon.
- Colocar el **mosquitero (AIQ)** sobre la **rejilla de ventilación (ENH)**, y alinear los agujeros en la rejilla con los de la fachada.

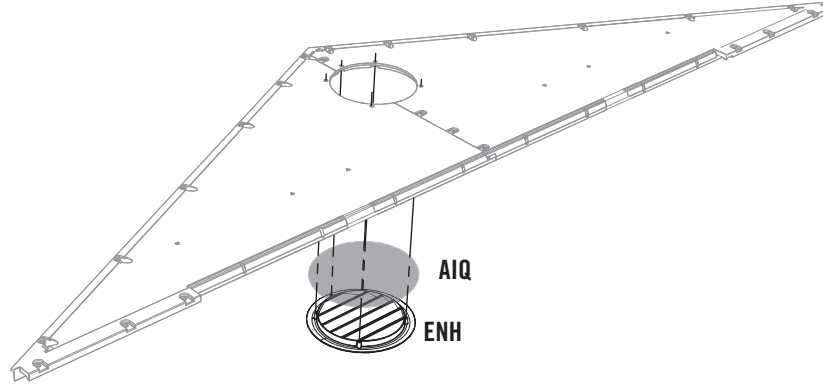

3.4

- Secure with the hardware included.
- Attacher-les en utilisant la quincaillerie incluse.
- Sujetar los unos a los otros usando el herraje incluido.

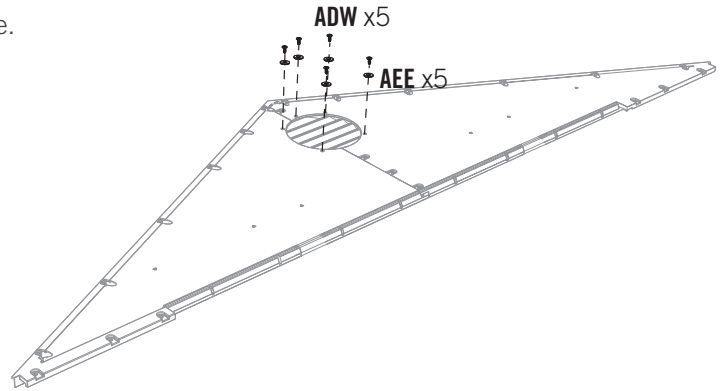

3.5

- Align the holes in the **left (EVZ)** and **right (EWA)** entry gable halves.
- Aligner les trous dans les **demis pignons d'entrée gauche (EVZ)** et **droit (EWA)**.
- Alinear los agujeros en las **mitades de la fachada trasera izquierda (EVZ)** y **derecha (EWA)**.

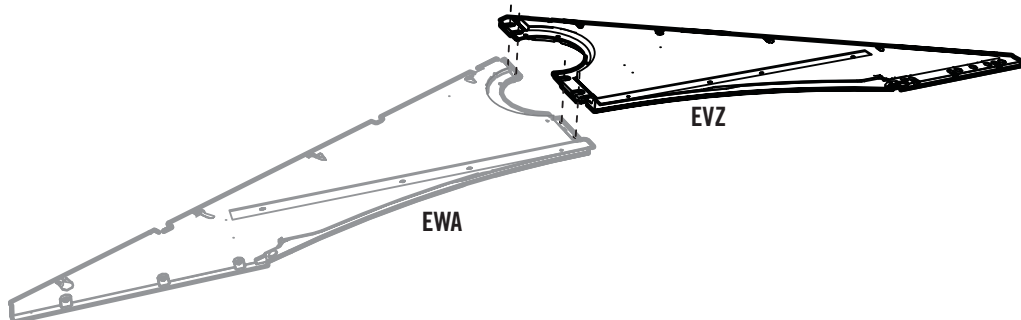

► SECTION 3 (CONTINUED) / SECTION 3 (SUITE) / SECCIÓN 3 (CONTINUACIÓN)

TOOLS AND HARDWARE REQUIRED / OUTILS ET QUINCAILLERIE REQUIS / INSTRUMENTAL Y HERRAJE REQUERIDOS



ADW (x5)

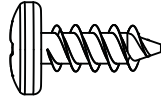

ADZ (x2)

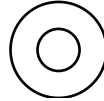

AEE (x7)

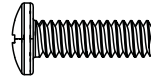

EYQ (x2)



CXK (x2)



AHS (x2)

3.6

- Secure with the hardware included. **Do not overtighten.**
- Fixer à l'aide de la quincaillerie incluse. **Ne pas trop serrer.**
- Sujetar con el herraje incluido. **No apretar demasiado.**

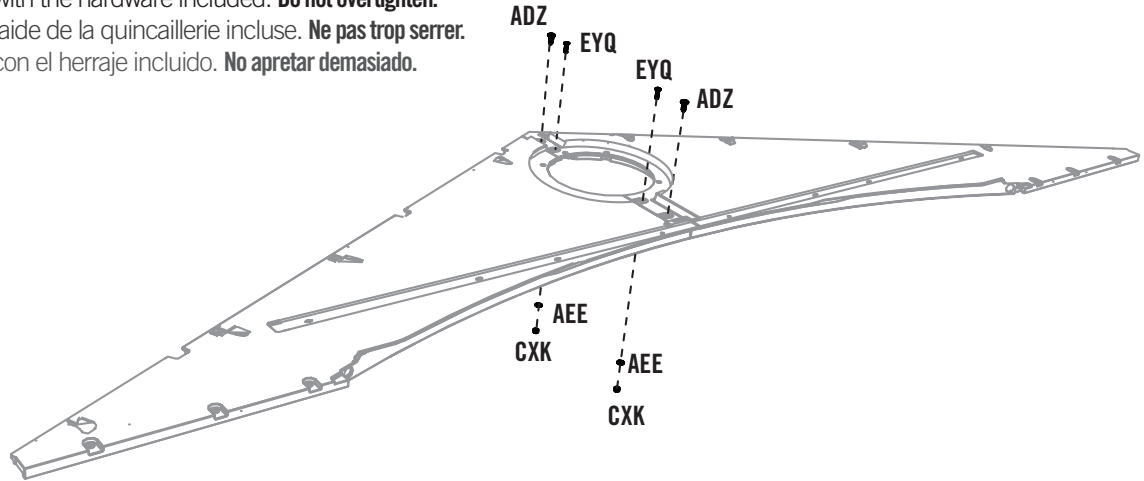

3.7

- Repeat steps 3.3–3.4 for the entry gable.
- Répéter les étapes 3.3 – 3.4 pour le pignon d'entrée.
- Repetir los pasos 3.3–3.4 para la fachada de entrada.

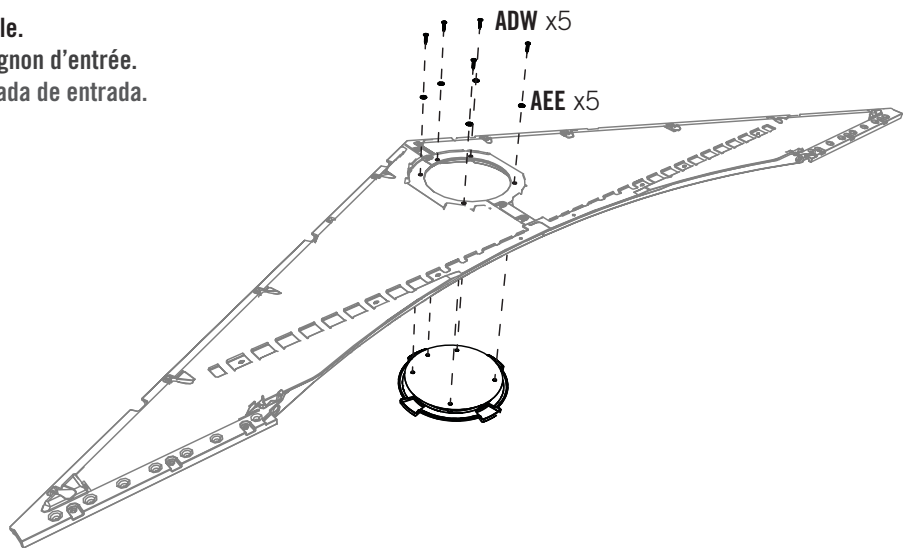
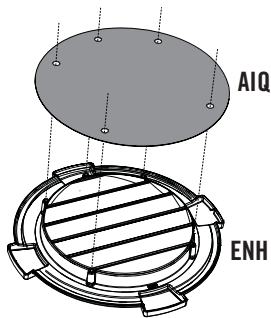

3.8

- Insert an **end cap (AHS)** into each end of the **header (EYS)**.
- Insérer un **capuchon (AHS)** dans chaque extrémité du **linteau (EYS)**.
- Insertar un **tapón (AHS)** en cada extremo del **dintel (EYS)**.

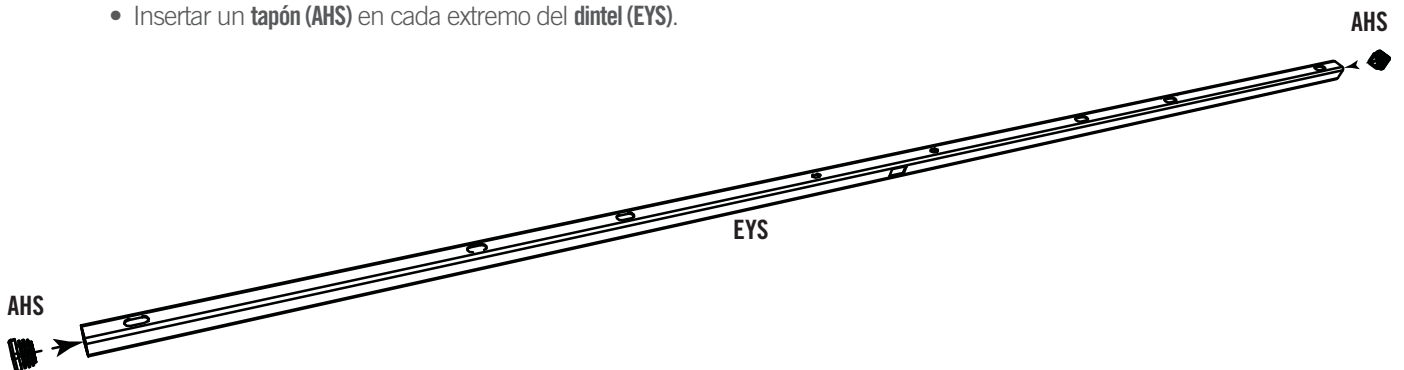

► SECTION 3 (CONTINUED) / SECTION 3 (SUITE) / SECCIÓN 3 (CONTINUACIÓN)

TOOLS AND HARDWARE REQUIRED / OUTILS ET QUINCAILLERIE REQUIS / INSTRUMENTAL Y HERRAJE REQUERIDOS

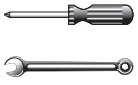

3/8 in/po
(≈10 mm)

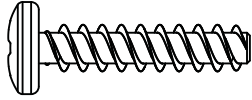

ADV (x6)

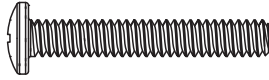

EYR (x2)

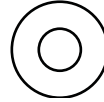

AEE (x2)



ADK (x2)

3.9

- Align the holes in the header with those in the gable.
- Aligner les trous dans le linteau avec ceux dans le pignon.
- Alinear los agujeros en el dintel con los de la fachada.



*The flat holes face away from the gable.
Les trous plats font face de l'autre côté du pignon.
Los agujeros lisos miran en contra de la fachada.*

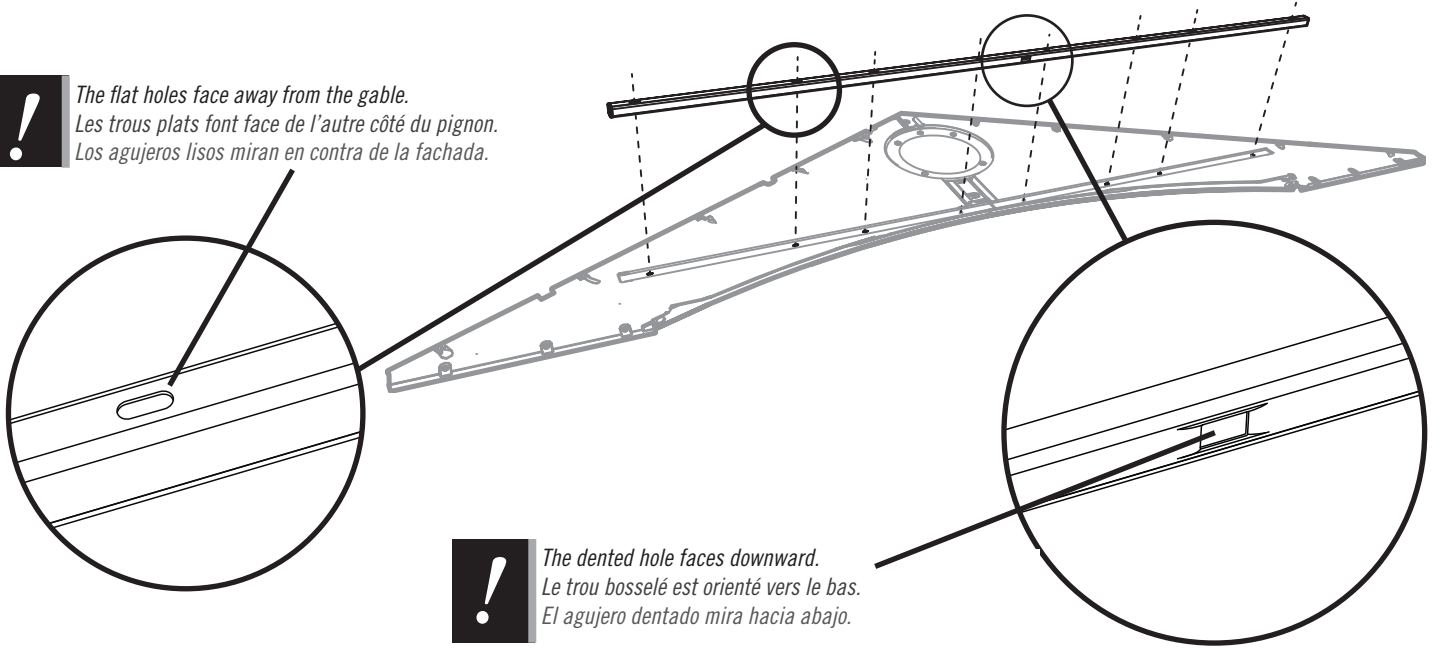

*The dented hole faces downward.
Le trou bosselé est orienté vers le bas.
El agujero dentado mira hacia abajo.*

3.10

- Secure with two (2) **screws (EYR)**, two (2) **washers (AEE)**, and two (2) **nuts (ADK)**. **Do not overtighten.**
- Le fixer à l'aide de deux (2) **vis (EYR)**, deux (2) **rondelles (AEE)**, et deux **écrous (ADK)**. **Ne pas trop serrer.**
- Sujetarlo con dos (2) **tornillos (EYR)**, dos (2) **rondanas (AEE)**, y dos **tuercas (ADK)**. **No apretar demasiado.**

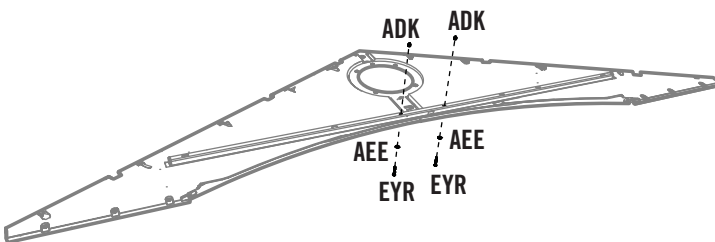

3.11

- Secure with six (6) more **screws (ADV)**.
- Le fixer à l'aide de six (6) **vis (ADV)** de plus.
- Sujetarlo con seis (6) más **tornillos (ADV)**.

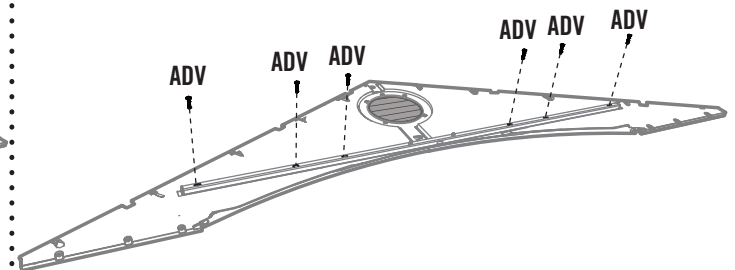

4

LEFT DOOR ASSEMBLY / ASSEMBLAGE DE LA PORTE GAUCHE / ENSAMBLAJE DE LA PUERTA IZQUIERDA



HARDWARE REQUIRED / QUINCAILLERIE REQUISE / HERRAJE REQUERIDO

Hardware Bags / Sacs de quincaillerie / Bolsas de herraje

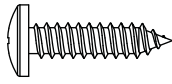

ADW (x3)

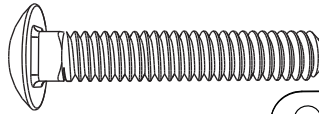

ABU (x2)



ADJ (x2)



AEE (x3)

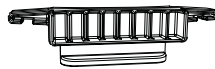

AHM (x2)



AIA (x1)

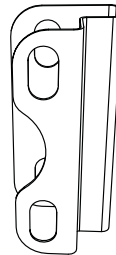

AIB (x1)

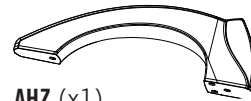

AHZ (x1)



PARTS REQUIRED / PIÈCES REQUISES / PIEZAS REQUERIDAS

Metal Parts / Pièces en métal / Piezas de metal

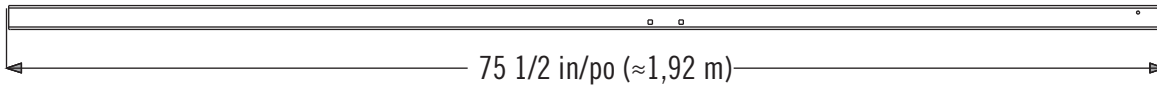

AFC (x1)

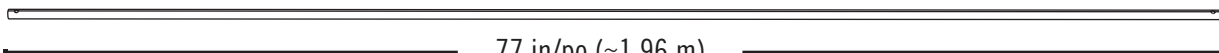
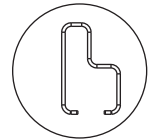

CRD (x1)

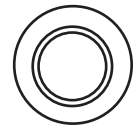

Plastic Parts / Pièces en plastique / Piezas de plástico

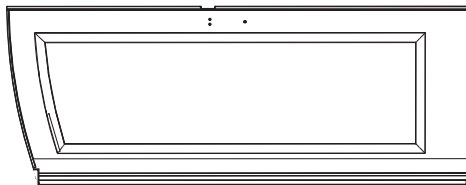

BDJ (x1)



TOOLS REQUIRED (NOT INCLUDED—UNLESS INDICATED OTHERWISE*) / OUTILS REQUIS (NON INCLUS — SAUF INDICATION CONTRAIRE*) / INSTRUMENTAL REQUERIDO (NO INCLUIDO, SALVO INDICACIÓN CONTRARIA*)



7/16 in/po (≈11 mm)

► SECTION 4 (CONTINUED) / SECTION 4 (SUITE) / SECCIÓN 4 (CONTINUACIÓN)

TOOLS AND HARDWARE REQUIRED / OUTILS ET QUINCAILLERIE REQUIS / INSTRUMENTAL Y HERRAJE REQUERIDOS



- In case of any trouble with this section, scan the QR code below to view a video on its assembly.
- En cas de problème avec cette section, scanner le QR code en dessous pour voir une vidéo de l'assemblage.
- En caso de problemas con esta sección, escanear el código QR debajo para ver un video del ensamblaje.



<http://go.Lifetime.com/8x10storageshed-section4>

4.1

- Slide a **hinge tube (CRD)** down into the hole at the top of the **left door (BDJ)**.
- Faire glisser le **tube d'articulation (CRD)** dans le trou au bord supérieur de la **porte gauche (BDJ)**.
- Deslizar el **tubo de articulación (CRD)** en el agujero a la parte superior de la **puerta izquierda (BDJ)**.

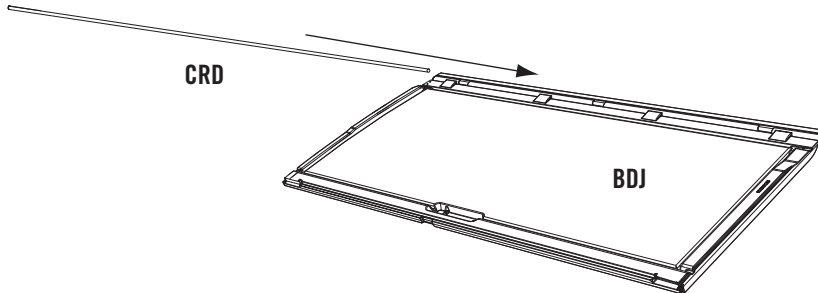

- Door channels (AFC) are bowed by design, ensuring a tight fit when they are closed and latched, making your shed more secure. These channels are formed with a slight bend to the adjoining door edge—like parentheses facing each other: (). When the door handle is gently closed and latched, there should be a slight pressure sealing the doors and eliminating any gaps. Be sure to read the step-by-step instructions carefully to successfully install the door channels.
- Les canaux pour le bord des portes (AFC) sont courbés par design, en s'assurant un ajustage lorsque les portes se ferment, en faisant l'abri plus sûre. Ces canaux sont fabriqués avec une légère courbe au bord de la porte adjacent — comme les parenthèses qui font face l'une l'autre : (). Lorsque la poignée se ferme, il devrait y avoir une légère pression en rebouchant les portes et en éliminant des ouvertures. Veillez à lire avec soin les instructions étape par étape pour pouvoir installer avec succès les canaux pour le bord des portes.
- Los canales para el borde de las puertas (AFC) son curvados por diseño, asegurando un ajuste fijo cuando las puertas estén cerradas con pestillo, haciendo la caseta más segura. Estos canales están formados con una curva ligera al borde de la puerta adyacente, como los paréntesis uno enfrente al otro: (). Cuando el picaporte esté ligeramente cerrado con pestillo, debería tener una presión ligera sellando las puertas y eliminando los espacios. Asegurarse de leer detenidamente las instrucciones paso a paso para poder instalar exitosamente los canales para el borde de las puertas.



AFC

► SECTION 4 (CONTINUED) / SECTION 4 (SUITE) / SECCIÓN 4 (CONTINUACIÓN)

TOOLS AND HARDWARE REQUIRED / OUTILS ET QUINCAILLERIE REQUIS / INSTRUMENTAL Y HERRAJE REQUERIDOS



AHM (x2)



AIB (x1)

4.2

- Set the **deadbolts (AHM)** down into the recesses at the top and bottom of the door. Then, slide the **door end channel (AFC)** over the edge of the door and the bottom of the deadbolts as shown.
- Mettre les **loquets à pêne dormant (AHM)** dans les espaces vides aux parties supérieure et inférieure de la porte. Ensuite, faire glisser le **canal de la porte (AFC)** sur le bord de la porte et les parties inférieures des loquets à pêne dormant comme illustré.
- Poner los **cerrojos (AHM)** en los huecos a las partes superior e inferior de la puerta. Entonces, deslizar el **canal para el borde de la puerta (AFC)** sobre el borde de la puerta y las partes inferiores de los cerrojos como se muestra.

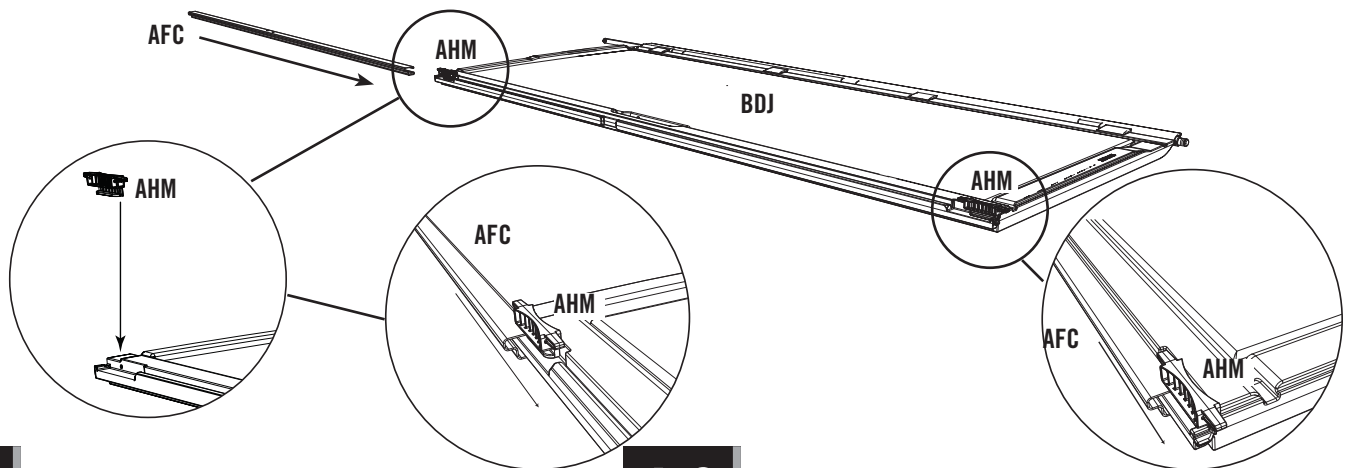

4.3

- *Note: The deadbolts are used for locking the door. They may not move freely at first. You may need to tap them up and down a few times with a rubber mallet to work them in.*
- *Remarque : Les loquets s'utilisent pour fermer la porte. Au début, il se peut que les Loquets ne se déplaceraient librement. Il faut peut-être les taper légèrement à l'aide d'un maillet en caoutchouc pour les desserrer.*
- *Nota: Se usan los cerrojos para cerrar la puerta. Al principio, pueden que no se desplacen libremente. Si es necesario, darlos unos golpecitos con un mazo de goma para aflojarlos.*

- Slide the **strike plate (AIB)** over the door end channel, and align the holes.
- Faire glisser la **poignée (AIB)** sur le canal de la porte, et aligner les trous.
- Deslizar la **placa de impacto (AIB)** sobre el canal de la puerta, y alinear los agujeros.

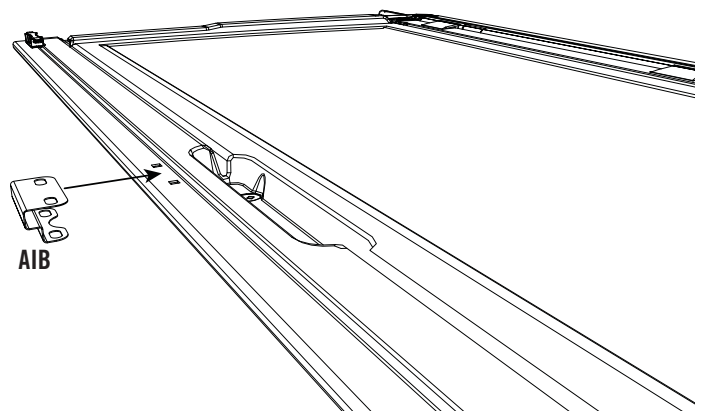
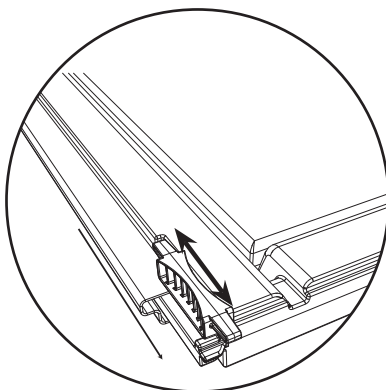

► SECTION 4 (CONTINUED) / SECTION 4 (SUITE) / SECCIÓN 4 (CONTINUACIÓN)

TOOLS AND HARDWARE REQUIRED / OUTILS ET QUINCAILLERIE REQUIS / INSTRUMENTAL Y HERRAJE REQUERIDOS



7/16 in/po
(≈11 mm)



ADW (x3)

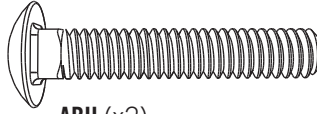

ABU (x2)

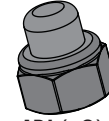

ADJ (x2)

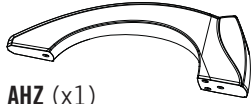

AHZ (x1)

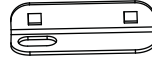

AIA (x1)

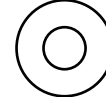

AEE (x3)

4.4

- Attach the **door latch (AIA)** to the door using the hardware included. **Do not overtighten.**
- Attacher le **loquet (AIA)** à la porte à l'aide de la quincaillerie incluse. **Ne pas trop serrer.**
- Sujetar la **placa de cierre (AIA)** a la puerta usando el herraje incluido. **No apretar demasiado.**

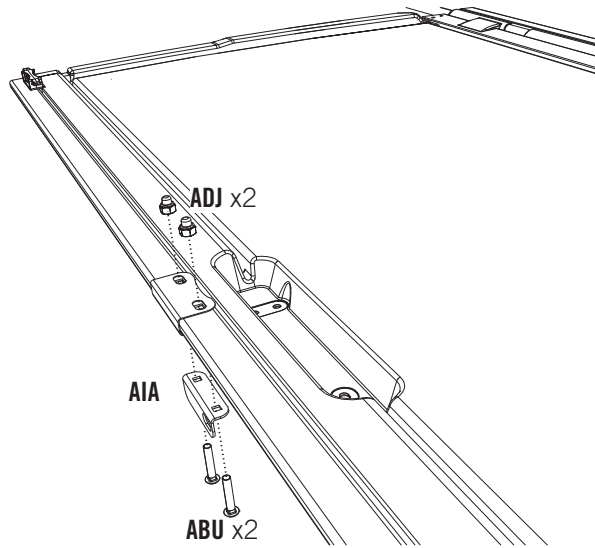

4.5

- Attach the **handle (AHZ)** using the hardware included.
- Attacher la **poignée (AHZ)** à l'aide de la quincaillerie incluse.
- Sujetar el **picaporte (AHZ)** usando el herraje incluido.

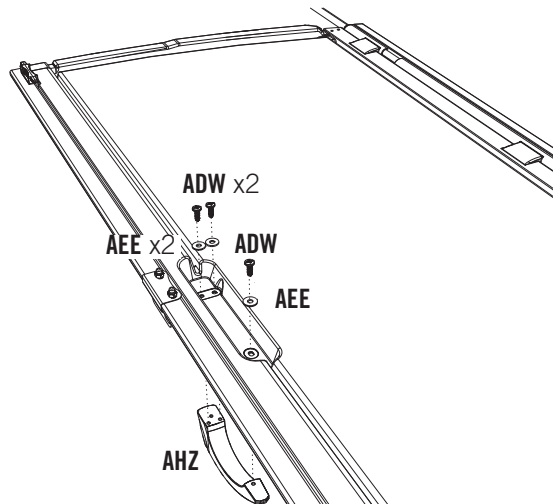



HARDWARE REQUIRED / QUINCAILLERIE REQUISE / HERRAJE REQUERIDO

Hardware Bag / Sac de quincaillerie / Bolsa de herraje



* Not all hardware will be used in the section.
 * La quincaillerie n'est pas utilisée au complet dans la section.
 * No se utilizará todo el herraje en la sección.

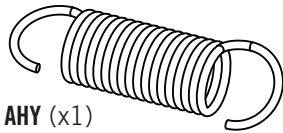

AHY (x1)

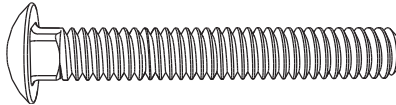

ABV (x2)

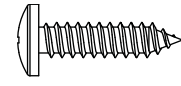

ADW (x4)

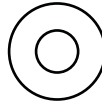

AEE (x5)*

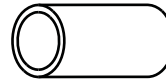

ADB (x2)

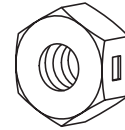

AAB (x2)



AEB (x2)

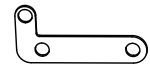

AHX (x1)

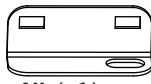

AIL (x1)

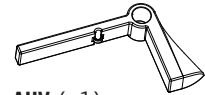

AHV (x1)

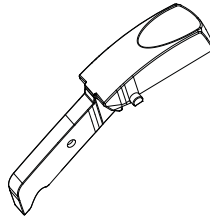

AIO (x1)

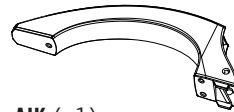

AIK (x1)

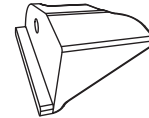

AHW (x1)



PARTS REQUIRED / PIÈCES REQUISES / PIEZAS REQUERIDAS

Metal Parts / Pièces en métal / Piezas de metal

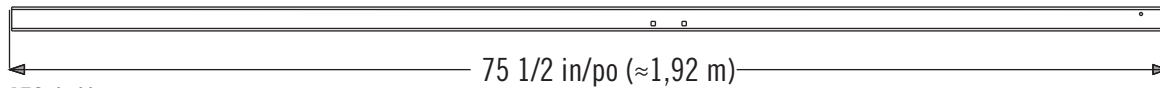

AFC (x1)

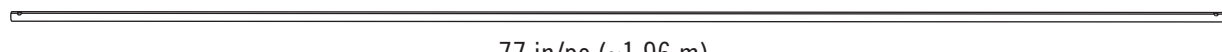
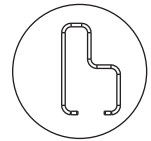

CRD (x1)

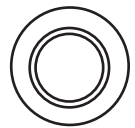

Plastic Parts / Pièces en plastique / Piezas de plástico

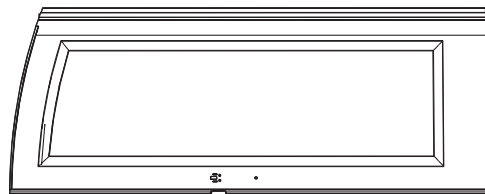

BDK (x1)



TOOLS REQUIRED (NOT INCLUDED—UNLESS INDICATED OTHERWISE*) / OUTILS REQUIS (NON INCLUS — SAUF INDICATION CONTRAIRE*) / INSTRUMENTAL REQUERIDO (NO INCLUIDO, SALVO INDICACIÓN CONTRARIA*)



7/16 in/po (≈11 mm)

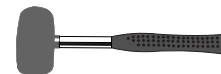
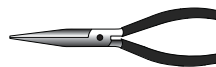

► SECTION 5 (CONTINUED) / SECTION 5 (SUITE) / SECCIÓN 5 (CONTINUACIÓN)

TOOLS AND HARDWARE REQUIRED / OUTILS ET QUINCAILLERIE REQUIS / INSTRUMENTAL Y HERRAJE REQUERIDOS



- In case of any trouble with this section, scan the QR code below to view a video on its assembly.
- En cas de problème avec cette section, scanner le QR code en dessous pour voir une vidéo de l'assemblage.
- En caso de problemas con esta sección, escanear el código QR debajo para ver un video del ensamblaje.



<http://go.Lifetime.com/8x10storageshed-section5>

5.1

- Slide a **hinge tube (CRD)** down into the hole at the top of the **right door (BDK)**.
- Faire glisser le **tube d'articulation (CRD)** dans le trou au bord supérieur de la **porte droite (BDK)**.
- Deslizar el **tubo de articulación (CRD)** en el agujero a la parte superior de la **puerta derecha (BDK)**.

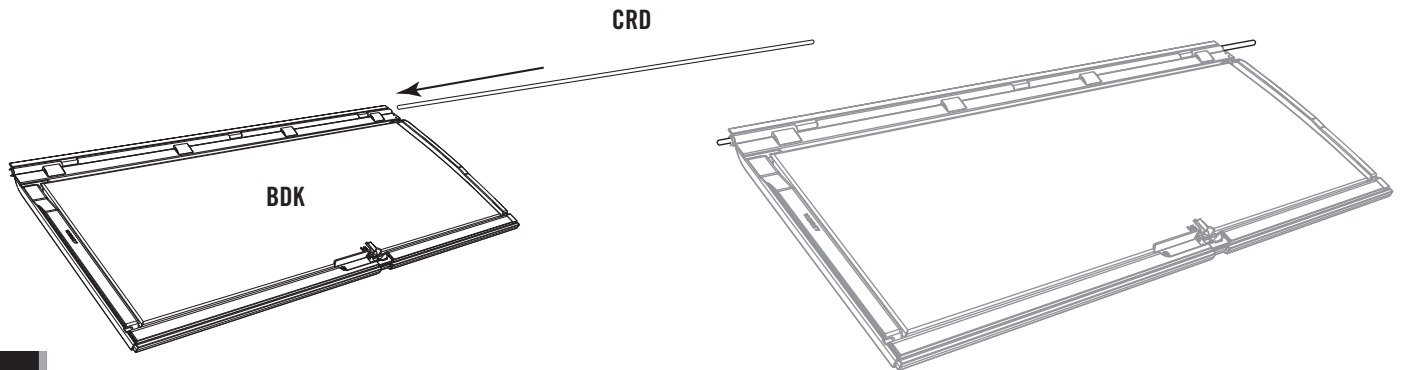

- Door channels (AFC) are bowed by design, ensuring a tight fit when they are closed and latched, making your shed more secure. These channels are formed with a slight bend to the adjoining door edge—like parentheses facing each other: (). When the door handle is gently closed and latched, there should be a slight pressure sealing the doors and eliminating any gaps. Be sure to read the step-by-step instructions carefully to successfully install the door channels.
- Les canaux pour le bord des portes (AFC) sont courbés par design, en s'assurant un ajustage lorsque les portes se ferment, en faisant votre abri plus sûr. Ces canaux sont fabriqués avec une légère courbe au bord de la porte adjacente — comme les parenthèses qui font face l'une l'autre : (). Lorsque la poignée se ferme, il devrait y avoir une légère pression en rebouchant les portes et en éliminant des ouvertures. Veillez à lire avec soin les instructions étape par étape pour pouvoir installer avec succès les canaux pour le bord des portes.
- Los canales para el borde de las puertas (AFC) son curvados por diseño, asegurando un ajuste fijo cuando las puertas estén cerradas con pestillo, haciendo su caseta más segura. Estos canales están formados con una curva ligera al borde de la puerta adyacente, como los paréntesis uno enfrente al otro: (). Cuando el picaporte esté ligeramente cerrado con pestillo, se tiene una presión ligera sellando las puertas y eliminando los espacios. Asegurarse de leer detenidamente las instrucciones paso a paso para poder instalar exitosamente los canales para el borde de las puertas.



AFC

► SECTION 5 (CONTINUED) / SECTION 5 (SUITE) / SECCIÓN 5 (CONTINUACIÓN)

TOOLS AND HARDWARE REQUIRED / OUTILS ET QUINCAILLERIE REQUIS / INSTRUMENTAL Y HERRAJE REQUERIDOS

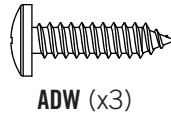
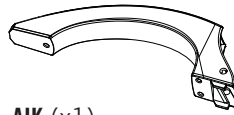
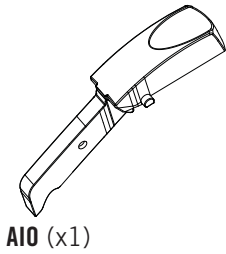
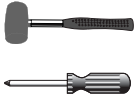

5.2

- Slide the **door end channel (AFC)** over the edge of the door as shown.
- Faire glisser le **canal de la porte (AFC)** sur le bord de la porte comme illustré.
- Deslizar el **canal para el borde de la puerta (AFC)** sobre el borde de la puerta como se muestra.

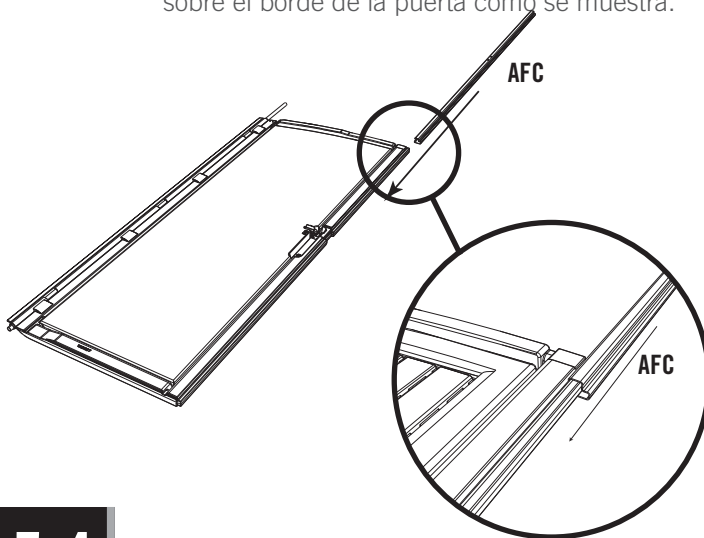

5.3

- Slide the **thumb lever (AIO)** down into the grooves in the **door handle (AIK)** until the nubs fit into the holes.
- Faire glisser le **levier poussoir (AIO)** dans les rainures de la **poignée (AIK)** jusqu'à ce que les petites bosses se fixent dans les trous.
- Deslizar la **palanca de pulgar (AIO)** en las ranuras del **picaporte (AIK)** hasta que los nudos se encajen en los agujeros.

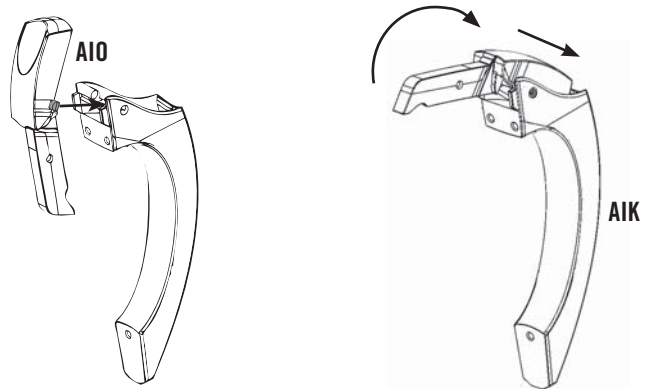

5.4

- Attach the handle using the hardware included.
- Attacher la poignée à l'aide de la quincaillerie incluse.
- Sujetar el picaporte usando el herraje incluido.

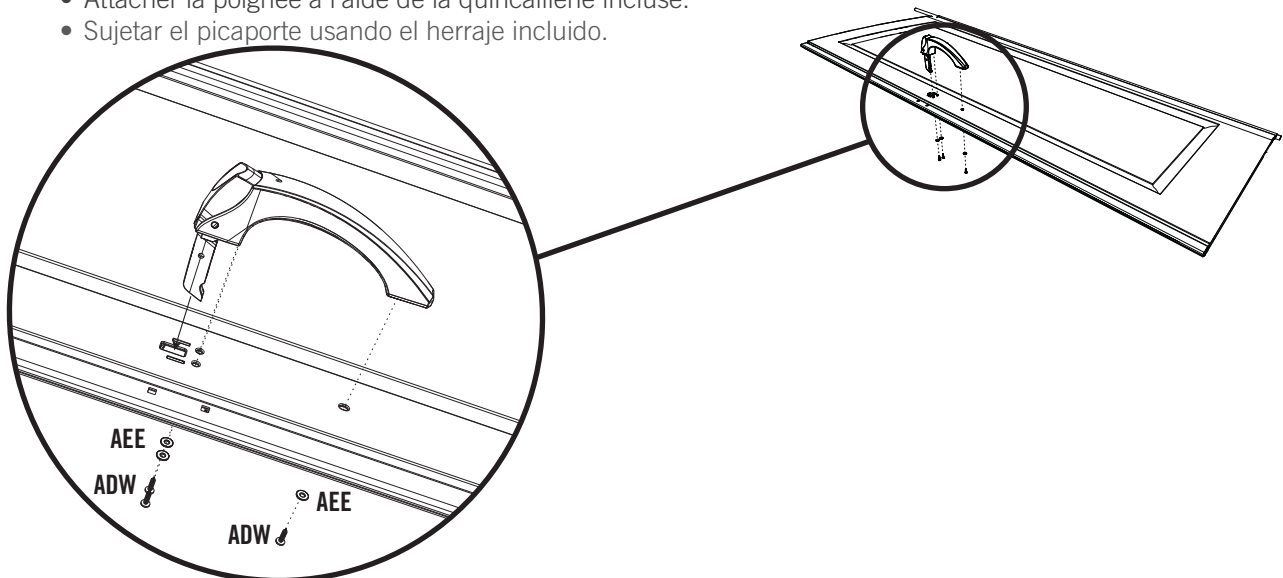

► SECTION 5 (CONTINUED) / SECTION 5 (SUITE) / SECCIÓN 5 (CONTINUACIÓN)

TOOLS AND HARDWARE REQUIRED / OUTILS ET QUINCAILLERIE REQUIS / INSTRUMENTAL Y HERRAJE REQUERIDOS



7/16 in/po
(≈11 mm)

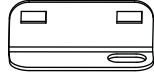

AIL (x1)

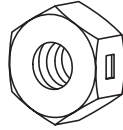

AAB (x2)

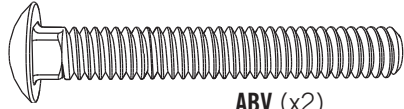

ABV (x2)

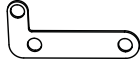

AHX (x1)

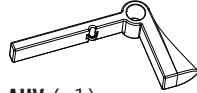

AHV (x1)



ADB (x2)

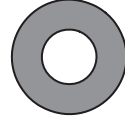

AEB (x2)

5.5

- Attach the Locking Hardware using the hardware included. **The arm of the Latch rests on top of the Thumb Lever.**
- Attacher les accessoires de verrouillage à l'aide de la quincaillerie incluse. **Le bras du Loquet doit rester sur le Levier poussoir.**
- Sujetar los accesorios de cierre usando el herraje incluido. **El brazo del pestillo se queda sobre la palanca de pulgar.**

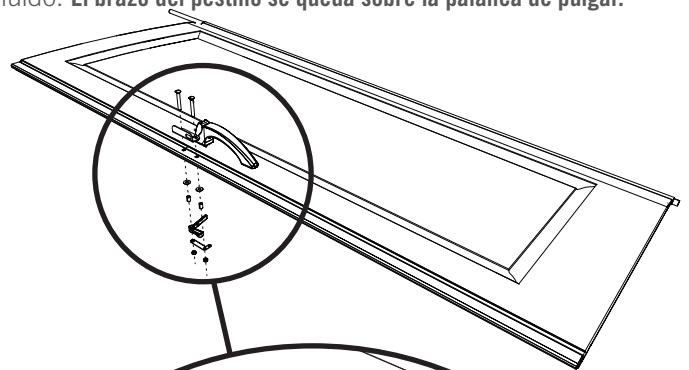

Thumb lever
Levier poussoir
Palanca de pulgar

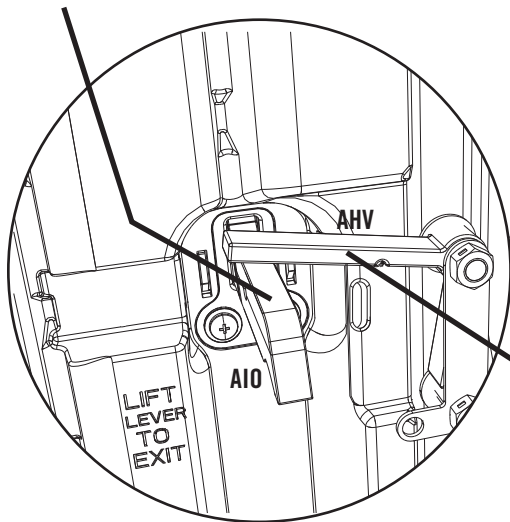

Arm of latch
Bras du loquet
Brazo del pestillo

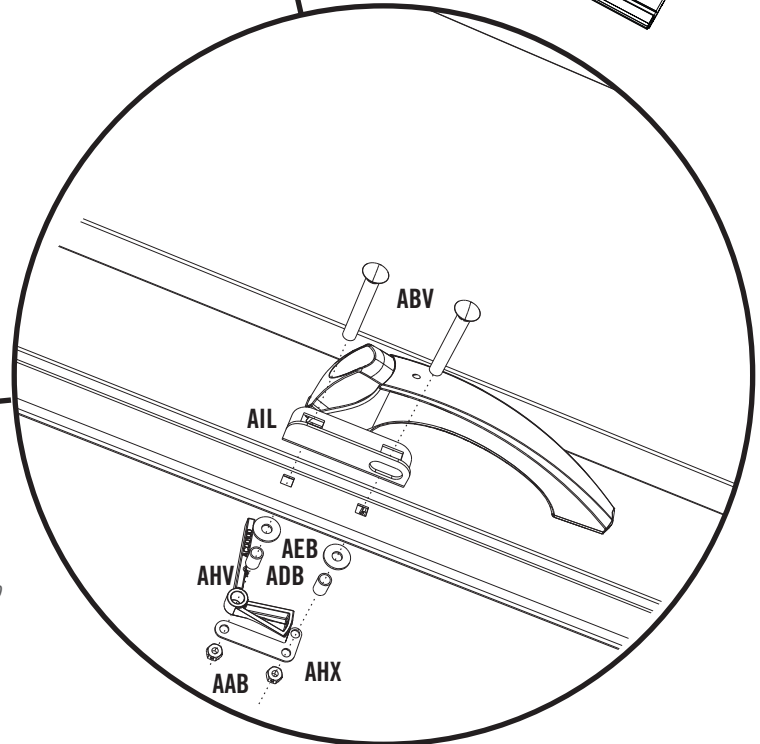

Rear of door / Arrière de la porte / Trasero de la puerta

► SECTION 5 (CONTINUED) / SECTION 5 (SUITE) / SECCIÓN 5 (CONTINUACIÓN)

TOOLS AND HARDWARE REQUIRED / OUTILS ET QUINCAILLERIE REQUIS / INSTRUMENTAL Y HERRAJE REQUERIDOS

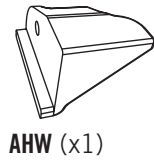
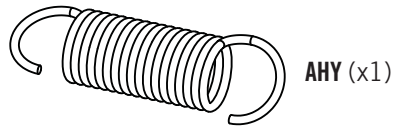
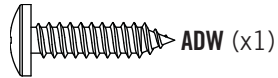
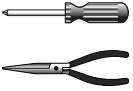

5.6

- Attach the **bracket (AHW)** using a **screw (ADW)**, and attach the **spring (AHY)**.
- Attacher le **support (AHW)** à l'aide d'une **vis (ADW)**, et attacher le **ressort (AHY)**.
- Sujetar el **soporte (AHW)** usando un **tornillo (ADW)**, y sujetar el **resorte (AHY)**.

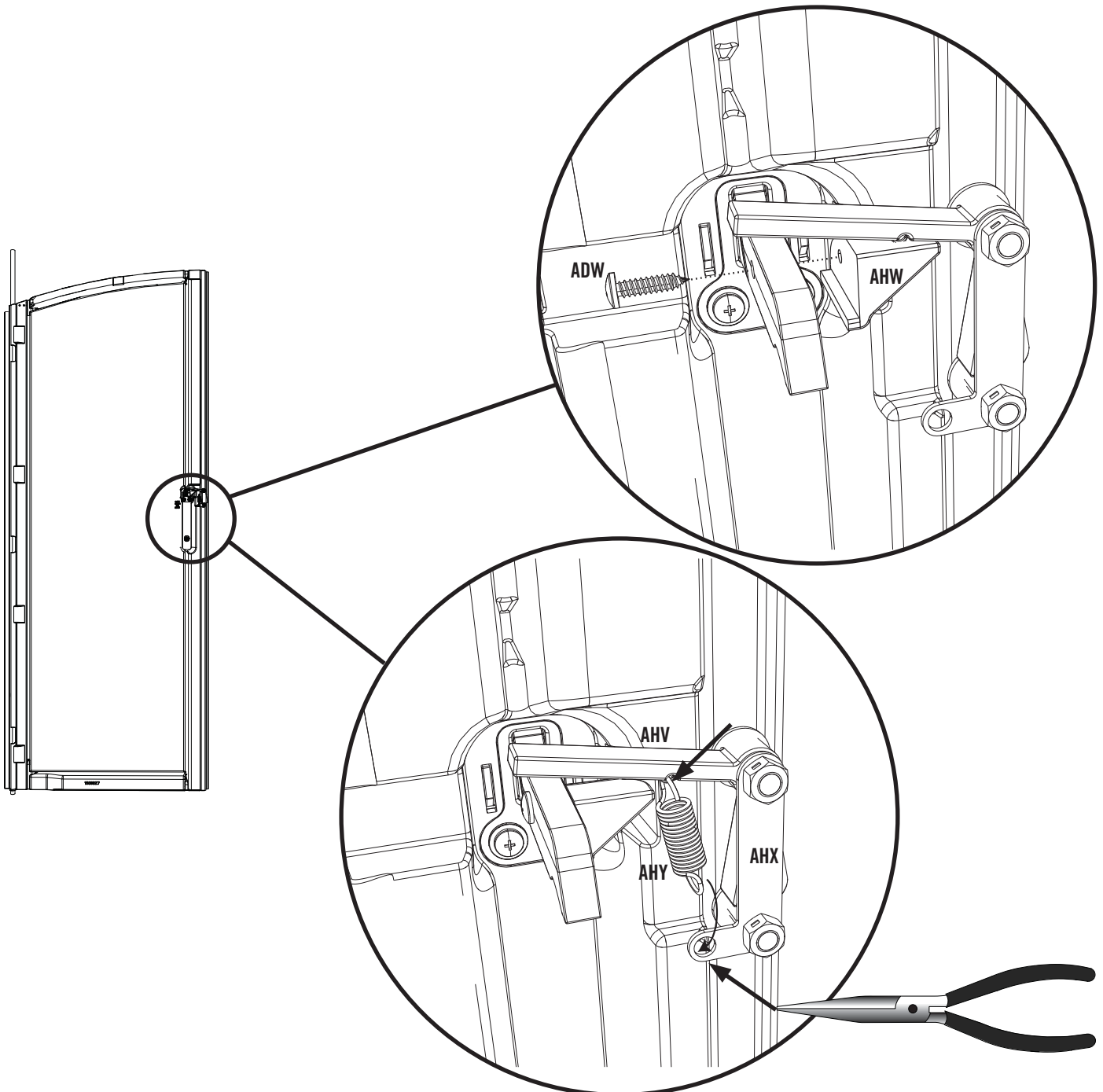

6

FLOOR ASSEMBLY / ASSEMBLAGE DU PLANCHER / ENSAMBLAJE DEL PISO



HARDWARE REQUIRED / QUINCAILLERIE REQUISE / HERRAJE REQUERIDO

Hardware bag / Sac de quincaillerie / Bolsa de herraje

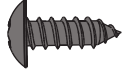

CWU (x18)



ADC (x1)

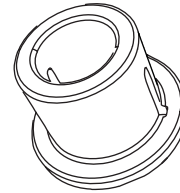

AHO (x2)



*These screws do not anchor the floor; they only hold the panels together.
Ces vis n'ancrent pas le plancher ; ils ne servent que pour attacher les panneaux les uns aux autres.
Estos tornillos no anclan el piso; sirven sólo para sujetar los paneles los unos a los otros.*



PARTS REQUIRED / PIÈCES REQUISES / PIEZAS REQUERIDAS

Plastic parts / Pièces en plastique / Piezas de plástico

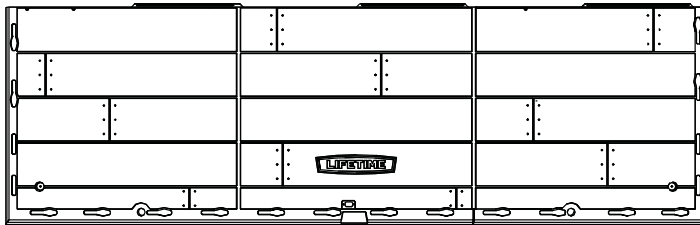

CUW (x2)

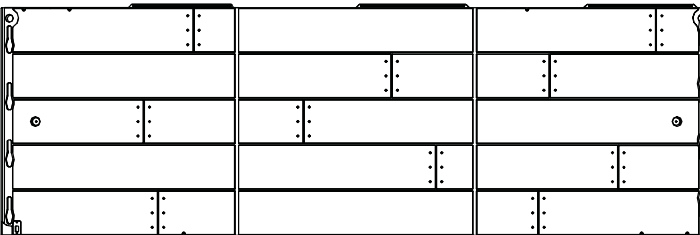

CUD (x2)

- *Unfold the floor panels before installing.*
- *Dépliez les panneaux de sol avant l'installation.*
- *Despliegue los paneles del suelo antes de instalar.*



TOOLS REQUIRED (NOT INCLUDED—UNLESS INDICATED OTHERWISE*) / OUTILS REQUIS (NON INCLUS — SAUF INDICATION CONTRAIRE*) / INSTRUMENTAL REQUERIDO (NO INCLUIDO, SALVO INDICACIÓN CONTRARIA*)



► SECTION 6 (CONTINUED) / SECTION 6 (SUITE) / SECCIÓN 6 (CONTINUACIÓN)

TOOLS AND HARDWARE REQUIRED / OUTILS ET QUINCAILLERIE REQUIS / INSTRUMENTAL Y HERRAJE REQUERIDOS



- In case of any trouble with this section, scan the QR code below to view a video on its assembly.
- En cas de problème avec cette section, scanner le QR code en dessous pour voir une vidéo de l'assemblage.
- En caso de problemas con esta sección, escanear el código QR debajo para ver un video del ensamblaje.



<http://go.Lifetime.com/8x10storageshed-section6>

6.1

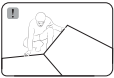

- Hold an **inner floor panel (CUD)** at a 45° angle and slide the tabs along the edge underneath an **outer floor panel (CUW)**. The tabs interlock. Lay Panel flat.
- Poser un **panneau de plancher intérieur (CUD)** à un angle de 45° et faire glisser les languettes le long du bord au-dessus du **panneau de plancher extérieur (CUW)**. Les languettes s'enclenchent les uns les autres. L'étendre par terre.
- Colocar un **panel de piso interior (CUD)** a un ángulo de 45° y deslizar las lengüetas a lo largo del borde debajo el **panel de piso exterior (CUW)**. Las lengüetas se entrelazan las unas con las otras. Aplanar el panel.

Back
Arrière
Volver

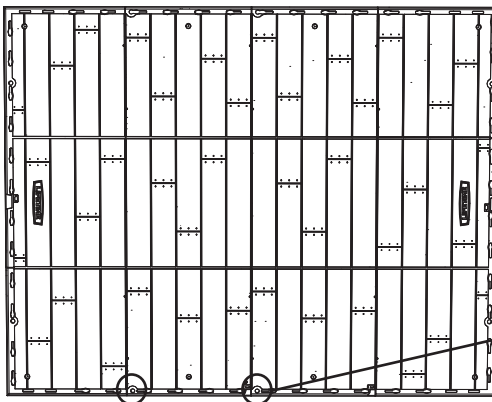

Front
Avant
Frente

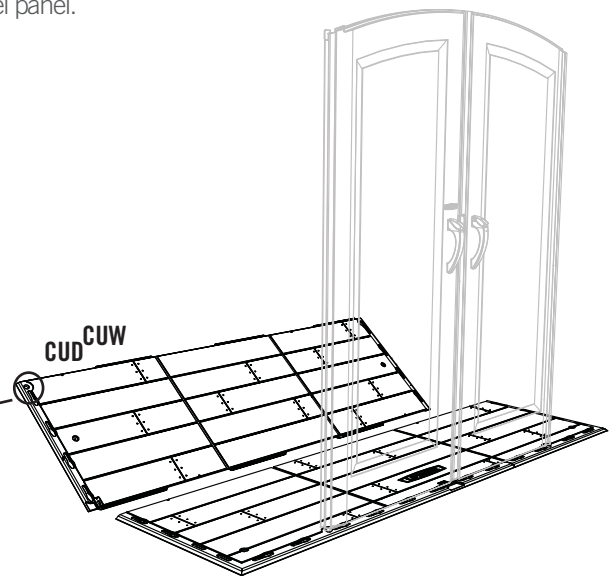

► SECTION 6 (CONTINUED) / SECTION 6 (SUITE) / SECCIÓN 6 (CONTINUACIÓN)

TOOLS AND HARDWARE REQUIRED / OUTILS ET QUINCAILLERIE REQUIS / INSTRUMENTAL Y HERRAJE REQUERIDOS

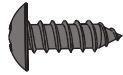

CWU (x18)



AHO (x2)

6.2

- Attach the second **inner floor panel (CUD)** to the first inner floor panel.
- Attacher le deuxième **panneau de plancher intérieur (CUD)** au premier panneau de plancher intérieur.
- Fijar el segundo **panel de piso interior (CUD)** al primer panel de piso interior.

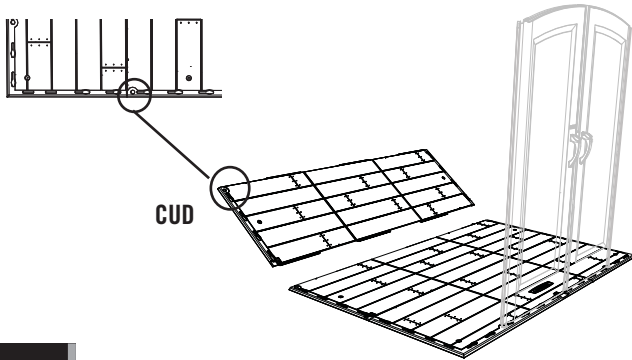

6.3

- Then, attach an **outer floor panel (CUW)** to the inner floor panel. Insert the **bushings (AHO)**.
- Ensuite, attacher un autre **panneau de plancher intérieur (CUW)** au panneau de plancher intérieur. Insérer les **bagues (AHO)**.
- Entonces, fijar otro **panel de piso exterior (CUW)** al panel de piso interior. Insertar los **casquillos (AHO)**.

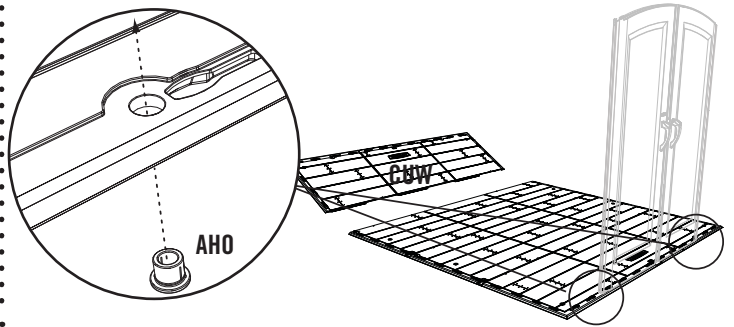

6.4

- Finally, insert the **screws (CWU)** through the divots in the floor panels and into the tabs of the adjacent floor panels. (The divots are near the seams of the floor panels.) *These screws do not anchor the floor; they only hold the panels together.*
- Enfin, insérer les **vis (CWU)** à travers les marques dans les panneaux de plancher et dans les languettes du panneaux de plancher contigu. (Les marques se trouvent près des jonctions des panneaux de plancher.) *Ces vis n'ancrent pas le plancher ; ils ne servent que pour attacher les panneaux les uns aux autres.*
- Por último, insertar los **tornillos (CWU)** a través de las marcas en los paneles de piso y dentro de las lengüetas de los paneles de piso adyacentes. (Se encuentran las marcas cerca de las juntas de los paneles de piso.) *Estos tornillos no anclan el piso; sirven sólo para sujetar los paneles los unos a los otros.*

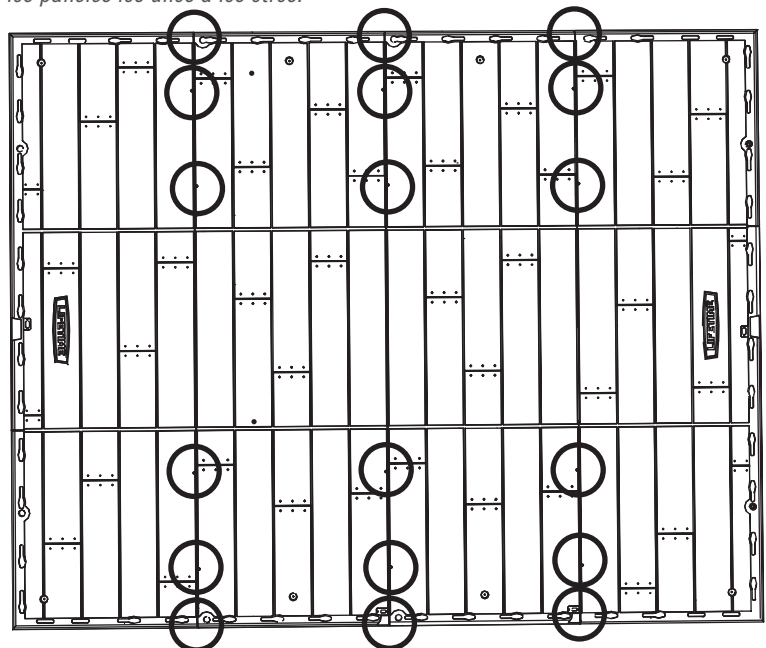
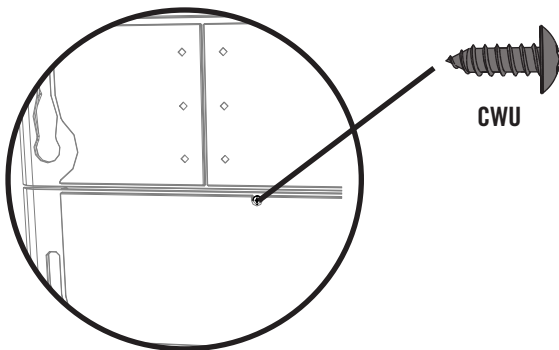

7

WALL ASSEMBLY / ASSEMBLAGE DES MURS / ENSAMBLE DE LOS MUROS



HARDWARE REQUIRED / QUINCAILLERIE REQUISE / HERRAJE REQUERIDO

Hardware Bag / Sac de quincaillerie / Bolsa de herraje

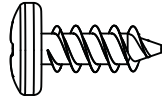

ADZ (x100)*

- * Not all hardware will be used in the section.
- * La quincaillerie n'est pas utilisée au complet dans la section.
- * No se utilizará todo el herraje en la sección.



PARTS REQUIRED / PIÈCES REQUISES / PIEZAS REQUERIDAS

Metal Parts / Pièces en métal / Piezas de metal

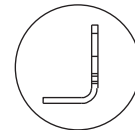
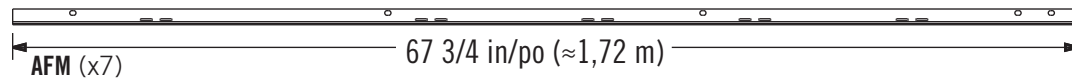

Plastic Parts / Pièces en plastique / Piezas de plástico

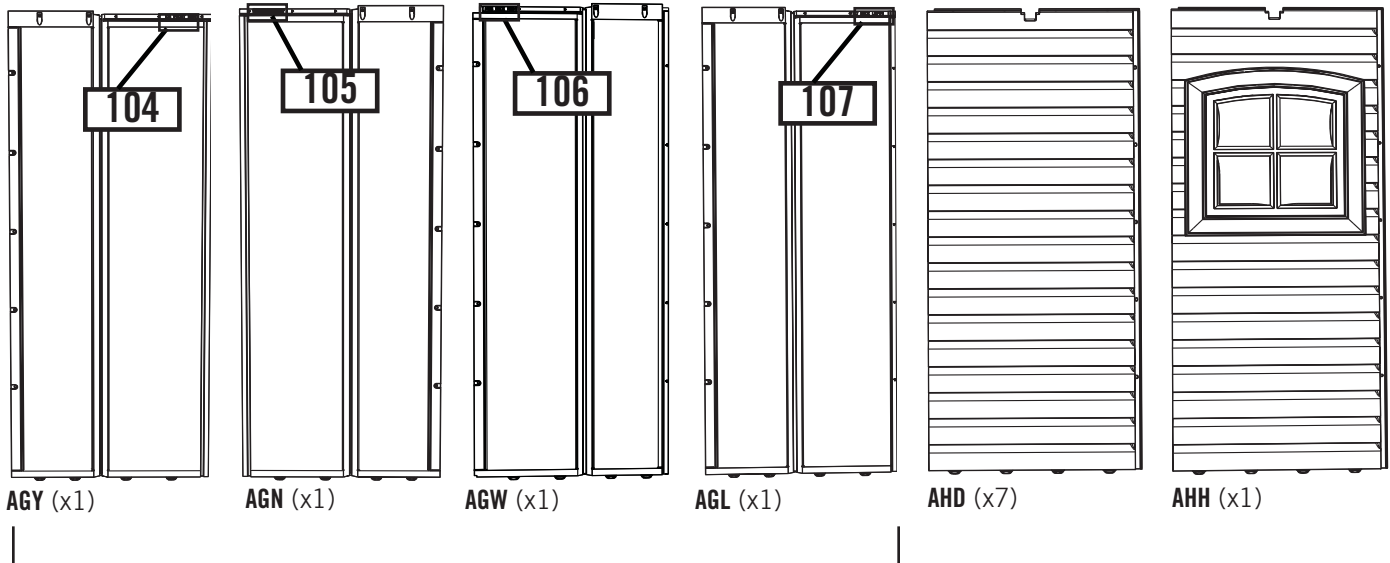

Back Surface of Panels / Surface arrière des panneaux / Superficie trasera de los paneles



TOOLS REQUIRED (NOT INCLUDED—UNLESS INDICATED OTHERWISE*) / OUTILS REQUIS (NON INCLUS — SAUF INDICATION CONTRAIRE*) / INSTRUMENTAL REQUERIDO (NO INCLUIDO, SALVO INDICACIÓN CONTRARIA*)



AIW (x1)

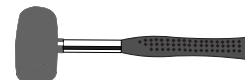

► SECTION 7 (CONTINUED) / SECTION 7 (SUITE) / SECCIÓN 7 (CONTINUACIÓN)

TOOLS AND HARDWARE REQUIRED / OUTILS ET QUINCAILLERIE REQUIS / INSTRUMENTAL Y HERRAJE REQUERIDOS

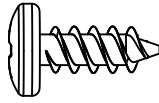

ADZ (x8)



- In case of any trouble with this section, scan the QR code below to view a video on its assembly.
- En cas de problème avec cette section, scanner le QR code en dessous pour voir une vidéo de l'assemblage.
- En caso de problemas con esta sección, escanear el código QR debajo para ver un video del ensamblaje.



<http://go.Lifetime.com/8x10storageshed-section7>

7.1

- Top end
- Extremo superior
- Extrémité supérieure



- No screw in top hole.
- Aucune vis dans le trou supérieur.
- Ningún tornillo en el agujero superior.

- Secure two **wall support channels (AFM)** at the outer edges on the one (1) **window panels (AHH)** using eight (8) **screws (ADZ)** for each.
- Fixez deux (2) **renforts de soutien mural (AFM)** sur les bords extérieurs de chacun des deux (2) **volets de fenêtre (AHH)** à l'aide de huit (8) **vis (ADZ)**.
- Asegure dos (2) **canales de soporte de pared (AFM)** en los bordes exteriores de los dos (2) **paneles de ventana (AHH)** utilizando ocho (8) **tornillos (ADZ)** para cada uno.

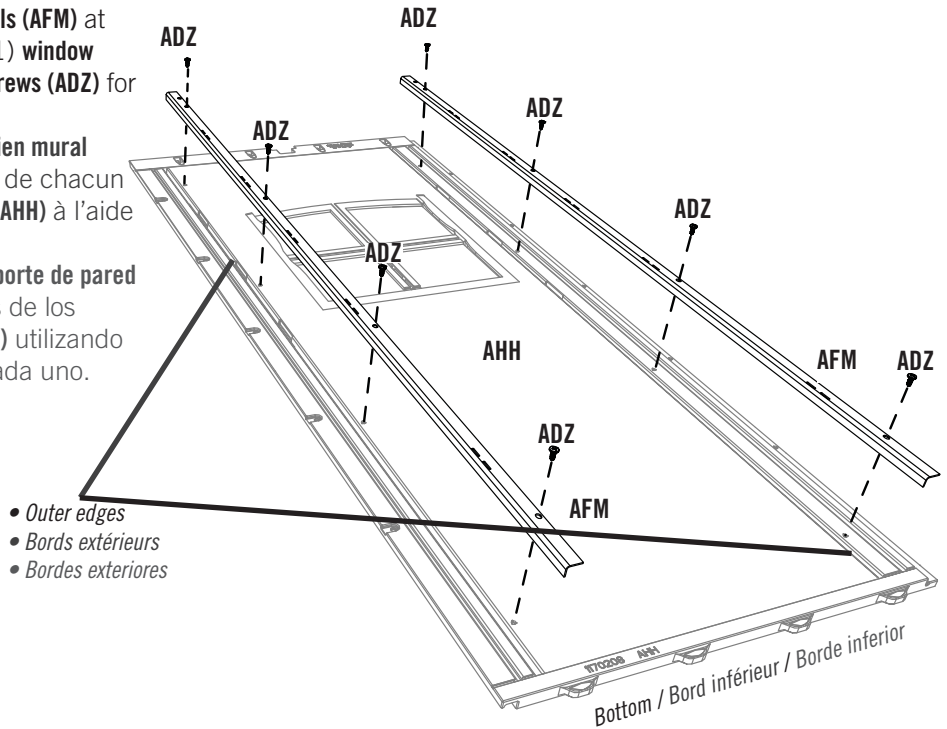

- Outer edges
- Bords extérieurs
- Bordes exteriores

► SECTION 7 (CONTINUED) / SECTION 7 (SUITE) / SECCIÓN 7 (CONTINUACIÓN)

TOOLS AND HARDWARE REQUIRED / OUTILS ET QUINCAILLERIE REQUIS / INSTRUMENTAL Y HERRAJE REQUERIDOS

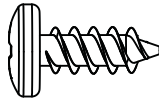

ADZ (x20)

7.2

- Top end
- Extrémité superior
- Extrémité supérieure



- No screw in top hole.
- Aucune vis dans le trou supérieur.
- Ningún tornillo en el agujero superior.

- Secure a **wall support channel (AFM)** at the middle of the notch on five (5) **wall panels (AHD)** using four (4) **screws (ADZ)** for each. The remaining two (2) wall panels will have the wall support channels installed in the next section.
- Fixez un **renfort de soutien mural (AFM)** au centre de l'encoche de chacun cinq (5) **panneaux muraux (AHD)** à l'aide de quatre (4) **vis (ADZ)**. Les deux (2) panneaux muraux restants auront les chenaux de support muraux installés dans la section suivante.
- Asegure un **canal de soporte de pared (AFM)** en el centro de la muesca en cinco (5) **paneles de pared (AHD)** utilizando cuatro (4) **tornillos (ADZ)** para cada uno. Los canales de apoyo para la pared de los dos (2) paneles restantes se instalarán en la siguiente sección.

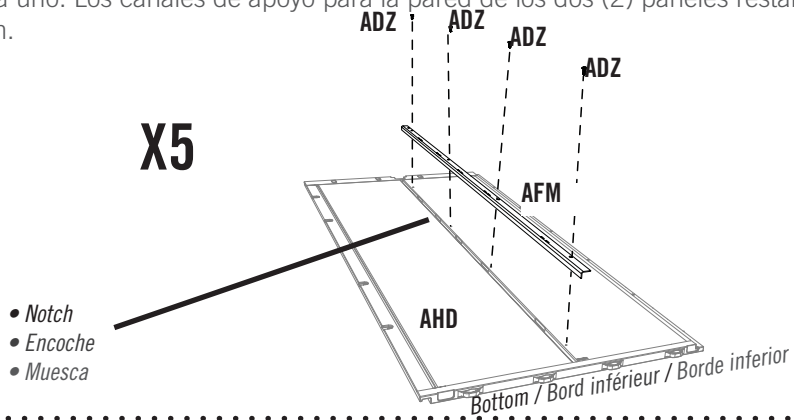

- Notch
- Encoche
- Muesca

7.3

- Insert the two left-most tabs at the bottom of the **Corner Panel (AGY)** into the two right-most slots along the front edge of the Floor.
- Insérer les deux languettes gauches au fond du **panneau angulaire (AGY)** dans les deux rainures droites le long du bord du plancher.
- Insertar las lengüetas al borde inferior del **panel angular (AGY)** en las ranuras a lo largo del borde del piso.

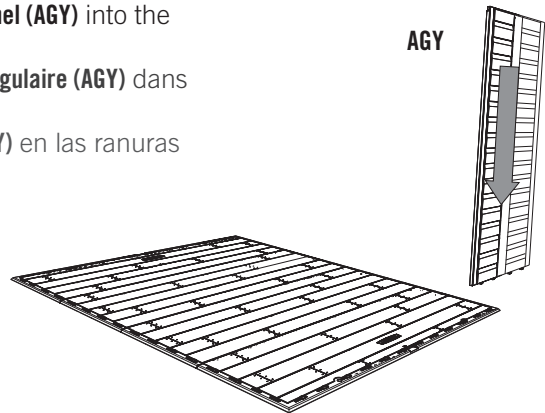

7.4

- Slide the panel to the left.
- Faire glisser le panneau à gauche.
- Deslizar el panel a la izquierda.

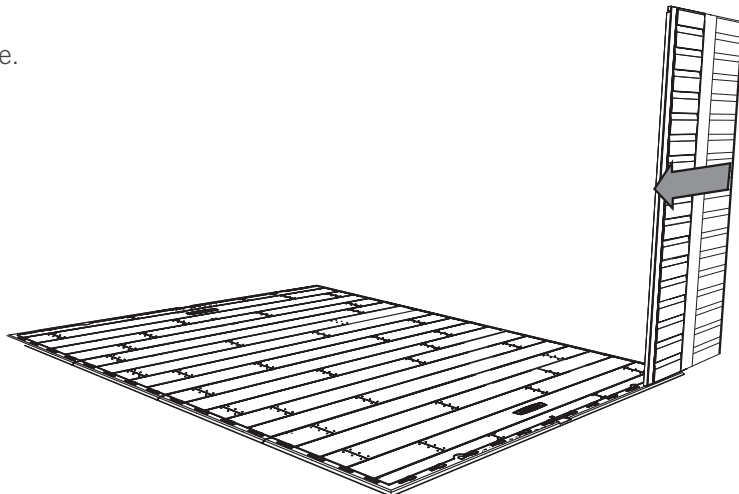

► SECTION 7 (CONTINUED) / SECTION 7 (SUITE) / SECCIÓN 7 (CONTINUACIÓN)

TOOLS AND HARDWARE REQUIRED / OUTILS ET QUINCAILLERIE REQUIS / INSTRUMENTAL Y HERRAJE REQUERIDOS



AIW (x1)

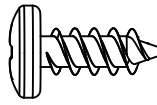

ADZ (x15)

7.5

- Bend the corner panel, and pull down on the panel to snap the remaining tabs in place. To help with insertion, place the **block (AIW)** under the floor panel directly under the tab being inserted. You should hear a “click” when the tab pops into place. **Repeat this step for the second tab.**
- Plier le panneau angulaire, et insérer les autres languettes. Pour aider avec le montage, mettre le **bloque (AIW)** sous le panneau de plancher directement sous la languette à insérer. **Répéter ce processus pour la deuxième languette.**
- Doblar el panel angular e introduzca las lengüetas restantes. Para ayudar con el armado, deslizar el **bloque (AIW)** debajo el panel de piso directamente debajo la lengüeta a insertar. Se escucha un «clic» cuando la lengüeta se sienta en su lugar. **Repetir este proceso para la segunda lengüeta.**

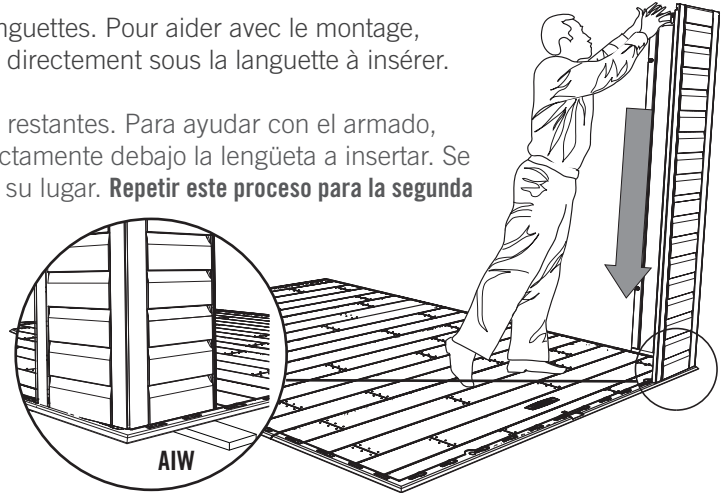

7.6

- One at a time, insert the four tabs at the bottom of the **wall panels (AHD)** or **window wall panel (AHH)** into the next four slots along the edge of the floor, and slide the panels forward. **Insert the window wall panel on either side of the shed. You may need to use a rubber mallet and the block to gently tap the panel forward.** Attach the panels together with five (5) screws (ADZ).
- Un par un, insérer les quatre languettes au fond du **panneau mural (AHD)** ou du **panneau mural pour la fenêtre (AHH)** dans les quatre rainures suivantes le long du bord du plancher, et faire glisser les panneaux vers le bord avant. **Insérer le panneau mural pour la fenêtre soit le côté droit soit le côté gauche de l'abri. Si besoin, utiliser un maillet en caoutchouc et le bloc pour mettre en place les panneaux.** Attacher les panneaux l'un à l'autre à l'aide de cinq (5) vis (ADZ).
- Uno por uno, insertar las cuatro lengüetas al borde inferior del **panel mural (AHD)** o **panel mural para la ventana (AHH)** en las cuatro ranuras siguientes a lo largo del borde del piso, y deslizar los paneles hacia el borde delantero. **Insertar el panel mural para la ventana en cualquiera de los dos lados de la caseta. Si es necesario, usar un mazo de goma y el bloque para dar un golpecito al panel para ubicar cuidadosamente el panel en su lugar.** Sujetar los paneles los unos a los otros usando cinco (5) tornillos (ADZ).

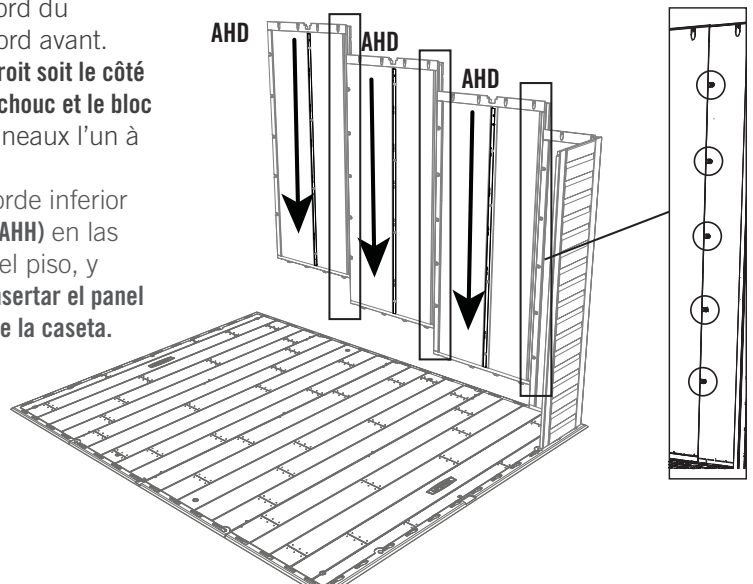

► SECTION 7 (CONTINUED) / SECTION 7 (SUITE) / SECCIÓN 7 (CONTINUACIÓN)

TOOLS AND HARDWARE REQUIRED / OUTILS ET QUINCAILLERIE REQUIS / INSTRUMENTAL Y HERRAJE REQUERIDOS



AIW (x1)

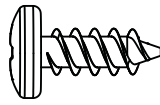

ADZ (x35)

7.7

- Insert this **corner wall panel (AGW)** in the same way as the first one.
- Insérer le **panneau angulaire (AGW)** de la même manière que le premier panneau angulaire.
- Insertar este **panel angular (AGW)** en la misma manera que el primer panel angular.

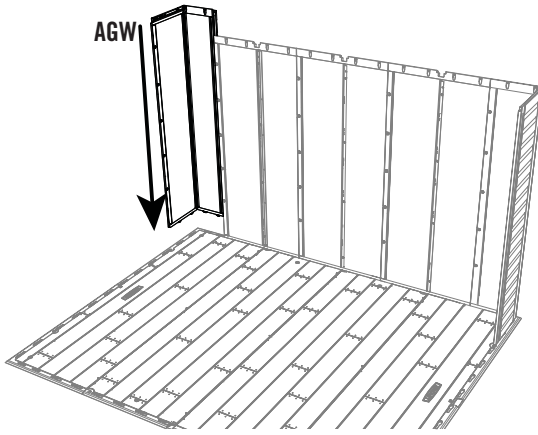

7.8

- Insert these **wall panels (AHD)** in the same way as the previous ones. **Do not place window wall panels along the rear of the shed.**
- Insérer ces **panneaux muraux (AHD)** de la même manière que les panneaux précédents. **Ne pas insérer les deux panneaux muraux pour la fenêtre le long de bord arrière de l'abri.**
- Insertar estos **paneles murales (AHD)** en la misma manera que los paneles anteriores. **No insertar los paneles murales para la ventana a lo largo del borde trasero de la caseta.**

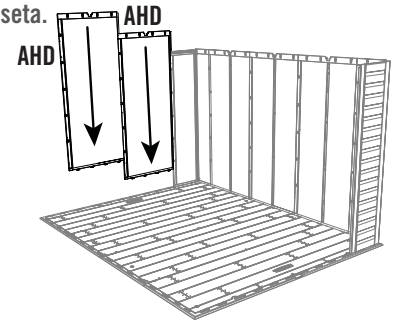

7.9

- Insert this **corner wall panel (AGL)** in the same way as the first one.
- Insérer le **panneau angulaire (AGL)** de la même manière que le premier panneau angulaire.
- Insertar este **panel angular (AGL)** en la misma manera que el primer panel angular.

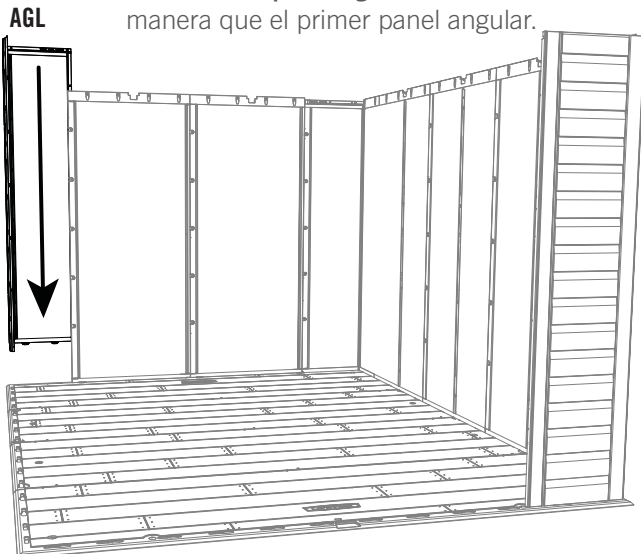

7.10

- Insert these wall panels in the same way as the other side. **The window wall panel may be inserted on either side of the shed.**
- Insérer ces panneaux muraux de la même manière que ceux de l'autre côté. **Le panneau mural pour la fenêtre s'insère soit le côté droit soit le côté gauche de l'abri.**
- Insertar estos paneles murales en la misma manera que los del otro lado. **Se puede insertar el panel mural para la ventana en cualquiera de los dos lados de la caseta.**

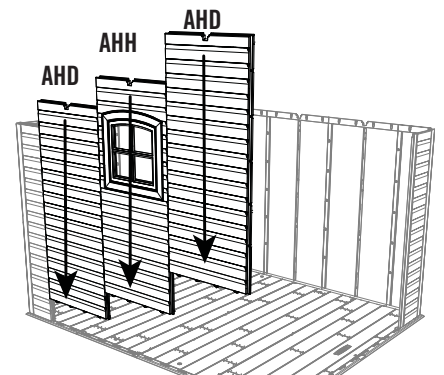

► SECTION 7 (CONTINUED) / SECTION 7 (SUITE) / SECCIÓN 7 (CONTINUACIÓN)

TOOLS AND HARDWARE REQUIRED / OUTILS ET QUINCAILLERIE REQUIS / INSTRUMENTAL Y HERRAJE REQUERIDOS



AIW (x1)

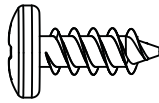

ADZ (x5)

7.11

- Insert this **corner wall panel (AGN)** in the same way as the first one.
- Insérer le **panneau angulaire (AGN)** dans la même manière que le premier panneau angulaire.
- Insertar este **panel angular (AGN)** en la misma manera que el primer panel angular.

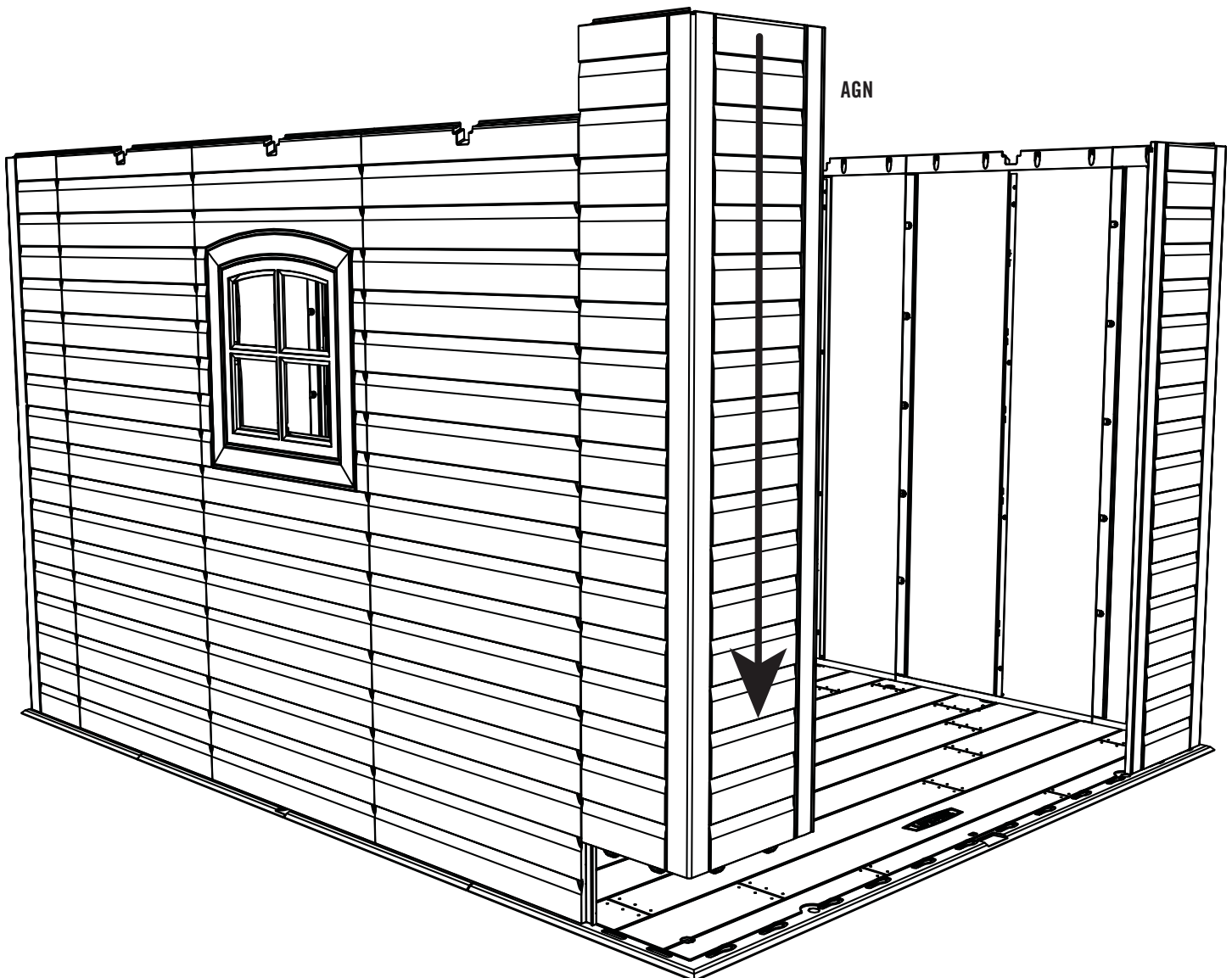



PARTS IDENTIFIER / IDENTIFICADOR DE PIEZAS / IDENTIFICATEUR DE PIÈCES

CONTENTS OF BOX 1 / CONTENIDO DE LA CAJA 1 / CONTENU DE LA BOÎTE 1

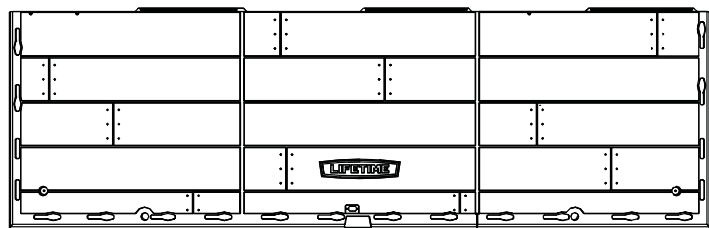

CUW (x2)

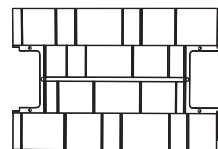

AFY (x3)

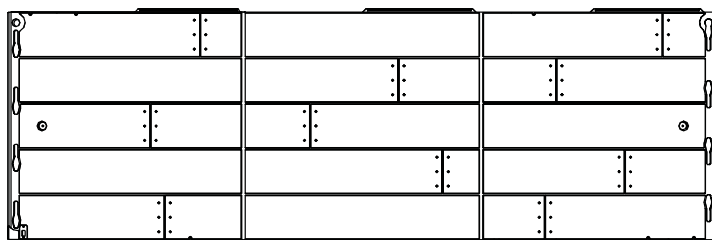

CUD (x2)

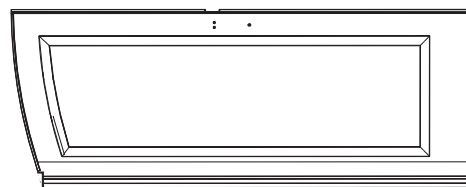

BDJ (x1)

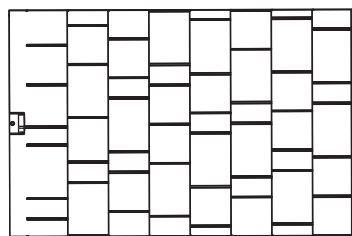

AGQ (x8)

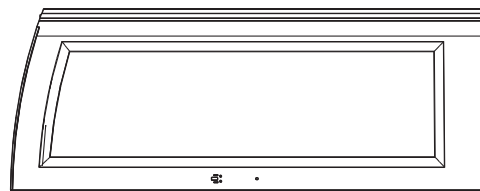

BDK (x1)

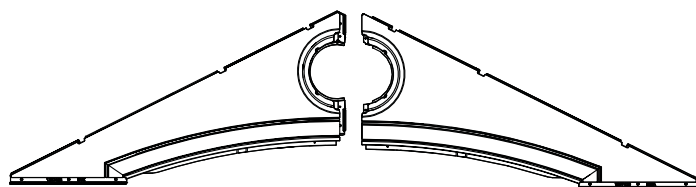

EVZ (x1)

EWA (x1)

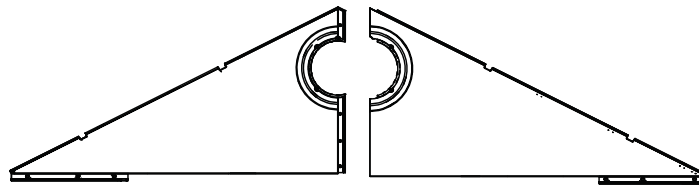

AGI (x1)

AGH (x1)

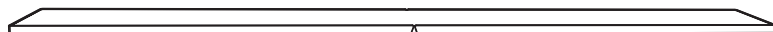

AFV (x1)

Remove this section for quick reference / Enlever cette section pour référence rapide / Retirar esta sección para referencia rápida



PARTS IDENTIFIER / IDENTIFICADOR DE PIEZAS / IDENTIFICATEUR DE PIÈCES

CONTENTS OF METAL KIT / CONTENIDO DEL KIT DE PIEZAS DE METAL / CONTENU DU KIT PIÈCES EN MÉTAL

Remove this section for quick reference / Enlever cette section pour référence rapide / Retirar esta sección para referencia rápida

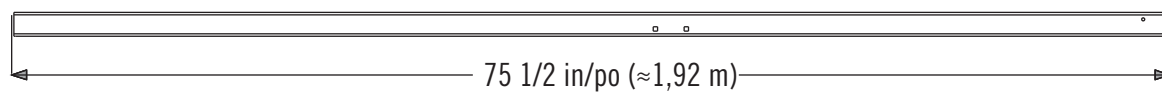

AFC (x2)

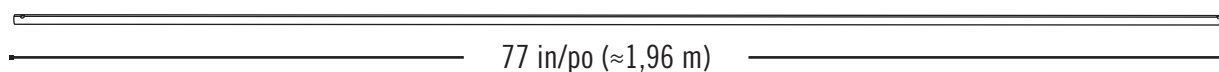
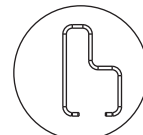

CRD (x2)

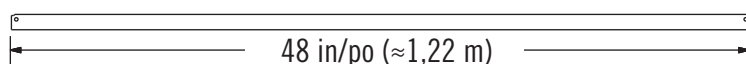

AFG (x3)

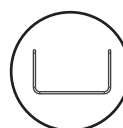

DSR (x6)

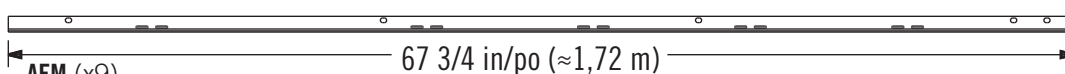

AFM (x9)

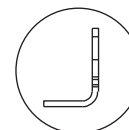

EYS (x1)



HDU (x1)



HDT (x1)



PARTS IDENTIFIER / IDENTIFICADOR DE PIEZAS / IDENTIFICATEUR DE PIÈCES

CONTENTS OF BOX 2 / CONTENIDO DE LA CAJA 2 / CONTENU DE LA BOÎTE 2

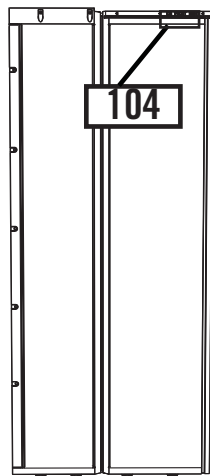

AGY (x1)

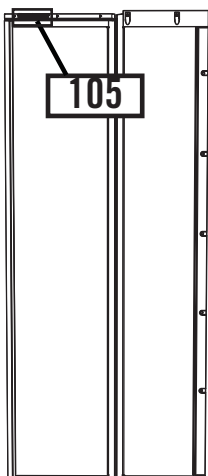

AGN (x1)

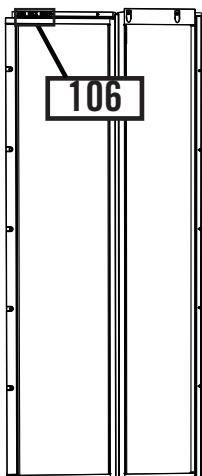

AGW (x1)

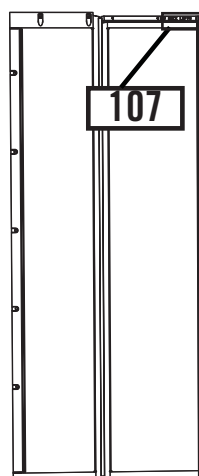

AGL (x1)

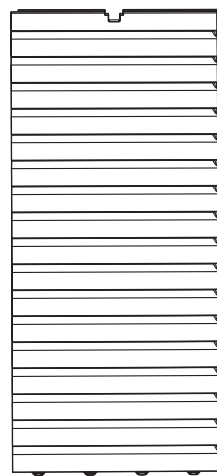

AHD (x7)



AHH (x1)

CONTENTS SMALL PARTS BOX / CONTENIDO DE LA CAJA DE PIEZAS PEQUEÑAS / CONTENU DE LA BOÎTE DE PIÈCES EN MÉTAL

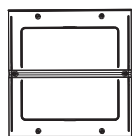

AHC (x4)

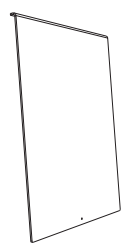

AHE (x1)

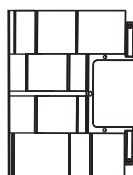

AGG (x1)

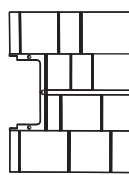

AFW (x1)



AIW (x1)

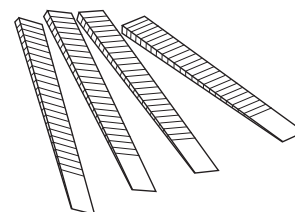

AIX (x4)

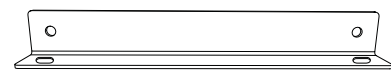

HDV (x2)



AFL (x8)



Remove this section for quick reference / Enlever cette section pour référence rapide / Retirar esta sección para referencia rápida



Remove this section for quick reference / Enlever cette section pour référence rapide / Retirar esta sección para referencia rápida

*THIS PAGE INTENTIONALLY LEFT BLANK
CETTE LPAGE A ÉTÉ INTENTIONNELLEMENT LAISSÉE EN BLANC
ESTA PÁGINA SE HA DEJADO EN BLANCO INTENCIONADAMENTE*



HARDWARE REQUIRED / QUINCAILLERIE REQUISE / HERRAJE REQUERIDO

Hardware Bag / Sac de quincaillerie / Bolsa de herraje

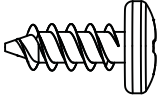

ADZ (x16)



AIY (x2)

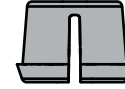

FEX (x4)

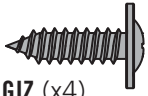

GJZ (x4)



PARTS REQUIRED / PIÈCES REQUISES / PIEZAS REQUERIDAS

Metal Parts / Pièces en métal / Piezas de metal

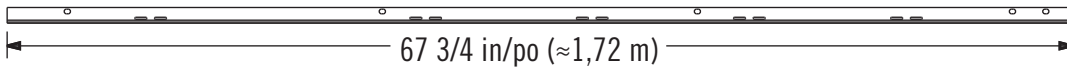

AFM (x2)

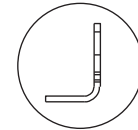

HDU (x1)

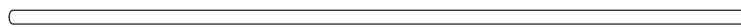

HDT (x1)

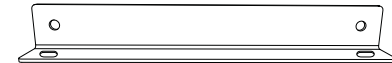

HDV (x2)

Plastic Parts / Pièces en plastique / Piezas de plástico

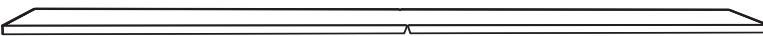

AFV (x1)



TOOLS REQUIRED (NOT INCLUDED—UNLESS INDICATED OTHERWISE*) / OUTILS REQUIS (NON INCLUS — SAUF INDICATION CONTRAIRE*) / INSTRUMENTAL REQUERIDO (NO INCLUIDO, SALVO INDICACIÓN CONTRARIA*)



► SECTION 8 (CONTINUED) / SECTION 8 (SUITE) / SECCIÓN 8 (CONTINUACIÓN)

TOOLS AND PARTS REQUIRED / OUTILS ET QUINCAILLERIE REQUIS / INSTRUMENTAL Y HERRAJE REQUERIDOS

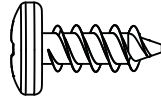

ADZ (x8)



- In case of any trouble with this section, scan the QR code below to view a video on its assembly.
- En cas de problème avec cette section, scanner le QR code en dessous pour voir une vidéo de l'assemblage.
- En caso de problemas con esta sección, escanear el código QR debajo para ver un video del ensamblaje.



<http://go.Lifetime.com/8x10storagehed-section8>

8.1

- The right **wall/shelf support channel (AFM)** goes in the slot directly under the notch in the wall panel. The left wall support channel goes in the slot to the right of the notch in the wall panel.
- Le **canal de support du mur/étagère (AFM)** droit s'attache dans la rainure directement sous l'encoche dans le panneau mural. Le canal de support du mur/étagère gauche s'attache dans la rainure à la droite de l'encoche du panneau mural.
- El **canal de soporte para la pared/estante (AFM)** derecho se sujeta dentro de la ranura directamente debajo la muesca en el panel de pared. El canal de soporte para la pared izquierdo se sujeta dentro de la ranura a la derecha de la muesca en el panel de pared.

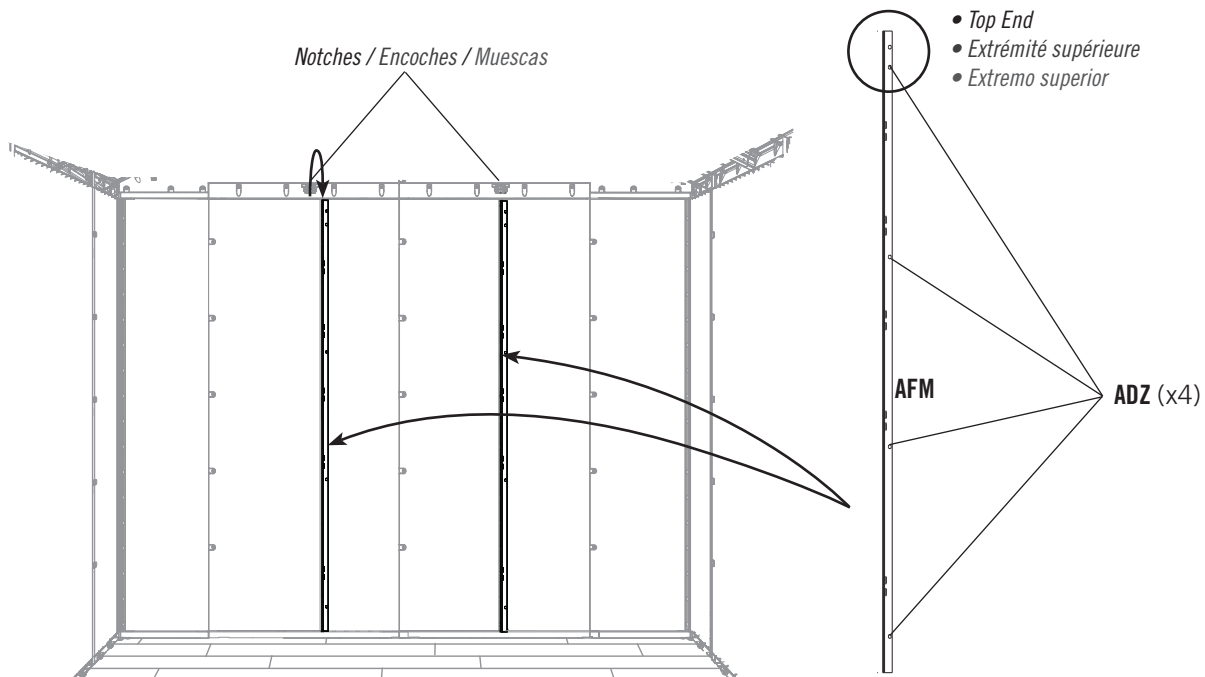

► SECTION 8 (CONTINUED) / SECTION 8 (SUITE) / SECCIÓN 8 (CONTINUACIÓN)

TOOLS AND PARTS REQUIRED / OUTILS ET QUINCAILLERIE REQUIS / INSTRUMENTAL Y HERRAJE REQUERIDOS



AIY (x2)

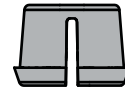

FEX (x4)

8.2

- Insert the **shelf brackets (AIY)** into the slots in the wall/shelf support channels. **The brackets must be at the same height.**
- Insérer les **équerres (AIY)** dans les fentes dans les canaux de support pour les murs/étagères. **Les équerres doivent être à la même hauteur.**
- Insertar las **escuadras (AIY)** en las ranuras en los canales de soporte para las paredes/estantes. **Las escuadras deben estar a la misma altura.**

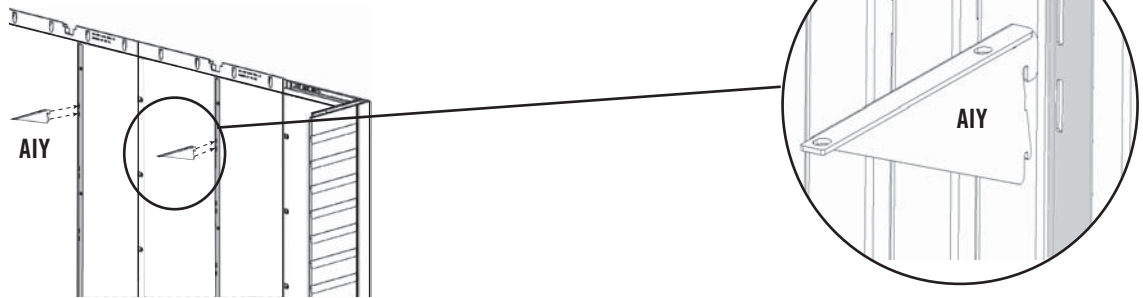

8.3

- Place **screw anchors (FEX)** into the side walls at the same level the shelf braces were placed.
- Placez les vis **d'ancrage (FEX)** dans les murs de côté à la même hauteur que vous avez placé les renforts de l'étagère.
- Coloque los **anclajes de tornillo (FEX)** en las paredes laterales al mismo nivel en el que se colocaron los soportes del estante.

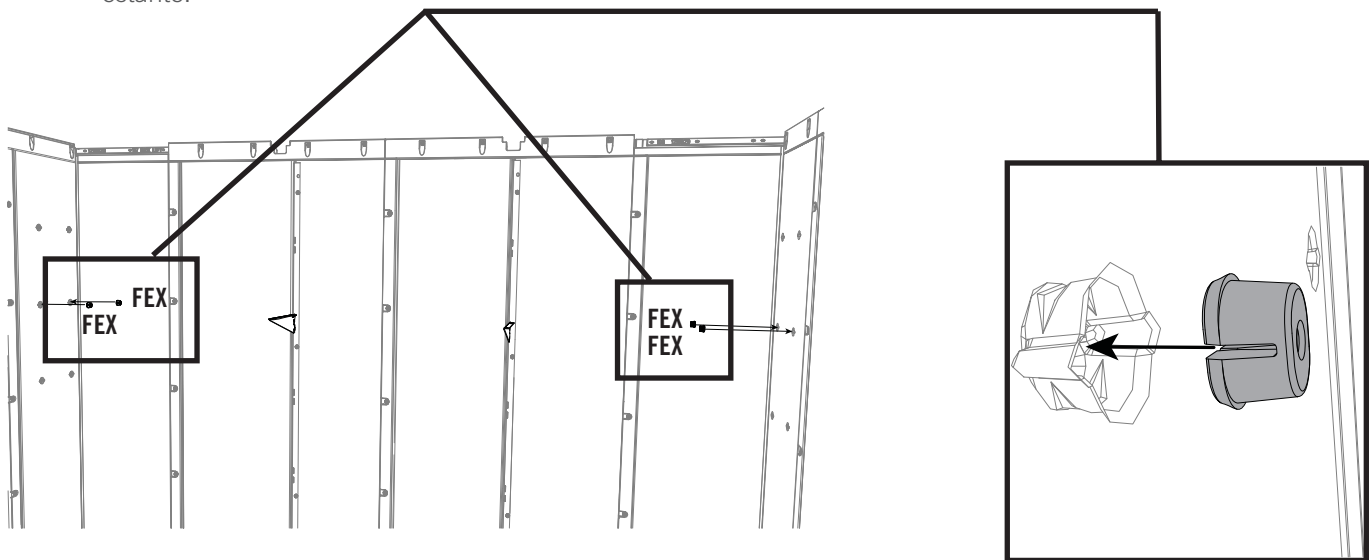

► SECTION 8 (CONTINUED) / SECTION 8 (SUITE) / SECCIÓN 8 (CONTINUACIÓN)

TOOLS AND PARTS REQUIRED / OUTILS ET QUINCAILLERIE REQUIS / INSTRUMENTAL Y HERRAJE REQUERIDOS

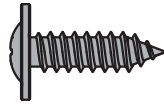

GJZ (x4)

8.4

- Attach a **shelf support bracket (HDV)** into the side wall at the same level the shelf braces were placed. Repeat for the other shelf support bracket on the opposite side.
- Placez le **support de l'étagère (HDV)** dans le mur de côté à la même hauteur que vous avez placé les renforts de l'étagère. Répétez pour le support de l'étagère de l'autre côté.
- Fije un **soporte de estante (HDV)** en la pared lateral al mismo nivel en el que se colocaron los soportes del estante. Repita para el otro soporte de estante en el lado opuesto.

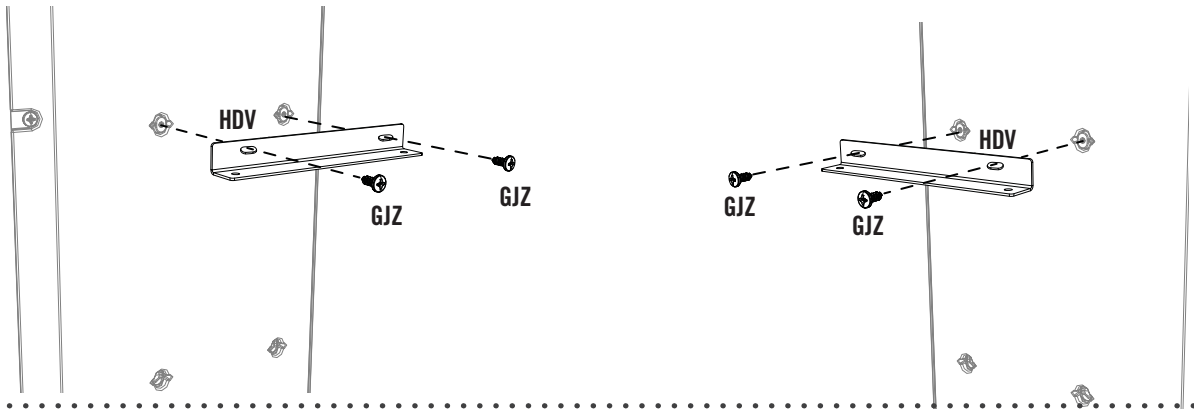

8.5

- *Unfold the shelf before installing.*
- *Unfold the shelf before installing.*
- *Unfold the shelf before installing.*

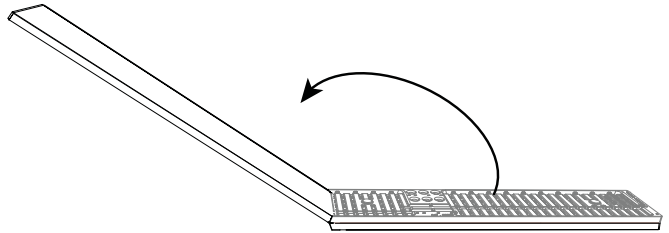

8.6

- Snap the **short and long shelf support tubes (HDT and HDU)** into the underside of the shelf. The long shelf support tube should be put in place near the side labelled "Front".
- Clipsez les **tubes d'appui long et court de l'étagère (HDT et HDU)** sous l'étagère. Le tube d'appui long doit être mis en place près du côté marqué « Devant ».
- Conecte a presión los **tubos de soporte del estante corto y largo (HDT y HDU)** en la parte inferior del estante. El tubo de soporte largo del estante debería ponerse en su lugar cerca del lado etiquetado "Front".

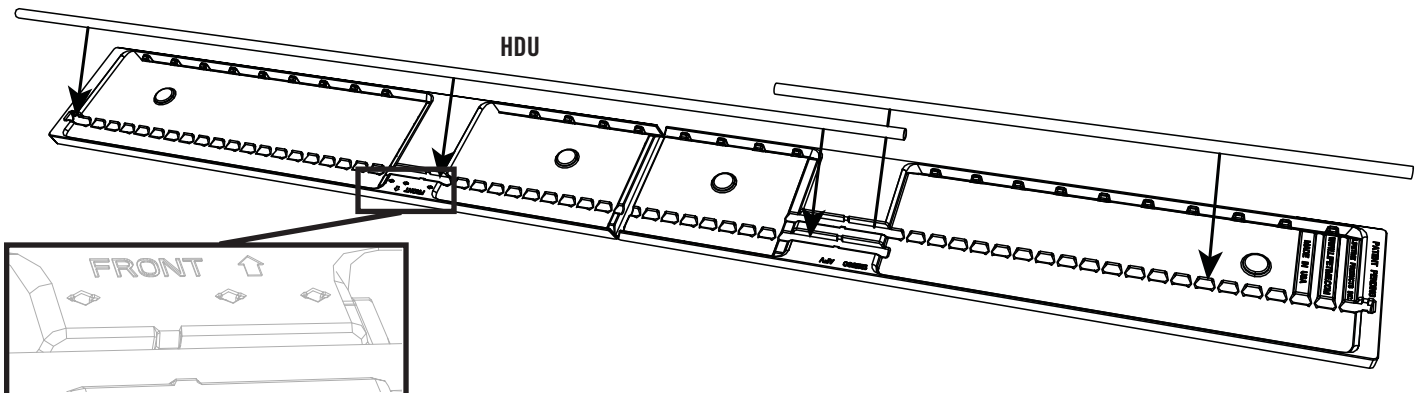

► SECTION 8 (CONTINUED) / SECTION 8 (SUITE) / SECCIÓN 8 (CONTINUACIÓN)

TOOLS AND PARTS REQUIRED / OUTILS ET QUINCAILLERIE REQUIS / INSTRUMENTAL Y HERRAJE REQUERIDOS

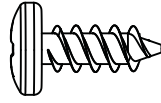

ADZ (x8)

8.7

- Attach the **shelf (AFV)** to the corner wall panels and shelf support brackets using eight (8) **screws (ADZ)**.
- Attachez l'**étagère (AFV)** aux panneaux de mur de coin et aux supports de l'étagère à l'aide de huit (8) **vis (ADZ)**.
- Fije el **estante (AFV)** a los paneles de pared de esquina y a los soportes del estante usando ocho (8) **tornillos (ADZ)**.

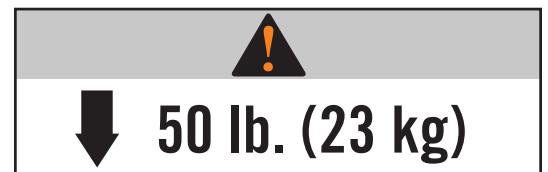
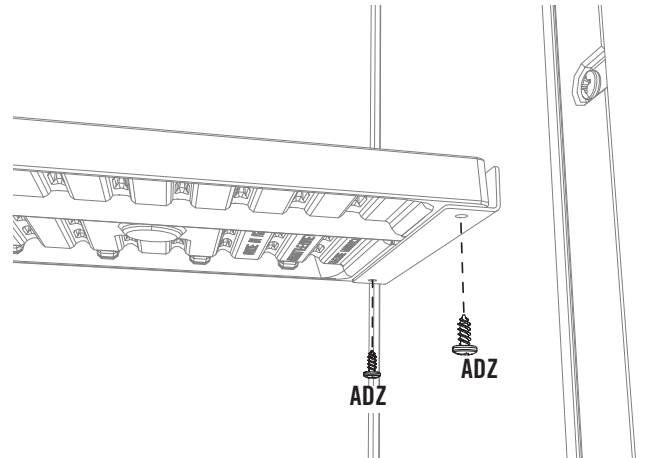
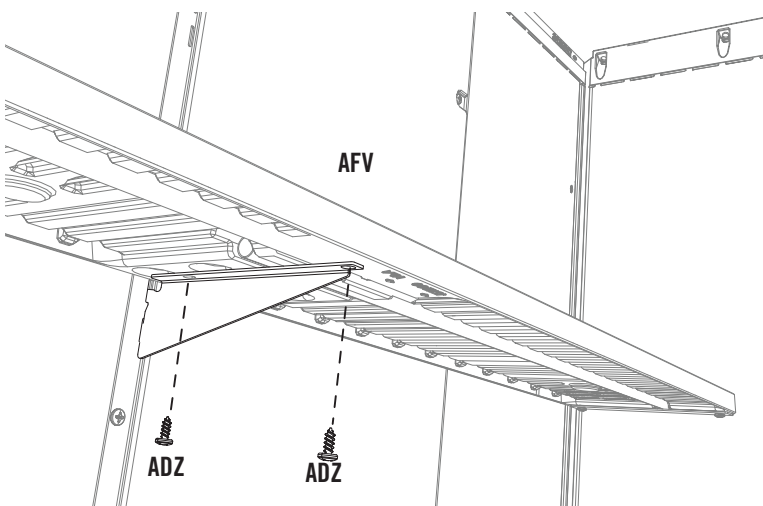
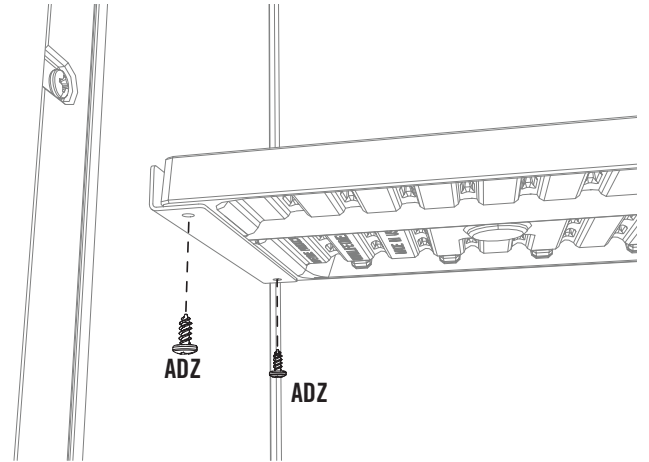
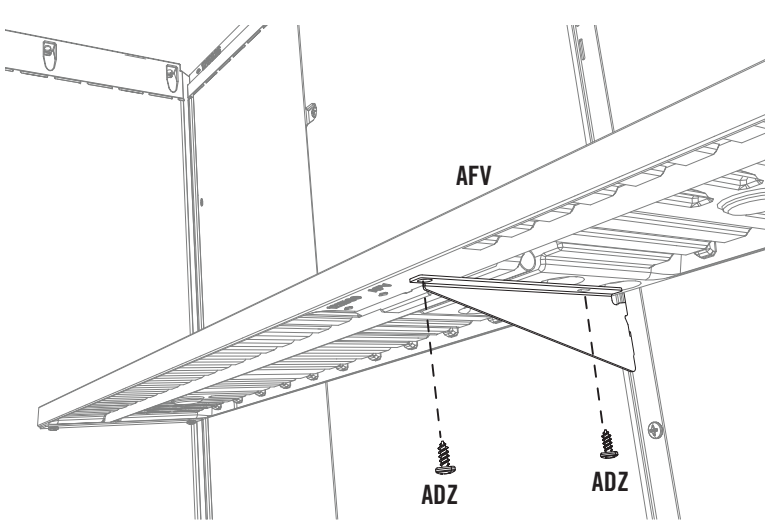

9

DOOR & ENTRY GABLE INSTALLATION / INSTALLATION DU PIGNON D'ENTRÉE ET DES PORTES / INSTALACIÓN DE LA FACHADA DE ENTRADA Y LAS PUERTAS



HARDWARE REQUIRED / QUINCAILLERIE REQUISE / HERRAJE REQUERIDO

Hardware Bag / Sac de quincaillerie / Bolsa de herraje

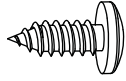

ADX (x4)



AHP (x2)

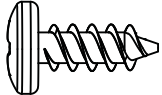

ADZ (x6)

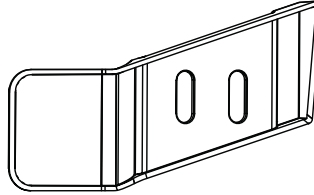

AIM (x1)

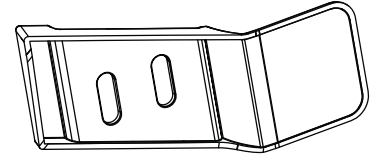

AIC (x1)



PARTS REQUIRED / PIÈCES REQUISES / PIEZAS REQUERIDAS

Plastic Parts / Pièces en plastique / Piezas de plástico

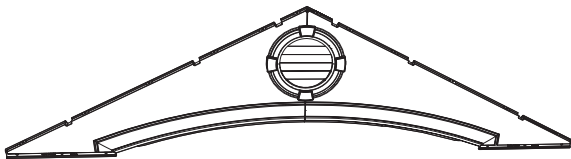

(x1)

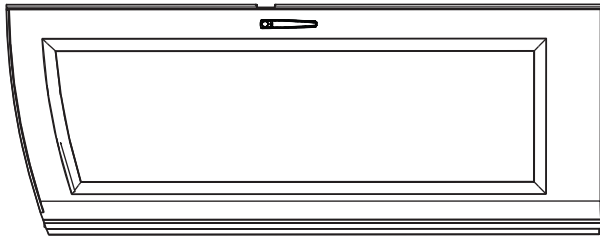

(x1)

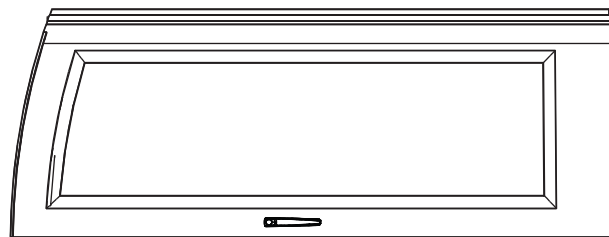

(x1)



TOOLS REQUIRED (NOT INCLUDED—UNLESS INDICATED OTHERWISE*) / OUTILS REQUIS (NON INCLUS — SAUF
INDICATION CONTRAIRE*) / INSTRUMENTAL REQUERIDO (NO INCLUIDO, SALVO INDICACIÓN CONTRARIA*)

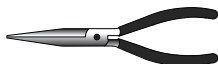

► SECTION 9 (CONTINUED) / SECTION 9 (SUITE) / SECCIÓN 9 (CONTINUACIÓN)

TOOLS AND HARDWARE REQUIRED / OUTILS ET QUINCAILLERIE REQUIS / INSTRUMENTAL Y HERRAJE REQUERIDOS



AHP (x2)



- In case of any trouble with this section, scan the QR code below to view a video on its assembly.
- En cas de problème avec cette section, scanner le QR code en dessous pour voir une vidéo de l'assemblage.
- En caso de problemas con esta sección, escanear el código QR debajo para ver un video del ensamblaje.

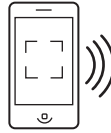

<http://go.Lifetime.com/8x10storageshed-section9>

9.1



- Pull the hinge tube down out of the door about six inches. Align the hole at the bottom of the hinge tube with the slit in the bushing, and insert the tube. Insert a **cotter pin (AHP)** and bend the ends.
- Étendre le tube d'articulation à peu près quinze centimètres du bord inférieur de la porte. Aligner le trou dans la partie inférieure du tube avec la fente dans la bague, et insérer le tube. Insérer une **clavette (AHP)** et plier les extrémités.
- Extender el tubo de articulación unos quince centímetros del borde inferior de la puerta. Alinear el agujero en la parte inferior del tubo con la rendija en el casquillo, e insertar el tubo. Insertar una **clavija (AHP)** y doblar los extremos.

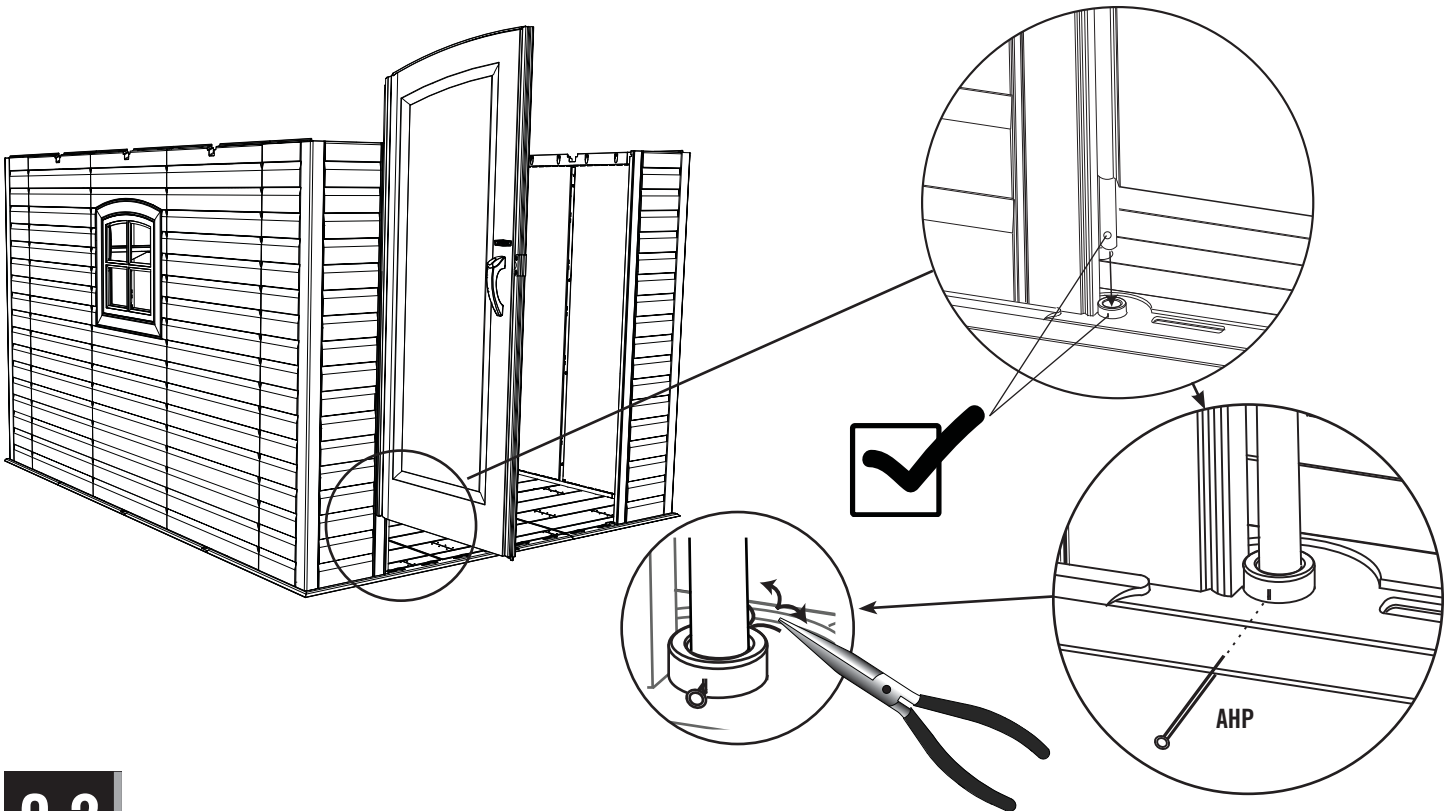

9.2

- Repeat the previous step for the right door.
- Répéter l'étape précédente pour la porte droite.
- Repetir el paso anterior para la puerta derecha.

► SECTION 9 (CONTINUED) / SECTION 9 (SUITE) / SECCIÓN 9 (CONTINUACIÓN)

TOOLS AND HARDWARE REQUIRED / OUTILS ET QUINCAILLERIE REQUIS / INSTRUMENTAL Y HERRAJE REQUERIDOS

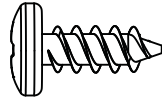

ADZ (x6)

9.3

- Slide the holes in the entry gable down over the two hinge tubes.
- Faire glisser les trous dans le toit à pignon d'entrée sur les deux tubes.
- Deslizar los agujeros en la fachada de entrada sobre los dos tubos.

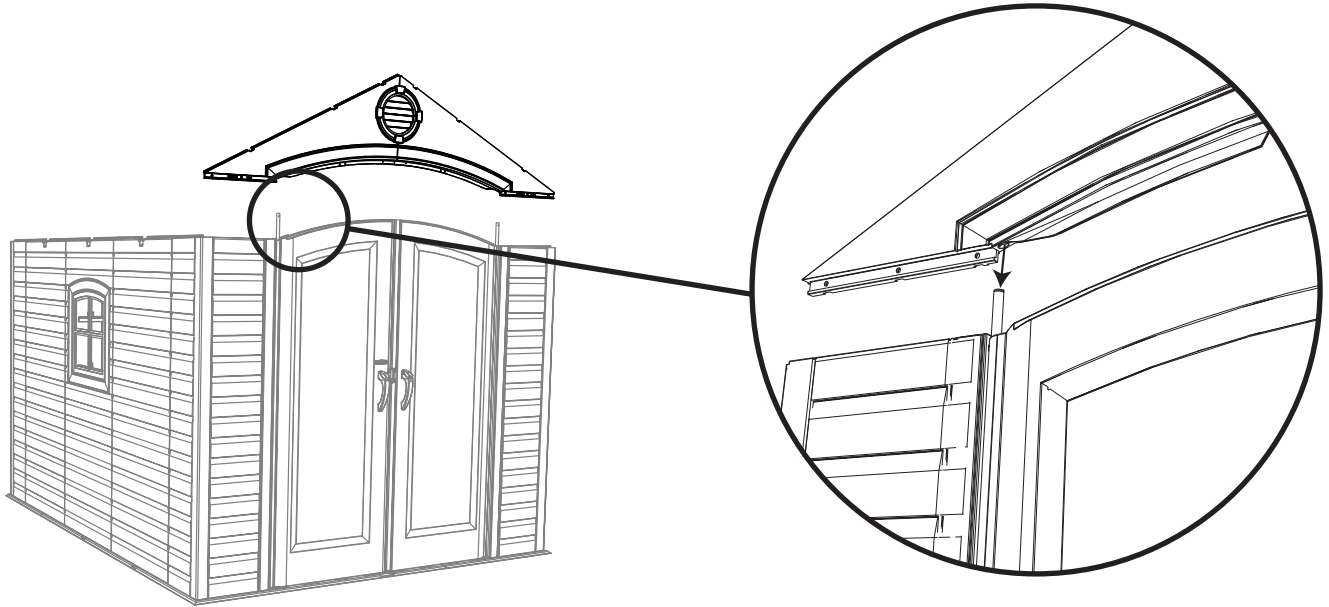

9.4

- Secure the entry gable to the shed using six (6) **screws (ADZ)**.
- Attacher le toit à pignon d'entrée à l'abri à l'aide de six (6) **vis (ADZ)**.
- Sujetar la fachada de entrada a la caseta usando seis (6) **tornillos (ADZ)**.

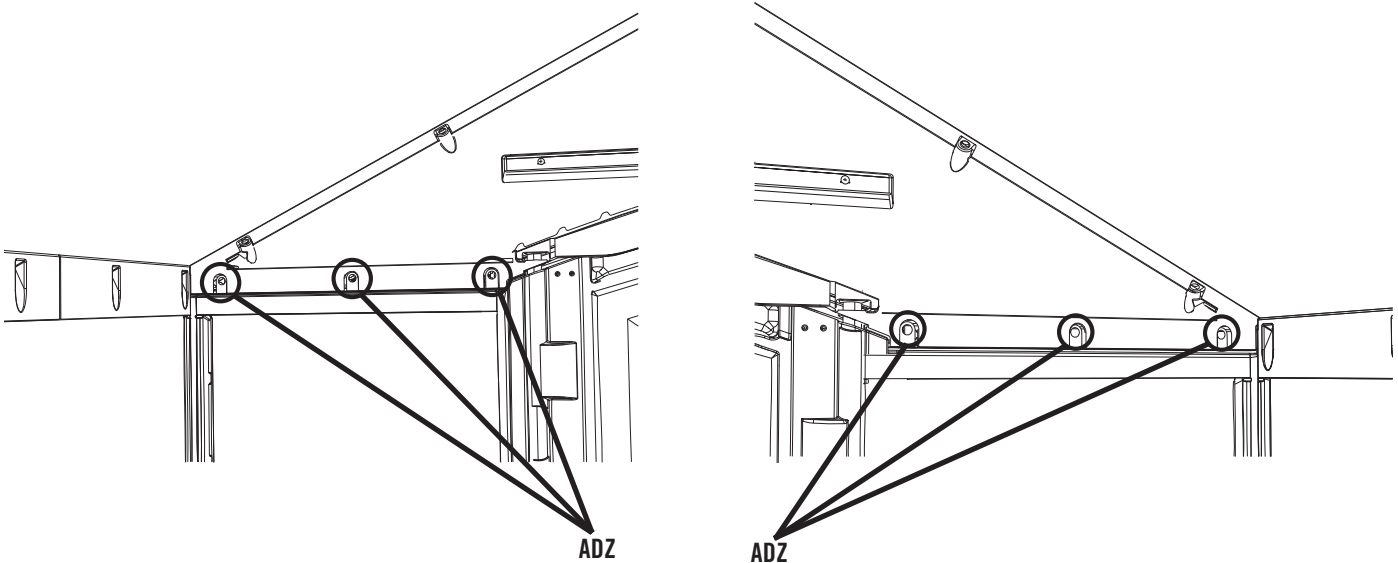

► SECTION 9 (CONTINUED) / SECTION 9 (SUITE) / SECCIÓN 9 (CONTINUACIÓN)

TOOLS AND HARDWARE REQUIRED / OUTILS ET QUINCAILLERIE REQUIS / INSTRUMENTAL Y HERRAJE REQUERIDOS

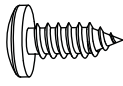

ADX (x4)

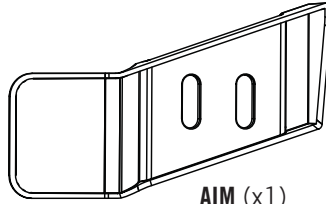

AIM (x1)

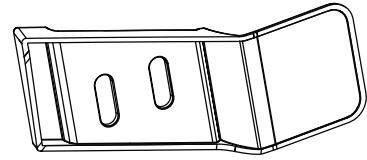

AIC (x1)

9.5

- Attach the **left (AIC)** and **right (AIM)** gap flaps to the corners of the doors using the hardware included. **These flaps simply serve to block out light.**
- Attacher les **rabats gauche (AIC)** et **droit (AIM)** aux portes à l'aide de la quincaillerie incluse. **Ces rabats ne servent que pour empêcher la lumière d'entrer.**
- Sujeter las **tapas de las puertas izquierda (AIC)** y **derecha (AIM)** a las puertas usando el herraje incluido. **Estas tapas sirven sólo para tapar la luz.**

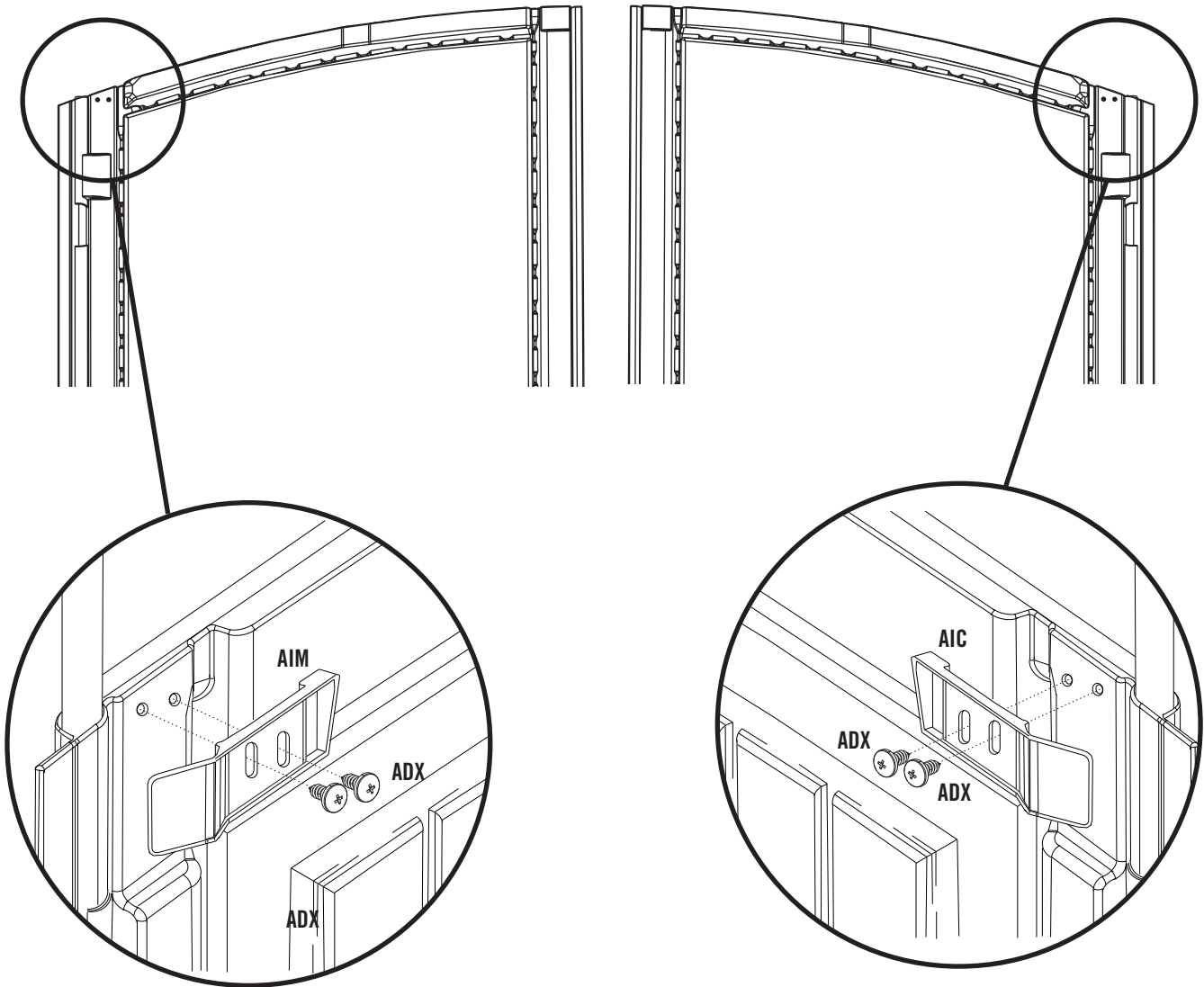

10

ROOF ASSEMBLY / ASSEMBLAGE DU TOIT / ENSAMBLE DEL TEJADO



HARDWARE REQUIRED / QUINCAILLERIE REQUISE / HERRAJE REQUERIDO

Hardware Bag / Sac de quincaillerie / Bolsa de herraje

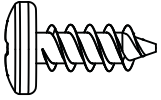

ADZ (x126)

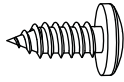

ADX (x24)

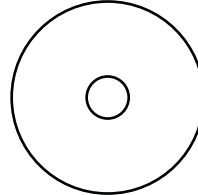

AED (x24)

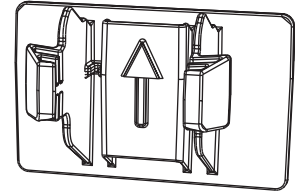

AXX (x2)



PARTS REQUIRED / PIÈCES REQUISES / PIEZAS REQUERIDAS

Metal Parts / Pièces en métal / Piezas de metal



AFL (x8)

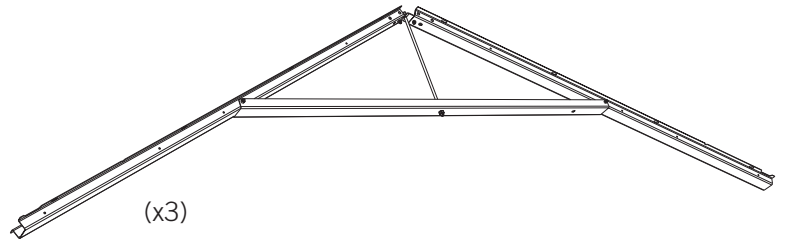

Plastic Part / Pièce en plastique / Piezas de plástico

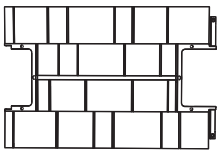

AFY (x3)

Plastic Part / Pièce en plastique / Piezas de plástico

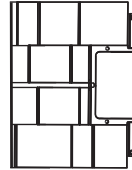

AGG (x1)

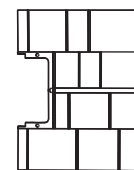

AFW (x1)

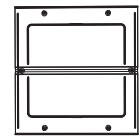

AHC (x4)

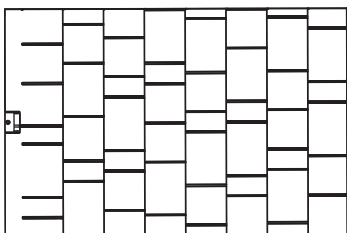

AGQ (x8)

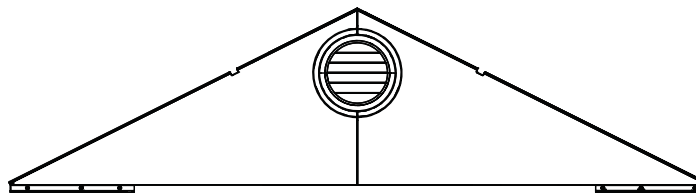

TOOLS REQUIRED (NOT INCLUDED—UNLESS INDICATED OTHERWISE*) / OUTILS REQUIS (NON INCLUS — SAUF INDICATION CONTRAIRE*) / INSTRUMENTAL REQUERIDO (NO INCLUIDO, SALVO INDICACIÓN CONTRARIA*)



► SECTION 10 (CONTINUED) / SECTION 10 (SUITE) / SECCIÓN 10 (CONTINUACIÓN)

TOOLS AND HARDWARE REQUIRED / OUTILS ET QUINCAILLERIE REQUIS / INSTRUMENTAL Y HERRAJE REQUERIDOS



- In case of any trouble with this section, scan the QR code below to view a video on its assembly.
- En cas de problème avec cette section, scanner le QR code en dessous pour voir une vidéo de l'assemblage.
- En caso de problemas con esta sección, escanear el código QR debajo para ver un video del ensamblaje.



<http://go.Lifetime.com/8x10storageshed-section10>

10.1

- Set a truss assembly into the notches on the first two opposite wall panels. Set a **roof panel (AGQ)** onto the gable, wall panel, and truss assembly.
- Mettre une ferme dans les encoches des premiers deux panneaux muraux opposés. Mettre un **panneaux de toit (AGQ)** sur le pignon, panneau mural, et la ferme.
- Colocar una cercha dentro de las muescas de los primeros dos paneles de pared opuestos. Colocar un **panel de tejado (AGQ)** sobre la fachada de entrada, panel mural, y la cercha.

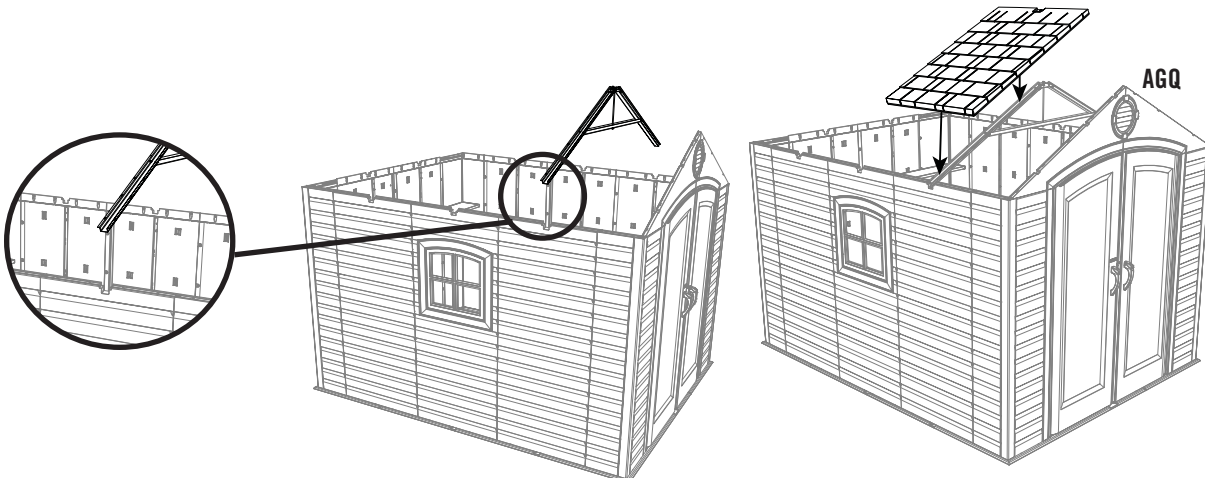

► SECTION 10 (CONTINUED) / SECTION 10 (SUITE) / SECCIÓN 10 (CONTINUACIÓN)

TOOLS AND HARDWARE REQUIRED / OUTILS ET QUINCAILLERIE REQUIS / INSTRUMENTAL Y HERRAJE REQUERIDOS

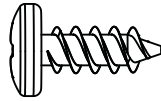

ADZ (x4)

10.2

- Set the **roof panel (AGQ)** down onto the wall panel, gable, and truss. The groove at the bottom of the roof panel sets over the top of the wall panel. Ensure the alignment nub fits into the notch in the truss.
- Mettre le **panneau de toit (AGQ)** dans le panneau mural, le pignon, et la ferme. Mettre la rainure au bord inférieur du panneau de toit sur la partie supérieure du panneau mural. Mettre la petite bosse d'alignement dans l'encoche de la ferme.
- Colocar el **panel de tejado (AGQ)** en el panel de pared, la fachada, y la cercha. Colocar la ranura a lo largo del borde inferior del panel de tejado sobre la parte superior del panel de pared. Encajar el bulto de alineamiento en la muesca en la cercha.

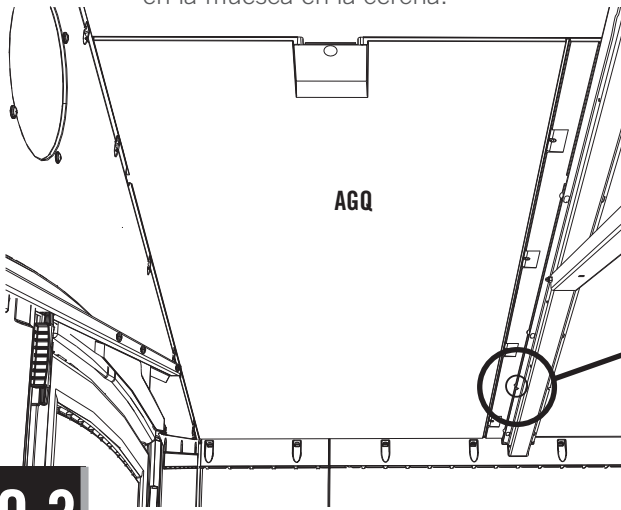

- Notch
- Encoche
- Muesca

- Alignment nub
- Bosse d'alignement
- Bulto de alineamiento

10.3

- Align the four holes in the wall panel with those at the bottom of the roof panel, and insert four (4) **screws (ADZ)** to secure the panel in place.
- Aligner les quatre trous dans le panneau mural avec ceux au bord inférieur du panneau de toit, et insérer quatre (4) **vis (ADZ)** pour attacher le panneau en place.
- Alinear los cuatro agujeros en el panel de pared con los al borde inferior del panel de tejado, e insertar cuatro (4) **tornillos (ADZ)** para sujetarlo en su lugar.

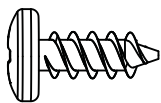
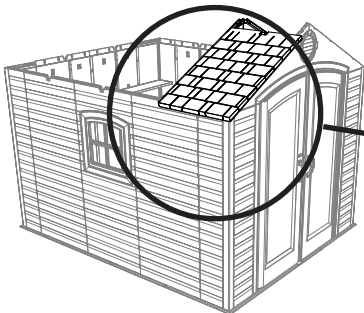

ADZ (x4)

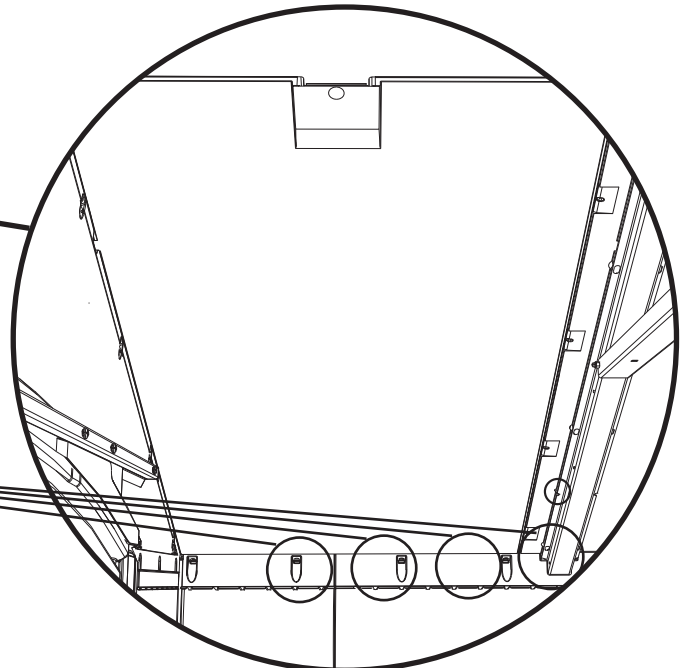

► SECTION 10 (CONTINUED) / SECTION 10 (SUITE) / SECCIÓN 10 (CONTINUACIÓN)

TOOLS AND HARDWARE REQUIRED / OUTILS ET QUINCAILLERIE REQUIS / INSTRUMENTAL Y HERRAJE REQUERIDOS

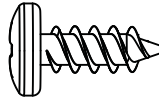

ADZ (x4)

10.4

- Insert the first two **screws (ADZ)** through the gable and into the roof panel and the first two **screws (ADZ)** through the truss and the roof panel at the locations indicated. **If necessary, slide the truss to align its holes with the panel.**
- Insérer les premières deux **vis (ADZ)** à travers le pignon et dans le panneau de toit et les premières deux **vis (ADZ)** à travers la ferme et dans le panneau de toit aux emplacements indiqués. **Si besoin, faire glisser la ferme pour aligner les ses trous avec ceux du panneau.**
- Insertar los primeros dos **tornillos (ADZ)** por la fachada y dentro del panel de tejado y los primeros dos **tornillos (ADZ)** por la cercha y dentro del panel de tejado a las ubicaciones indicadas. **Si es necesario, deslizar el armazón para alinear sus agujeros con ellos en el panel.**

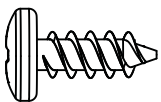
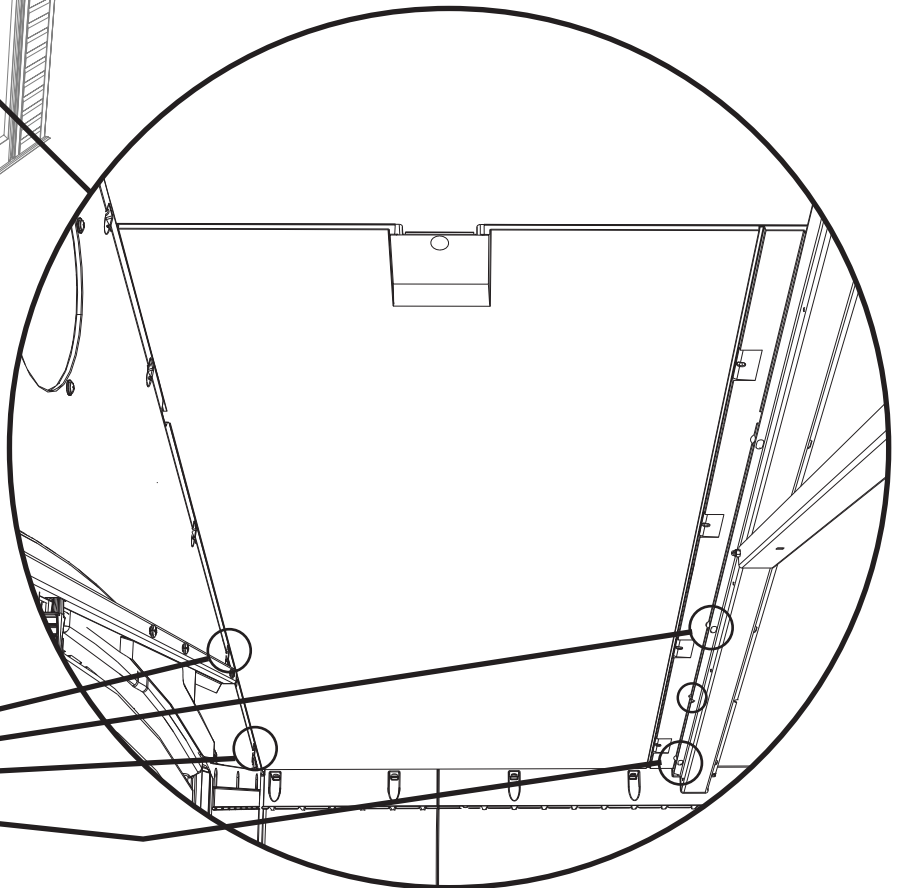
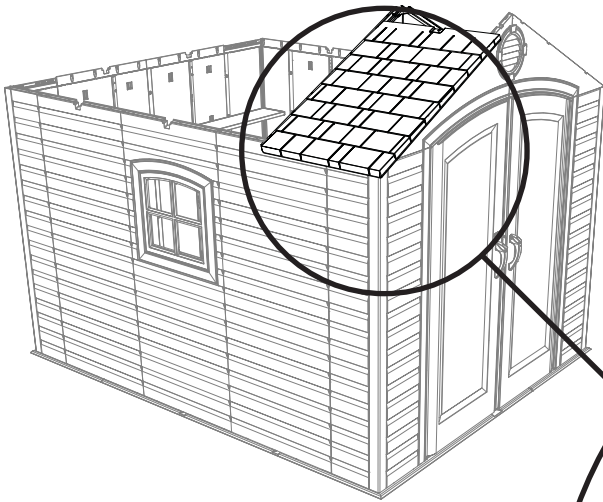

ADZ (x4)

► SECTION 10 (CONTINUED) / SECTION 10 (SUITE) / SECCIÓN 10 (CONTINUACIÓN)

TOOLS AND HARDWARE REQUIRED / OUTILS ET QUINCAILLERIE REQUIS / INSTRUMENTAL Y HERRAJE REQUERIDOS

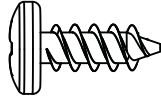

ADZ (x3)

10.5

- Insert the **roof support (AFL)** into the notches in the gable and between the truss and the roof panel. Insert three (3) more **screws (ADZ)** to secure the panel in place.
- Mettre le **support de toit (AFL)** dans les encoches dans le pignon et entre le panneau de toit et la ferme. Insérer trois (3) **vis (ADZ)** pour attacher le panneau en place.
- Insertar el **soporte de tejado (AFL)** en las muescas en la fachada y entre la cercha y el panel de tejado. Insertar tres (3) **tornillos (ADZ)** más para sujetar el panel en su lugar.

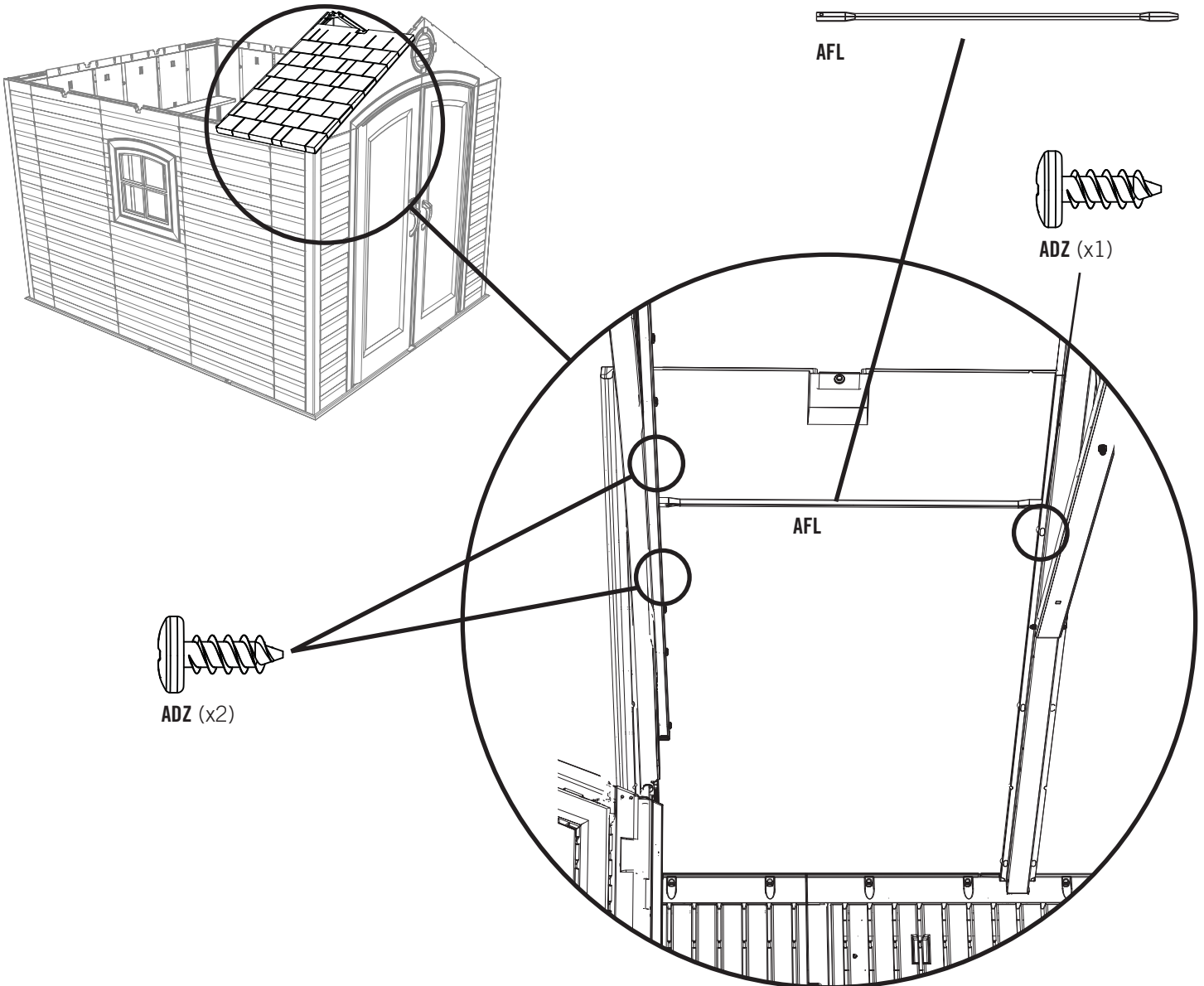

► SECTION 10 (CONTINUED) / SECTION 10 (SUITE) / SECCIÓN 10 (CONTINUACIÓN)

TOOLS AND HARDWARE REQUIRED / OUTILS ET QUINCAILLERIE REQUIS / INSTRUMENTAL Y HERRAJE REQUERIDOS

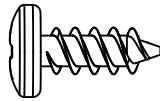

ADZ (x11)

10.6

- Repeat steps 10.2–10.5 for the second front roof panel.
- Répéter les étapes 10.2 – 10.5 pour le deuxième panneau de toit avant.
- Repetir los pasos 10.2–10.5 para el segundo panel de tejado delantero.

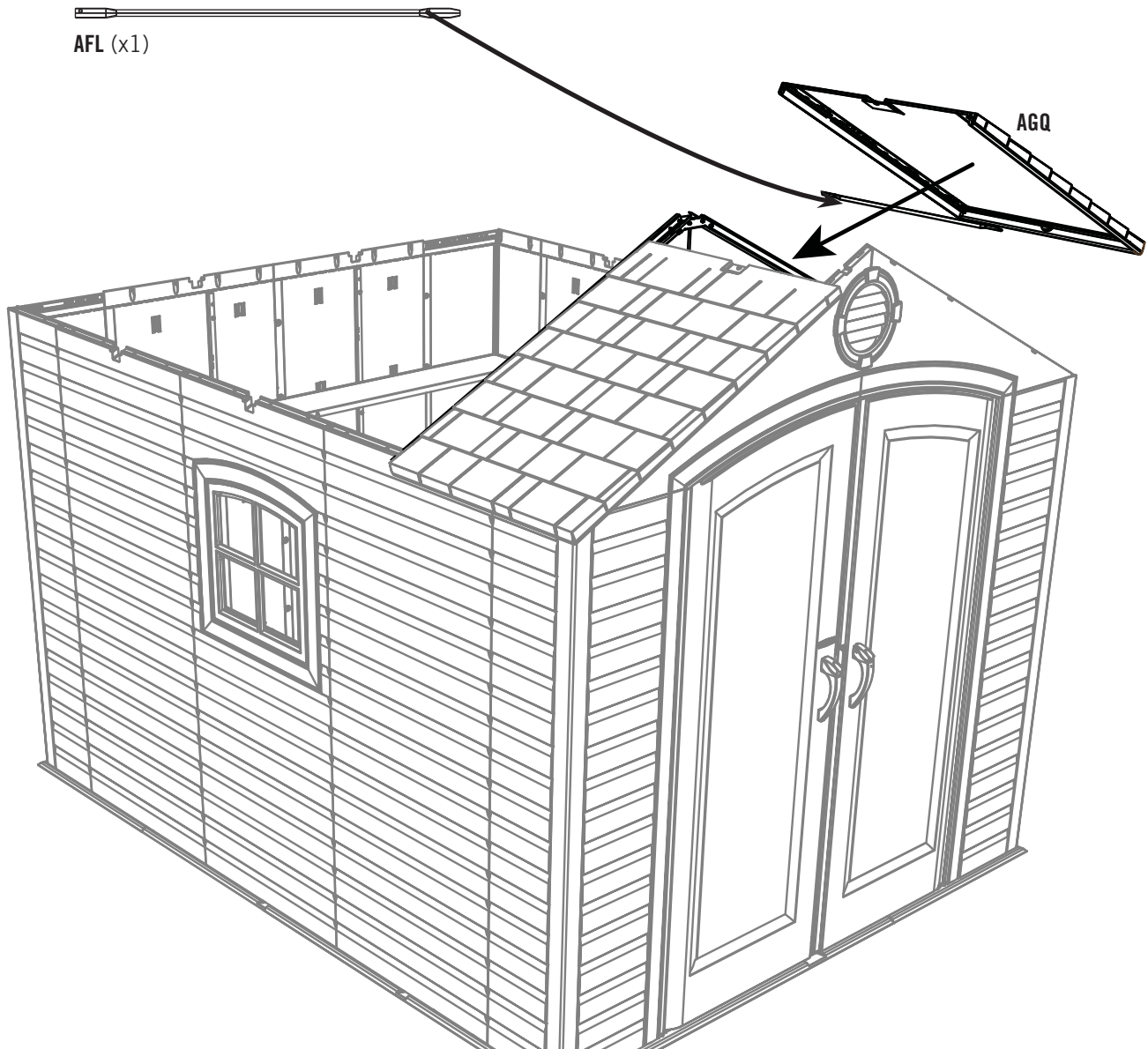

► SECTION 10 (CONTINUED) / SECTION 10 (SUITE) / SECCIÓN 10 (CONTINUACIÓN)

TOOLS AND HARDWARE REQUIRED / OUTILS ET QUINCAILLERIE REQUIS / INSTRUMENTAL Y HERRAJE REQUERIDOS

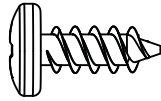

ADZ (x40)

10.7

- Repeat the previous steps for the center roof panels.
- Répéter les étapes précédentes pour les panneaux de toit centraux.
- Repetir los pasos anteriores para los paneles de tejado centrales.

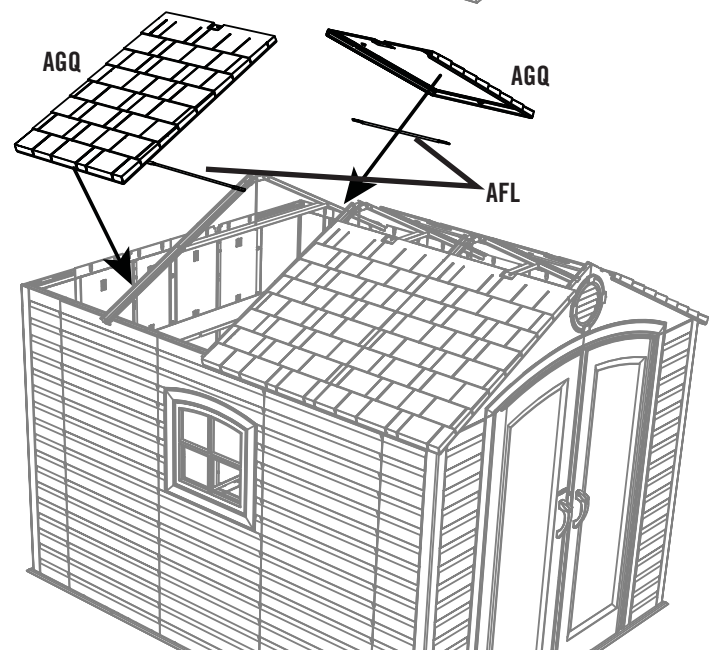
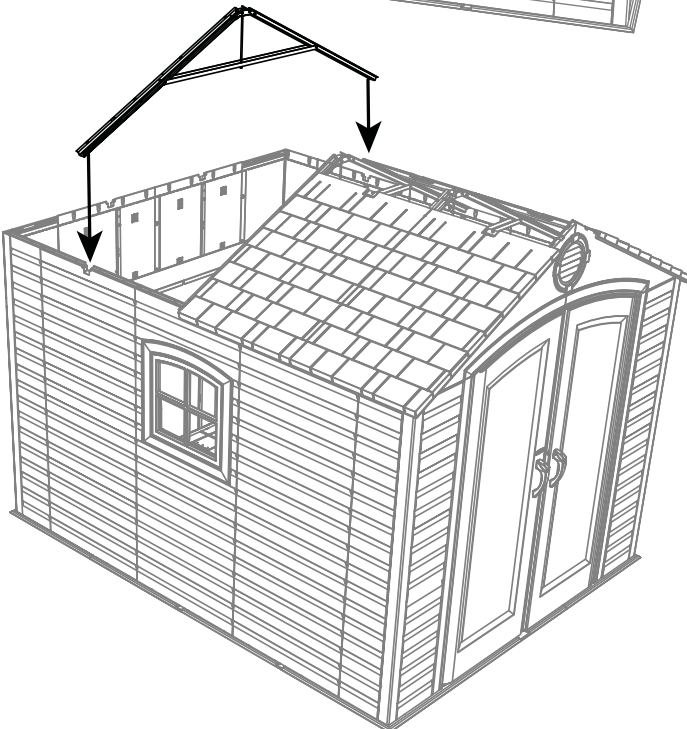
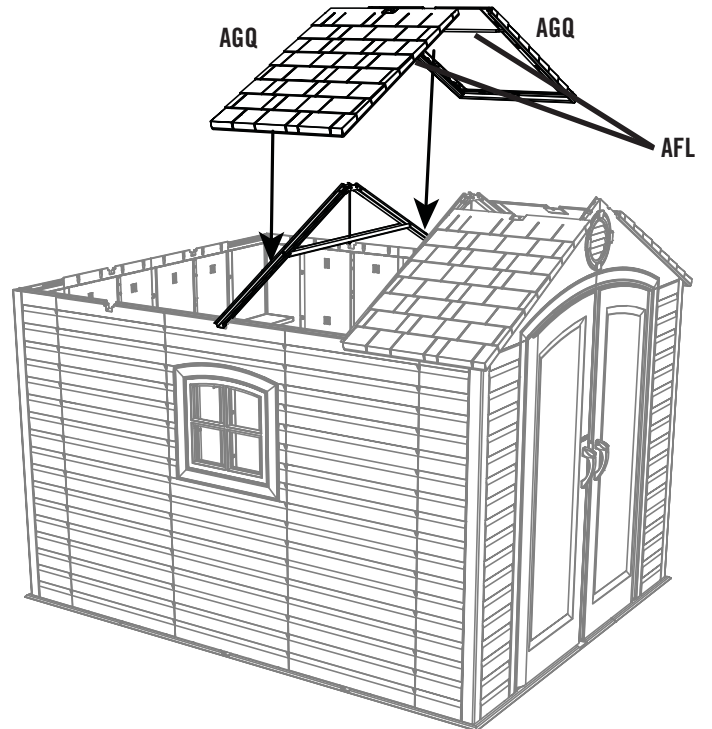
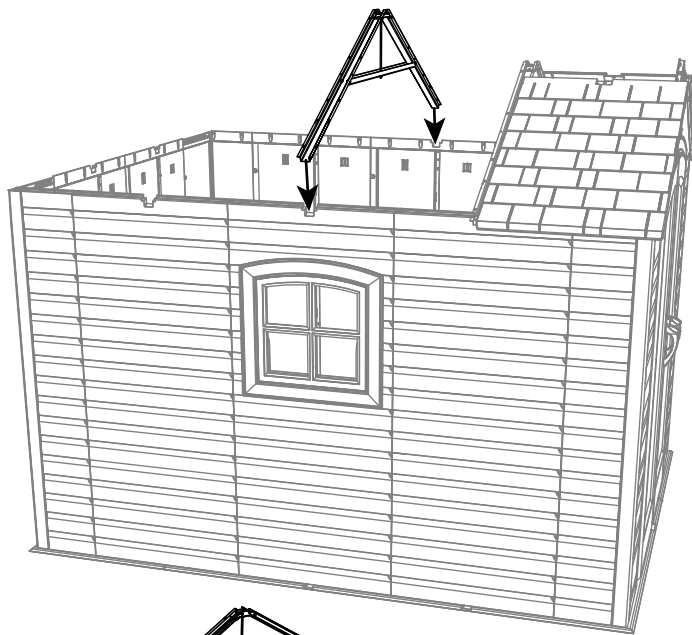

► SECTION 10 (CONTINUED) / SECTION 10 (SUITE) / SECCIÓN 10 (CONTINUACIÓN)

TOOLS AND HARDWARE REQUIRED / OUTILS ET QUINCAILLERIE REQUIS / INSTRUMENTAL Y HERRAJE REQUERIDOS

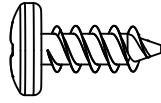

ADZ (x14)

10.8

- Attach the rear gable to the shed using fourteen (14) **screws (ADZ)**. Place the end of the gable onto the interior surface of the rear wall.
- Attacher le pignon arrière à l'abri à l'aide de quatorze (14) **vis (ADZ)**. Mettre l'extrémité du pignon sur la surface intérieure du mur arrière.
- Sujetar la fachada trasera a la casita usando catorce (14) **tornillos (ADZ)**. Colocar el extremo de la fachada en la superficie interior del muro trasero.

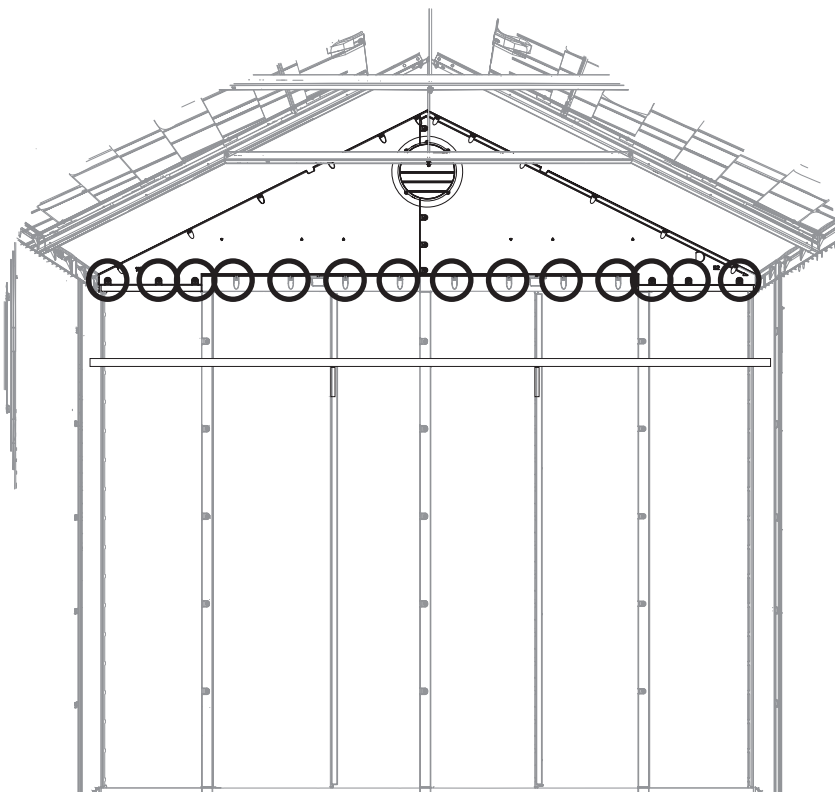
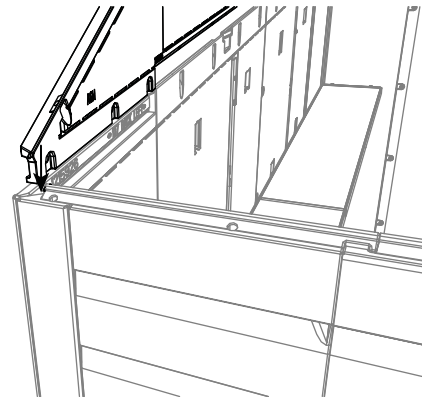
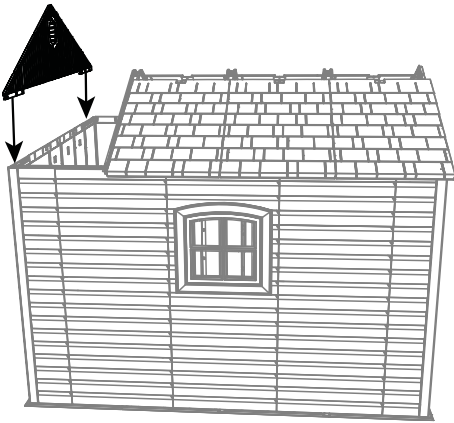

► SECTION 10 (CONTINUED) / SECTION 10 (SUITE) / SECCIÓN 10 (CONTINUACIÓN)

TOOLS AND HARDWARE REQUIRED / OUTILS ET QUINCAILLERIE REQUIS / INSTRUMENTAL Y HERRAJE REQUERIDOS

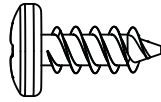

ADZ (x22)

10.9

- Attach the last two roof panels to the shed in the same way you did the first two.
- Attacher les derniers deux panneaux de toit à l'abri dans la même façon que les premiers deux.
- Sujetar los últimos dos paneles de tejado a la casita en la misma manera que los primeros dos.

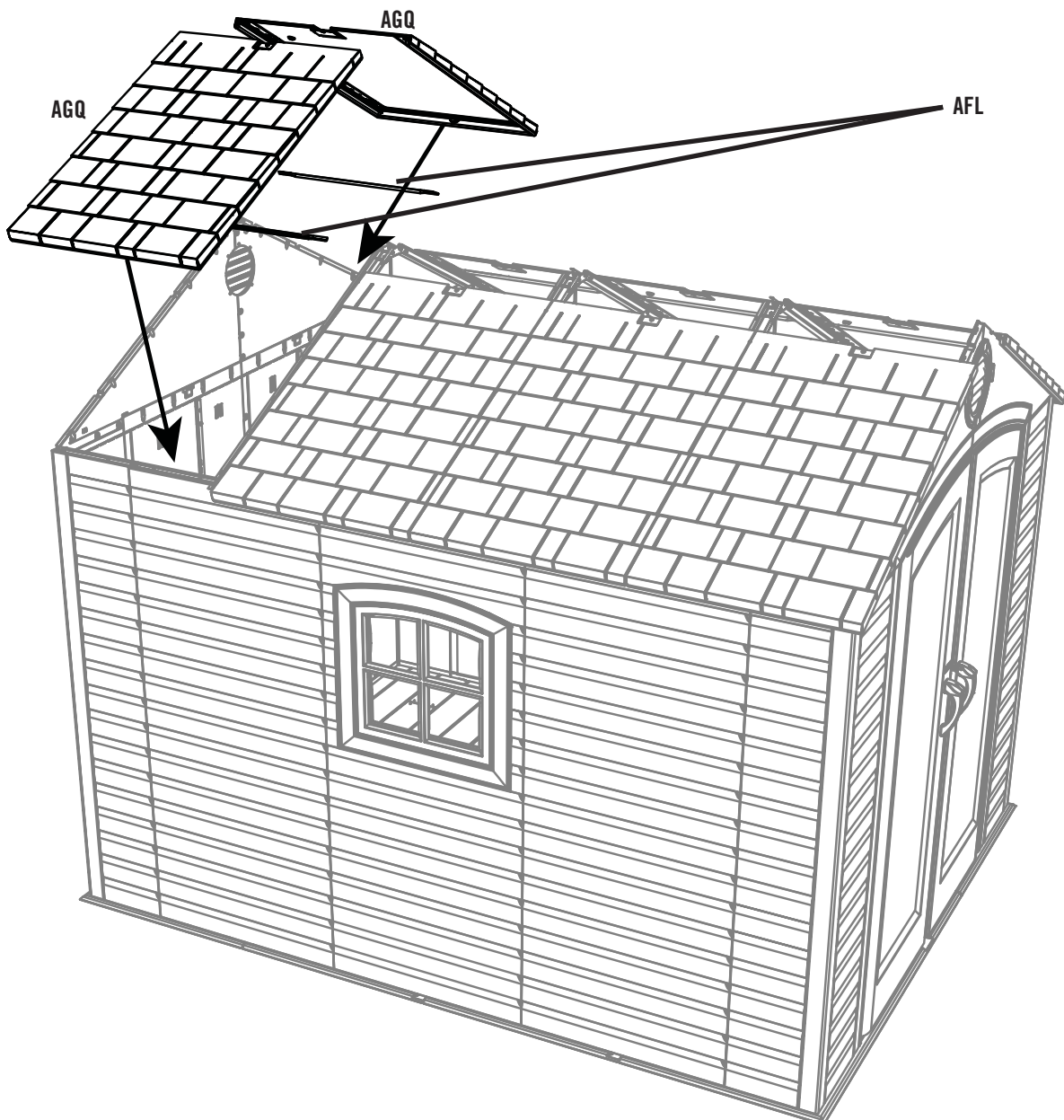

► SECTION 10 (CONTINUED) / SECTION 10 (SUITE) / SECCIÓN 10 (CONTINUACIÓN)

TOOLS AND HARDWARE REQUIRED / OUTILS ET QUINCAILLERIE REQUIS / INSTRUMENTAL Y HERRAJE REQUERIDOS

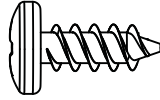

ADZ (x28)

10.10

- Starting at the front, attach the roof caps to the shed using the hardware included. The ends of the roof caps overlap one another.
- En commençant à la partie avant, attacher les chapeaux à l'abri à l'aide de la quincaillerie incluse. Les extrémités des chapeaux se chevauchent.
- Empezando a la parte delantera, sujetar las cumbresras a la casita usando el herraje incluido. Los extremos de las cumbresras se solapan.

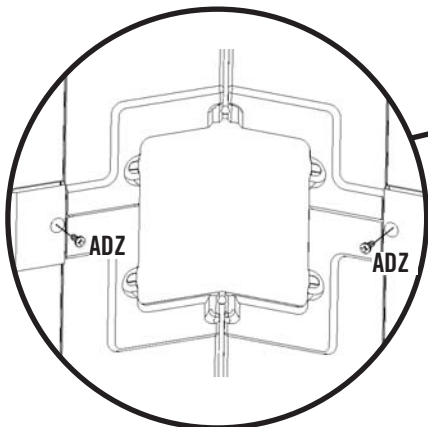
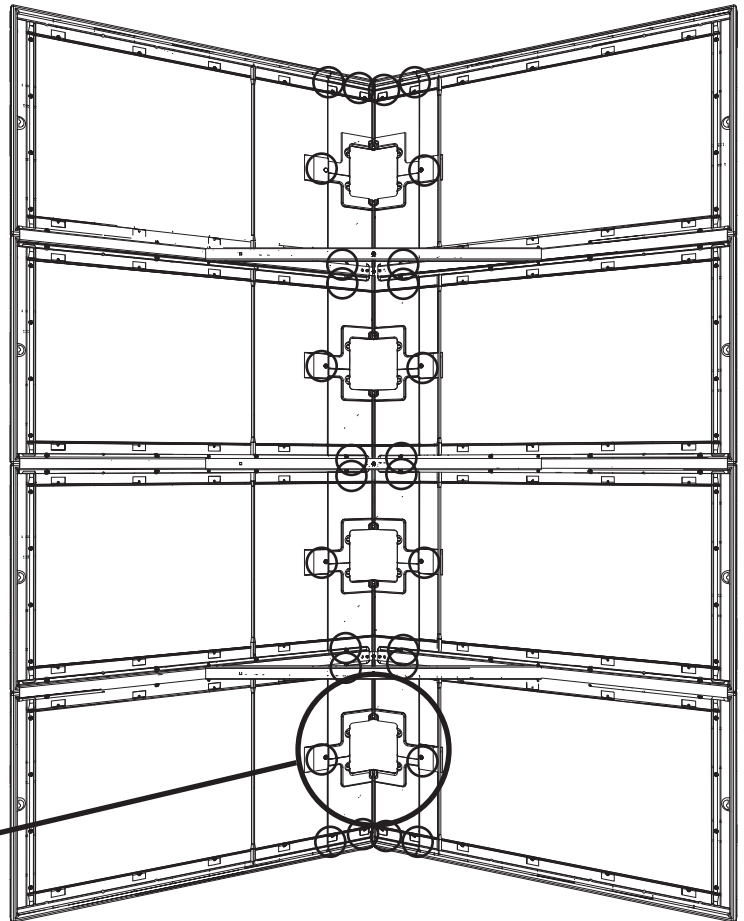
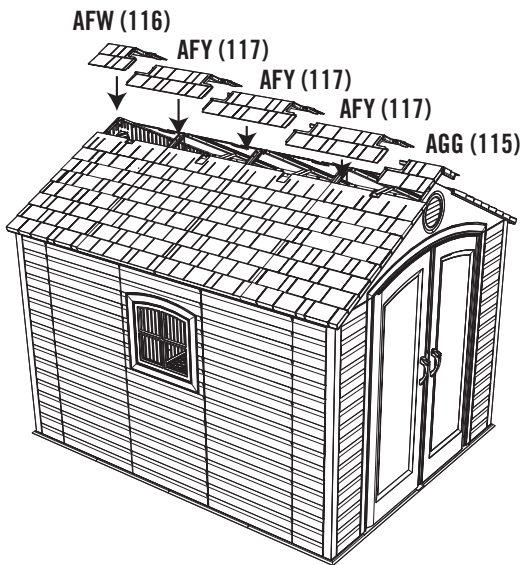

► SECTION 10 (CONTINUED) / SECTION 10 (SUITE) / SECCIÓN 10 (CONTINUACIÓN)

TOOLS AND HARDWARE REQUIRED / OUTILS ET QUINCAILLERIE REQUIS / INSTRUMENTAL Y HERRAJE REQUERIDOS

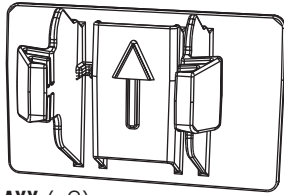

AXX (x2)

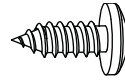

ADX (x24)

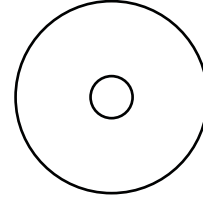

AED (x24)

10.11



- Fold a **skylight (AHC)**, and attach it to the roof using six (6) **screws (ADX)** and **washers (AED)** for each skylight. Repeat this step for the four remaining skylights.
- Plier une **lucarne (AHC)**, et l'attacher au toit à l'aide de six (6) **vis (ADX)** et **rondelles (AED)** pour chaque lucarne. Répéter cette étape pour les quatre lucarnes restantes.
- Doblar un **tragaluz (AHC)**, y sujetarlo al tejado usando seis (6) **tornillos (ADX)** y **rondanas (AED)** para cada tragaluz. Repetir este paso para los cuatro tragaluzes restantes.

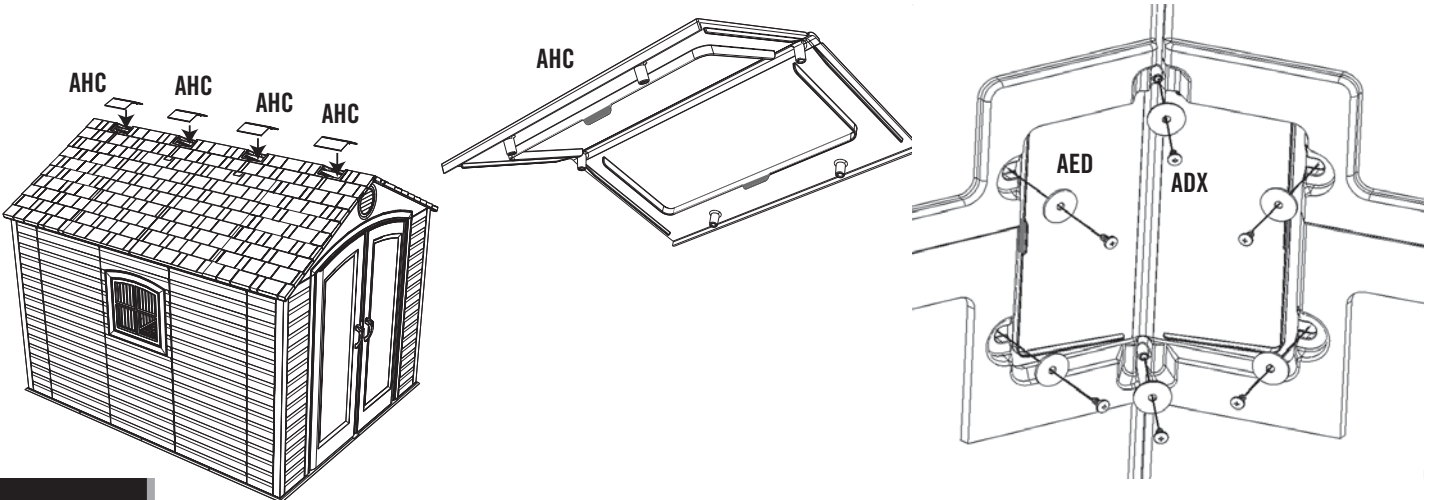

10.12

- Insert the **clips (AXX)** with the "arrow" facing up.
- Insérer les **clips (AXX)** avec la « flèche » vers le haut.
- Insertar los **clips (AXX)** con la « flecha » hacia arriba.

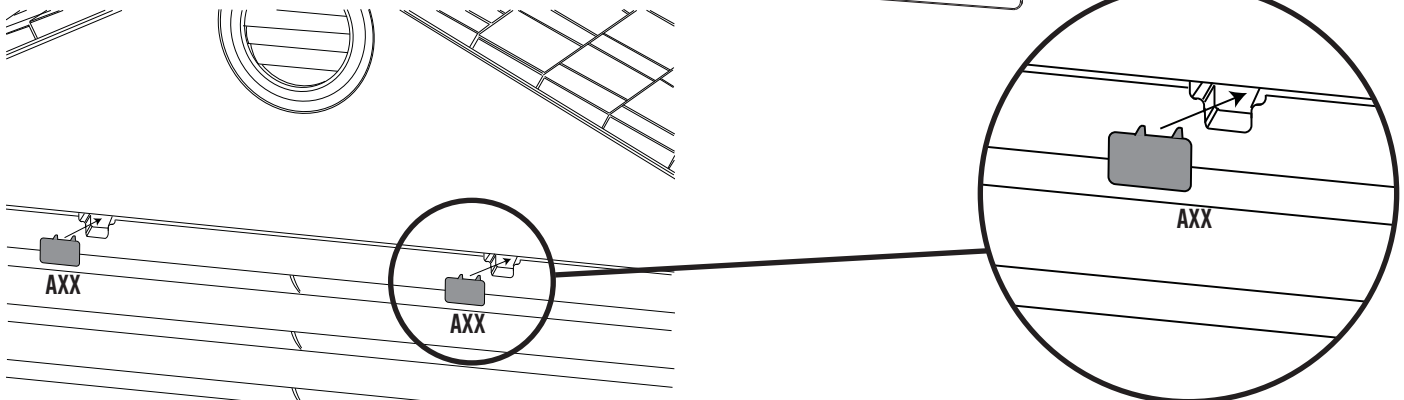
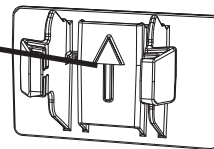

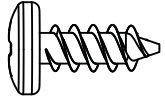

HARDWARE REQUIRED / HERRAJE REQUERIDO / QUINCAILLERIE REQUISE

Hardware Bag / Sac de quincaillerie / Bolsa de herraje

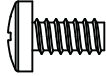

ADZ (x4)



ADY (x1)

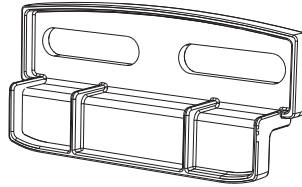

AIS (x2)

PARTS REQUIRED / PIÈCES REQUISES / PIEZAS REQUERIDAS

Plastic Parts / Pièces en plastique / Piezas de plástico

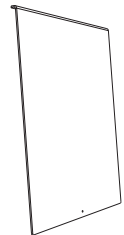

AHE (x1)



TOOLS REQUIRED (NOT INCLUDED—UNLESS INDICATED OTHERWISE*) / OUTILS REQUIS (NON INCLUS — SAUF INDICATION CONTRAIRE*) / INSTRUMENTAL REQUERIDO (NO INCLUIDO, SALVO INDICACIÓN CONTRARIA*)



► SECTION 11 (CONTINUED) / SECTION 11 (SUITE) / SECCIÓN 11 (CONTINUACIÓN)

TOOLS AND HARDWARE REQUIRED / OUTILS ET QUINCAILLERIE REQUIS / INSTRUMENTAL Y HERRAJE REQUERIDOS



- In case of any trouble with this section, scan the QR code below to view a video on its assembly.
- En cas de problème avec cette section, scanner le QR code en dessous pour voir une vidéo de l'assemblage.
- En caso de problemas con esta sección, escanear el código QR debajo para ver un video del ensamblaje.



<http://go.Lifetime.com/8x10storageshed-section11>

11.1

- Peel off the protective backing from both sides of the **Window Pane (AHE)**.
- Retirez la pellicule protectrice des deux côtés du **Carreau (AHE)**.
- Retire el protector de plástico de las dos caras de la **Hoja de ventana (AHE)**.

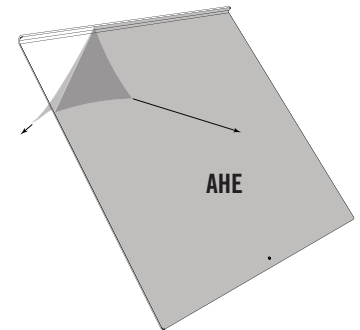

11.2

- With the curved edge at the top and facing toward you, slide the Window Pane down into the opening.
- Avec le bord courbé vers le haut et faisant face de vous, faites glisser le Carreau en place.
- Con el borde curvado hacia arriba y el interior, deslice la Hoja de ventana en su lugar.

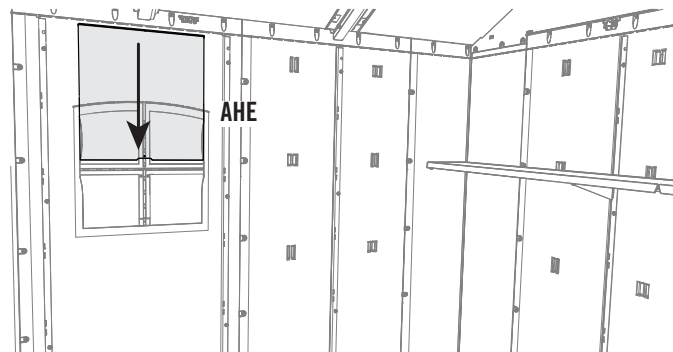

► SECTION 11 (CONTINUED) / SECTION 11 (SUITE) / SECCIÓN 11 (CONTINUACIÓN)

TOOLS AND HARDWARE REQUIRED / OUTILS ET QUINCAILLERIE REQUIS / INSTRUMENTAL Y HERRAJE REQUERIDOS

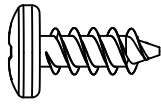

ADZ (x4)

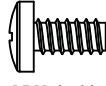

ADY (x1)

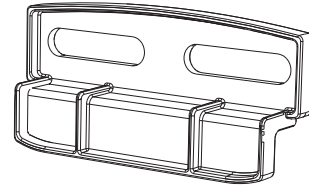

AIS (x2)

11.3

- Insert a **Screw (ADY)** into the hole at the bottom of the Window Pane. **This helps keep the Window Pane up when open.**
- Insérez une **Vis (ADY)** dans le trou au bord inférieur du Carreau. **Cela aide à maintenir le Carreau en haut lorsqu'il est ouvert.**
- Introduzca un **Tornillo (ADY)** en el agujero al borde inferior de la Hoja de ventana. **Esto ayuda a prevenir la cierre de la Hoja.**

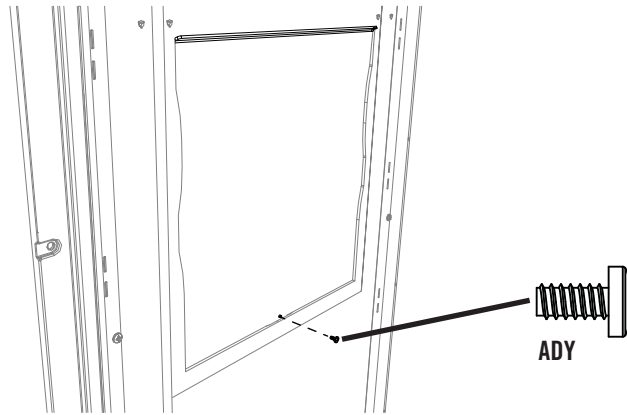

11.4

- Attach the two (2) **Window Latches (ADY)** at the top corners of the Panel opening. **The latch should move freely.**
- Attachez les deux (2) **Loquets (ADY)** aux angles supérieurs de l'ouverture du Panneau. **Le loquet doit se déplacer librement.**
- Sujete los dos (2) **Cerrojos (ADY)** a las esquinas superiores de la abertura del Panel. **El cerrojo debe mover libremente.**

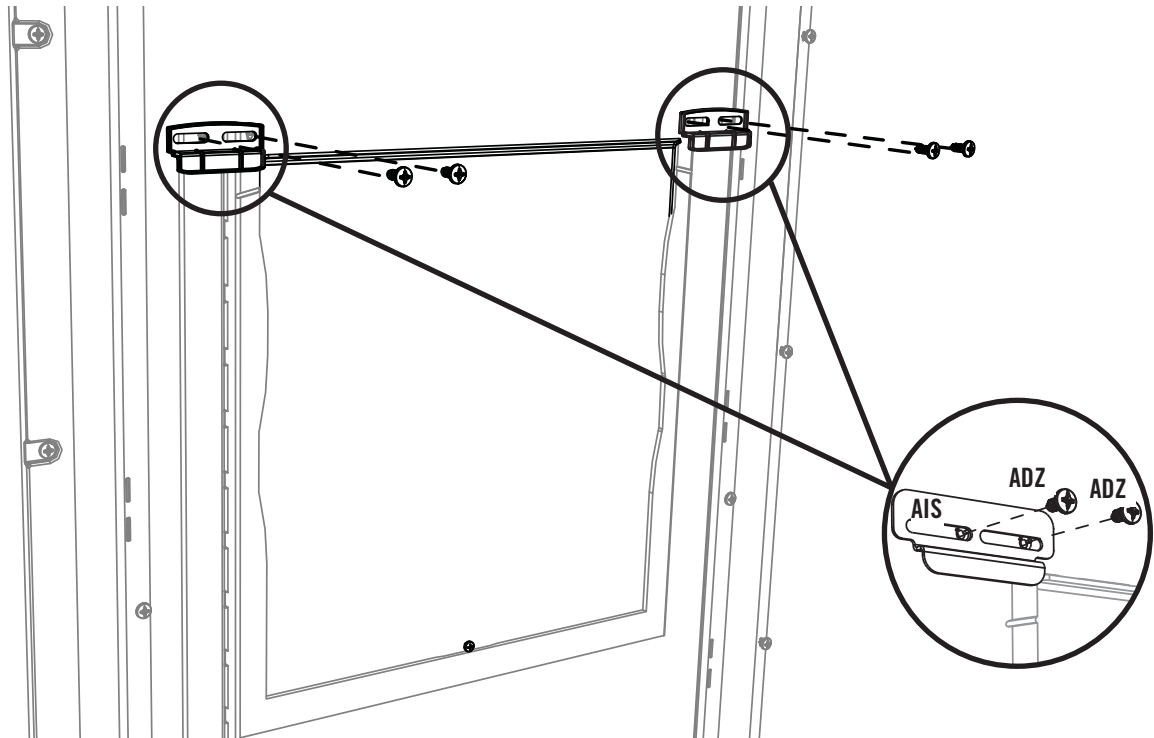



HARDWARE REQUIRED / QUINCAILLERIE REQUISE / HERRAJE REQUERIDO

*NO HARDWARE INCLUDED FOR THIS SECTION
AUCUNE QUINCAILLERIE INCLUSE POUR CETTE SECTION
NINGÚN HERRAJE INCLUIDO PARA ESTA SECCIÓN*



PARTS REQUIRED / PIÈCES REQUISES / PIEZAS REQUERIDAS

Plastic Parts / Pièces en plastique / Piezas de plástico

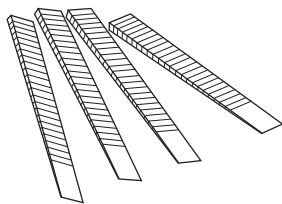

AIX (x4)



TOOLS REQUIRED (NOT INCLUDED—UNLESS INDICATED OTHERWISE*) / OUTILS REQUIS (NON INCLUS — SAUF INDICATION CONTRAIRE*) / INSTRUMENTAL REQUERIDO (NO INCLUIDO, SALVO INDICACIÓN CONTRARIA*)

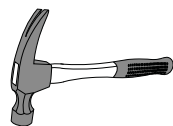

► SECTION 12 (CONTINUED) / SECTION 12 (SUITE) / SECCIÓN 12 (CONTINUACIÓN)

TOOLS AND HARDWARE REQUIRED / OUTILS ET QUINCAILLERIE REQUIS / INSTRUMENTAL Y HERRAJE REQUERIDOS



AIX (x4)



12.1

- If the Doors are not level, follow the steps on this page or the next to even them out.
- Si les portes ne sont pas niveaux l'une avec l'autre, suivre les étapes dans cette page ou la suivante pour les niveler.
- Si las puertas no están niveladas, seguir los pasos en esta página o la siguiente para nivelarlas.



12.2

- If the Right Door scrapes the Floor or is lower than the Left Door, insert a **Shim (AIX)** under the Floor directly under the bottom corner of the Right Door and/or the left rear corner of the shed. If necessary, repeat for the Left Door until both Doors are level and do not scrape. **Break off any excess Shim.**
- Si la porte droite frotte en se ferme ou est plus bas que la porte gauche, insérer une **cale (AIX)** sous le plancher directement sous le coin droit inférieur de la porte droite et/ou l'encoignure arrière gauche de l'abri. S'il est nécessaire, répéter cette étape pour la porte gauche jusqu'à ce que les deux portes soient nivelées et ne frottent pas. **Détacher de l'excès des cales.**
- Si la puerta derecha se roza con el piso o es más bajo que la izquierda, insertar una **cuña (AIX)** debajo el piso directamente debajo la esquina inferior derecha de la puerta derecha y/o la esquina izquierda trasera de la caseta. Si es necesario, repetir este paso para la puerta izquierda o hasta que las dos puertas estén niveladas y no se rocen. **Quebrantar cualquier exceso de las cuñas.**

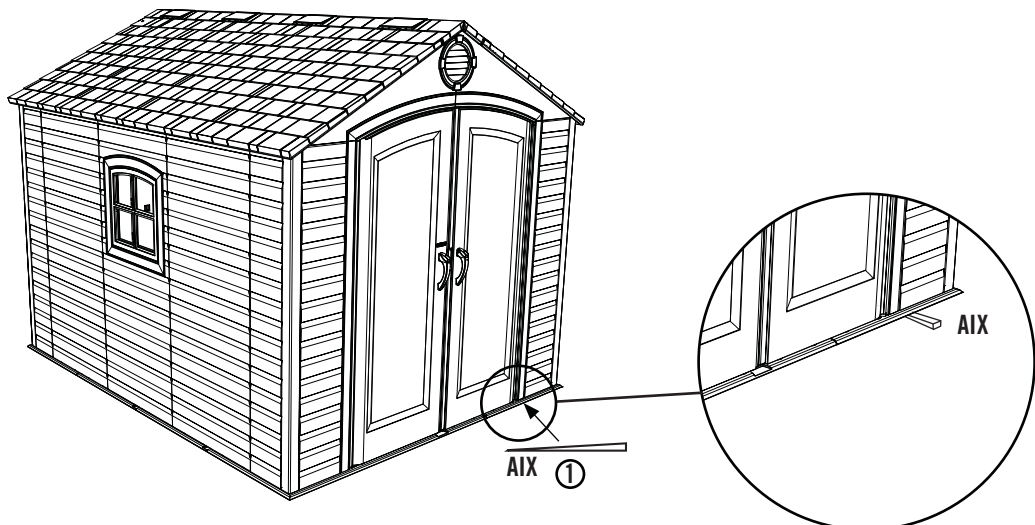



HARDWARE REQUIRED / QUINCAILLERIE REQUISE / HERRAJE REQUERIDO

*NO HARDWARE INCLUDED FOR THIS SECTION
AUCUNE QUINCAILLERIE INCLUSE POUR CETTE SECTION
NINGÚN HERRAJE INCLUIDO PARA ESTA SECCIÓN*



PARTS REQUIRED / PIÈCES REQUISES / PIEZAS REQUERIDAS

*NO PARTS REQUIRED FOR THIS SECTION
AUCUNE PIÈCE REQUISE POUR CETTE SECTION
NINGUNA PIEZA REQUERIDA PARA ESTA SECCIÓN*



TOOLS REQUIRED (NOT INCLUDED—UNLESS INDICATED OTHERWISE*) / OUTILS REQUIS (NON INCLUS — SAUF INDICATION CONTRAIRE*) / INSTRUMENTAL REQUERIDO (NO INCLUIDO, SALVO INDICACIÓN CONTRARIA*)

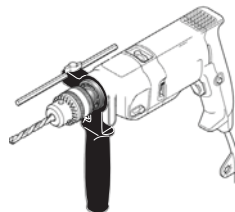
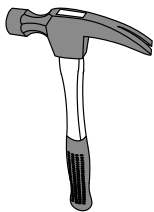

5/16 in (≈8 mm) Wood Drill Bit
Foret à boit de 5/16 po (≈8 mm)
Broca para madera de 5/16 in (≈8 mm)



5/16 in (≈8 mm) Masonry Drill Bit
Foret à maçonnerie de 5/16 po (≈8 mm)
Broca para albañilería de 5/16 in (≈8 mm)

► SECTION 13 (CONTINUED) / SECTION 13 (SUITE) / SECCIÓN 13 (CONTINUACIÓN)

FOR CONCRETE PLATFORMS / POUR LES PLATE-FORMES EN BÉTON / PARA PLATAFORMAS DE CONCRETO



5/16 in/po
(≈8 mm)



13.1



- To anchor your shed, you must purchase the correct anchoring hardware. **For a concrete platform**, we recommend using a hammer drill, 5/16 in (8 mm) masonry bit, eight (8) 3/8 in x 2 in (≈10 mm x 5 cm) Concrete Screws and eight (8) 3/8 in x 1 in (≈10 mm x 2,5 cm) Fender Washers. **Do not exceed a 3/8 in diameter screw. Refer to your local hardware store for this hardware.**
- Pour ancrer l'abri, il faut acheter la quincaillerie d'ancrage correcte. **Pour une plate-forme en béton**, nous recommandons l'utilisation d'une perceuse de percussion, un foret à maçonnerie de 5/16 po (≈8 mm), huit (8) vis d'ancrage à béton de 3/8 po x 2 po (≈10 mm x 5 cm) et huit (8) rondelles de protection de 3/8 po x 1 po (≈10 mm x 2,5cm). **Ne pas dépasser un diamètre de 3/8 po (≈10 mm). la quincaillerie locale aura ces accessoires.**
- Para anclar la caseta, es necesario comprar el herraje de anclaje correcto. **Para una plataforma de concreto**, recomendamos el uso de un martillo perforador, broca de albañilería de 5/16 in (≈8 mm), ocho (8) tornillos de anclaje para concreto de 3/8 in x 2 in (≈10 mm x 5 cm) y ocho (8) rondanas de protección de 3/8 in x 1 in (≈10 mm x 2,5 cm). **No exceder un diámetro de 3/8 in (≈10 mm). Referirse a la ferretería local para obtener este herraje.**

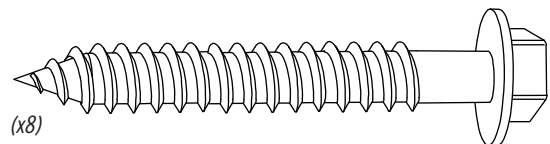
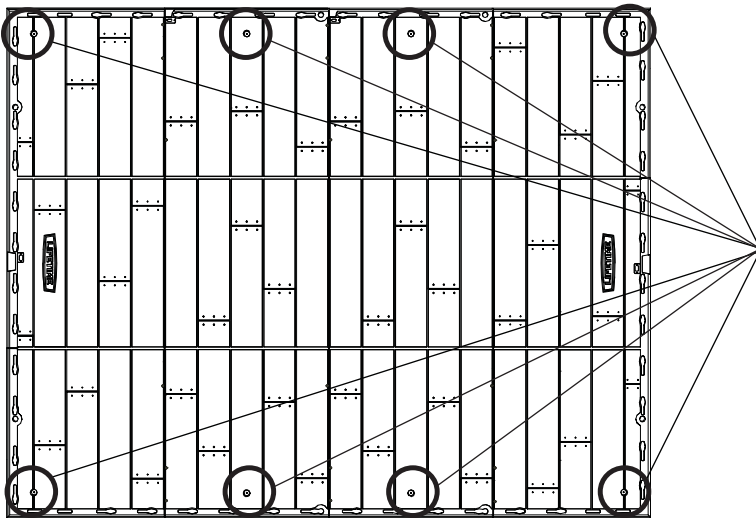

(x8)

(Not included) (Pas incluses) (No incluidos)

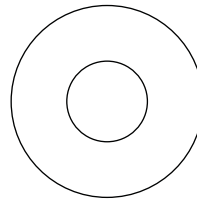

(x8)

(Not included) (Pas incluses) (No incluidos)



WARNING / AVERTISSEMENT / ADVERTENCIA



- Failure to anchor the shed may result in property damage and/or personal injury.
- Si vous n'ancrez pas votre abri, des dommages à la propriété et/ou des blessures peuvent en résulter.
- No anclar la caseta puede resultar en daños a la propiedad y/o en lesiones personales.

► SECTION 13 (CONTINUED) / SECTION 13 (SUITE) / SECCIÓN 13 (CONTINUACIÓN)

FOR WOOD PLATFORMS / POUR LES PLATE-FORMES EN BOIS / PARA PLATAFORMAS DE MADERA



5/16 in/po
(8 mm)



13.1



- To anchor your shed, you must purchase the correct anchoring hardware. **For a wood-framed platform**, we recommend using a drill, 5/16 in (≈ 8 mm) drill bit, eight (8) 3/8 in x 1 1/2 in (≈ 10 mm x 4 cm) Lag Screws and eight (8) 3/8 in x 1 in (≈ 10 mm x 2,5 cm) Fender Washers. **Do not exceed a 3/8 in diameter screw. Refer to your local hardware store for this hardware.**
- Pour ancrer l'abri, il faut acheter la quincaillerie d'ancrage correcte. **Pour une plate-forme en bois**, nous recommandons l'utilisation d'une perceuse électrique, un foret de 5/16 po (≈ 8 mm), huit (8) vis de retard de 3/8 po x 1 1/2 po (≈ 10 mm x 4 cm), et huit (8) rondelles de protection de 3/8 po x 1 po (≈ 10 mm x 2,5cm). **Ne pas dépasser un diamètre de 3/8 po (≈ 10 mm). La quincaillerie locale aura ces accessoires.**
- Para anclar la caseta, es necesario comprar el herraje de anclaje correcto. **Para una plataforma hecho de hecho de madera**, recomendamos el uso de un taladro eléctrico, una broca de 5/16 in (≈ 8 mm), ocho (8) tornillos para madera de 3/8 in x 1 1/2 in (≈ 10 mm x 4 cm) y ocho (8) rondanas de protección de 3/8 in x 1 in (≈ 10 mm x 2,5 cm). **No exceder un diámetro de 3/8 in (≈ 10 mm). Referirse a su ferretería local para obtener este herraje.**

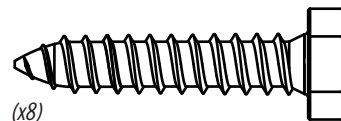
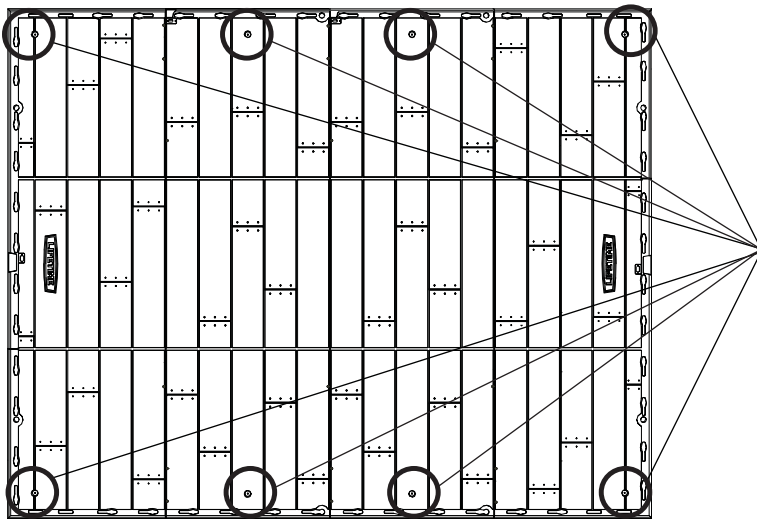

(x8)

(Not included) (Pas incluses) (No incluidos)

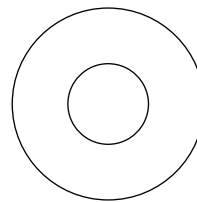

(x8)

(Not included) (Pas incluses) (No incluidos)



WARNING / AVERTISSEMENT / ADVERTENCIA



- Failure to anchor the shed may result in property damage and/or personal injury.
- Si vous n'ancrez pas votre abri, des dommages à la propriété et/ou des blessures peuvent en résulter.
- No anclar la caseta puede resultar en daños a la propiedad y/o en lesiones personales.

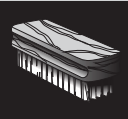

CLEANING & CARE

Congratulations on your Lifetime® product purchase. By following the instructions below, your new Lifetime product should provide you with years of service and enjoyment.

The polyethylene panels are stain and solvent resistant. Most stains can be removed using a mild soap and a soft-bristled brush. Abrasive cleaning materials may scratch the plastic and are not recommended. Repair scratches or rust spots on the metal by sanding the affected area lightly; using a rust preventative spray primer; and finally, spraying with a high-gloss spray enamel paint. Avoid placing a direct heat source on or near surfaces unless using a heat barrier.

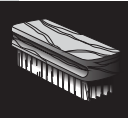

NETTOYAGE ET ENTRETIEN

Nous vous félicitons d'avoir acheté ce produit Lifetime®. En suivant les instructions ci-dessous, votre nouveau produit Lifetime devrait vous fournir des années de service et de plaisir.

Les murs et les étagères en polyéthylène sont résistants aux taches et solvants de nettoyage. Pour les nettoyer, se servir d'un savon doux et d'une brosse douce. Les produits abrasifs de nettoyage risquent d'égratigner le plastique et ne sont pas recommandés. Pour réparer les égratignures ou taches de rouille sur le métal, frotter légèrement l'endroit affecté au papier de verre, puis passer une couche de produit vaporisant préventif, et, enfin, vaporiser une peinture émail ultrabrillante. Éviter de placer une source de chaleur directe sur ou près des surfaces, ou les protéger à l'aide d'une protection contre la chaleur.



LIMPIEZA Y CUIDADO

Felicidades por la compra de su producto Lifetime®. Al seguir las siguientes instrucciones, su nuevo producto Lifetime le brindará años de servicio y satisfacción.

Los paneles de polietileno son resistentes a las manchas y solventes. La mayoría de las manchas puede removerse usando un jabón suave y un cepillo de cerdas suaves. Los materiales abrasivos para limpieza pueden rayar el plástico y no se recomiendan. Reparar rayones o manchas de óxido en el metal, lijando suavemente la parte afectada; usando un aerosol preventivo de óxido y finalmente, rociando con una pintura de esmalte brillante. Evitar poner una fuente de calor directa en o cerca de las superficies sin usar una barrera de calor.



REGISTER YOUR PRODUCT ONLINE AT WWW.LIFETIME.COM

At Lifetime®, we are committed to providing innovative and quality products. While registering, you will have the opportunity to give us your feedback. Your input is valuable to us.

- You can also opt in to receive new product notifications or promotions.
- In the unlikely event of a product recall or safety modification, your registration provides the information we need to notify you directly.
- Registration is fast, easy, and completely voluntary.

LIFETIME'S PROMISE TO YOU:

Maintaining your privacy is our long-standing policy at Lifetime®. And you can rest assured that Lifetime® will not sell or provide your personal data to other third parties, or allow them to use your personal data for their own purposes.

We invite you to read our privacy policy at www.lifetime.com

REGISTER today!



ENREGISTRER CE PRODUIT EN LIGNE À WWW.LIFETIME.COM

Chez Lifetime®, nous nous engageons à fournir des produits innovateurs de qualité. Lors de votre inscription, vous aurez l'occasion de nous faire parvenir vos commentaires. Votre opinion est importante pour nous.

- On peut également choisir de recevoir des avis ou des promotions dans le cadre de nouveaux produits.
- Dans l'éventualité improbable d'un rappel ou d'un avis de sécurité, l'inscription fournit les renseignements nécessaires nous permettant de communiquer avec vous.
- L'inscription est rapide, facile et complètement volontaire.

LA PROMESSE DE LIFETIME :

Conserver votre confidentialité est notre politique de longue date chez Lifetime®. Vous pouvez donc être rassuré par le fait que Lifetime® ne vendra pas ou ne fournira pas vos données personnelles à des tiers, et ne leur permettra pas d'utiliser vos données personnelles à leurs propres fins.

Nous vous invitons à lire notre politique de confidentialité à www.lifetime.com (en anglais seulement)

ENREGISTRER CE PRODUIT aujourd'hui!



REGISTRAR EL PRODUCTO EN LÍNEA EN WWW.LIFETIME.COM

En Lifetime®, estamos comprometidos a ofrecer productos innovadores y de calidad. Al registrarse, usted tendrá la oportunidad de darnos su retroalimentación. Su información es valiosa para nosotros.

- También puede optar por recibir nuestras notificaciones o promociones.
- En el caso improbable de que el producto deba ser retirado del mercado o que sufra alguna modificación, su registro provee la información que necesitamos para notificarle directamente.
- El registro es rápido, fácil y completamente voluntario.

LA PROMESA DE LIFETIME® PARA USTED:

Mantener privacidad es nuestra política permanente en Lifetime®. Y puede estar seguro que Lifetime® no venderá ni dará datos personales a terceros, ni les permitirá usar datos personales para sus propios fines.

Lo invitamos a leer nuestra política de privacidad en www.lifetime.com (sólo en inglés)

¡REGISTRARSE hoy mismo!



10-YEAR LIMITED FACTORY WARRANTY

THE MANUFACTURER RESERVES THE RIGHT TO MAKE SUBSTITUTIONS TO WARRANTY CLAIMS IF PARTS ARE UNAVAILABLE OR OBSOLETE.

Lifetime Lawn and Garden products are warranted to the original purchaser to be free from defects in material or workmanship for a period of 10 years from the date of original retail purchase. The word “defects” is defined as imperfections that impair the use of the product. Defects resulting from misuse, abuse or negligence will void this warranty. This warranty does not cover defects due to improper installation, alteration or accident. Lifetime recommends that no modifications be made to this product. This warranty does not cover damage caused by vandalism, rusting, “acts of nature”, natural disasters, normal wear and tear, or any other event beyond the control of the manufacturer.

This warranty is nontransferable and is expressly limited to the repair or replacement of defective products. If the product is defective within the terms of this warranty, Lifetime Products, Inc. will repair or replace defective parts at no cost to the purchaser. Shipping charges to and from the factory or distribution center are not covered and are the responsibility of the purchaser. Labor charges and related expenses for removal, installation or replacement of the product or its components are not covered under this warranty.

This warranty does not cover scratching, scuffing, or other cosmetic damage of the product that may result from normal usage. In addition, defects resulting from intentional damage, negligence, or unreasonable use will void this warranty / are not covered by this warranty.

Liability for incidental or consequential damages is excluded to the extent permitted by law. All merchandise is sold on this condition, and no representative of the company may waive or change this policy. This product is not intended for institutional or commercial use; Lifetime Products, Inc. does not assume any liability for such use. Institutional or commercial use will void the warranty.

This warranty is expressly in lieu of all other warranties, expressed or implied, including warranties of merchantability or fitness for use to extent permitted by Federal and state law. Neither Lifetime Products, Inc., nor any representative assumes any other liability in connection with this product. This warranty gives you specific legal rights, and you may also have other rights which vary from state to state.

Our goods come with guarantees that cannot be excluded under the Australian Consumer Law. You are entitled to a replacement or refund for a major failure and for compensation for any other reasonably foreseeable loss or damage. You are also entitled to have the goods repaired or replaced if the goods fail to be of acceptable quality and the failure does not amount to a major failure.

**ALL WARRANTY CLAIMS MUST BE ACCOMPANIED BY A SALES RECEIPT.
REPORT PRODUCT DEFECTS IN WRITING TO:**

LIFETIME PRODUCTS, INC.,
PO Box 160010
Freeport Center, Bldg. D-12
Clearfield, UT 84016-0010

For online warranty claims, please visit: www.lifetime.com/warranty
Warranty Department: (800) 225-3865 M-F 7 a.m. to 5 p.m. Mountain Standard Time (MST).

FOR INTERNATIONAL WARRANTY:

All warranty claims must be accompanied by a sales receipt. Report product defects in writing to your regional sales support representative. Please include your dated sales receipt and photographs of damaged parts.

To Identify the representative for your region, please visit: www.lifetime.com/international



GARANTIE DE FABRICATION LIMITÉE DE 10 ANS

LIFETIME® PRODUCTS, INC. RÉSERVE LE DROIT DE FAIRE DES SUBSTITUTIONS EN CAS DE RECOURS EN GARANTIE SI LES PIÈCES NE SONT PAS DISPONIBLES OU SONT OBSOLÈTES.

L'acheteur d'origine des produits pour pelouses et jardins de Lifetime bénéficie d'une garantie contre toute défectuosité de matériel et de fabrication pour une période de 10 ans à compter de la date d'achat. On entend par « défaut » une imperfection qui nuit à l'utilisation du produit. Tout défaut découlant d'une mauvaise utilisation, d'un abus ou d'une négligence a pour effet d'annuler cette garantie. Cette garantie ne couvre pas les défauts attribuables à une installation inadéquate, une altération ou un accident. Lifetime recommande de ne pas apporter de modifications à ce produit. Cette garantie ne couvre pas les dommages causés par le vandalisme, la corrosion par la rouille, les cas de « force majeure », les catastrophes naturelles, la détérioration et l'usure normales et tout autre événement indépendant de la volonté du fabricant.

Cette garantie n'est pas transférable et se limite expressément à la réparation ou au remplacement d'un produit défectueux. Si le produit est défectueux au sens de cette garantie, Lifetime Products, Inc. réparera ou remplacera les pièces défectueuses sans frais pour l'acheteur. Les frais d'expédition en partance ou en provenance de l'usine ou du centre de distribution ne sont pas couverts et incombent à l'acheteur. Les coûts relatifs à la main-d'œuvre et les autres frais liés au retrait, à l'installation ou au remplacement du produit ou de ses composants ne sont pas couverts par cette garantie.

Cette garantie ne couvre pas les rayures, les égratignures ou autres dommages esthétiques du produit découlant d'un usage normal. De plus, tout défaut découlant d'un dommage volontaire, de négligence ou d'un usage déraisonnable annule cette garantie et n'est pas couvert par cette garantie.

Dans la mesure permise par la loi, la société n'est pas responsable des dommages indirects ou accessoires. Toute marchandise est vendue à cette condition et aucun représentant de la société ne peut renoncer à l'application de cette politique ou la modifier. Ce produit n'est pas destiné à des fins institutionnelles ou commerciales; Lifetime Products, Inc. n'assume aucune responsabilité à cet égard. Toute utilisation institutionnelle ou commerciale annule la garantie.

La présente garantie remplace expressément toute autre garantie, expresse ou implicite, y compris les garanties de qualité marchande ou d'adaptation à un usage particulier dans la mesure permise par les lois du pays ou de l'État. Ni Lifetime Products, Inc. ni aucun de ses représentants n'assument une quelconque responsabilité en lien avec ce produit. Cette garantie vous donne des droits juridiques précis et vous pourriez également avoir d'autres droits selon l'État ou la province.

La garantie qui accompagne nos produits ne peut être exclue en vertu de la loi sur la protection du consommateur de l'Australie. Le client a droit à un remplacement ou à un remboursement en cas de bris majeur et pour toute autre perte ou dommage raisonnablement prévisible. Le client a aussi droit à ce que les produits soient réparés ou remplacés si un bris survient et rend la qualité inacceptable sans pour autant être qualifiable de bris majeur.

TOUTE RÉCLAMATION EN VERTU DE LA GARANTIE DOIT ÊTRE ACCOMPAGNÉE D'UN REÇU DE VENTE. SIGNALEMENT ÉCRIT DE TOUT PRODUIT DÉFECTUEUX :

LIFETIME PRODUCTS, INC.,
PO Box 160010
Freeport Center, Bldg. D-12
Clearfield, UT 84016-0010

Pour effectuer en ligne une réclamation sous garantie, consultez cette adresse : www.lifetime.com/warranty
Service de la garantie : (800) 225-3865 lundi au vendredi 7 h à 17 h heure normale des Rocheuses (HNR).

GARANTIE INTERNATIONALE :

Toute réclamation en vertu de la garantie doit être accompagnée d'un reçu de vente. Veuillez signaler par écrit tout produit défectueux au représentant du soutien aux ventes de votre région. Veuillez inclure le reçu de vente daté ainsi que des photographies des pièces endommagées.

Pour connaître le représentant de votre région, veuillez consulter le : www.lifetime.com/international



GARANTÍA DE FÁBRICA LIMITADA POR 10 AÑOS

EL FABRICANTE SE RESERVA EL DERECHO DE HACER SUSTITUCIONES EN LOS ELEMENTOS REEMPLAZADOS BAJO GARANTÍA SI LAS PIEZAS NO ESTÁN DISPONIBLES O SON OBSOLETAS.

El comprador original recibe una garantía de que los productos de césped y jardín de Lifetime están libres de defectos de material o mano de obra durante un período de 10 años a partir de la fecha de compra original al por menor. La palabra “defectos” se define como imperfección que imposibilita el uso del producto. Los defectos ocasionados por el mal uso, el abuso o la negligencia anularán esta garantía. Esta garantía no cubre los defectos debidos a una instalación incorrecta, una alteración o un accidente. Lifetime recomienda que no se realicen modificaciones en este producto. Esta garantía no cubre los daños causados por vandalismo, oxidación, “actos de la naturaleza”, desastres naturales, desgaste normal o cualquier otro evento fuera del control del fabricante.

Esta garantía no es transferible y se limita expresamente a la reparación o reemplazo de productos defectuosos. Si el producto resulta defectuoso dentro de los términos de esta garantía, Lifetime Products, Inc. reparará o reemplazará las piezas defectuosas sin costo alguno para el comprador. Los gastos de envío hacia y desde la fábrica o el centro de distribución no están cubiertos y son la responsabilidad del comprador. La mano de obra y los gastos relacionados por la remoción, la instalación o la sustitución del producto o sus componentes no están cubiertos por esta garantía.

Esta garantía no cubre los rayones, los raspones ni otros daños superficiales del producto que pueden resultar del uso normal. Asimismo, los defectos resultantes de daños intencionales, negligencia o uso indebido anularán o no están cubiertos por esta garantía.

Se excluye la responsabilidad por daños imprevistos o derivados en la medida en que lo permita la ley. Toda la mercancía se vende bajo estas condiciones y ningún representante de la empresa puede renunciar a ni cambiar esta política. Este producto no está destinado para uso institucional o comercial; Lifetime Products, Inc. no asume ninguna responsabilidad por dicho uso. El uso institucional o comercial anulará la garantía.

Esta garantía sustituye expresamente cualquier otra garantía, expresa o implícita, incluidas las garantías de comercialización o idoneidad para su uso en la medida permitida por la ley federal y estatal. Ni Lifetime Products, Inc., ni ningún representante asume ninguna otra responsabilidad en relación con este producto. Esta garantía le otorga derechos legales específicos y usted también puede tener otros derechos que varían de un estado a otro.

Nuestros productos vienen con garantías que no se pueden excluir bajo la Ley Australiana del Consumidor. Usted tiene derecho a recibir un reemplazo o reembolso por un fallo grave y compensación por cualquier otra pérdida o daño razonablemente previsible. También tiene derecho a la reparación o el reemplazo de los bienes si los bienes no son de calidad aceptable y el fallo no supone un fallo grave.

TODOS LOS RECLAMOS DE GARANTÍA DEBEN ESTAR ACOMPAÑADOS POR UN RECIBO DE COMPRA. REPORTE LOS DEFECTOS DEL PRODUCTO POR ESCRITO A:

LIFETIME PRODUCTS, INC.,
PO Box 160010
Freeport Center, Bldg. D-12
Clearfield, UT 84016-0010

Para realizar reclamos de garantía por internet, visite: www.lifetime.com/warranty.

Departamento de Garantías: (800) 225-3865 L-V de 7 a. m. a 5 p. m. Zona horaria de la montaña (Mountain Standard Time, MST).

PARA LA GARANTÍA INTERNACIONAL:

Todos los reclamos de garantía deben estar acompañados por un recibo de compra. Reporte los defectos del producto por escrito a su representante regional de apoyo de ventas. Por favor, incluya su recibo de compra con la fecha y fotografías de las piezas dañadas.

Para identificar al representante de su región, por favor visite: www.lifetime.com/international

ENHANCE YOUR LIFETIME® PURCHASE BY ADDING ACCESSORIES OR OTHER GREAT PRODUCTS

To purchase accessories or other Lifetime® products, visit us at:

www.lifetime.com

Or call: 1-800-424-3865

7:00 am–5:00 pm (M–F) MST and 9:00 am–1:00 pm Saturday MST

AMÉLIORER L'ACHAT LIFETIME® EN AJOUTANT DES ACCESSOIRES OU D'AUTRES PRODUITS

Pour acheter des accessoires ou des autres produits Lifetime®, visiter le :

www.lifetime.com

Ou composer le 1-800-424-3865

Du lundi au vendredi de 7 h à 17 h, HR et le samedi de 9 h à 13 h, HR

MEJORAR LA COMPRA DE LIFETIME® AGREGANDO ACCESORIOS U OTROS MARAVILLOSOS PRODUCTOS

Para comprar accesorios u otros productos de Lifetime®, visitarnos en:

www.lifetime.com

O marcar al 1-800-424-3865

De lunes hasta viernes 7:00 h–17:00 h Horario Éstandar de la Montaña (MST) y sábados 9:00 h–13:00 h (MST)



www.lifetime.com

