

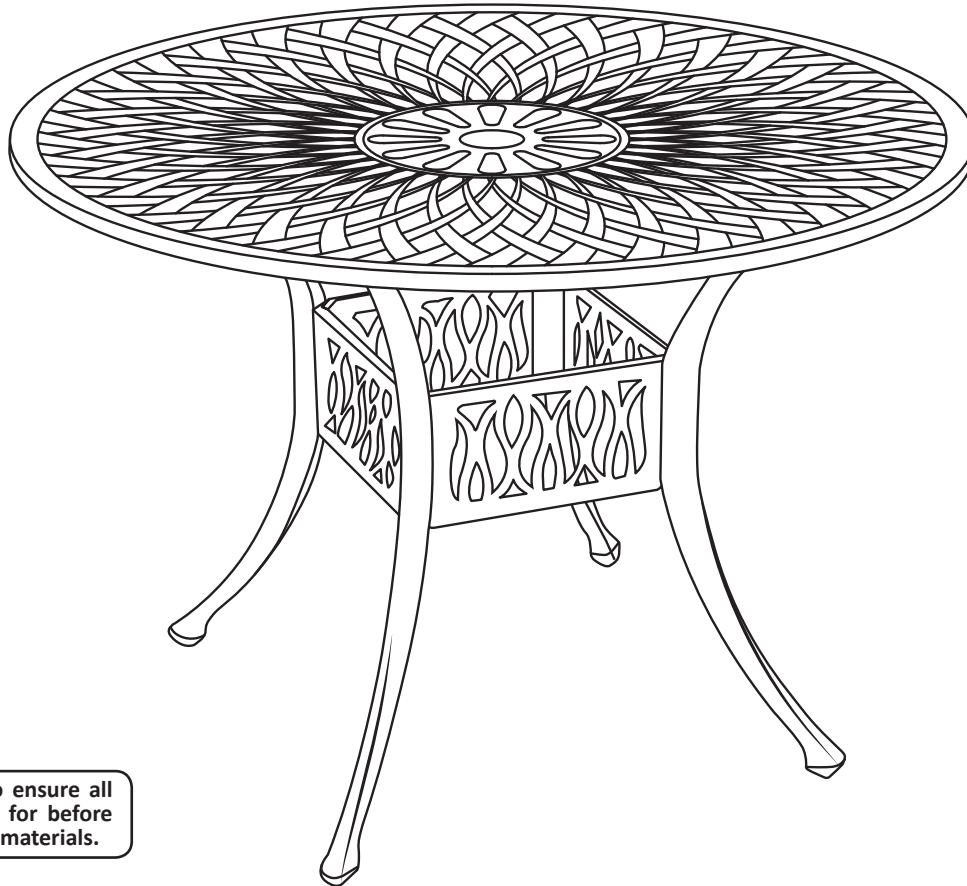









# SIGONELLA CAST ALUMINUM TABLE

## YUK-267

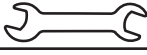
Read the assembly instructions carefully and follow the care instructions. Save this document for future reference.  
**Assemble on a soft, clean surface to avoid scratching or damaging the finish.**

Inspect packaging to ensure all parts are accounted for before disposing of packing materials.

No.	PARTS		QTY.
A		Leg	4
B		Panel	4
C		Tabletop	1
D		Spanner	1
E		M8x35mm Grub Screw	12
F		Flat Washer	12
G		Split Washer	12
H		Nut	12
I		Hex Key	1

**⚠ WARNING ⚠**  
**CHOKING HAZARD** — This item contains small parts that can be swallowed by children. Keep children away during assembly.

**! HELPFUL HINT**  
 Sunnydaze Decor advises reading this manual fully, and assembling the item soon after purchase. Check that all parts are accounted for and familiarize yourself with the assembly before beginning.

# ASSEMBLY

**! IMPORTANT !**

**Each side of Panel (B) is different.**

**Pay attention to installation direction to ensure panels align correctly.**

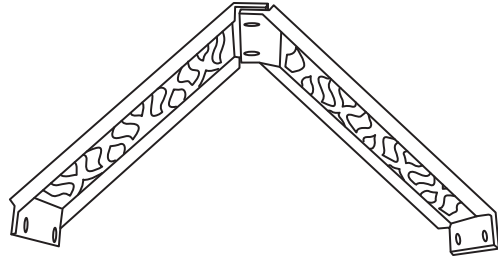
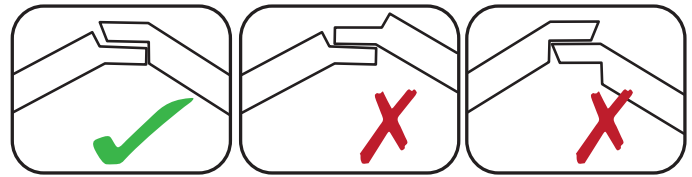
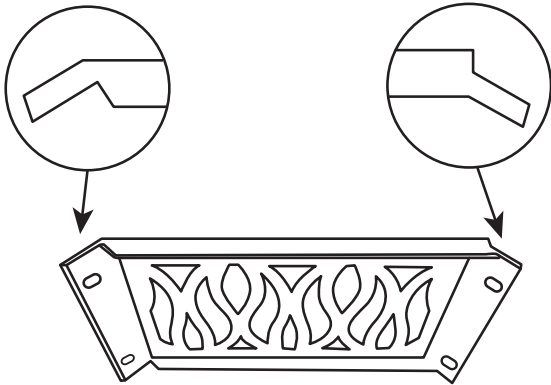

## STEP 1

A: 4

E: 8

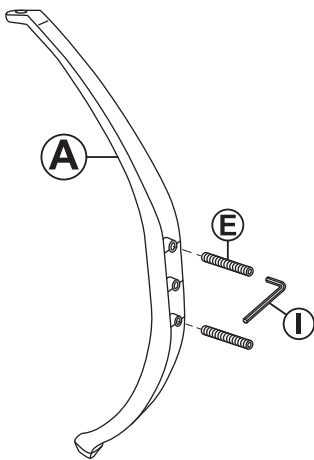

- Firmly secure 2x Grub Screws (E) into Leg (A) using Hex Key (I).
- Repeat this step for remaining three legs.

## STEP 2

B: 2

F: 4

G: 4

H: 4

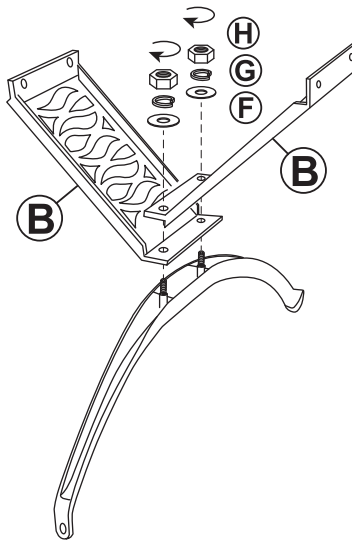

- Align 2x Side Panels (B) as shown in the diagram at the top of this page.
- Secure the overlapping side panels to the grub screws on one of the legs using two sets of Flat Washer (F), Split Washer (G) and Nut (H).

Do not tighten hardware until Step 6 is complete.

## STEP 3

A: 1

B: 1

F: 2

G: 2

H: 2

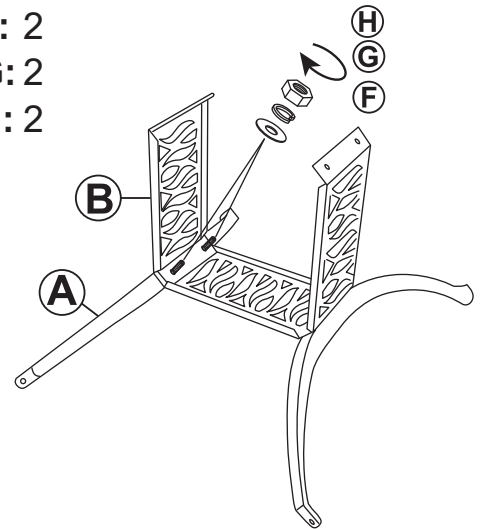

- Ensure the third Side Panel (B) is correctly aligned with a side panel from Step 1.
- Before securing the second leg, check that the top and bottom are installed in the same direction as the first leg.
- Secure the overlapping side panels to the grub screws on Leg (A) using two sets of Flat Washer (F), Split Washer (G) and Nut (H).

Do not tighten hardware until Step 6 is complete.

## STEP 4

A: 1  
B: 1  
F: 4  
G: 4  
H: 4

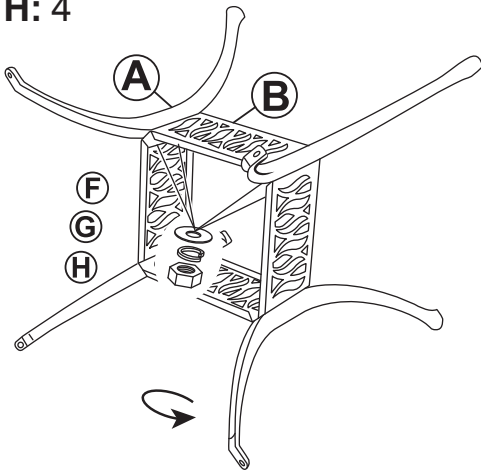

- Ensure the last Side Panel (B) is correctly aligned, and Legs (A) are in the right direction.
- Secure the legs to the side panels using four sets of Flat Washer (F), Split Washer (G) and Nut (H).

Do not tighten hardware until Step 6 is complete.

## STEP 5

C: 1  
E: 4

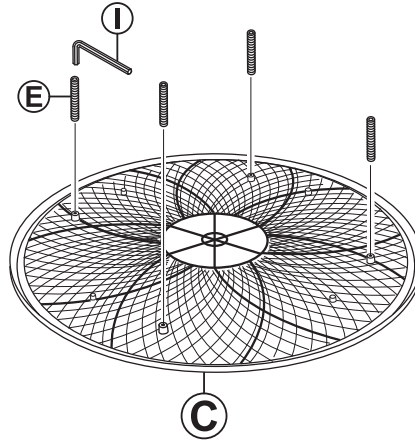

- Place Tabletop (C) face-down on a clean, soft surface.
- Firmly secure 4x Grub Screws (E) into Leg (A) using Hex Key (I).

## STEP 6

F: 4  
G: 4  
H: 4

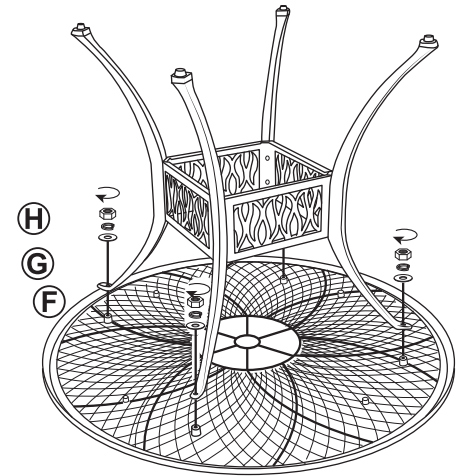

- Place the assembled base over the grub screws on the tabletop.
- Secure each leg using one Flat Washer (F), Split Washer (G) and Nut (H).
- Fully tighten all nuts, from all steps, using Spanner (D).

## STEP 7

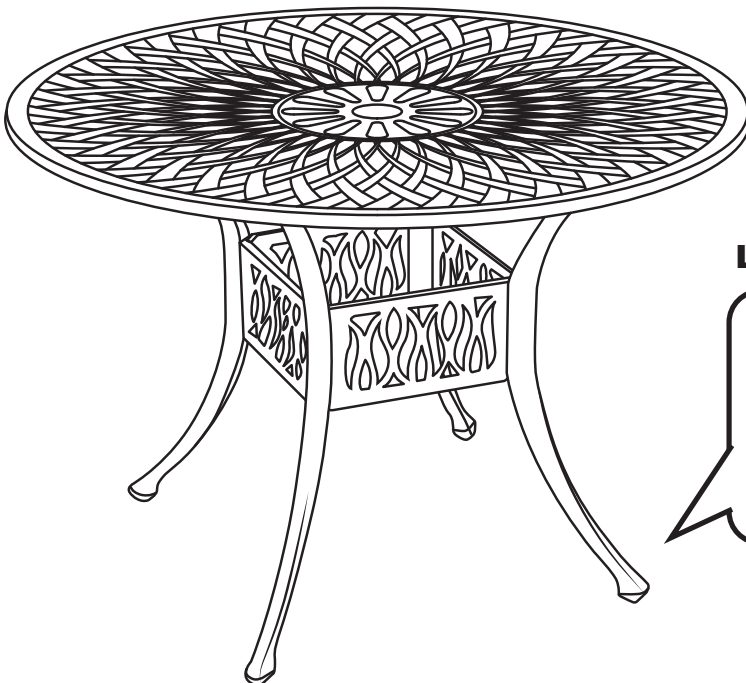

### Adjustable Leg-Leveling Feet

- If the table sits unevenly, simply turn the threaded feet slightly until balance is achieved.
- Please note, the adjustable leg-leveling feet are only effective on slightly uneven surfaces.

# Care & Maintenance

**SAFE USE:** For residential use only. Only use on a flat, level surface.

**INSPECT:** Periodically check assembly points and tighten fittings as necessary.

**COVER:** When not in use, cover furniture with a breathable cover to help protect it from the harmful effects of sunlight, inclement weather, as well as dust build-up, and collecting debris.

**WINTER CARE & STORAGE:** During winter and freezing temperatures, move the furniture to a cool, dry indoor location. Covering while in storage will help prevent dust build-up.

**SCRATCHES:** The powder-coating on this product is tough & durable but, even under normal use, some scratching is inevitable. Scratches can be repaired with a rust-resistant paint.

**WARNING: THE ONE-YEAR WARRANTY DOES NOT COVER DAMAGES OR DEFECTS CAUSED BY THE USE OF CHEMICAL TREATMENTS OR PROTECTIVE COATINGS.**

## Cleaning



HAND-WASH ONLY



DO NOT USE BLEACH



DO NOT USE A PRESSURE WASHER

Mix warm water with mild detergent. Use a soft cloth to hand-wash the furniture. Use a garden hose to thoroughly rinse away all soap residue. To prevent water spotting, dry with a soft, lint-free cloth.

### SAFETY STATEMENTS & WARNINGS

- Do not exceed the weight capacity of the furniture.
- Do not sit, stand, or climb on the table.
- Inspect hardware often and tighten loose hardware before use.
- Do not use harsh chemicals or abrasive materials to clean the furniture.

**Any modification to the product or failure to follow recommended care will void the product warranty.**

### WARNING!

Manufacturer and seller expressly disclaim any and all liability from personal injury, property damage or loss, whether direct or indirect, or incidental, resulting from the incorrect attachment, improper use, inadequate maintenance, or neglect of this product.