



Product Name:	Wood Victorian Console and Entry Table
SKU #:	WHIF788



Thank you for purchasing this Luxen Home product. This product has been manufactured with the highest standards of safety and quality.

PLEASE READ ALL INSTRUCTIONS BEFORE ASSEMBLY.

Unpack all parts from Styrofoam and bubble wrap inside the carton to ensure there are no missing or damaged parts. If any parts are missing or damaged, do not attempt to assemble or use the product.

CARTON CONTENTS:

A		1PC
B		2PCS
C		2PCS

1		8PCS
2		8PCS
3		1PC

ASSEMBLY INSTRUCTIONS:

To assemble the legs, first place the table upside down on a soft surface to avoid scratches.

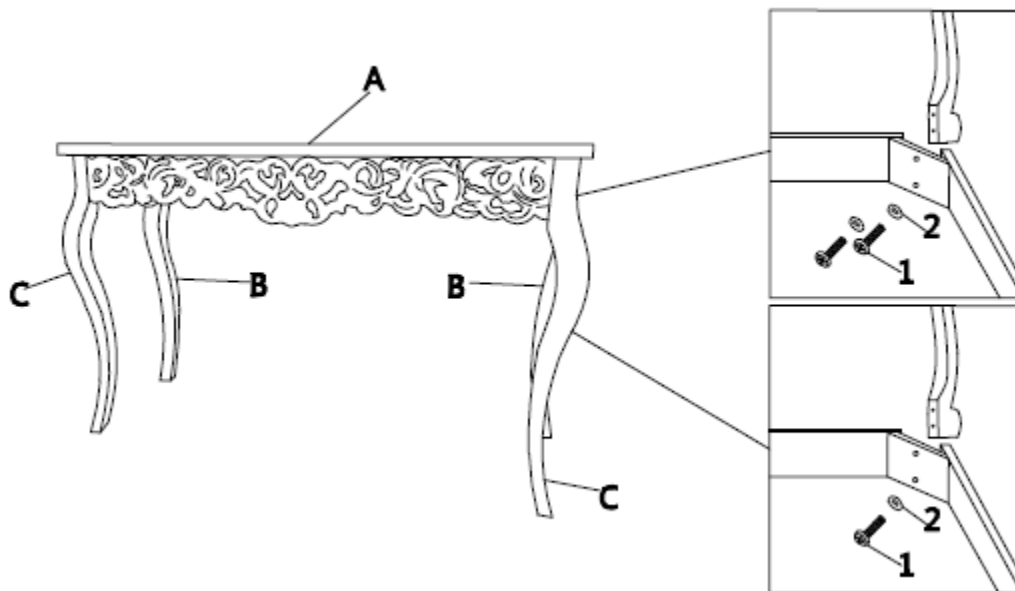

Product Name:	Wood Victorian Console and Entry Table
SKU #:	WHIF788

Completed table:

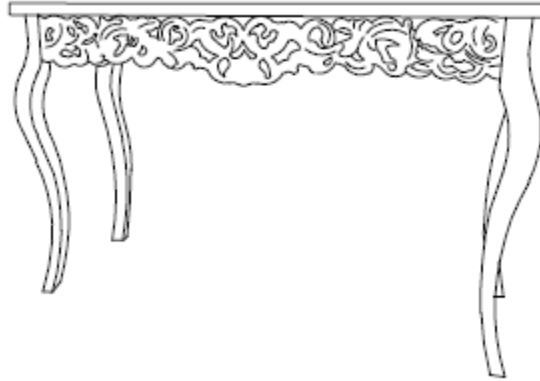

 **Warning:** DO NOT sit or stand on the table as this may damage the product and cause serious bodily injury.