



10375 State Route 43
Streetsboro, OH 44241

Phone: 800.866.2161
Fax: 330.562.7403

www.powerwizardinc.com

INST-04-0003-00 0092 Rev. 12-09

Electric Fence Energizer

Installation, Operating and Warranty Instructions

WARNING:

**READ ALL INSTRUCTIONS BEFORE INSTALLATION.
SAVE THIS BOOKLET FOR FUTURE REFERENCE.**

SAFETY INFORMATION

Warning: Read All Instructions
Attention: Lire Toutes Les Instructions

Warning: Save These Instructions
Guardar estes instucoes



DANGER – DOUBLE INSULATED: when servicing, use only identical replacement parts and by qualified service personnel only. Double insulated energizers include two systems for insulation.



CAUTION

CAUTION: To reduce the risk of electrical shock do not remove cover. Refer to service personnel.

Afin de reduire les risques d'electrocution, ne retirez pas le couvercle. Adressez vous au personnel de service.

WARNING: Do not connect simultaneously to a fence and any other device such as a cattle trainer or a poultry trainer. Otherwise, lightning striking your fence will be conducted to all other devices.

AVERTISSEMENT: *ne pas raccorder siultanement a une cloture et a un au-*

SOLAR ENERGIZER MAINTENANCE

- Check the energizer regularly to insure operation is normal.
- Clean the surface of the solar panel regularly. Use a soft, damp cloth. Do not use abrasive materials that could scratch the panel.
- Set the toggle switch in the “OFF” position when not using the energizer for more than 5 days. This prevents overcharging of the battery.
- DO NOT use any means for charging the internal battery except for the solar panel or a constant potential current limited 12VDC battery charger (Power Wizard Part No. F-2) rated at 500 milliamps maximum.
- When storing the energizer, place the energizer in strong direct sunlight for 2 days every 3 months with the switch in the “CHARGE” position. Put switch back into the “OFF” position for storage.

WARNING: SAVE THESE INSTRUCTIONS
GUARDAR ESTES INSTUCOES

tre dispositif tel qu'un enclos de dressage du betail ou un poste de conditionnement de la volaille. Sinon, si la foudre frappe la cloture, le courant de la foudre sera transmis au dispositi.

To reduce the risk of electric shock, an ac line operated fence controller has a polarized plug (one blade is wider than the other). The plug will fit in a polarized outlet only one way. If the plug does not fit fully in the outlet, reverse the plug. If it still does not fit, contact a qualified electrician to install the proper outlet.

Afin de reduire les risques d'electrocution, un controleur de cloture alimente sur ligne ac est muni d'une prise polarisee (un lame est plus large que l'autre). Cette pris s'emboite dans une sortie polarisee que d'une maniere. Si la prise ne s'engage pas totalement dans la sortie, inversez la prise. Si elle ne s'engage toujours pas, contactez un electricien qualifie pour installer une sortie appropriee. Ne changez la prise en aucune maniere.

This fence controller is not to be permanently mounted using conduit.

ADDITIONAL SAFETY GUIDELINES - PLEASE READ CAREFULLY:

1. **CAUTION: RISK OF ELECTRIC SHOCK.** Do not install where small children, the elderly or unhealthy persons may come in contact with the live portions of electric fencing. Use electric fence warning signs wherever humans may come in contact with the fence.
2. **NEVER** electrify barbed wire or loose fencing materials that risk entanglement of a human or animal. Exposure to continuous or multiple shocks is very dangerous.
3. **STAY AWAY** from the fence energizer and from the fence line just before and during lightning storms. In lightning prone areas, disconnect the energizer from the fence and from the power supply in advance of storms to prevent damage to the energizer.
4. **FOLLOW** all national, state and local regulations that may apply to installation of electric fence in your area.
5. **REFER TO AUTHORIZED REPAIR CENTER FOR SERVICE.** There are no user serviceable parts. Never alter the design of the energizer. Doing so is hazardous and will void the warranty.
6. **ALWAYS** unplug the energizer before handling any part of the energizer.
7. **NEVER** put more than one energizer on a fence. Doing so is dangerous because it may reduce time off between pulses, may damage the energizer and will invalidate the warranty.

vegetation, buildings and roof overhangs will not block sunlight from the panel.

- A. A fully charged battery will operate the energizer for up to 18 days in darkness before the energizer will stop. At this point, the battery is almost completely discharged.
 - B. A fully discharged battery will require 20-25 hours of recharging with the solar panel in strong sunlight before operating the energizer. On average, 6-8 days of charging in sunlight will restore a fully discharged battery. Recharge battery with the toggle switch in the "CHARGE" position.
5. Upon completion of battery charging, the energizer is ready to be installed on the fence. Locate energizer so that solar panel is facing due south into the sun at its highest point at 12:00 noon. Select a location where solar panel will never be shaded from the sun. Locate the energizer out of reach of animals and children. Secure the energizer so that solar panel will not move away from the sun.
 6. Connect fence and ground wire to labeled terminals and move toggle switch to "ON" position. Red light will flash when energizer is operating.

SUPPLEMENTAL INSTRUCTIONS FOR BATTERY POWERED ENERGIZERS

1. Use a Deep Cycle Rechargeable Battery rated at 60 amp hour or greater. Marine batteries are recommended.
2. Avoid placing battery directly under energizer so that corrosive gases will not damage the energizer. Locate the battery in a cool and dry area for best performance.
3. Place the battery away from sparks and in a well-ventilated area for safety. Check battery voltage and energizer performance regularly to ensure continuous operation.

SUPPLEMENTAL INSTRUCTIONS FOR SOLAR CHARGED ENERGIZERS

1. Remove all labels from front of solar panel and clean panel with a damp cloth.
2. Make sure that the lead wire running from the solar panel is connected to the fence energizer.
3. Put toggle switch in the "CHARGE" position.
4. **IMPORTANT: BEFORE INSTALLING ENERGIZER ON THE FENCE LINE,** mount energizer upright in a location outdoors that will receive the maximum available direct sunlight for a minimum of 4 days. Face the energizer due south, into the sunlight. Energizer should be in a location where trees,

8. **DO NOT** run fence wire above ground near high voltage power lines. If too close, the electric fence may pick up dangerous levels of power from high voltage lines. Never cross under a high voltage line with electric fence.
9. **ALWAYS** maintain an adequate ground system securely attached to the energizer.
10. **DO NOT** alter the polarity of the energizer plug on 110V operated energizers. For battery operated fence energizers, connect the red battery clamp to the positive battery terminal and the black battery clamp to the negative battery terminal only.
11. **NEVER** charge a battery that is connected to a fence energizer. Always disconnect the battery from the energizer first.
12. **WARNING!** Electric fences are very effective psychological barriers when properly installed and when animals are trained to the fence. Electric fences are **NOT** complete physical barriers. Erratic animal behavior cannot be predicted and occasional fence penetration can occur. Therefore, Power Wizard assumes no liability for animal containment, injury or the consequences for the misuse of the equipment.
13. **WARNING!** Never touch the live fence with the head or mouth.
14. **WARNING!** Sparks may occur in electric fence systems. Therefore, during periods of high fire risk, electric fence energizers should be turned off.

HOW DOES THE ELECTRIC FENCE WORK?

The fence energizer puts a high voltage pulse of electric energy on the fence wire at 1 to 2 second intervals. In ideal conditions the energizer, the electric fence and the ground wire form an incomplete circuit. When an animal comes into contact with the fence while standing on the ground, the electric circuit is completed. Electrons immediately flow through the animal's body from fence wire to ground. This is experienced as a shock. The shock will only be respected and repel the animal if the voltage and energy in the pulse are at adequate levels. Voltage and energy levels in the pulse are determined by the capability of the fence energizer, the condition of your fence and the quality of the ground system. Generally, a minimum of 2,000 volts must be maintained on the fence line to repel most animals. Many animals require several shock experiences before they are fully conditioned with lasting respect for the fence.

law specifically precludes this disclaimer. The manufacturer and seller shall have no liability for damages, incidental or consequential, resulting from or caused by any failure, malfunction or defect of any product.

The sole obligation of Power Wizard, Inc. shall be limited to repair or replacement, at its option, of the defective fence energizer or part.

TO MAKE A WARRANTY CLAIM

1. First disconnect energizer from fence and confirm that voltage output at the energizer terminals is not normal.
2. Before returning product under warranty, you must call Power Wizard at (800) 866-2161 to obtain a Return Goods Authorization number and a shipping address for the service center that will process the return. The RGA number must accompany the returned product.
3. Attach a note showing your name, phone number, return address and brief description of the problem.
4. Pack product carefully in oversized carton with crushed newspaper for cushioning.
5. Your product should be shipped prepaid and insured against shipping loss or damage.

POWER WIZARD WARRANTY

30 DAY SATISFACTION GUARANTEE

POWER WIZARD, INC. guarantees your complete satisfaction with this fence energizer. If you are not satisfied with this product, you may return the energizer to the original place of purchase within 30 days of purchase for a full refund. Proof of purchase is required for a full refund.

LIMITED WARRANTY

POWER WIZARD, INC. warrants this fence energizer to the original purchaser for a period of thirty-six (36) months from the date of purchase, when installed and used in accordance with the enclosed installation instructions. You must retain your receipt for proof of purchase. This warranty covers defects in materials and workmanship to the fence energizer. The warranty also covers damage to the energizer caused by lightning and voltage spikes.

TERMS THAT APPLY TO BOTH THE GUARANTEE AND WARRANTY

Improper installation, misuse, neglect and tampering of any kind are NOT covered under the 30-Day Guarantee or the Limited Warranty. No warranty other than the above is expressed or implied. Implied warranties of merchantability and fitness for a particular application are hereby disclaimed unless the

KEYS TO SUCCESSFUL ENERGIZER INSTALLATION

Take care of the following details and you will prevent many hours of extra work.

1. Use the correct size energizer. It is best to select an energizer that will adequately power the most difficult fence conditions. This generally occurs during the peak growing season. Refer to the Power Wizard Energizer Selection Guide for proper energizer selection.
2. Carefully install a complete ground system. Most electric fence failures are caused by an improper ground system (see Diagram #1, pg. 12).
3. Take time to properly connect lead out wire, ground wire and fence line splices. This is the second most common cause of electric fence failure. Use clamps, split bolts and taps for securing wire connections. Make sure all connection surfaces are of bare, shiny metal (see Wire Splice and Connections Diagram, pg. 22).
4. Use adequately insulated hook-up wire (rated for at least 20,000V) where the hot wire must travel underground. Never use standard household insulated wire, which is typically rated for only 600 volts or less.

- Maintain proper distances from buried and above ground: utility company ground rods, water pipes, metal siding, telephone wire and stock watering tanks (see Diagram 1 on pg. 12 for ground and Diagram 2 on pg. 15 for fence).
- Use an electric fence volt meter to periodically check the condition of your fence and to troubleshoot connections and ground conditions.
- Finally, it is very important that an animal's first experience with an electric fence shock is one of respect. Some animals require more than one shock experience for lasting respect of the fence line. Always train the animal to the fence prior to unsupervised entry into pastures by insuring that the animal's first approach to the fence is slow, without stress and that an effective repelling shock is experienced.

This result indicates that there is a high resistance on the fence line. This can be caused by poor wire connections, wire breaks, wire to small, rusty wire and corrosion from using dissimilar metal contacts. Using the Digital Volt Meter, start near the Energizer and measure the voltage at regular intervals (approximately every 50 yards) as you walk away from the Energizer. When a voltage drop is detected, the problem is located in the last section tested. Look for faulty wire connections and rusty wire. Follow "Wire Connections and Splicing Diagram" (pg. 22) in Installation Guide to repair connections. Replace rusted wire. Wire connections should be made only with shiny wire. Continue repairs until voltage on entire fence is GREATER THAN 3,000 Volts.

Connect branch runs of fence one at a time until voltage drop is detected. Repair this run of fence. Replace cracked Insulators, Cut away excess vegetation growth, Remove any material contacting fence wire that comes into contact with the earth. Make sure wire is not touching any fence material with the exception of good quality insulators. Look carefully at Gates & Corners. Make certain that any underground sections are insulated to 20,000 Volts and replace old insulating material. After repairing this section, continue connecting branch runs until entire fence maintains a voltage GREATER THAN 3,000 Volts. Fence will now turn back most animals.

Repair this run of fence. Replace cracked Insulators, Cut away excessive vegetation growth, Remove any material contacting fence that can come into contact with the earth. Make sure wire is not touching any fence material with the exception of good quality insulators. Look carefully at Gates & Corners. Make certain that any underground sections are insulated to 20,000 Volts and replace old insulating materials.

Troubleshooting Guide

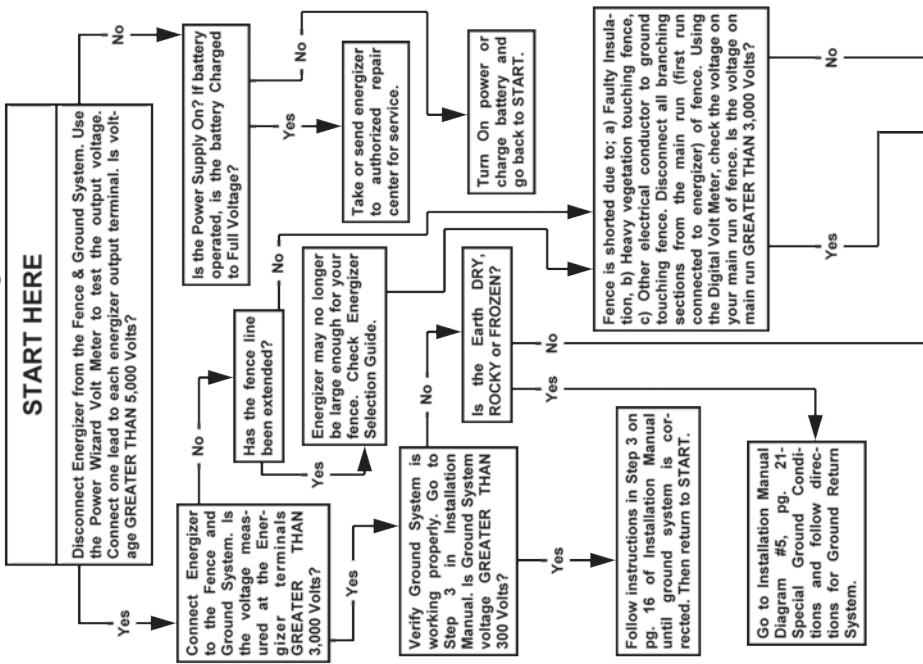

INSTALLING YOUR NEW ENERGIZER

BEFORE YOU START

TOOLS NEEDED

1. Screwdriver – for mounting energizer, cut-off switch and lightning choke
2. Wire cutters – to cut and strip insulation
3. Post driver – to install ground rods
4. Digital volt meter – for electric fence testing and troubleshooting

ACCESSORIES NEEDED

1. At least three galvanized ground rods – minimum 6 feet by 1/2" (minimum) diameter
2. Three ground rod clamps
3. Insulated underground hook-up wire – 50 feet (20,000V rating)
4. One energizer cut-out switch
5. Line clamps
6. One lightning choke and one lightning diverter or a combination choke and diverter
7. One surge protector (for AC-powered energizers only)

INSTALLATION STEP 1

INSTALLING THE GROUND SYSTEM

The "ground system" is a series of highly conductive rods driven into the soil and then connected by wire to the ground terminal of your fence energizer. The ground system collects electrons from the soil to complete the circuit needed for delivering an effective shock.

1. Locate an area of soil for placing ground rods that contains good conductive earth (not sandy or rocky). Soil that is moist throughout the year is best. The ground system should be located within 75 feet of your fence energizer and at least 25 feet from buildings.
2. Locate ground system a minimum of 75 feet away from:
 - a. Utility company (electric, gas, water) ground system.
 - b. Underground water pipe
 - c. Metal water tanks
 - d. Metal siding on building (minimum 25 ft. away)

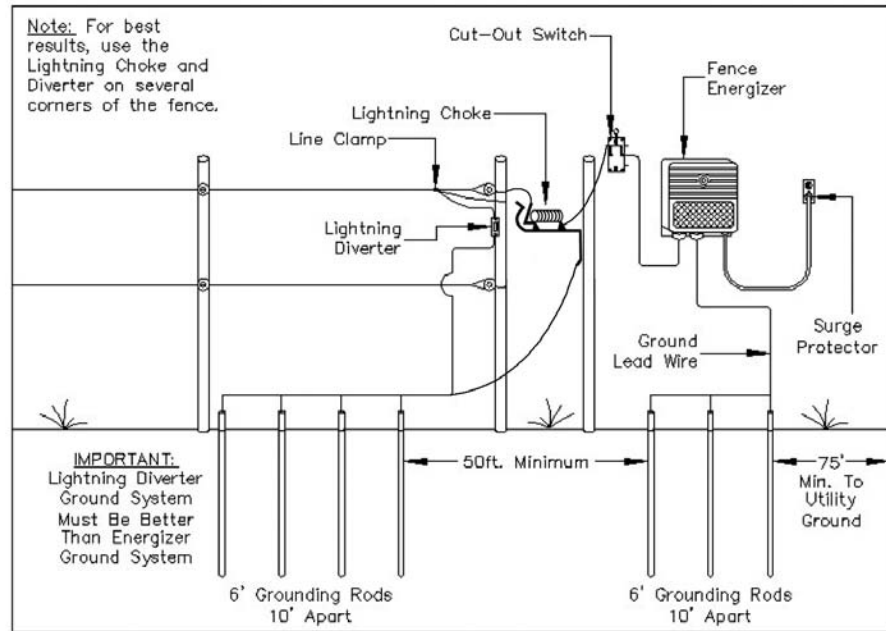

Diagram 7 – Protecting Your Fence Energizer From Lightning

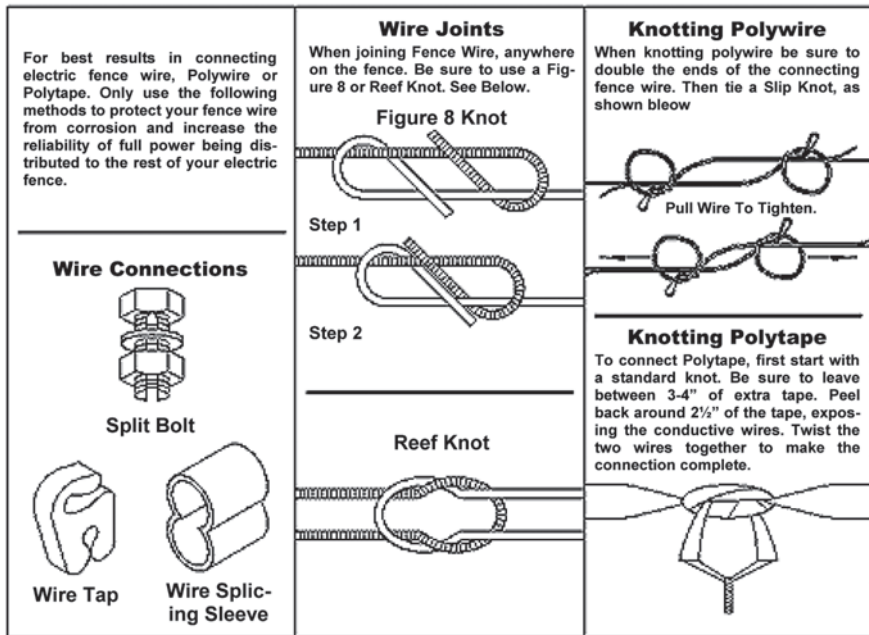

Diagram 6 – Wire Splicing and Connections

3. Drive three 6 foot by 1/2" (minimum) galvanized ground rods 10 feet apart in a straight line or a triangle pattern in the selected ground area. Leave 6 inches above the ground for securing ground clamps. Mark the area as a hazard.
4. Connect the ground rods, in a series, with one piece of continuous 10 to 14 gauge galvanized wire. The ground hook-up wire should be equal to or larger than the diameter of the fence line wire.

See Diagram on Next Page

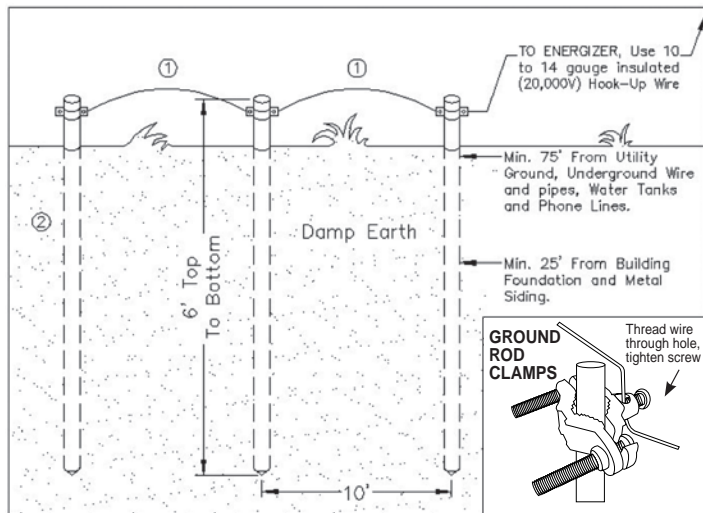

Diagram 1 – Ground System Installation

1. 12-14 gauge galvanized fence wire.
2. Ground rods – 6 feet long by 1/2" (or more) in diameter, galvanized steel rods.

IMPORTANT: Avoid SANDY, DRY and ROCKY soil.

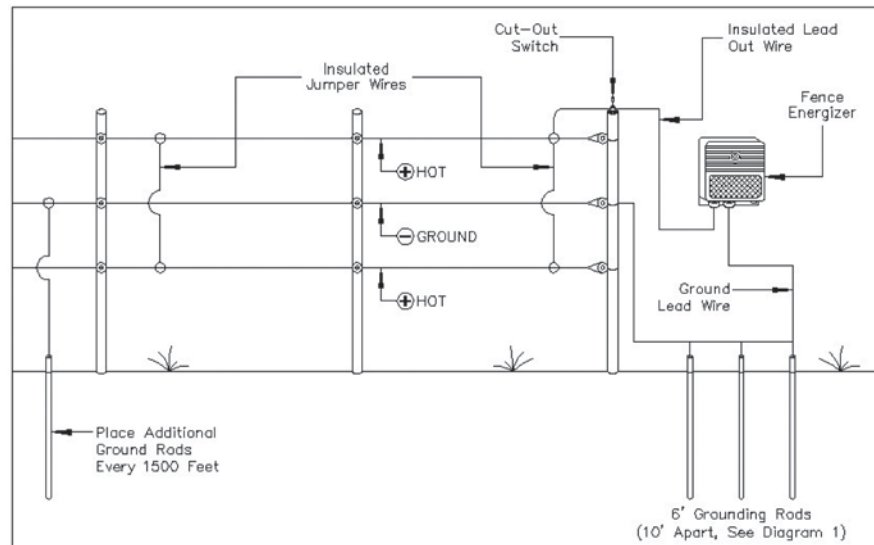
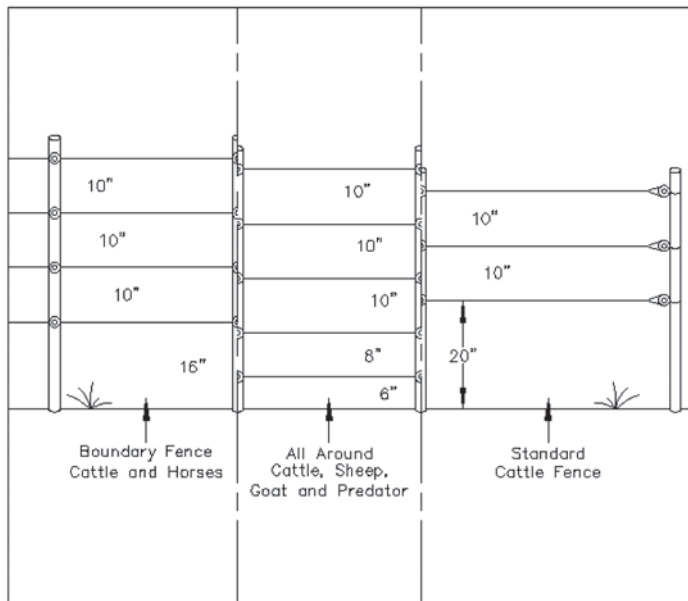

Diagram 5 – Ground Return System

For Drier Climates, Hard-to-Control Animals, Sandy Soil, Frozen Ground and Snow-Covered Ground



**Diagram 4 – Standard Multi-Wire Systems
Wire Spacing for Different Animals and Applications**

INSTALLATION STEP 2

INSTALLING THE FENCE ENERGIZER

1. Locate the energizer within 75 feet of your ground system. Use only polarized extension cords. Mount the fence energizer:
 - a. At eye level and out of the reach of small children and livestock
 - b. Protected from weather and moisture
 - c. Away from all flammable materials and gasses in a well-ventilated area.
2. Before connecting the “fence” and “ground” energizer terminals, plug in or “power on” the energizer and check the output voltage at the terminals with an electric fence volt meter (use only voltmeters designed for this purpose). Record the voltage as a benchmark for future reference. You should see the indicator light flashing and hear a “click” at 1 to 2 second intervals.

- UNPLUG OR TURN THE FENCE ENERGIZER OFF and then connect the "GROUND" terminal to a 10 to 14 gauge insulated lead-out wire (rated at 20,000V). The lead-out wire is also known as a "hook-up" or "underground fence wire". Connect the opposite end of the wire to the closest ground rod using a ground clamp and shiny bare metal contact surfaces. Then, connect the "FENCE" terminal to a 10 to 14 gauge insulated lead-out wire (rated at 20,000V) and connect the opposite end to a fence "cut-out" switch located on the first fence post.
- Plug the fence energizer in and measure the voltage at the "cut-out" switch before and after activating the fence. Record these voltage measurements for future use as a reference when checking the fence connection.

See Diagram on Next Page

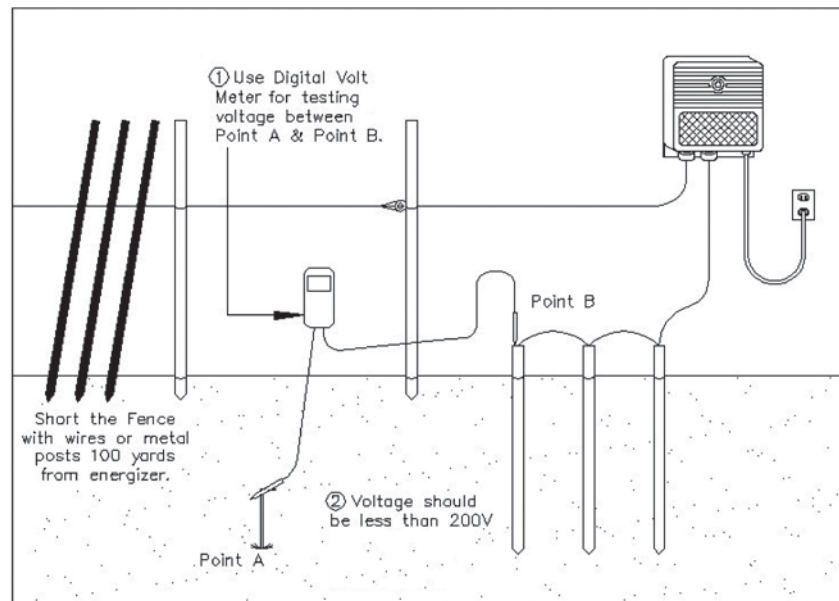

Diagram 3 – Testing the Ground System

INSTALLATION STEP 3

VERIFY THAT YOUR GROUND SYSTEM IS WORKING

The quality of your ground system is vital to maximizing the performance of your fence energizer. During dry seasons or during seasons when there is excessive growth or vegetation on the fence line, it may be necessary to upgrade your ground system with extra ground rods.

To test the quality of your ground system:

1. Unplug your fence energizer.
2. Place the fence under heavy load by “shorting” the fence as follows. At a location on the fence at least 100 yards from the energizer, lean 3 or 4 steel stakes or T-posts against the “hot” wire of the fence. Alternatively, you may push several pieces of fence wire into the earth and wrap the opposite ends around the hot wire.
3. Plug the energizer in and check the fence line voltage with a digital volt meter. You want to see that the voltage has dropped below 2,000V due to

shorting the fence. Continue to short the fence by leaning steel posts or by making wire connections to ground at 100 yards distance or more from energizer until the fence line voltage drops below 2,000V.

4. You are now ready to test the energizer ground system. Connect one lead of the digital volt meter to a 12 inch metal stake driven into the ground 3 feet away from the last fence energizer ground rod. Connect the second lead to the ground rod furthest from the energizer. The voltage reading should ideally be zero or no more than 200V.
5. If the digital volt meter reading is under 200V, your ground system is adequate and you will get near maximum performance from your electric fence energizer.
6. If the reading is above 200V, then your ground system needs improvement. You must:
 - a. Add more ground rods connected in series, 3 feet apart.

and/or