



Kit Trailer Assembly Instructions

Model: 48-048-KO8, 48-072-KO8/KO12

48-096-KO8 & 60-096-KO12

Carefully read and follow the assembly instructions in this manual.
Before using the trailer, carefully read the owner's manual.
Save both manuals for future reference.

Video Assembly Instructions Available at
<https://www.youtube.com/c/WestbrookTrailers>



***Congratulations on the purchase of your kit trailer.
Thank you for choosing Westbrook Trailers.***

Safety Information



- It is important to read and understand all the instructions. Failure to follow all assembly instructions may result in serious injury.
- **The edges of the trailer frame can be sharp, it is IMPORTANT to ALWAYS** wear the provided safety gloves when handling the material during unboxing and the assembly process.
- **It is recommended that you use two people to assemble** your trailer since you will need to turn the trailer during the assembly.
- **Modification of the trailer structure can make the trailer unsafe and void your warranty.** Any modifications made to the trailer must comply with DOT and NHTSA regulations and must not compromise the gross vehicle weight rating (GVWR) of the trailer.

Important Information

The paperwork needed to register your trailer is included in your kit. These are key documents that must be submitted in order to register your trailer. They are enclosed in a brown envelope on the outside of box #1.

The VIN label and UV overlay, the NVIS document for Canadian customers, and the Certificate of Origin (Title) document for US customers will all be included.

If the questions regarding the NVIS or Certificate of Origin, please contact us at 866-857-1445.

Write the VIN of the trailer and the purchase date in the space below.

Keep this manual and your receipt in a safe and dry place for future reference.

Serial Number : _____

Purchase Date: _____

Unboxing your Trailer

The kit trailer is shipped in 3 boxes containing the following parts:

Make sure you have received all three boxes of the kit trailer. If any parts are missing or broken, please contact us at [866-857-1445](tel:866-857-1445) or email us at support@westbrooktrailers.com. When contacting us about your trailer, please have the VIN of the trailer and the purchase order number available.

4'x4' & 4'x6' & 4'x8'

- **Box # 1** - Includes tires, fenders, lights, small parts, and hardware. **Remove the registration documentation affixed outside this box and keep it in a safe place until you are ready to get a license plate.**
- **Box # 2** - Includes the axle and all the frame channels.
- **Box # 3** - Includes both axle springs.

5'x8'

- **Box # 1** - Includes tires, fenders, lights, small parts, and hardware. **Remove the registration documentation affixed outside this box and keep it in a safe place until you are ready to get a license plate.**
- **Box # 2** - Includes all the frame channels.
- **Box # 3** - Includes both axle and springs.



Item#500814
3/8 U-Bolt

Item#501049
3/8 x 3/4
Hex Flange Bolt

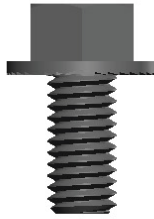

Item#501036
3/8 x 3/4
Carriage Bolt



Item#501023
3/8 x 2-1/2
Hex Bolt



Item#501024
3/8 x 3
Hex Bolt

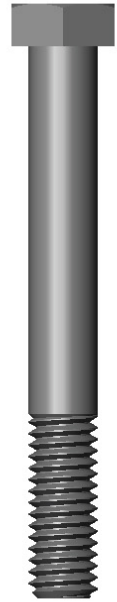

Item#501033
3/8 x 1-1/2
Hex Bolt



Item#501031
3/8 Locking Nut



Item#501032
3/8 Flat Washer

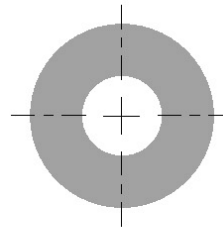

Item#501060
1/2 x 3-1/2
Hex Bolt



Item#501065
9/16 x 3 UNF
Hex Bolt



Item#501056
1/2 Locking Nut



Item#501066
9/16 UNF
Locking Nut



Item#501001
1/2" Wheel Nut



Item#501091
#10 x 1/2 Phillips
Machine Screw



Item#501092
#10 Locking Nut



Item#501100
5/16 x 1/2
Cutting Screw



Item#501073
1/4 x 3/4
Hex Bolt



Item#501081
1/4 Nylon Insert
Locking Nut



Part Listing

BOX # 1 TIRE & FENDER (INCLUDES ITEM LIST IN THE THREE BOXES INSIDE THE TIRE BOX)

ITEM#	ITEM DESCRIPTION	4' x 4'	4' x 6'	4' x 8'	5' x 8'
500258	8" FENDER -	2	2	2	
500841	4.80 X 8 LRC TIRE & WHEEL	2	2	2	
504212	12" FENDER				2
500844	4.80 x 12 LRC TIRE ASSEMBLY				2

BOX # 1 - INTERIOR BOX - LIGHTS

500513	TAILLIGHT LEFT/DRIVER SIDE	1	1	1	1
500514	TAILLIGHT RIGHT/PASSENGER SIDE	1	1	1	1
500515	AMBER MARKER LIGHT	2	2	2	2
500516	PLASTIC LICENSE BRACKET	1	1	1	1
500512	4 WAY FLAT 20' WIRE HARNESS	1	1	1	1

BOX # 1 - INTERIOR BOX - METAL

	FENDER PLATE - 8" (504447) / 12" (504476)	2	2	2	2
504198	TONGUE SUPPORT FOOT	1	1	1	1
504471	STAKE POCKET	8	8	8	8
500259	LEAF SPRING MOUNTING BRACKET	4	4	4	4
500260	LEAF SPRING AXLE MOUNT PLATE	2	2	2	2
504162	5' TONGUE CONNECTION BRACKET	1	1	1	1
504163	LONG COUPLER CHANNEL	1	1	1	1

BOX # 1 - INTERIOR BOX - HARDWARE (below show the hardware needed to assembled, maximum QTYs are pkg in each kit)

500814	3/8" U-BOLT	4	4	4	4
501049	3/8" X 3/4" HEX FLANGE BOLT	20	18	26	26
501033	3/8" X 1 1/2" HEX BOLT	10	13	20	20
501036	3/8" X 3/4" CARRIAGE BOLT	8	8	8	8
501031	3/8" HEX FLANGE LOCK NUT	46	46	61	61
501023	3/8" X 2-1/2" HEX BOLT	1	1	1	1
501024	3/8" X 3" HEX BOLT	2	2	2	2
501032	3/8" FLAT WASHER	8	4	4	4
501060	1/2" X 3 1/2" HEX BOLT	2	2	2	2
501056	1/2" LOCKING NUT	2	2	2	2
501065	9/16 UNF X 3" HEX BOLT	4	4	4	4
501066	9/16 UNF LOCKING NUT	4	4	4	4
501091	#10 X 1/2" PHILLIPS #2 SCREW	8	8	8	8
501092	#10 LOCKING NUT	8	8	8	8
501100	5/16 X 1/2" CUTTING SCREW	4	4	4	4
501001	1/2" WHEEL NUT	10	10	10	10
501073	1/4 X 3/4" HEX BOLT	32	32	32	32
501081	1/4 NYLON INSERT LOCKING NUT	32	32	32	32
500805	1 7/8" COUPLER CLASS I	1	1	1	1
500804	SAFETY CHAIN - 3/16 X 4' (CLASS I)	1	1	1	1
503079	8" CABLE TIE	4	6	4	4
500558	WIRE CONNECTOR	2	2	2	2

Part Listing

BOX # 2 - FRAME BOX					
ITEM#	ITEM DESCRIPTION	4' x 4'	4' x 6'	4' x 8'	5' x 8'
500254	4' FRONT CHANNEL	1	1	1	
500255	4' CROSS CHANNEL	1	2	4	
500256	4' REAR CHANNEL	1	1	1	
504599	5' FRONT CHANNEL				1
504602	5' CROSS CHANNEL				5
504600	5' REAR CHANNEL				1
500251	4' DRIVER SIDE CHANNEL	1			
500297	4' PASSENGER SIDE CHANNEL	1			
500252	6' DRIVER SIDE CHANNEL		1		
500298	6' PASSENGER SIDE CHANNEL		1		
500253	4' FRONT DRIVER SIDE CHANNEL			1	1
500299	4' REAR DRIVER SIDE CHANNEL			1	1
500300	4' FRONT PASSENGER SIDE CHANNEL			1	1
500301	4' REAR PASSENGER SIDE CHANNEL			1	1
500272	CONNECTION CHANNEL (4X8)			2	2
500257	TONGUE CHANNEL FOR 4 FT WIDE TRAILER	2	2	2	
504601	TONGUE CHANNEL FOR 5 FT WIDE TRAILER				2
504162	5' TONGUE CONNECTION BRACKET	1	1	1	1
500047	4' STRAIGHT AXLE	1	1	1	
504623	TONGUE CROSS CHANNEL				1

BOX # 3 SPRING

ITEM#	ITEM DESCRIPTION	4' x 4'	4' x 6'	4' x 8'	5' x 8'
500809	750 LB. SLIPPER SPRING	2	2	2	2
504617	5' STRAIGHT AXLE				1

Assembly Instruction:

You will need to prepare a large area to work. To make the assembly process easier, the instructions have been divided into stages. Before beginning the assembly of each step, gather all of the parts specified and carefully read all of the instructions. Halfway through the installation, you will need to flip the trailer, which will require two people.

- Ratchet with Socket : 10mm, 3/8", 7/16" deep socket x 2, 1/2", 9/16", 13/16", 7/8"
- Wrench: 9/16", 3/4", 7/8"
- Phillips Screwdriver
- Torque Wrench
- Knife
- Pliers
- Gloves (included)
- QR Code for assembly



Video show assembly of 4' x 8' kit trailers, which includes most of the step for all other sizes

STEP 1- Stake Pocket Installation

ITEM #	DESCRIPTION	QTY
504471	STAKE POCKET	8
501073	1/4 X 3/4" HEX BOLT	32
501081	1/4 LOCKING NUT	32

1. Line the stake pocket to the pre-drilled holes of the frame and secure with 1/4 x 3/4 hex bolts and 1/4 lock nut using 7/16 deep socket. Do this for all eight stake pockets.

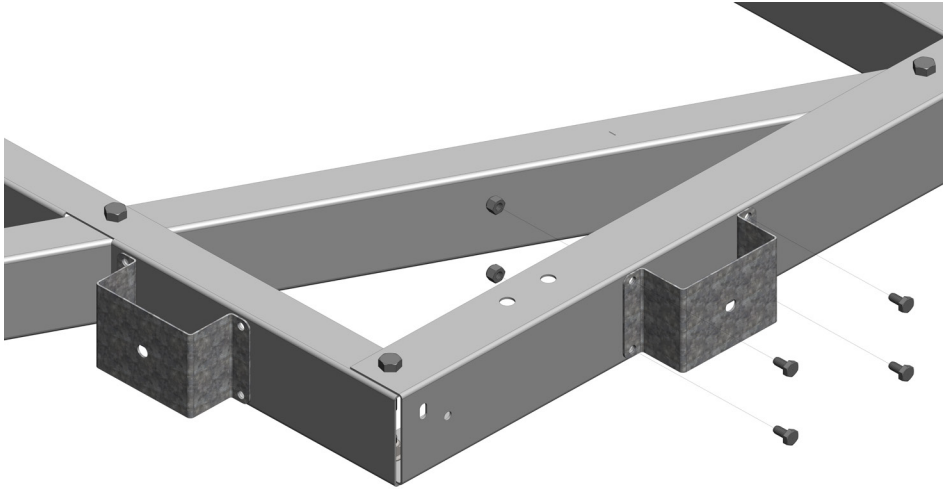

STEP 2 - Electrical Grommet installation

FRAME PIECES THAT REQUIRE GROMMET INSTALLATION					
ITEM#	ITEM DESCRIPTION	4' x 4'	4' x 6'	4' x 8'	5' x 8'
501171	ELECTRICAL GROMMET	4	8	12	14
500255	CROSS-CHANNEL	1	2	4	
504602	CROSS-CHANNEL				5
500257	TONGUE CHANNEL	2	2	2	
504601	TONGUE CHANNEL				2

1. Take one cross-channel and install the electrical grommet.
2. Repeat this for all **cross-channels**.



STEP 3a- Frame Assembly - 4'x 4' Kit Trailer Frame

ITEM #	PARTS DESCRIPTION	QTY
501049	3/8 X 3/4" HEX FLANGE BOLT	6
501033	3/8 X 1 1/2" HEX BOLT	6
501031	3/8 LOCK NUT	12
500254	FRONT CHANNEL	1
500255	CROSS CHANNEL	1
500256	REAR CHANNEL	1
500251	4' DRIVER SIDE CHANNEL	1
500297	4' PASSENGER SIDE CHANNEL	1
501171	ELECTRICAL WIRE GROMMET	2

IMPORTANT INFORMATION

- To avoid having to flip the trailer twice throughout the assembly, start with the frame **UPSIDE DOWN**.
- We recommend that you complete one side before moving on to the other side.
- **The longer hex bolts will be used to secure the plywood floor with frame.**
- **Assemble the frame but only tighten the hardware by hand, it will be tightened in a later step, otherwise you will not be able to complete the tongue installation.**

ASSEMBLY INSTRUCTION

1. Gather the frame pieces and the hardware placing them in their respective position as shown in **Figure 1**.
2. When placing your frame piece, **match the hole configuration** shown in Figure 1. For example, the passenger side channel **the square holes should be facing up**.
3. Both passenger and driver side channel overlaps with the front channel; **do not insert one channel inside the other.** (see Figure #1).
4. **Loosely** connect the first side channel using the $\frac{3}{8}$ x $\frac{3}{4}$ hex flange bolt and $\frac{3}{8}$ lock nut on the top, and the $\frac{3}{8}$ x 1 $\frac{1}{2}$ hex bolt and $\frac{3}{8}$ lock nut at the bottom. The $\frac{3}{8}$ X 1 $\frac{1}{2}$ bolts will be used to secure the plywood floor with frame. (Refer picture shows on side page)
5. Take a cross-channel and **loosely** connect it to the frame using the $\frac{3}{8}$ x $\frac{3}{4}$ flange bolt and $\frac{3}{8}$ lock nut on top and the $\frac{3}{8}$ x 1 $\frac{1}{2}$ hex bolt and $\frac{3}{8}$ lock nut at the bottom.
6. Repeat for other side.
7. Slide the rear channel over the passenger and driver's side channel and **loosely** connect using the $\frac{3}{8}$ x $\frac{3}{4}$ flange bolts and $\frac{3}{8}$ lock nuts on top, and the $\frac{3}{8}$ x 1 $\frac{1}{2}$ hex bolts and $\frac{3}{8}$ lock nuts at the bottom.

4'x 4' Kit Trailer Frame



The edges of the trailer can be very sharp.
To prevent injury, wear the provided safety gloves.

Figure 1.

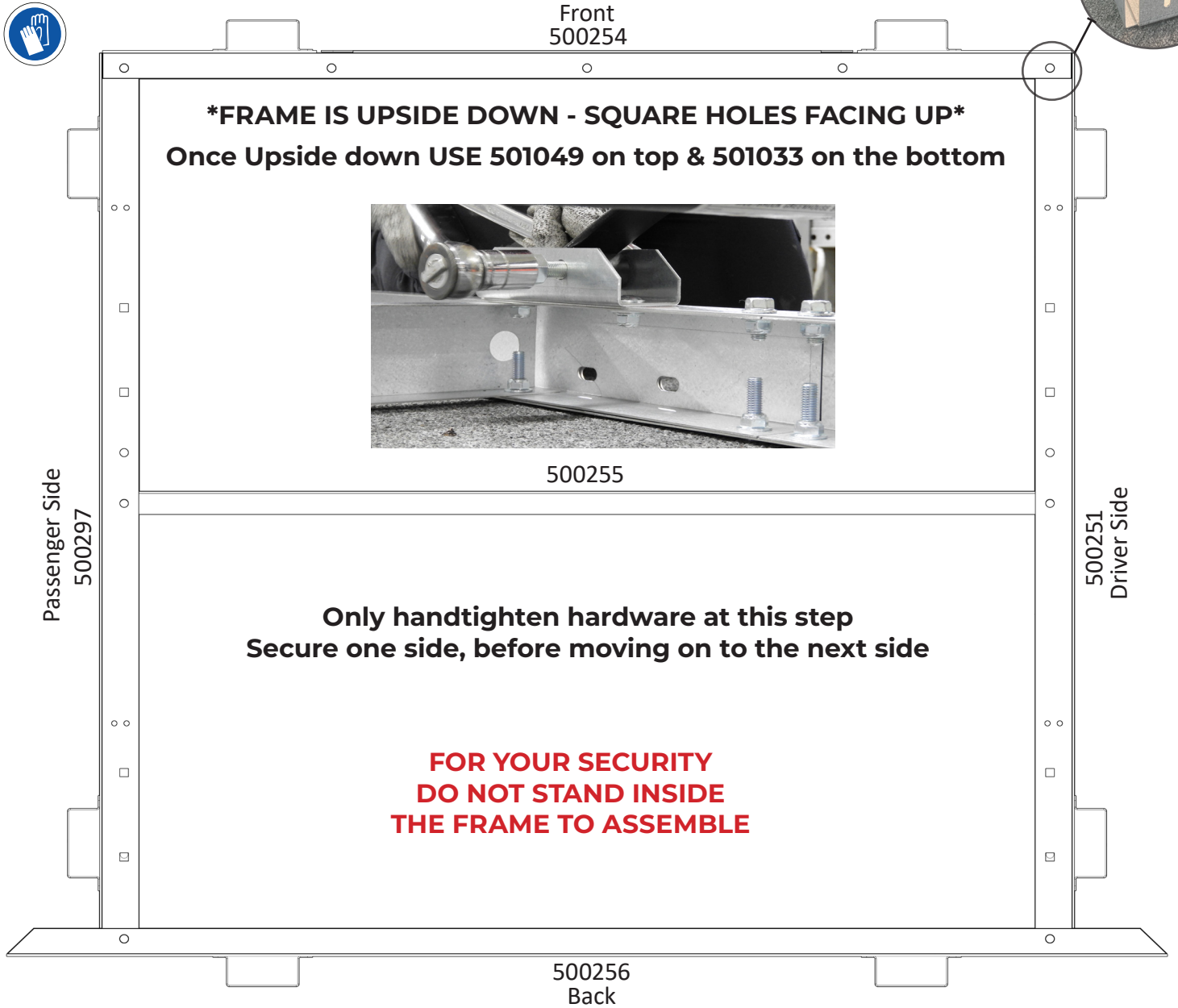

Step 3b- Frame Assembly - 4'x 6' Kit Trailer Frame

ITEM #	PARTS DESCRIPTION	QTY
501049	3/8 X 3/4 HEX FLANGE BOLT	4
501033	3/8 X 1 1/2 HEX BOLT (FULL THREAD)	8
501031	3/8 FLANGE LOCK NUT	12
500254	FRONT CHANNEL	1
500255	CROSS CHANNEL	1
500256	REAR CHANNEL	1
500252	6' DRIVER SIDE CHANNEL	1
500298	6' PASSENGER SIDE CHANNEL	1
501171	ELECTRICAL WIRE GROMMET	4

IMPORTANT INFORMATION

- To avoid having to flip the trailer twice throughout the assembly, start with the frame **UPSIDE DOWN**.
- We recommend that you complete one side before moving on to the other
- **The longer hex bolts will be used to secure the plywood floor with frame.**
- **Assemble the frame but only hand-tighten the hardware, they will be tightened in a later step.**

ASSEMBLY INSTRUCTION

1. Gather the frame pieces and the hardware placing them in their respective position as shown in **Figure 1**.
2. When placing your frame piece, **match the hole configuration** shown in Figure 1. For example, the passenger side channel **the square holes should be facing up**.
3. Both passenger and driver side channel overlaps with the front channel; **do not insert one channel inside the other.** (see Figure #1).
4. **Loosely** connect the all channels using the $\frac{3}{8} \times \frac{3}{4}$ hex flange bolt and $\frac{3}{8}$ lock nut on the top, and the $\frac{3}{8} \times 1 \frac{1}{2}$ hex bolt and $\frac{3}{8}$ lock nut at the bottom. The $\frac{3}{8} \times 1 \frac{1}{2}$ bolts will be used to secure the plywood floor with frame. (Refer picture shows on side page)
5. Take a cross-channel and **loosely** connect both to the frame using the $\frac{3}{8} \times 1 \frac{1}{2}$ hex bolt and $\frac{3}{8}$ lock nut **at the bottom only**. The top will be secured when you install the axle.
6. Repeat for other side.
7. Slide the rear channel over the passenger and driver's side channel and **loosely** connect using the $\frac{3}{8} \times \frac{3}{4}$ flange bolts and $\frac{3}{8}$ lock nuts on top, and the $\frac{3}{8} \times 1 \frac{1}{2}$ hex bolts and $\frac{3}{8}$ lock nuts at the bottom.

4'x 6' Kit Trailer Frame

 **The edges of the trailer can be very sharp.
To prevent injury, wear the provided safety gloves.**

Figure 1.

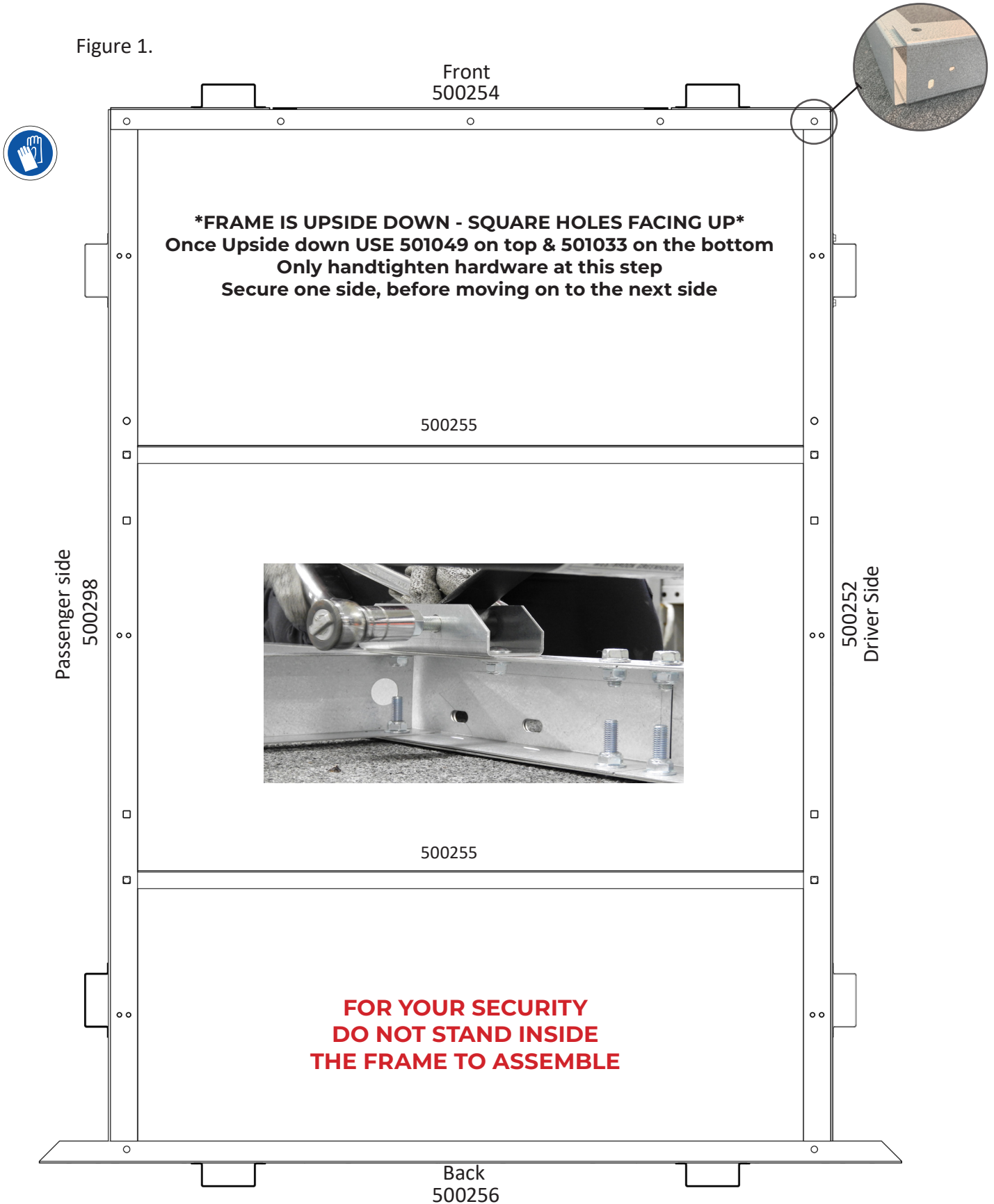

Step 3c- Frame Assembly - 4'x 8' Kit Trailer Frame

ITEM #	PARTS DESCRIPTION	QTY
501049	3/8 X 3/4" HEX FLANGE BOLT	12
501033	3/8 X 1 1/2" HEX BOLT (FULL THREAD)	8
501031	3/8 NYLON INSERT HEX FLANGE Lock nut	20
500254	FRONT CHANNEL	1
500255	CROSS CHANNEL	4
500256	REAR CHANNEL	1
500253	4' FRONT DRIVER SIDE CHANNEL	1
500299	4' REAR DRIVER SIDE CHANNEL	1
500300	4' FRONT PASSENGER SIDE CHANNEL	1
500301	4' REAR PASSENGER SIDE CHANNEL	1
500272	CONNECTION CHANNEL	2
501171	ELECTRICAL WIRE GROMMET	8

IMPORTANT INFORMATION

- To avoid having to flip the trailer twice throughout the assembly, start with the frame **UPSIDE DOWN**.
- We recommend that you complete one side before moving on to the other.
- **The longer hex bolts will be used to secure the plywood floor with frame.**
- **Assemble the frame but only hand-tighten the hardware, they will be tightened in a later step.**

ASSEMBLY INSTRUCTION

1. Gather the frame pieces and the hardware placing them in their respective position as shown in **Figure 1**.
2. When placing your frame piece, **match the hole configuration** shown in Figure 1. For example, the passenger side channel **the square holes should be facing up**.
3. Both passenger and driver side channel overlaps with the front channel; **do not insert one channel inside the other.** (see Figure #1).
4. **Loosely** connect the first side channel using the $\frac{3}{8}$ x $\frac{3}{4}$ hex flange bolt and $\frac{3}{8}$ lock nut on the top, and the $\frac{3}{8}$ x 1 $\frac{1}{2}$ hex bolt and $\frac{3}{8}$ lock nut at the bottom. The $\frac{3}{8}$ X 1 $\frac{1}{2}$ bolts will be used to secure the plywood floor with frame. (Refer picture shows on side page)
5. Take the first cross-channel and **loosely** connect it to the frame using the $\frac{3}{8}$ x $\frac{3}{4}$ flange bolt and $\frac{3}{8}$ lock nut on top and the $\frac{3}{8}$ x 1 $\frac{1}{2}$ hex bolt and $\frac{3}{8}$ lock nut at the bottom.
4. Slide the connection channel over top of the front and back side channels. Then add the second cross-channel to the first hole of the connection channel and fasten all three channels at the **bottom only** using the $\frac{3}{8}$ x 1 $\frac{1}{2}$ hex bolt $\frac{3}{8}$ lock nut. The top will be secured when you install the axle.
6. Loosely connect the center of the connection channel using the $\frac{3}{8}$ x $\frac{3}{4}$ flange bolts and $\frac{3}{8}$ lock nut on top, and the $\frac{3}{8}$ x 1- $\frac{1}{2}$ hex bolt and $\frac{3}{8}$ lock nut at the bottom.
7. Connect the third cross-channel to the last hole of the connection channel and fasten all three channel at the bottom using the $\frac{3}{8}$ x 1 $\frac{1}{2}$ hex bolt $\frac{3}{8}$ lock nut. The top will be secured when you install the axle.
8. Repeat step 2 for the fourth cross-channel
9. Repeat steps 1 – 6 for the other side. Repeat for other side.
10. Slide the rear channel over the passenger and driver's side channel and **loosely** connect using the $\frac{3}{8}$ x $\frac{3}{4}$ flange bolts and $\frac{3}{8}$ lock nuts on top, and the $\frac{3}{8}$ x 1 $\frac{1}{2}$ hex bolts and $\frac{3}{8}$ lock nuts at the bottom.

4'x 8' Kit Trailer Frame

 **The edges of the trailer can be sharp.
To prevent injury, wear the provided safety gloves.**

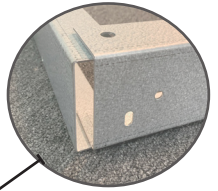
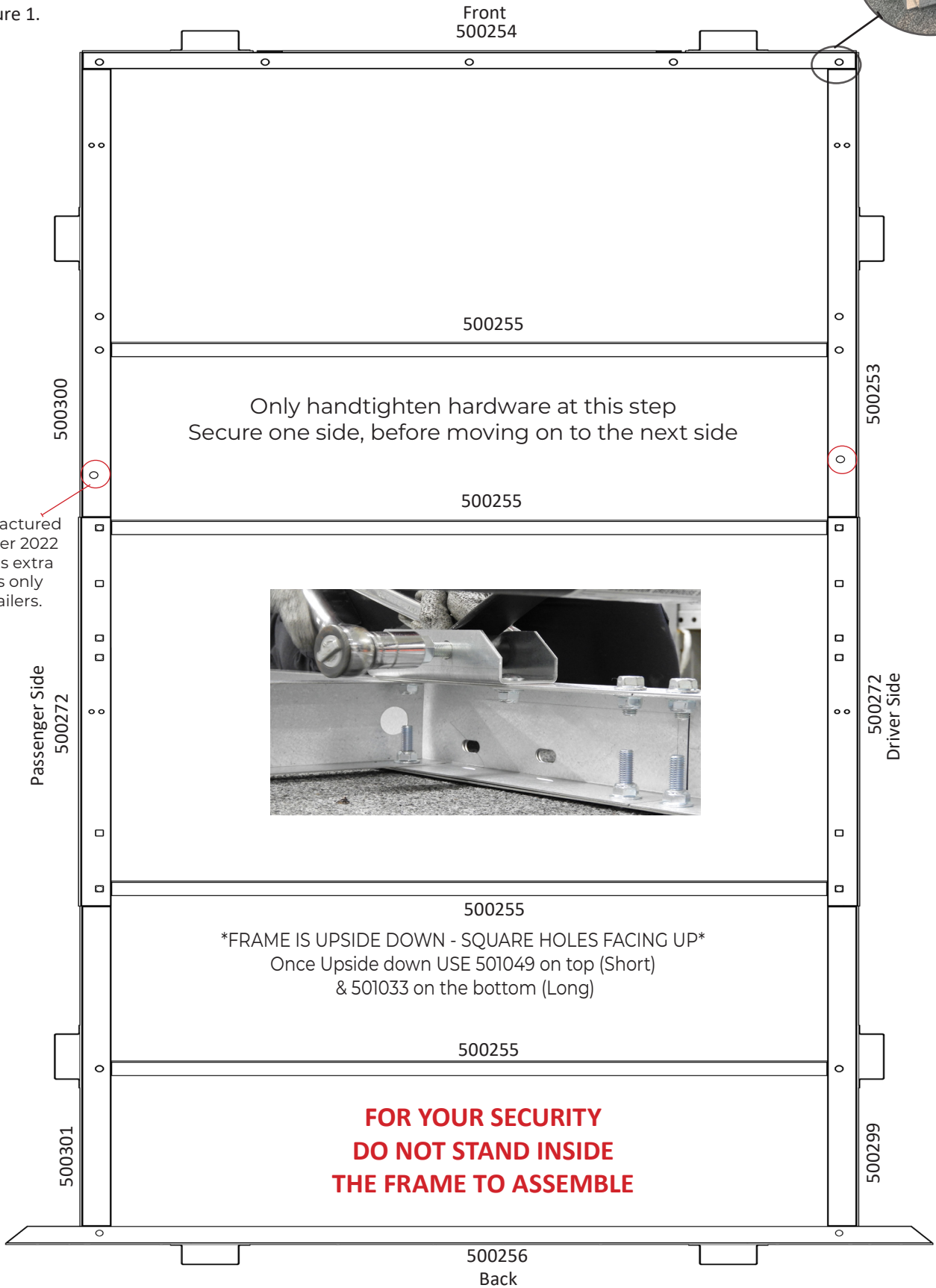
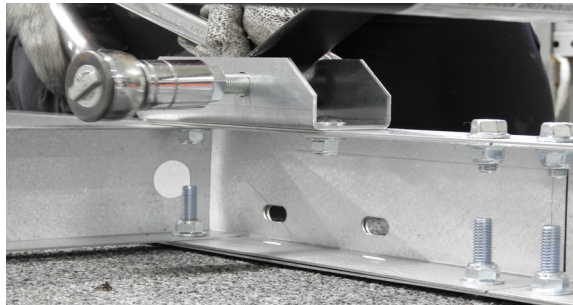

Figure 1.



Channel manufactured before November 2022 will not have this extra hole. This hole is only used for 5'x8' trailers.



Step 3d- Frame Assembly - 5' x 8' Kit Trailer Frame

ITEM #	PARTS DESCRIPTION	QTY
501049	3/8 X 3/4" HEX FLANGE BOLT	14
501033	3/8 X 1 1/2" HEX BOLT (FULL THREAD)	14
501031	3/8 NYLON INSERT HEX FLANGE Lock nut	28
504599	FRONT CHANNEL	1
504602	CROSS CHANNEL	5
504600	REAR CHANNEL	1
500253	4' FRONT DRIVER SIDE CHANNEL	1
500299	4' REAR DRIVER SIDE CHANNEL	1
500300	4' FRONT PASSENGER SIDE CHANNEL	1
500301	4' REAR PASSENGER SIDE CHANNEL	1
500272	CONNECTION CHANNEL	2
501171	ELECTRICAL WIRE GROMMET	10

IMPORTANT INFORMATION

- To avoid having to flip the trailer twice throughout the assembly, start with the frame **UPSIDE DOWN**. We recommend that you complete one side before moving on to the other.
- **The longer hex bolts will be used to secure the plywood floor with frame.**
- **Assemble the frame but only hand-tighten the hardware, they will be tightened in a later step.**

ASSEMBLY INSTRUCTION

1. Gather the frame pieces and the hardware placing them in their respective position as shown in **Figure 1**.
2. When placing your frame piece, **match the hole configuration** shown in Figure 1. For example, the passenger side channel **the square holes should be facing up**.
3. Both passenger and driver side channel overlaps with the front channel; **do not insert one channel inside the other.** (see Figure #1).
4. **Loosely** connect the first side channel using the $\frac{3}{8}$ X $\frac{3}{4}$ hex flange bolt and $\frac{3}{8}$ lock nut on the top, and the $\frac{3}{8}$ x 1 $\frac{1}{2}$ hex bolt and $\frac{3}{8}$ lock nut at the bottom. The $\frac{3}{8}$ X 1 $\frac{1}{2}$ bolts will be used to secure the plywood floor with frame. (Refer picture shows on side page)
5. Slide the connection channel over top of the front and back side channels.
6. Take the first cross-channel. Position the first cross-channel **opening toward the front channel**. Loosely secure all three channels at the **bottom only** with the $\frac{3}{8}$ x 1- $\frac{1}{2}$ hex bolt $\frac{3}{8}$ lock nut. When you put the axle in place, the top will be held in place.
7. Position the second cross-channel **opening toward the front channel** and the third one facing the opposite way. (figure 1). Loosely connect both cross-channels to all three channels and loosely fasten at the bottom using the $\frac{3}{8}$ x 1- $\frac{1}{2}$ hex bolt & $\frac{3}{8}$ lock nut and at the top with $\frac{3}{8}$ x $\frac{3}{4}$ hex flange bolt and $\frac{3}{8}$ lock nut.
8. Connect the fourth cross-channel to the last hole of the connection channel and fasten all three channel at the bottom using the $\frac{3}{8}$ x 1- $\frac{1}{2}$ hex bolt $\frac{3}{8}$ lock nut. The top will be secured when you install the axle.
9. The $\frac{3}{8}$ x $\frac{3}{4}$ flange bolts and $\frac{3}{8}$ lock nut on top and the $\frac{3}{8}$ x 1- $\frac{1}{2}$ hex bolt and $\frac{3}{8}$ lock nut (on the bottom) are used to attach the fifth connection channel.
10. Repeat steps 1 – 5 for the other side.
11. The $\frac{3}{8}$ x $\frac{3}{4}$ flange bolts and $\frac{3}{8}$ lock nuts on top and the $\frac{3}{8}$ x 1- $\frac{1}{2}$ hex bolts and $\frac{3}{8}$ lock nuts on the bottom are used to connect the rear channel to the passenger and driver's side channels.

5'x 8' Kit Trailer Frame -

 **The edges of the trailer can be sharp.
To prevent injury, wear the provided safety gloves.**

Figure 1.



STEP 4 – Axle Assembly

ITEM #	DESCRIPTION	4X4, 4X6 & 4X8	5X8
500047	4' STRAIGHT AXLE	1	
504617	5' STRAIGHT AXLE		1
500809	750 LB. SPRINGS	2	2
500814	3/8-16 U-BOLT	4	4
500259	LEAF SPRING MOUNTING BRACKET	4	4
500260	LEAF SPRING AXLE MOUNT PLATE	2	2
501031	3/8-16 NYLON INSERT HEX FLANGE LOCK NUT	16	16
501036	3/8 X 3/4" CARRIAGE BOLT	8	8
501032	3/8" FLAT WASHER	8	8
501065	9/16-18 UNF X 3" HEX BOLT	4	4
501066	9/16-18 UNF NYLON INSERT LOCKING NUT	4	4

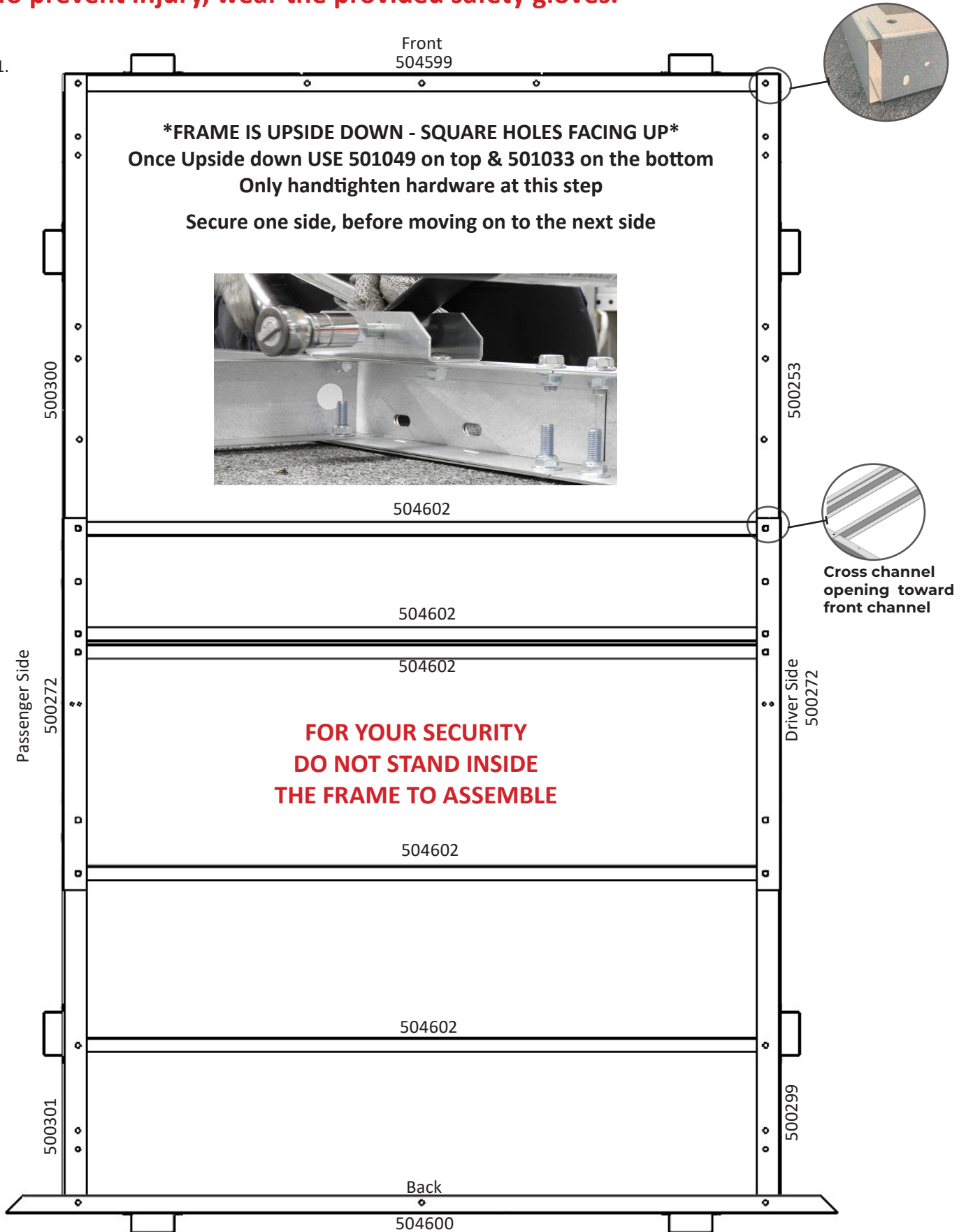
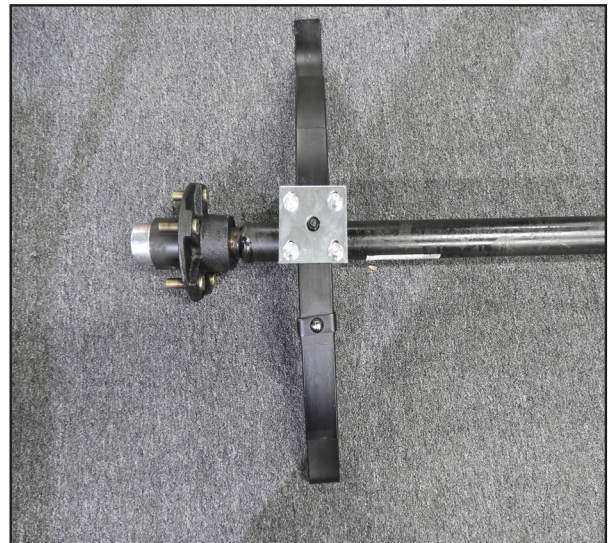
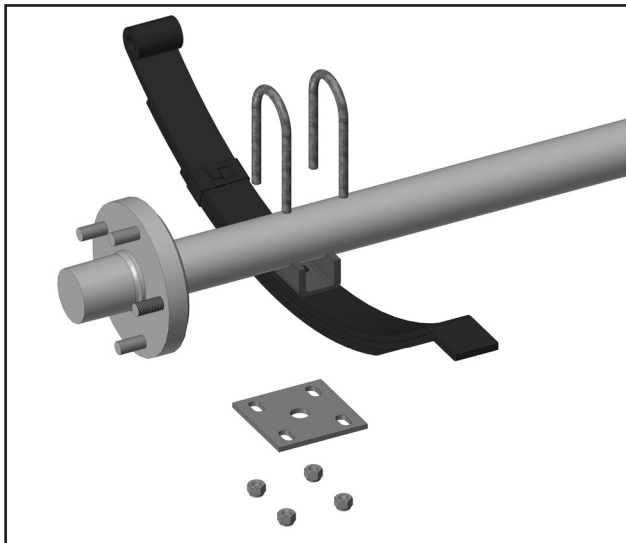
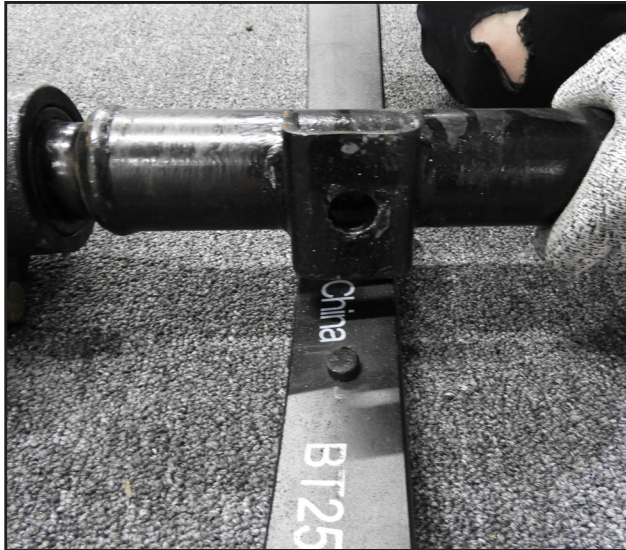

STEP 4 – Axle Assembly

1. Secure the leaf spring mounting brackets in the square holes on each side of the trailer with the carriage bolt $\frac{3}{8}$ x $\frac{3}{4}$ and $\frac{3}{8}$ lock nut using $\frac{9}{16}$ socket; the round holes of the brackets should be oriented closest to the center.
2. **Where there is no cross-channel at the fastening location of the mounting bracket use a $\frac{3}{8}$ washer as a spacer.**
3. Lay the axle between the mounting brackets.
4. Place the springs inside the mounting bracket with eye of the spring towards the front and the flat side towards the back of the trailer. Secure the spring to mounting bracket with the $\frac{9}{16}$ hex bolts and $\frac{9}{16}$ lock nuts using $\frac{7}{8}$ socket and wrench.
5. Do not **over-tighten as there needs to be movement** in the spring. Do this for both sides.
6. Place the first U-bolt around the axle. Line up the leaf spring mount plate with the oval holes running in the same direction as your leaf spring. Hand-tighten with the $\frac{3}{8}$ locking nut. Repeat for all other U-bolts.
7. Secure all the U-bolts with a $\frac{9}{16}$ socket.
8. **Using two people, flip the frame.**



CAUTION! FLIPPING THE TRAILER OVER REQUIRES TWO PEOPLE



Where there is no cross-channel at the fastening location of the mounting bracket use a $\frac{3}{8}$ washer as a spacer.

The hole in the mounting should be facing each other.

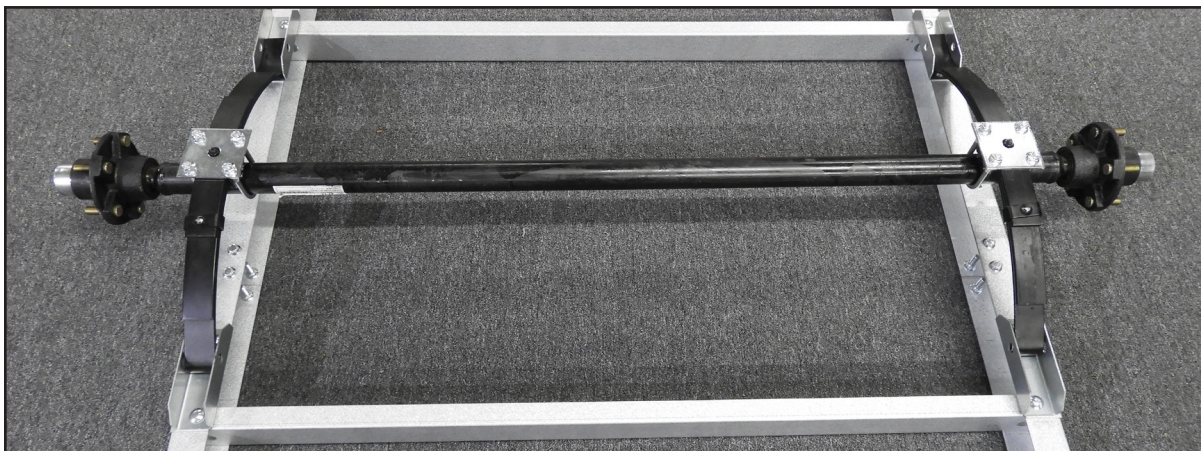

Step 5- Fender & Wheels

ITEM #	DESCRIPTION	QTY
501091	#10 X 1/2" PHILLIPS #2 MACHINE SCREW	8
501092	#10 LOCKING NUT	8
501049	3/8 X 3/4" HEX FLANGE BOLT	6
501031	3/8 NYLON INSERT LOCKING NUT	6
501001	1/2" WHEEL NUTS	10
48-048-KO8, 48-072-KO8, 48-096-KO8 (8" Wheel)		
500258	8" FENDER	2
500841	4.80 X 8 LRC TIRE & WHEEL	2
504447	FENDER PLATE - 8"	2
48-072-KO12, 48-096-KO12, 60-096-KO12 (12" Wheel)		
504212	12" FENDER	2
500844	4.80 X 12 LRC TIRE & WHEEL	2
504476	FENDER PLATE - 12"	2

1. Align the fender support plate with the frame and secure with the #10 machine screws and #10 lock nuts using a $\frac{3}{8}$ socket and Phillips screwdriver. If the holes are not perfectly aligned use a punch to align them.
2. Place the fender over top of the fender plate, hand-tighten the top hole using the $\frac{3}{8}$ x $\frac{3}{4}$ Hex flange bolt and $\frac{3}{8}$ lock nut, making sure the nut is inside of the fender.
3. Place the tire on the hub and secure it to the rim with $\frac{1}{2}$ wheel nuts using $\frac{13}{16}$ socket and torque to 95ft-lbs.
4. Hand tighten the other two holes to the frame using the $\frac{3}{8}$ x $\frac{3}{4}$ Hex flange bolts and $\frac{3}{8}$ lock nuts.
5. Tighten all the fender bolts using a $\frac{9}{16}$ socket and wrench.
6. Repeat for other side.
- 7. Make sure wheel nuts are installed in same position as shown in picture.**

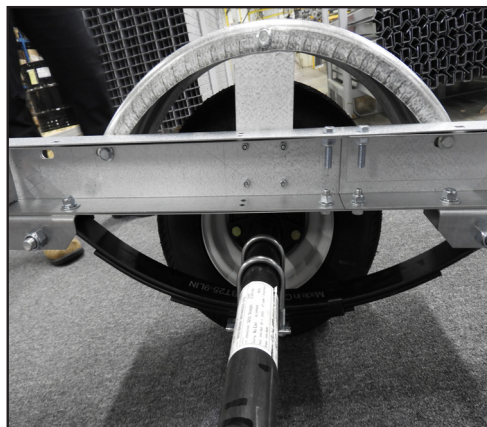

Step 6 - Tongue Assembly

ITEM #	DESCRIPTION	4 FT	5 FT
500257	TONGUE CHANNEL FOR 4 FT TRAILER	2	
504601	TONGUE CHANNEL FOR 5 FT TRAILER		2
504623	TONGUE CROSS CHANNEL		1
504162	5' - TONGUE CONNECTION BRACKET	1	1
501049	3/8 X 3/4" HEX FLANGE BOLT	8	10
501033	3/8 X 1 1/2" HEX BOLT (FULL THREAD)	4	6
501031	3/8 NYLON INSERT HEX FLANGE LOCK NUT	4	6
501100	5/16 UNC X 1/2" CUTTING SCREW	4	4
500512	4 WAY FLAT 20' WIRE HARNESS	1	1
501171	ELECTRICAL WIRE GROMMET	4	4

1. Take the two tongue channels and slide them through the vertical slots of the front channel and Take tongue channels and install the electrical grommet. Do this for both channels.
2. Hand tighten to the frame in two places using the $\frac{3}{8}$ x $1\frac{1}{2}$ hex bolts and $\frac{3}{8}$ lock nuts on top and the flange bolts $\frac{3}{8}$ x $\frac{3}{4}$ and $\frac{3}{8}$ lock nuts at the bottom.
- 3. If the tongue is not aligning with the frame's holes, make sure all bolts are loose.**

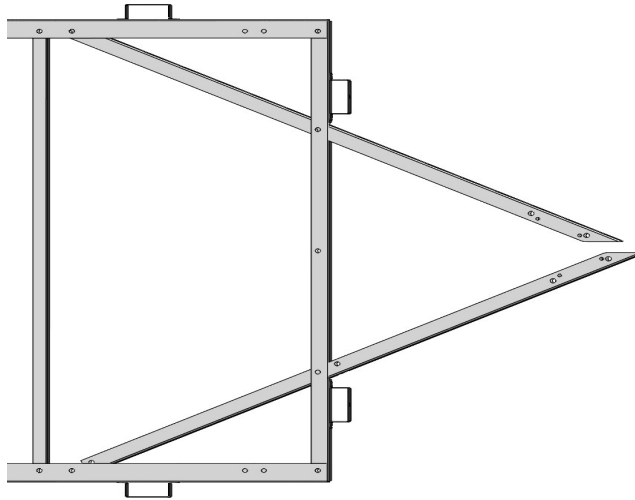

2a. FOR 5X8 TONGUE ASSEMBLY ONLY

Put **tongue cross channel** in between tongue channel and fasten it with the $\frac{3}{8}$ x $1\frac{1}{2}$ hex bolts and $\frac{3}{8}$ lock nuts on top and the flange bolts $\frac{3}{8}$ x $\frac{3}{4}$ and $\frac{3}{8}$ lock nuts at the bottom.

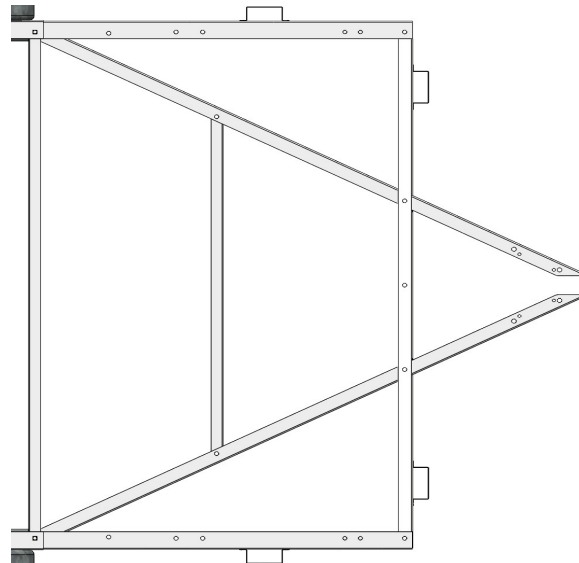

Step 7 - Tongue Connection Support Installation

1. Put the tongue connection bracket with the threaded holes facing up place without sliding it fully into position.
2. Feed each wire of the wire harness between the tongue channel and separate your wire as follows.
 - Yellow and brown wire on the driver's side
 - Green and brown wire on the passenger's side
 - Do not pull the white wire through, you will secure it to the coupler channel once it's assembled.
3. Slide the tongue connection bracket in place and hand tighten using the $\frac{3}{8} \times \frac{3}{4}$ flange bolts on top.
4. On the bottom, in the four pre-drilled holes, secure with the cutting screws using a $\frac{1}{2}$ socket.
5. Secure the top bolts using $\frac{9}{16}$ socket.
- 6. Tighten all the bolts of the trailer frame using a $\frac{9}{16}$ socket and wrench. If you are going to add a plywood sheet before using the trailer, you don't need to tighten the top bolts until the plywood has been added.**

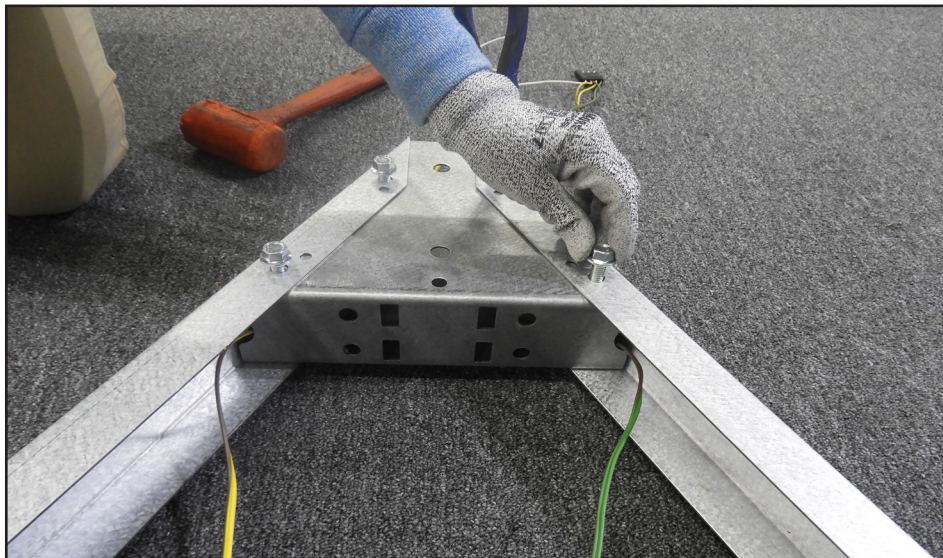
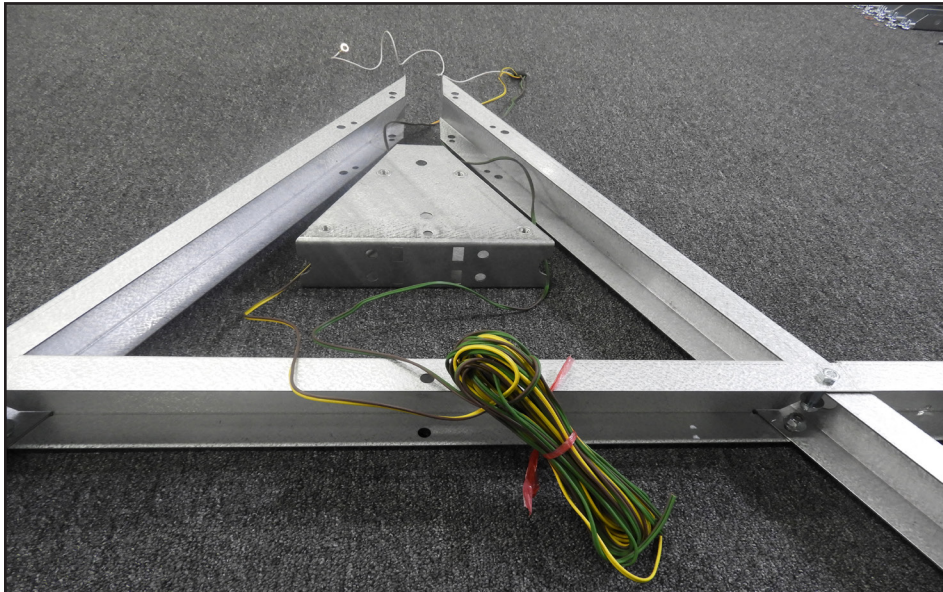

Step 8 – Hitch and Safety Chains

ITEM #	DESCRIPTION	QTY
504163	LONG COUPLER CHANNEL	1
504198	TONGUE SUPPORT FOOT - CHANNEL TONGUE	1
500805	1 7/8" COUPLER CLASS I	1
500804	SAFETY CHAIN - 3/16 X 4' (CLASS I)	1
501031	3/8 NYLON INSERT LOCKING NUT	3
501023	3/8 X 2-1/2" HEX BOLT	1
501024	3/8 X 3" HEX BOLT	2
501060	1/2 X 3 1/2" HEX BOLT	2
501056	1/2 NYLON INSERT LOCKING NUT	2

Assemble the coupler upside down.

1. Place the long coupler channel with the opening facing up.
2. Take the safety chain by the two hooks and find the center link. Place the bolt through the third hole of the channel and center link, and hand-tighten using the 2-1/2 hex bolt and 3/8 lock nut.
3. Insert the tongue support foot into the coupler channel as far as it will go.
4. Put the coupler on the channel and secure with 3/8 x 3 hex bolts and 3/8 lock nuts using a 9/16 socket and wrench, making sure it's tight enough that the tongue foot doesn't move but the coupler spring releases.
5. Pull the excess wire through the connection bracket leaving enough wire at the front to connect the white wire to the coupler.
6. Slide the assembled coupler channel into the tongue connection being careful not to pinch the wiring.
7. Line up the holes with the holes of tongue connection bracket and secure with 1/2 x 3 1/2 hex bolts & 1/2 lock nuts tighten using 3/4 socket and wrench.
8. Remove the 3/8 lock nut (from the chain bolt and place ring terminal of the ground white wire) on the bolt and secure holding the 9/16 wrench on the nut and 9/16 socket on the bolt head. Do not over tighten as you may damage the ring terminal.

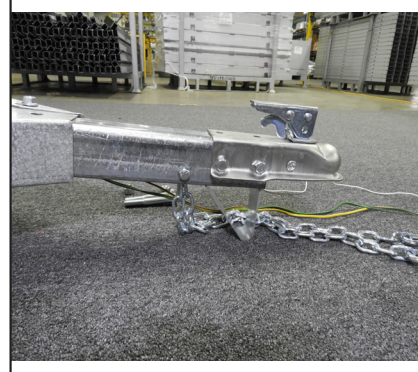
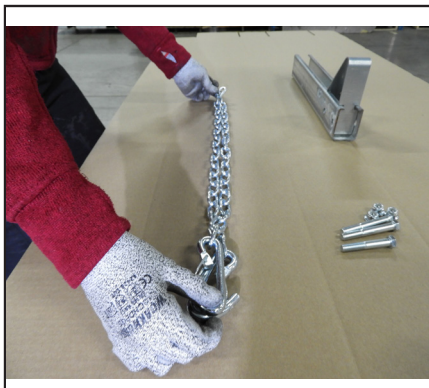

STEP 9 – Wiring & Lights

ITEM #	DESCRIPTION	4' x 4'	4'x6' & 4'x8' & 5'x8'
500512	4 WAY FLAT 20' WIRE HARNESS	1	1
503079	8" CABLE TIE	4	6
500558	WIRE CONNECTOR	2	2
500513	TAILLIGHT LEFT/DRIVER SIDE	1	1
500514	TAILLIGHT RIGHT/PASSENGER SIDE	1	1
500515	AMBER MARKER LIGHT	2	2
500516	PLASTIC LICENSE BRACKET	1	1

1. Feed the wire harness using the pre-cut holes all the way to the back and tuck some of the wire in the front corner for the marker light.
2. Place the amber marker light in the pre-drilled holes and secure it to the frame.
3. With a knife carefully separate the brown and coloured wire near the front corner and marker light.
4. Push the brown wire from the wire harness completely to the back of the wire connector.
5. Slide the marker light wire into the blue connector without exposing any wire.
6. Squeeze the metal blade of the connector down with pliers tight enough to make a connection between both wires. Verify that the blade is all the way in place and close the cover.
7. At the back of the trailer, cut the wire leaving 6", then strip ¼" and twist the copper wire. Do this for both sides.
8. Plug each wire to the corresponding hole in the back of each taillight, and secure them to the frame.
9. Secure the license plate holder on the driver's side with the taillight.
10. Pull the excess wire back into the frame and secure it with the zip ties using the holes.
11. Always test the lights before using the trailer.

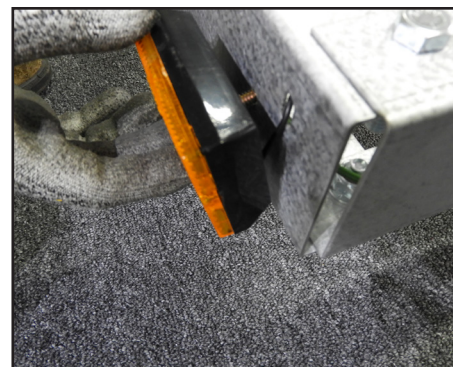
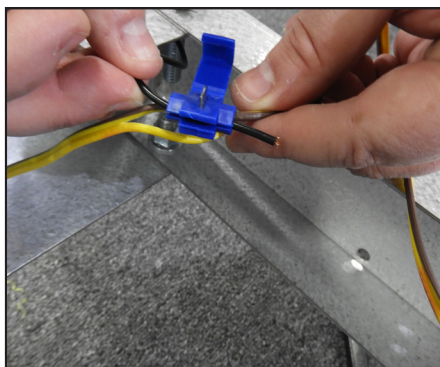
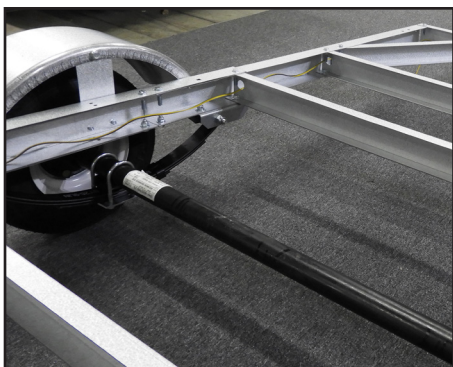

Wiring Diagram

- Ground = White Wire
- Tail/Running Lights/Marker Lights = Brown
- Left Turn/Brake = Yellow
- Right Turn/Brake = Green

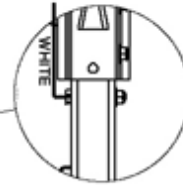
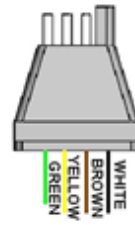

Ground white wire grommet to frame

Amber Marker Light



Amber Marker Light

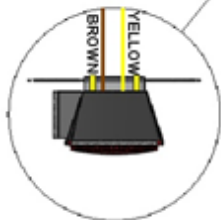

Driver's Taillight & Red Marker Light & License Light

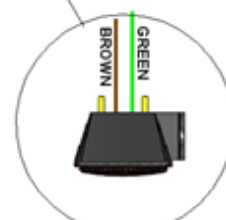

Passenger's Taillight & Red Marker Light

Completed View

4' x 4'

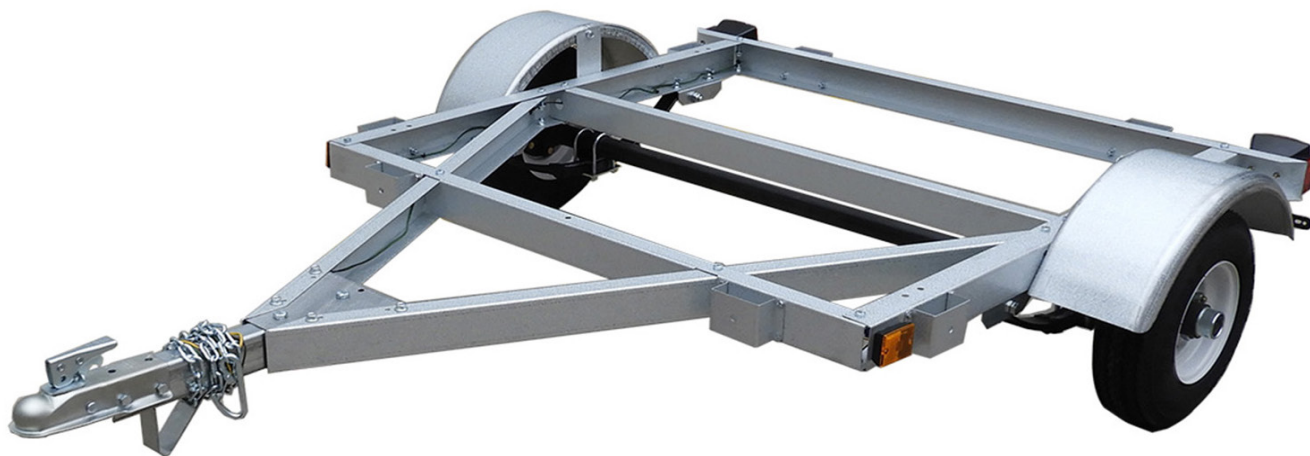

4' x 6'



Completed View



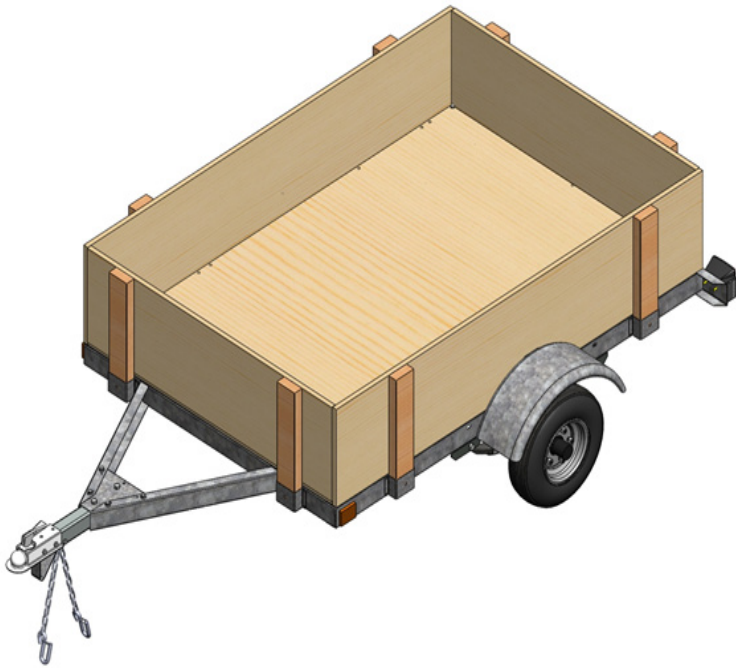

Cut List - Plywood

(Wood not included)

4' x 4'

- a. 8pcs - 2x4 -18" (12ft -2x4 makes 8pcs)
- b. 4pcs - 3/4 x 14-3/4" x 48"

4' x 6'

- a. 8pcs - 2x4 -18" (12ft -2x4 makes 8pcs)
- b. 2pcs - 3/4 x 14-3/4" x 72"
- c. 2pcs - 3/4 x 14-1/4" x 48"

4' x 8'

- a. 8pcs - 2x4 -18" (12ft -2x4 makes 8pcs)
- b. 2pcs - 3/4 x 14-3/4" x 96"
- c. 2pcs - 3/4 x 14-1/4" x 48"

5' x 8'

- a. 8pcs - 2x4 -18" (12ft -2x4 makes 8pcs)
- b. 2pcs - 3/4 x 14-3/4" x 96"
- c. 2pcs - 3/4 x 14-1/4" x 60"

Cut List - Wood Plank

(Wood not included)

4' x 4'

- a. 8pcs - 2x4 -18" (12ft -2x4 makes 8pcs)
- b. 8pcs - 1x6 - 48"

4' x 6'

- a. 8pcs - 2x4 - 18" (12ft -2x4 makes 8pcs)
- b. 4pcs - 1x6 - 72"
- c. 4pcs - 1x6 - 48"

4' x 8'

- a. 8pcs - 2x4 - 18" (12ft -2x4 makes 8pcs)
- b. 4pcs - 1x6 - 96"
- c. 4pcs - 1x6 - 48"

5' x 8'

- a. 8pcs - 2x4 - 18" (12ft -2x4 makes 8pcs)
- b. 4pcs - 1x6 - 96"
- c. 4pcs - 1x6 - 60"

4ft x 4ft Plywood Drill Template

(Plywood not included)

Drill $\frac{3}{8}$ " holes in plywood using the dimensions outlined below and use the $\frac{3}{8}$ " x 1- $\frac{1}{2}$ " full thread hex bolts to secure to the frame.

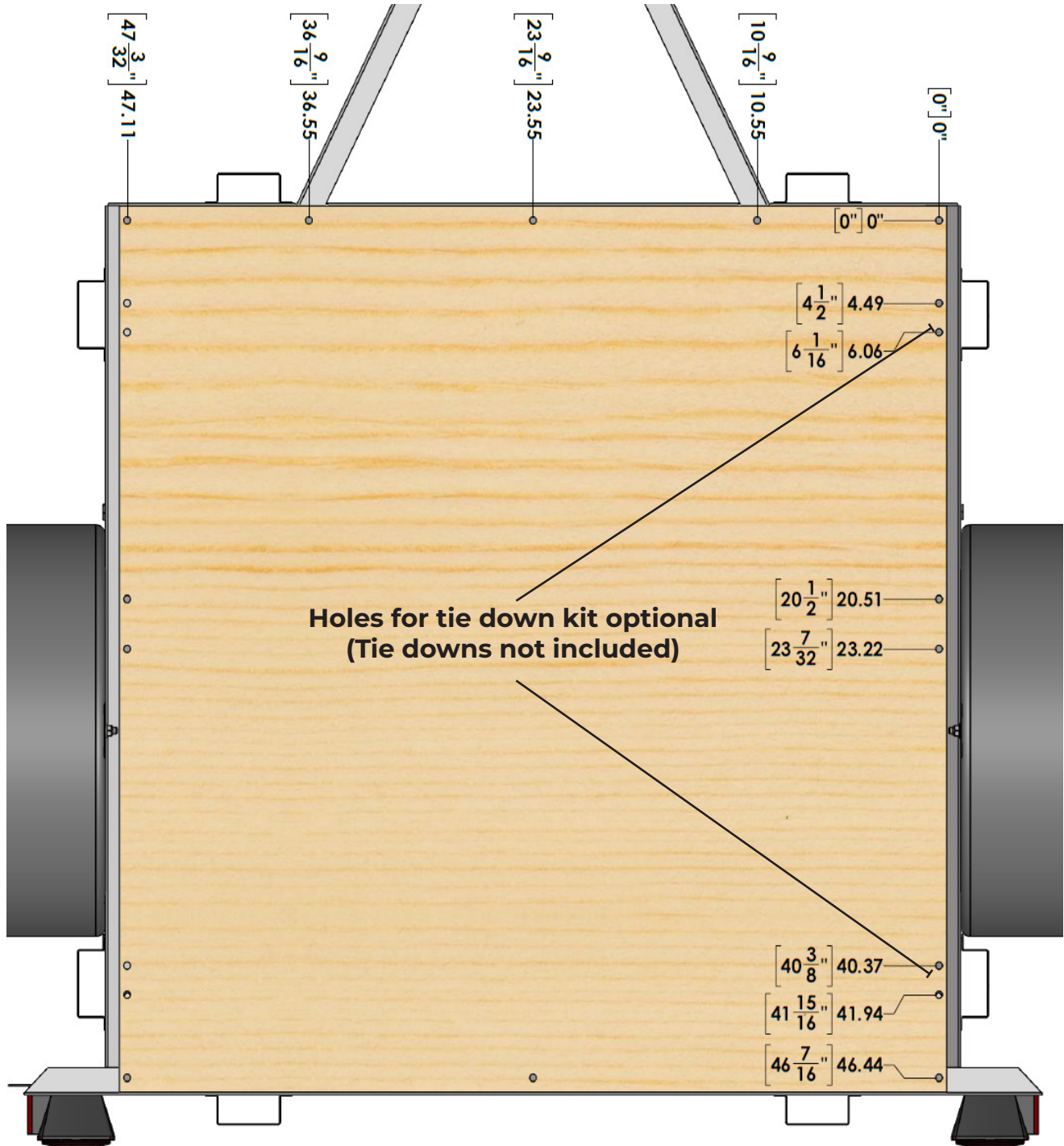

4ft x 6ft Plywood Drill Template

(Plywood not included)

Drill $\frac{3}{8}$ holes in plywood using the dimensions outlined below and use the $\frac{3}{8}$ x 1- $\frac{1}{2}$ full thread hex bolts to secure to the frame.

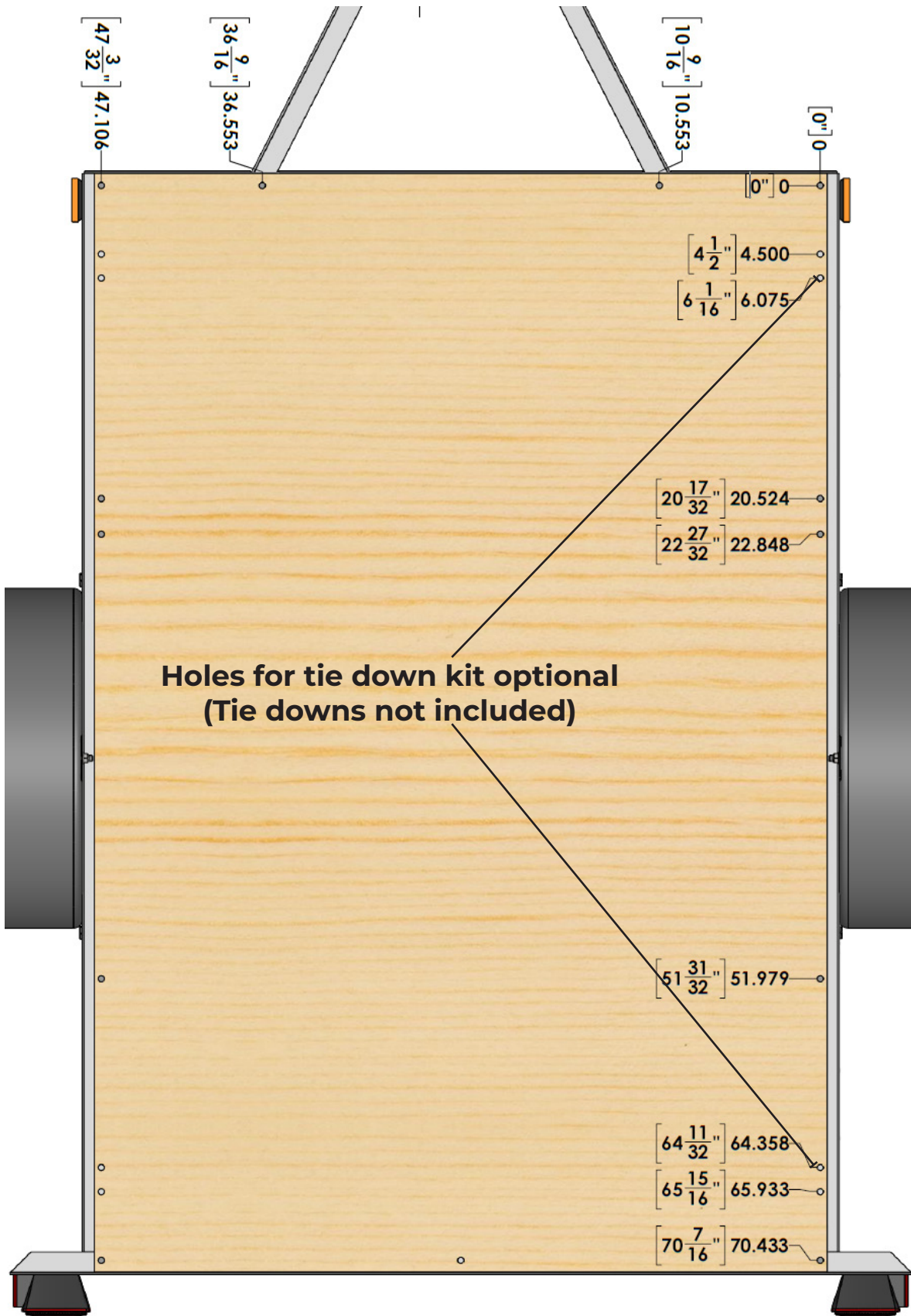

4ft x 8ft Plywood Drill Template

(Plywood not included)

Drill $\frac{3}{8}$ " holes in plywood using the dimensions outlined below and use the $\frac{3}{8}$ " x 1- $\frac{1}{2}$ " full thread hex bolts to secure to the frame.

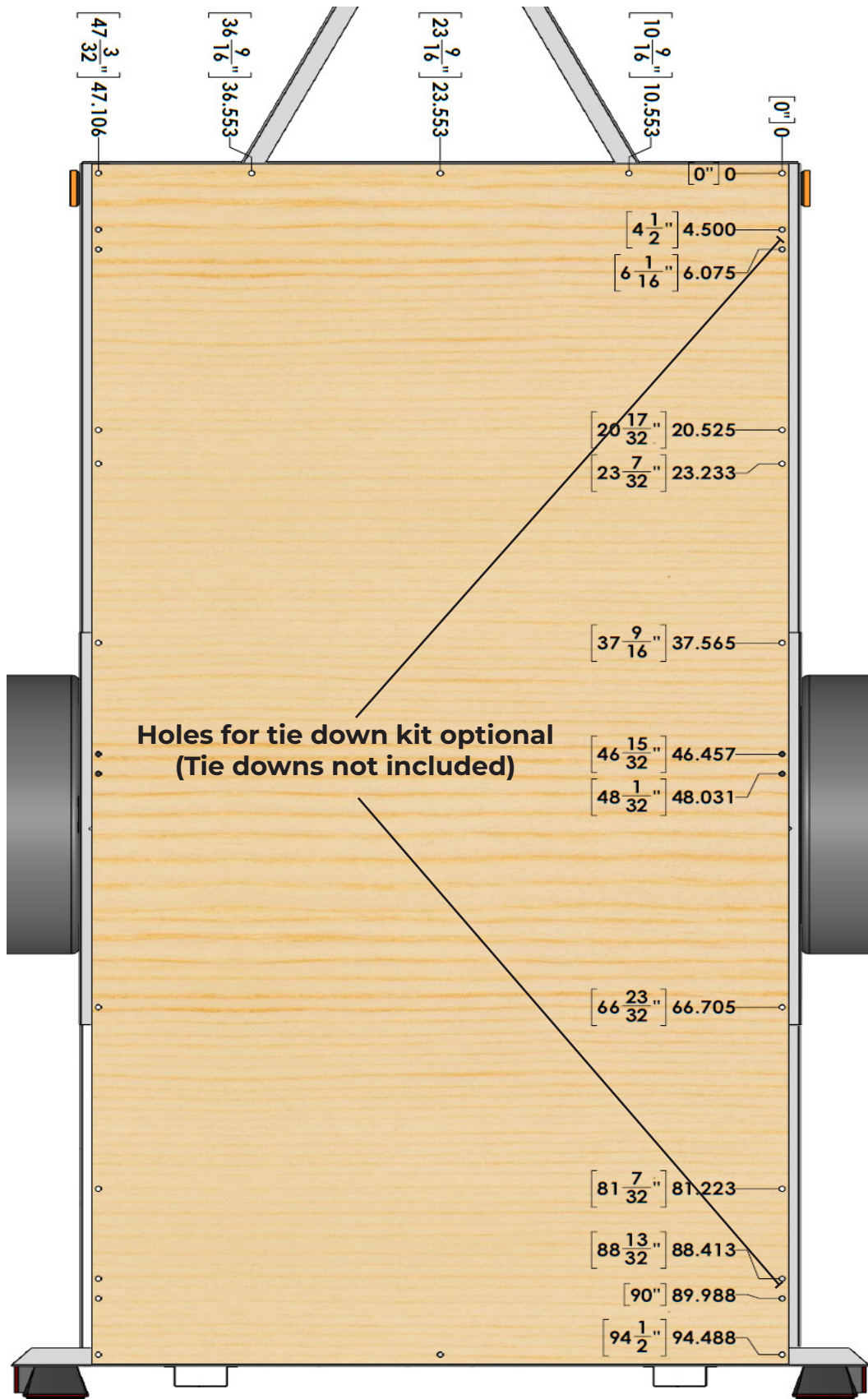

5ft x 8ft Plywood Drill Template

(Plywood not included)

Drill $\frac{3}{8}$ holes in plywood using the dimensions outlined below and use the $\frac{3}{8}$ x 1- $\frac{1}{2}$ full thread hex bolts to secure to the frame.

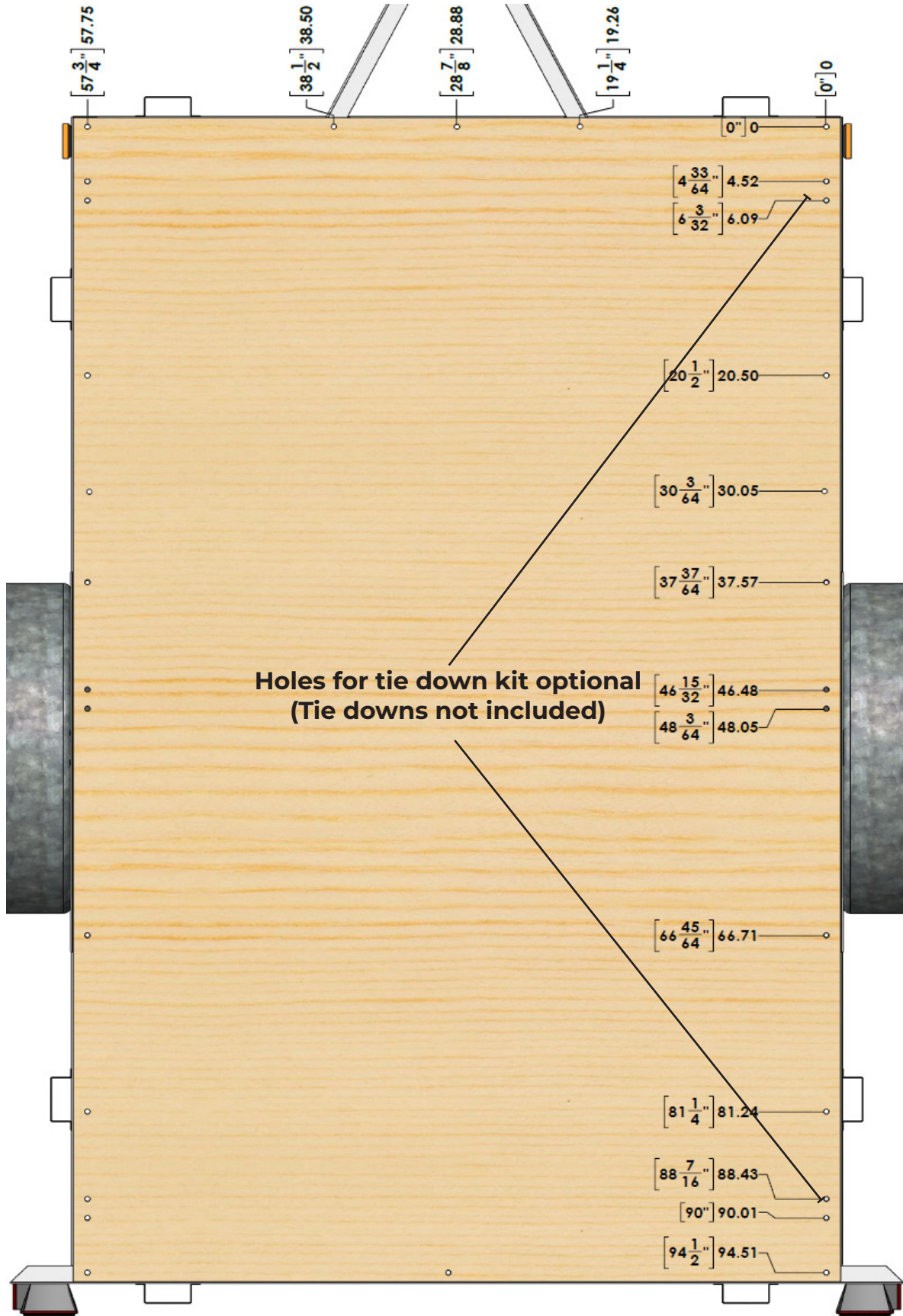



Trailer Accessories

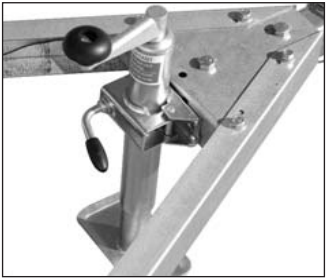

Tongue Jack

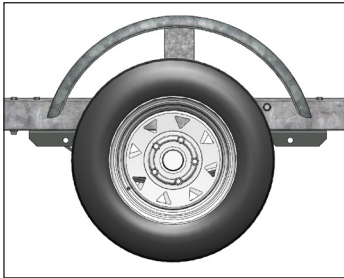

12" Wheel & Fender



Ramps

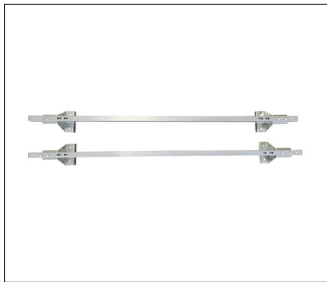

Cargo Racks

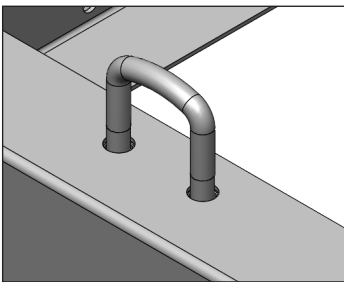

U bolt tie downs

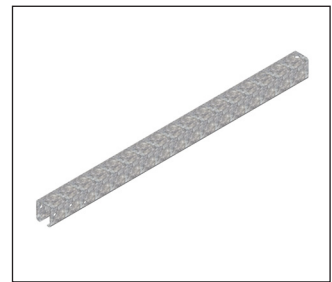

Tongue Extension



Tire bundle

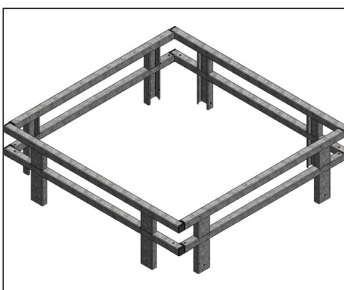

Rail Sides Kit

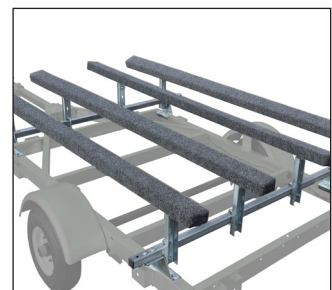

Bunks Kit

Westbrook
TRAILERS

www.westbrooktrailers.com