

PP VILLA COOP

ASSEMBLY MANUAL

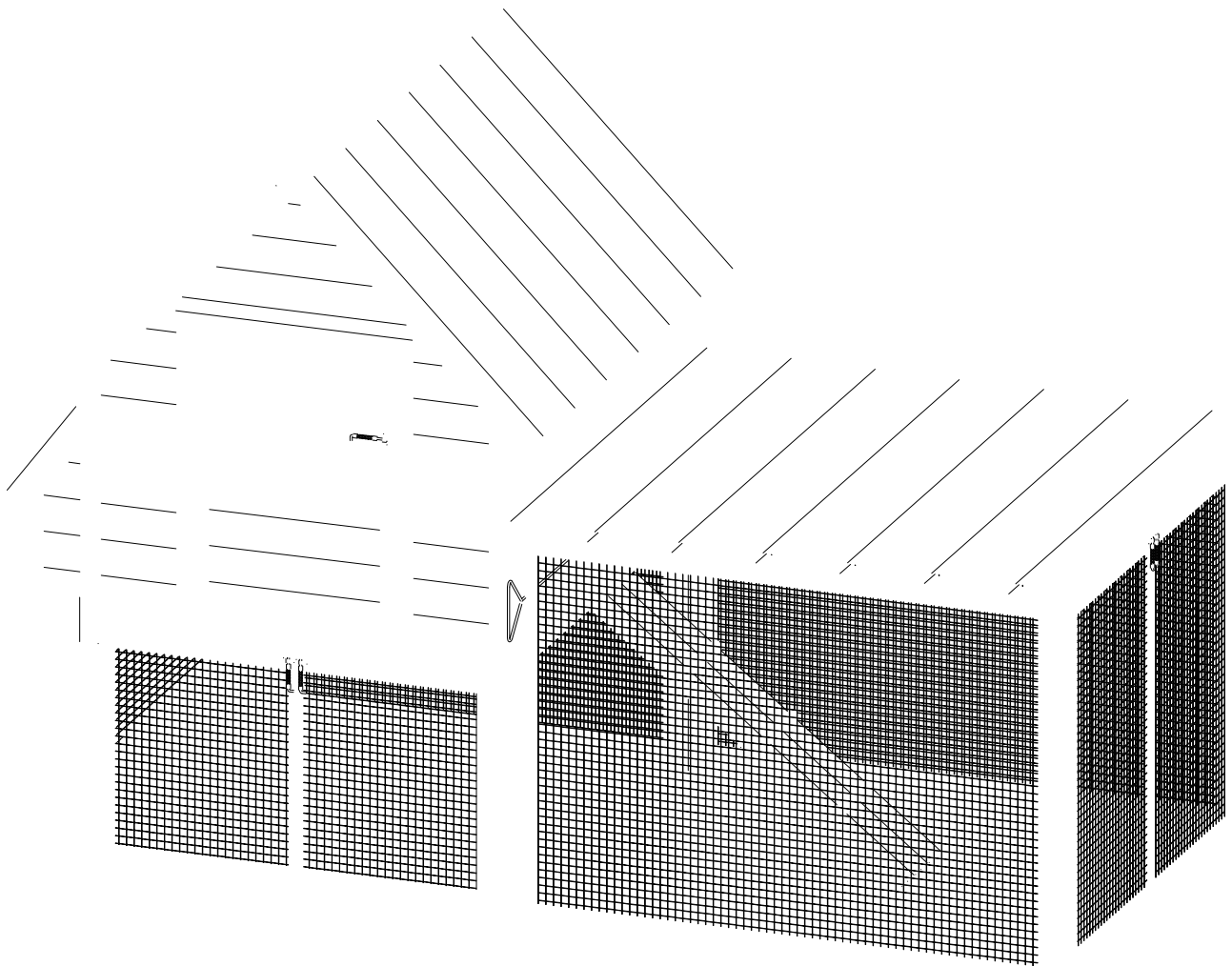

SKU# 1994542







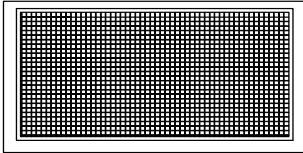
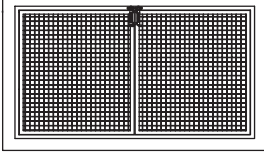
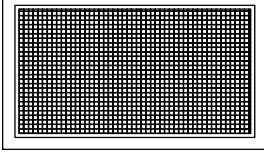
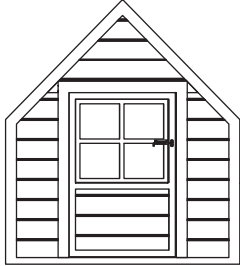
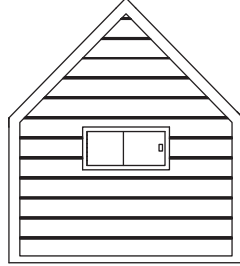
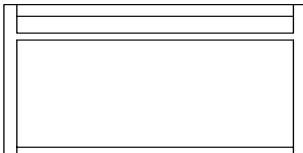

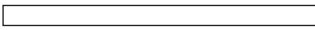
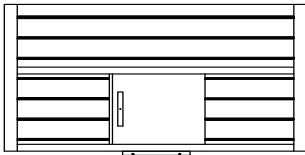
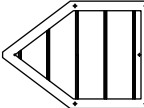



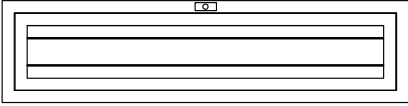

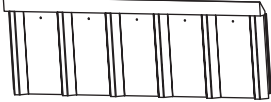

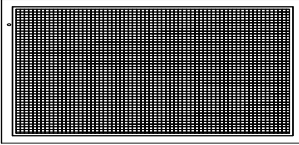
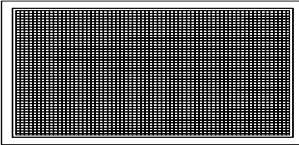
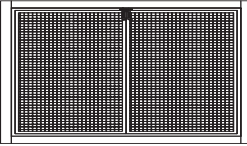
Tools required for assembly (not included)

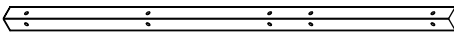

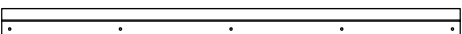

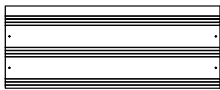

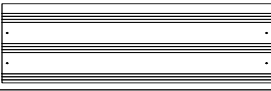





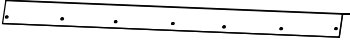

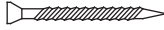

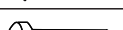

PARTS LIST

Part#	Description	Drawing	Qty.
1	Coop Bottom Run Back Panel		1
2	Coop Bottom Run Left Panel		1
3	Coop Bottom Run Right Panel		1
4	Coop Left Panel		1
5	Coop Right Panel		1
6	Coop Back Panel		1
7	Coop Floor Board		1
8	Coop PP Board		1
9	Roosting Bar		3
10	Coop Chicken Access Panel		1
11	Nesting Box Side Panel		2

PARTS LIST

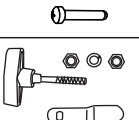
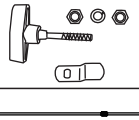
Part#	Description	Drawing	Qty.
12	Nesting Box Door Panel		1
13	Nesting Box Support Bar		1
14	Nesting Box Floor		1
15	Nesting Box Outside Roof		1
16	Nesting Box Inside Roof		1
17	Nesting Box Divider		2
18A	Run Left Panel		1
18B	Run Right Panel		1
19	Run Door Panel		1
20	Coop Connecting Bracket		2
21	Run Connecting Rail		2
22	Ramp		1
23	Coop Shoulder Support Rail		2
24	Coop Roof Peak Support		1
25	Coop Roof Board 1		2
26	Coop Roof Board 2		2
27	Run Roof Board 1		1
28	Run Roof Board 2		1
29	Rain Guard		1
30	Run Roof Support Bar		1

PARTS LIST

Part#	Description	Drawing	Qty.
31	Roof Ridge Cover		1
32	Nesting Box Rain Guard		1
33	Planter Box		2
34	Self-Tapping screw M4X60mm		29+2
35	Self-Tapping screw M4X30mm		4
36	Self-Tapping screw M4X25mm		55+3
37	Self-Tapping screw M4X20mm		34+2
38	Self-Tapping screw M2.9X13mm		5
39	Dovetail Screw M5x19mm		24+2
40	Bolt M6x25mm		8
41	Bolt M6x55mm		2
42	Nut M6		8
43	Bolt M4x20mm		1
44	T-handle Lock with Longer Tougue		1
45	T-handle Lock with Short Tougue		1
46	Access Door Handle		1
47	Roosting Bar Bracket A		4
48	Roosting Bar Bracket B		2

Get Ready

Please take out Part #4, Part #5, Part #47 & #48 first.

1. There are pre-drawn locations for #47 & #48 on the back of Coop Left Panel #4. Use Screw #36 to fix 1pc of #47, 2pcs #48 on the marked place.
2. Fix the rest 3pcs #47 on the back of Coop Right Panel #5 by bolt #40 & #42.

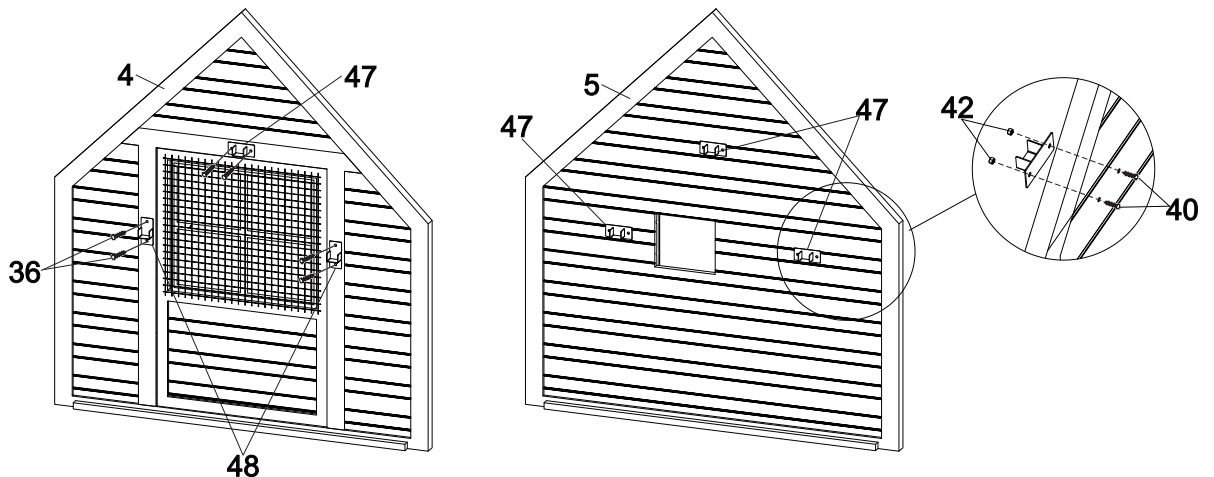

ASSEMBLY

Step 1

- Connect Part #1, #2, and #3. Use 4pcs Screws #34 through the pre-drilled holes.
- Use 6pcs of Screws #36 to fix Bracket #20 in the two top corners.

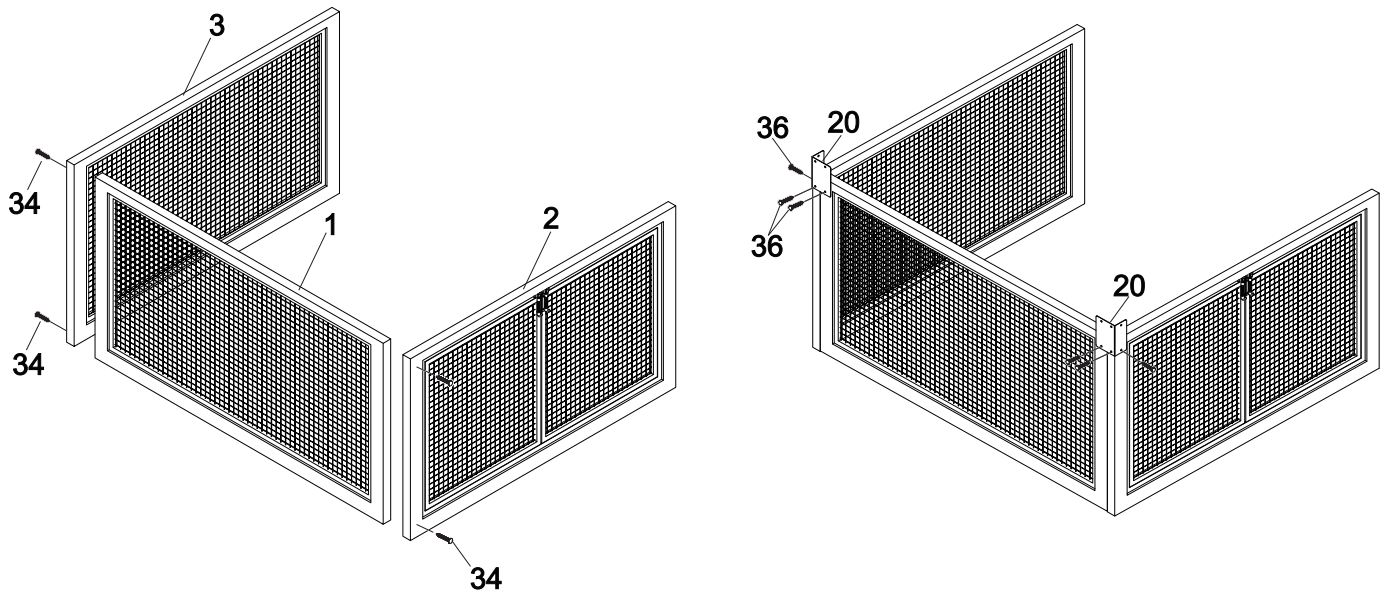

Step 2

- Assemble Coop Panel #4, #5, #6 together by 4pcs of screws #34.
- Fix the two planter boxes (#33) on the two side panels, using screws #35, 2pcs of each.
- Sit this wood structure on top of the metal structure in Step 1, connecting them by fixing the 2 corner brackets (#20), using 6pcs of Screws #36.

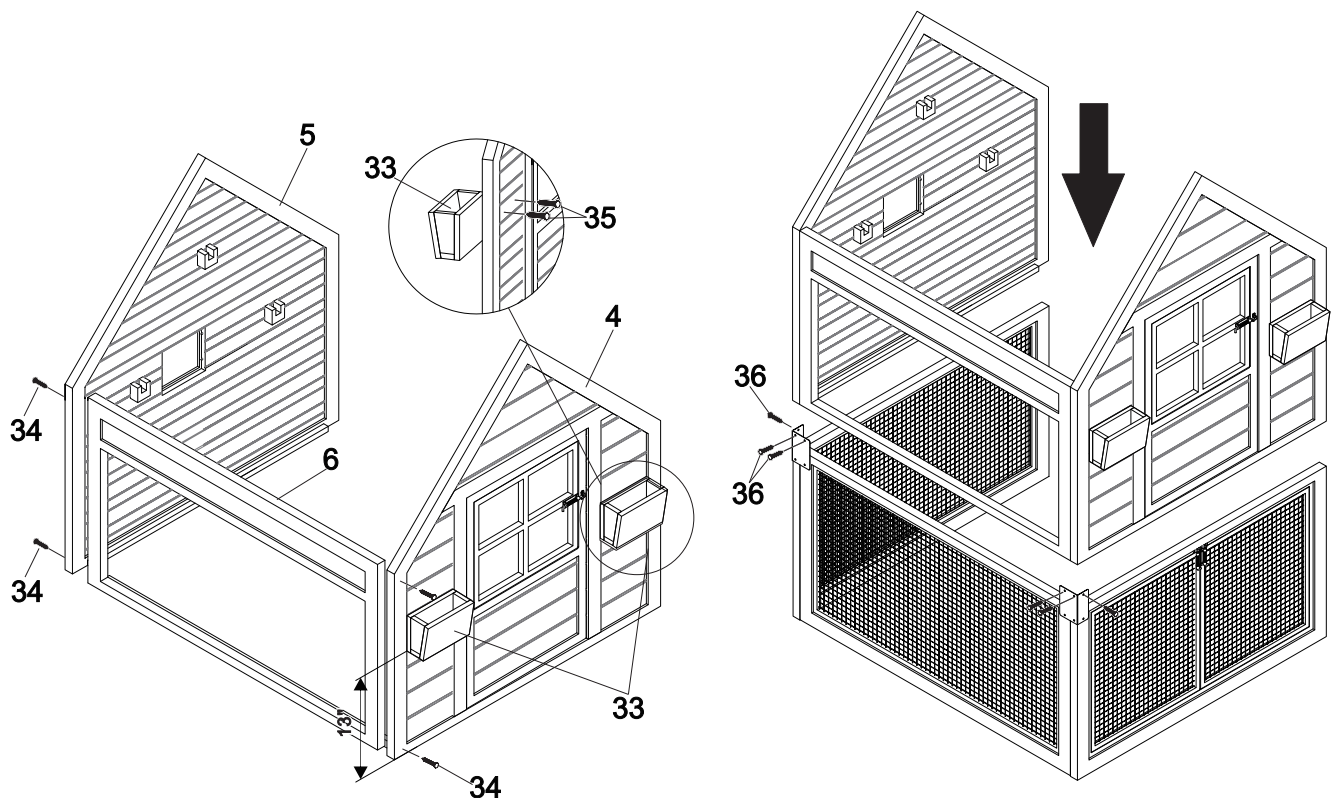

Step 3

- Put PP Board (#8) on top of Floor Board (#7), align right edges of these two boards as below, then sit them on top of the Wood Support Brace on the inside of the wood panels.
- Fix Coop Shoulder Support Rail (#23) on top of Panel (#6) by 5pcs of Screws #36.

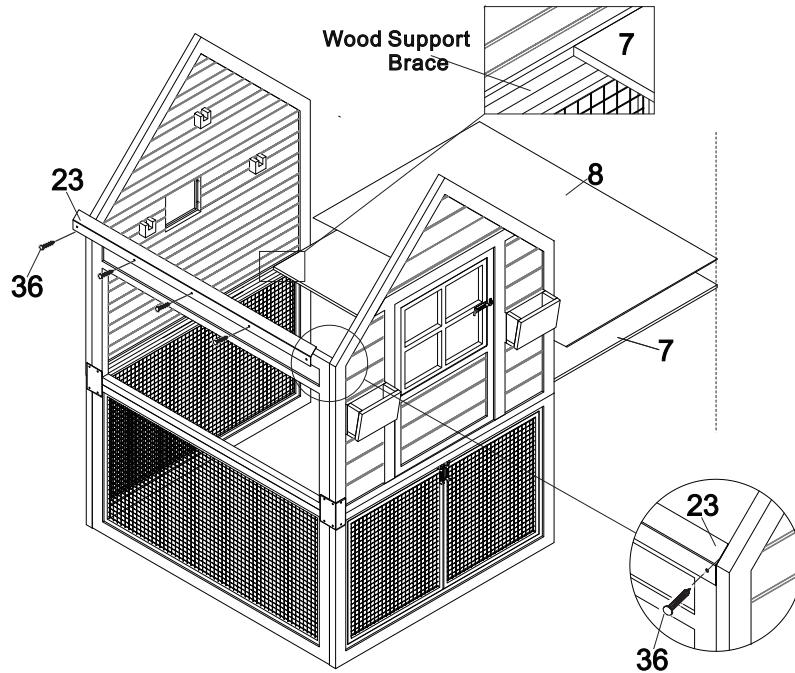

Step 4

- Connect 2pcs Nesting Box side panels (#11), 1pc Door Panel (#12), and 1pc Nesting Box Support Bar (#13) by 6pcs of Screws #34.
- Put Nesting Box Floor (#14) on top of the wood support.
- Insert the two Dividers (#17) into the slots on #14.
- Fix the Nesting Box Roof (#15, #16) by 8pcs of Screws #37. Make sure the two sides are at the same level.

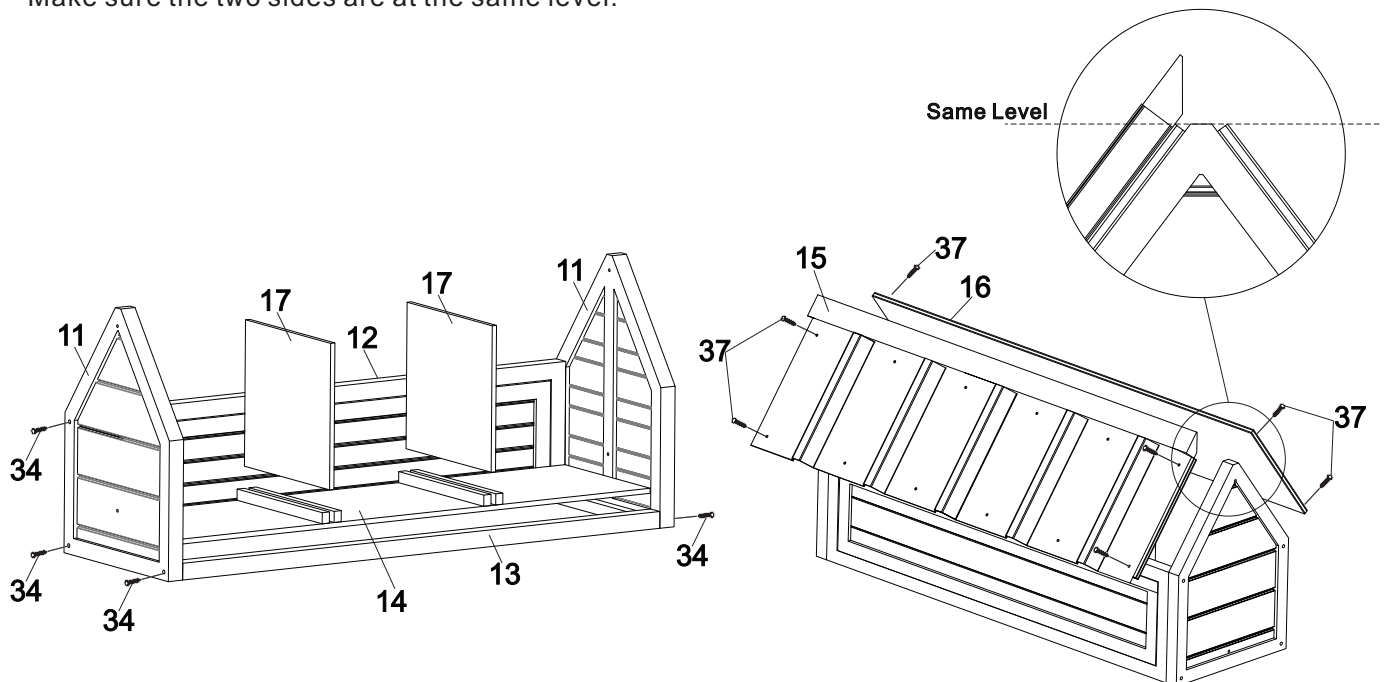

Step 5

- Move the completed Nesting Box into the frame of Wood Panel #6, connect two sides of Nesting Box Roof (#15) with Coop Back Panel #6 by 4pcs of Screws #34 from inside of the coop. Then connect top of Nesting Box Roof (#15) with #6 by 3pcs of Screws #34.
- Note: Please do not let PP board go under the Nesting Box.

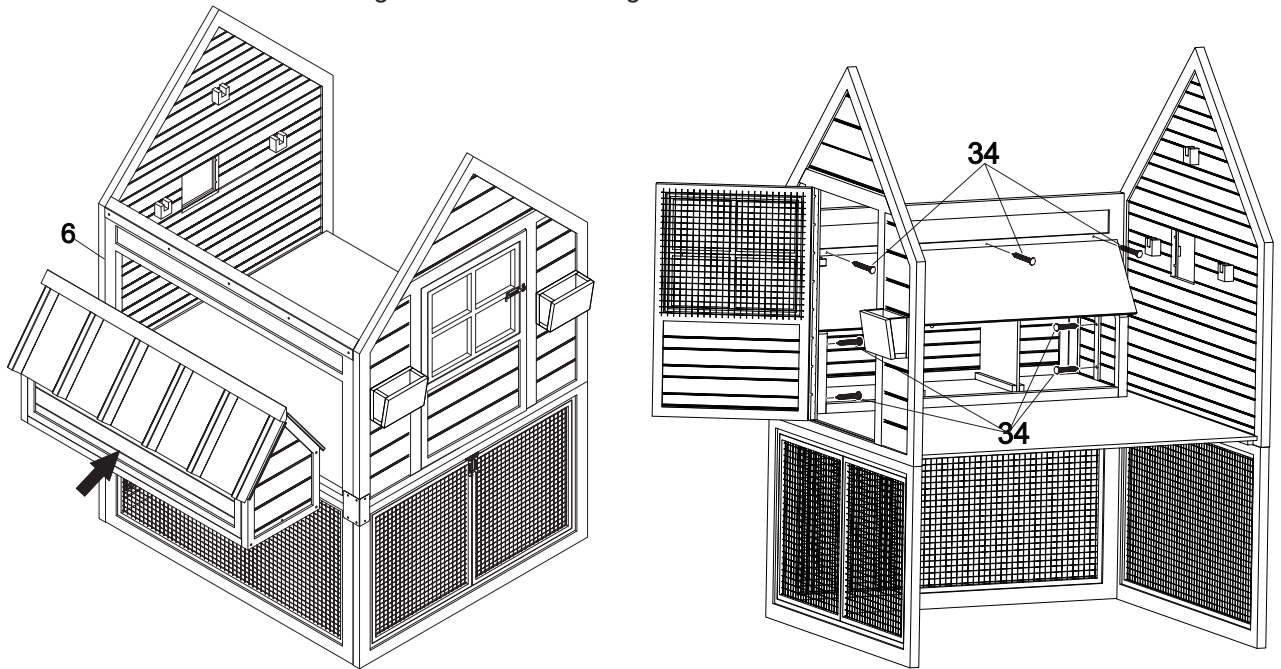

Step 6

- Put 3pcs Roosting Bar (#9) on the brackets.
- Fix the Coop Chicken Access Panel (#10) by 4pcs Screws #34.
- Fix 2pcs of #21, 1pc #23 by 5pcs of #36 Screws.

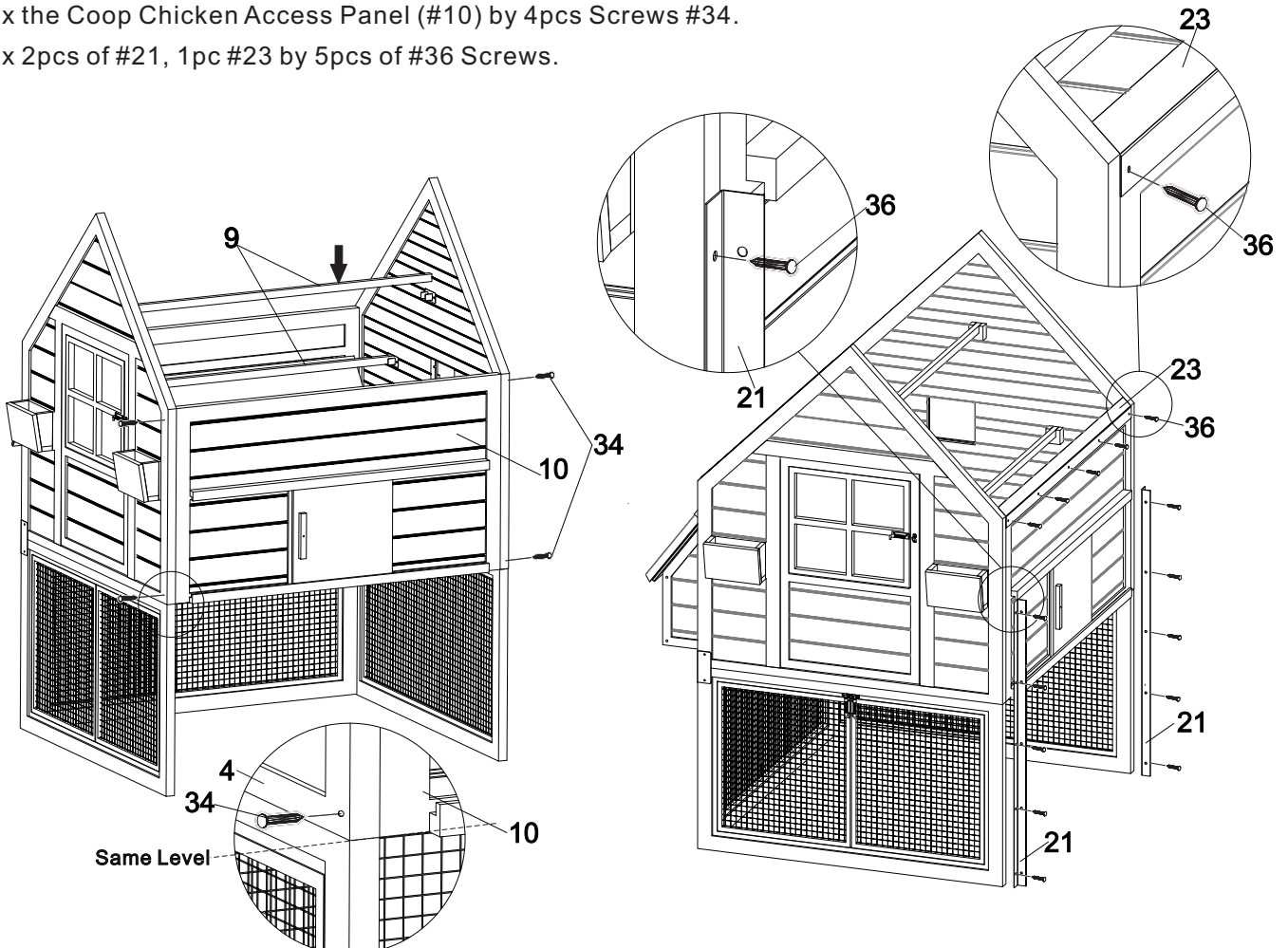

Step 7

- Put Coop Roof Peak Support (#24) on the peak position, fix it by 4pcs Screws #36.
- Assemble the two sides Roof PVC Board (#25, #26) by 24pcs of Screws #39.
- Put the Roof Cover Ridge (#31) on the peak area, and fix it by 14pcs of Screws #37.

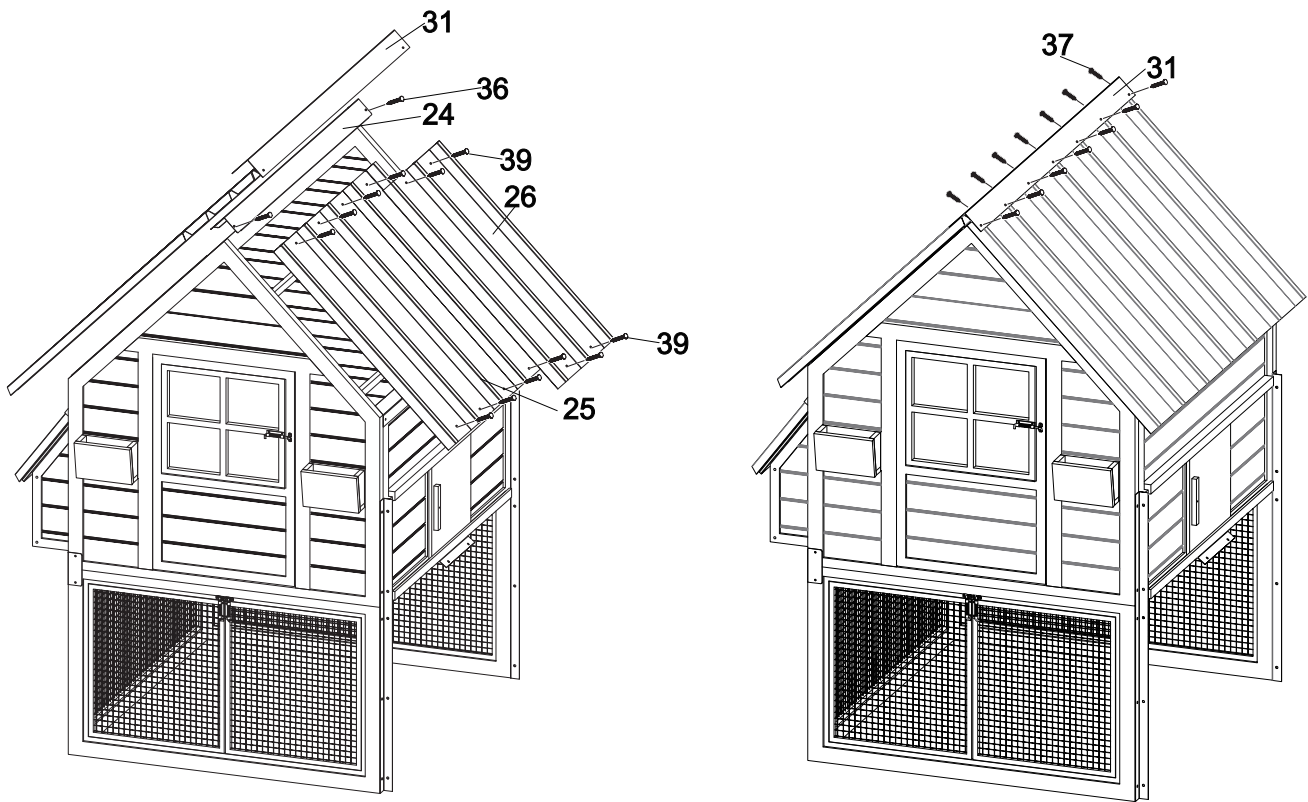

Step 8

- Connect the Run Left Panel (#18A) and Run Right Panel (#18B) to the two Rails (#21) by 10pcs Screws #36.
- Insert the end of Access Door Handle (#46) through the hole on 18A, fix the end on the access door by Bolt #43.
- Fix the Ramp (#22) on the bottom steel of Panel (#10) by Bolt #40 and Nut #42, 2pcs of each.
- Fix the Run Door Panel (#19) between #18A and #18B by 4pcs of Screws #34.
- Fix the Run Roof Support Bar (#30) by 2pcs Bolt (#41).

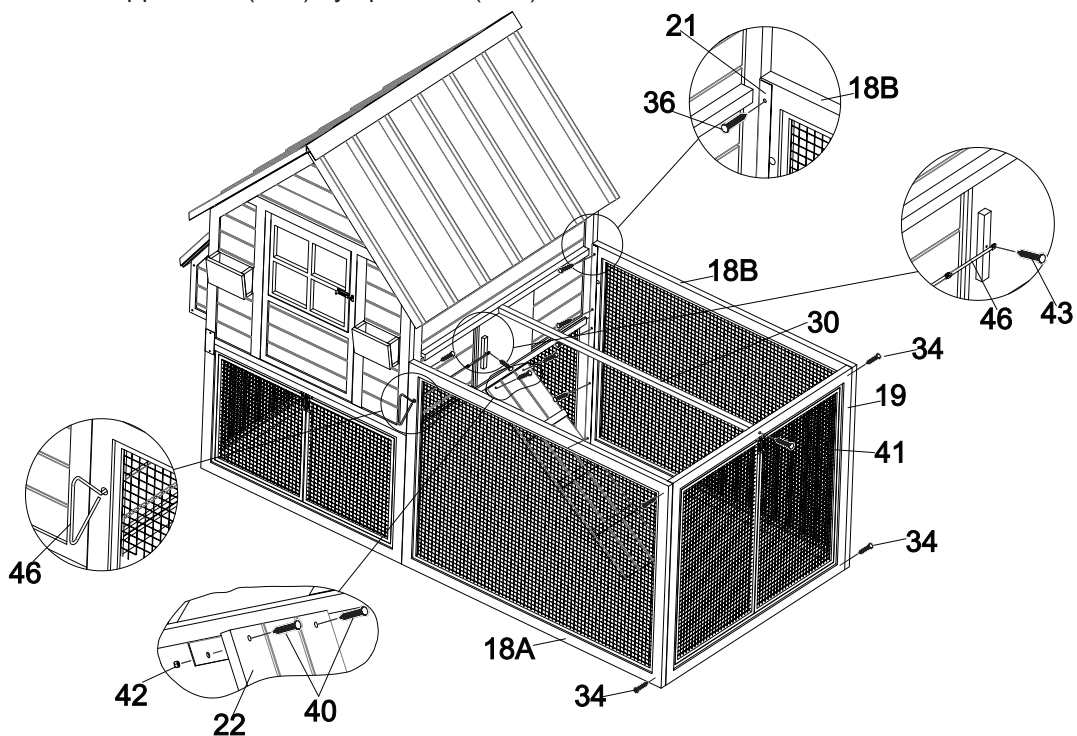

Step 9

- Assemble the Rain Guard (#29) on top of the coop door by 3pcs Screws #36.
- Fix the Run Roof (#27, #28) by 12pcs Screws #37.

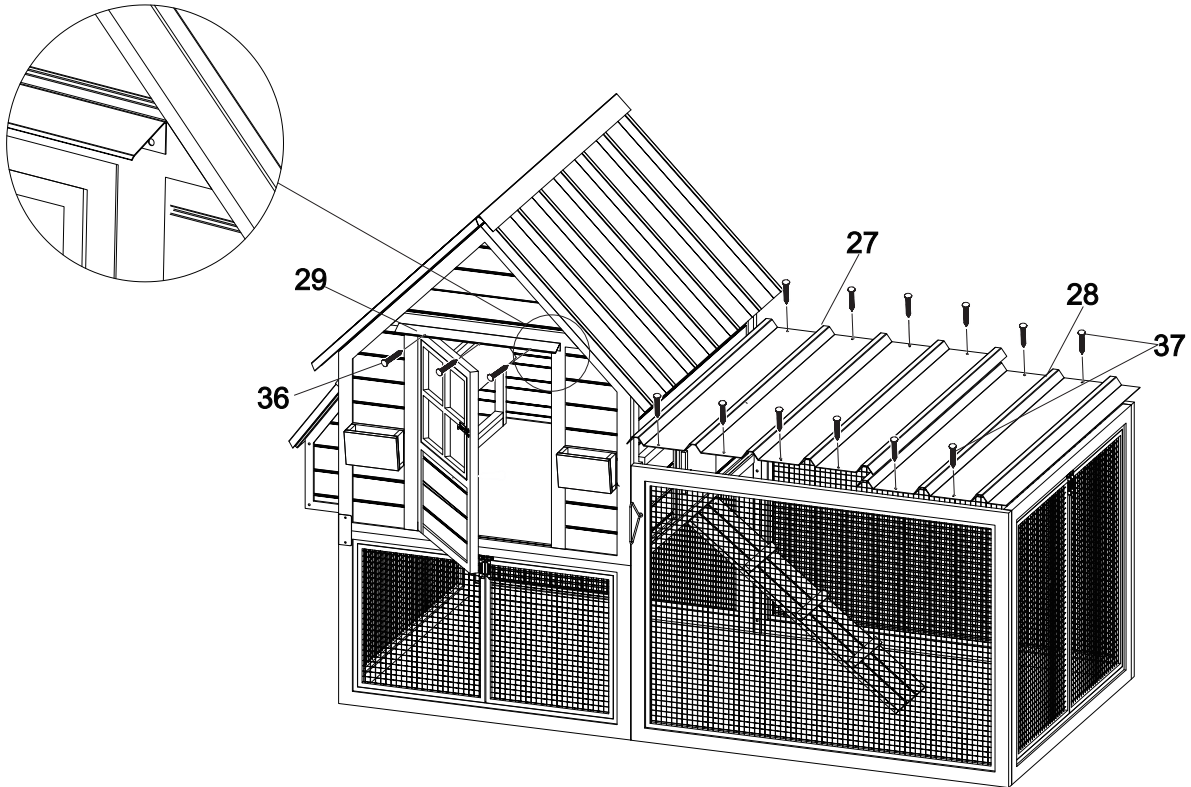

Step 10

- Fix the Nesting Box Rain Guard (#32) by 5pcs Screws #38.

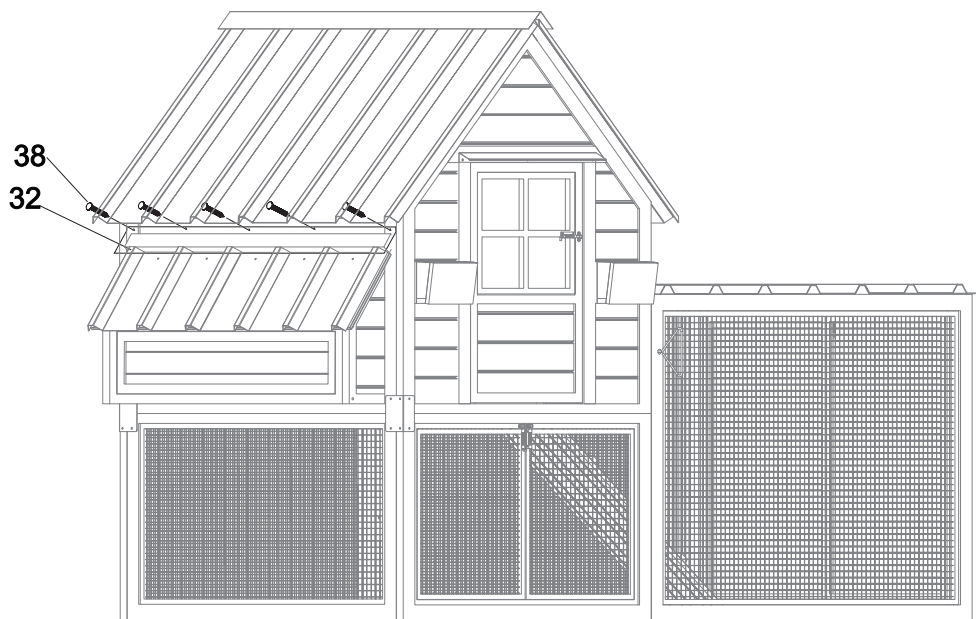

Step 11

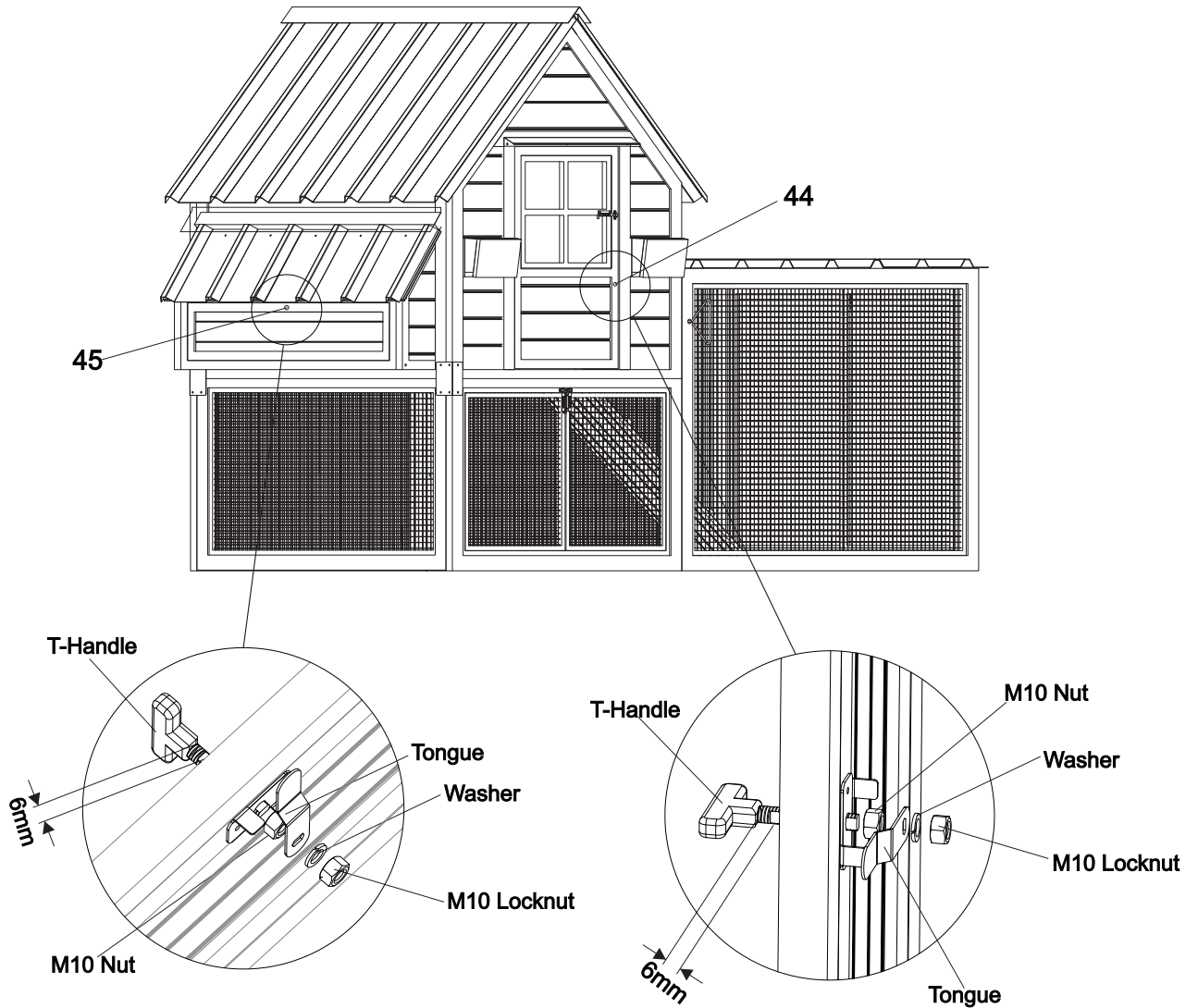

- Follow below instruction to assemble T-Handle Lock (#44, with longer tongue) on Coop Left Panel (#4), and T-Handle Lock (#45, with short tongue) on Nesting Box Door Panel (#12).
- Insert T-handle into the pre-drilled hole on the wood panel, leaving 1/4" space outside. Then from the back of the panel, tighten the M10 nut (not the Locknut) first, then put the Tongue in, make sure the tongue is in the same direction of the T-handle, fix the washer and M10 Locknut and tighten them. When using the lock, please remember that you need to push in the 1/4" gap first before you turn the T-handle. Clockwise to close, counter clockwise to open.

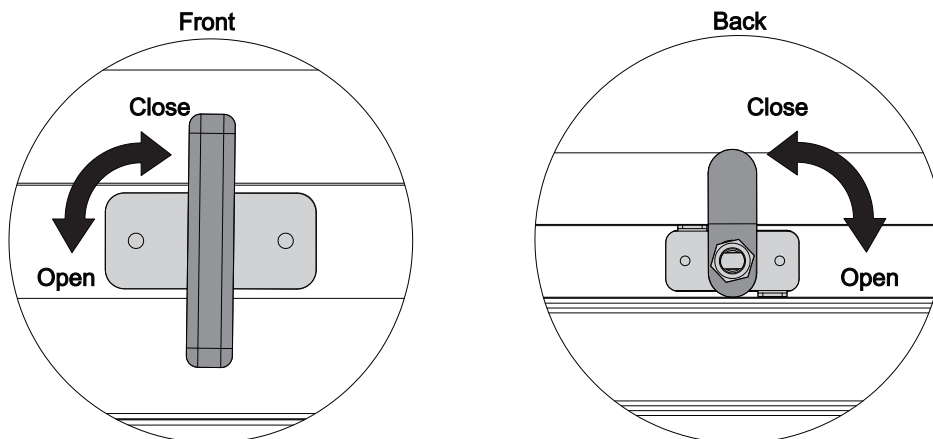

Now the whole assembly is completed.