









ASSEMBLY INSTRUCTION

-  A M3.5*45 18PCS+1
-  B M6*60 4PCS
-  C M6*50 4PCS
-  D M3*18 3PCS+1
-  E M3*16 8PCS+1
-  F M3.5*25 4PCS+1
-  G M3.5*35 14PCS+1
-  H M3.5*55 10PCS+1

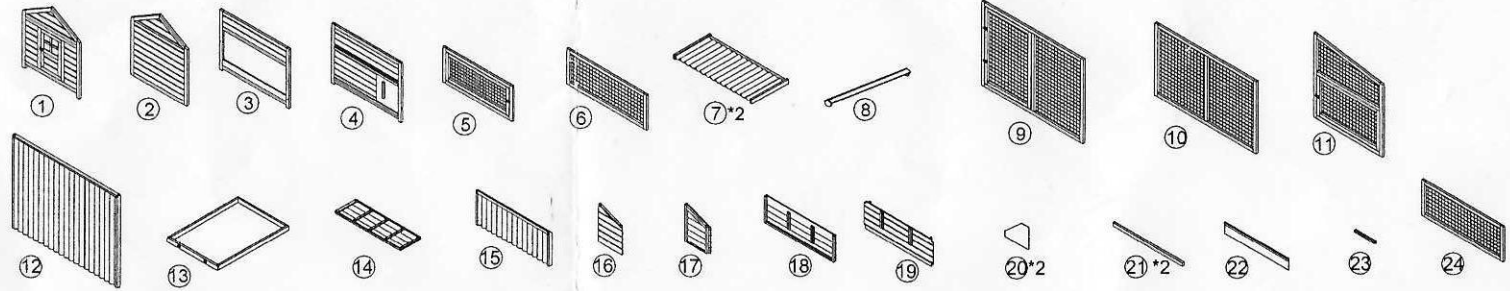

A M3.5*45 12PCS B M6*60 4PCS

A M3.5*45 2PCS
H M3.5*55 2PCS

C M6*50 4PCS

E M3*16 2PCS

A M3.5*45 4PCS H M3.5*55 8PCS

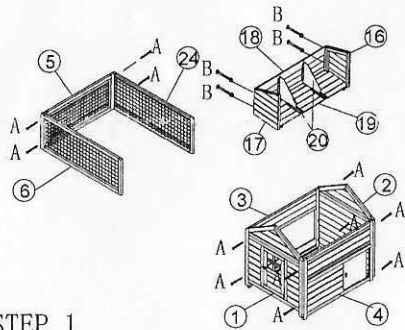

STEP 1

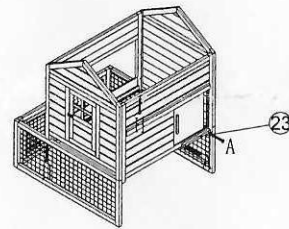

STEP 2

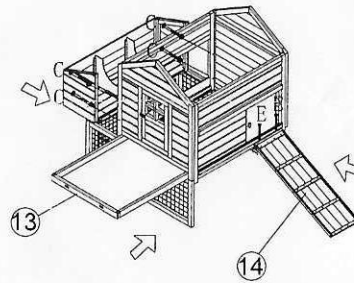

STEP 3

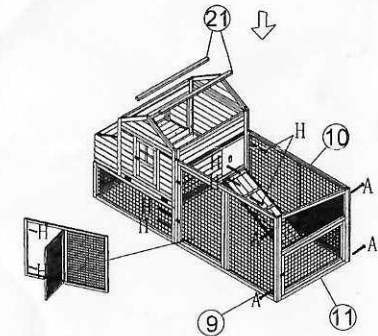

STEP 4

E M3*16 6PCS

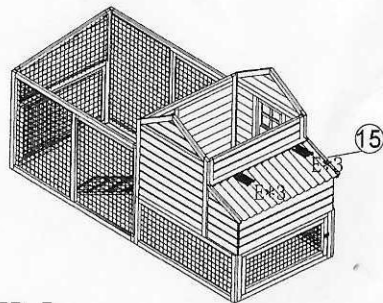

STEP 5

D M3*18 3PCS

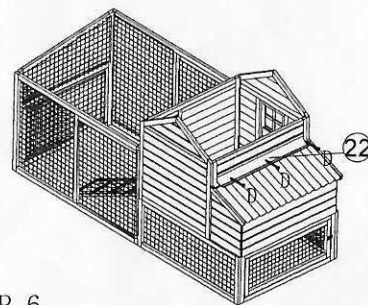

STEP 6

F M3.5*25 4PCS G M3.5*35 8PCS

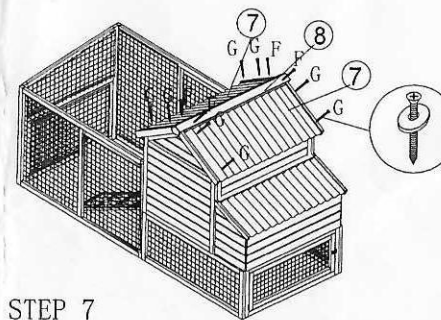

STEP 7

G M3.5*35 6PCS

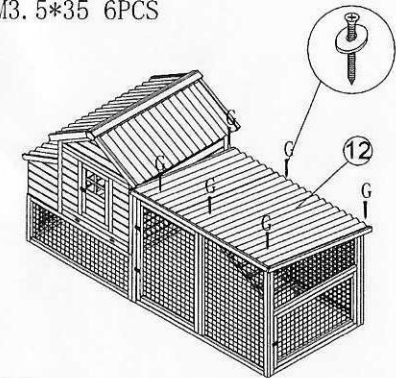

STEP 8