



# SUNTUF<sup>®</sup>

Corrugated Polycarbonate Panels

---

## Installation Guide

---





## Contents

About Palram Americas	1	Canopy Applications	5
Introduction to Suntuf	1	Vertical Installation	6
Transportation, Handling and Storage	2	Greenhouse Applications	7
Chemical Resistance and Fire Hazard Comments	2	Curved Applications	7
Sawing, Cutting and Drilling	2	Miscellaneous Applications	7
Panel Dimensions	3	Technical Support	7
Suntuf Accessories	3	Light Transmission Values for Suntuf Colors	8
Safety Measures	3	Load Support Data	8
Design Considerations and Installation Notes	3	Physical Properties	8
Fasteners	4	Warranty	8
Installation Applications	5		



Miami-Dade County, FL - Approved for Canopy Applications  
Notice of Acceptance (NOA) #: 18-0328.03  
Expires: August 28, 2023

For all specific required details for Miami Dade approved installations, please refer to the Miami-Dade County Notice of Acceptance (N.O.A.) which can be downloaded at [http://www.miamidade.gov/building/pc-search\\_app.asp](http://www.miamidade.gov/building/pc-search_app.asp)



Palram Americas headquarters and state-of-the-art manufacturing facility located in Kutztown, PA.

## About Palram Americas

Palram is one of the world's largest and most advanced manufacturers of polycarbonate, PVC and other thermoplastic sheets for the building industry and for the do-it-yourself market.

Palram Americas is a division of Palram Industries, the world leader in flat and corrugated thermoplastic sheets. With manufacturing, distribution and sales operations reaching across six continents and over 120 countries around the world, Palram is truly a global enterprise.

## Introduction to Suntuf

SUNTUF corrugated sheets offer a variety of light transmission and color options, while also providing maximum impact resistance and a broad service temperature range. SUNTUF is ideal for a wide range of professional and Do-It-Yourself applications.

Transparent & diffused panels make excellent skylights, sidelights, and greenhouse glazing, while colored panels can be used for nearly any roofing or siding (cladding) application.

Lightweight, super tough and easy to install, use SUNTUF to cover just about any type of outdoor structure for increased outdoor living area, storage, or shelter.

### Suntuf is available in the following product groups:

**Suntuf:** Corrugated polycarbonate sheet with co-extruded UV protective layer on one side.

**Suntuf UV2:** Corrugated polycarbonate sheet with co-extruded UV protective layer on both sides.

**Suntuf Solar Control:** Corrugated polycarbonate sheet that transmits selected percentages (20%, 35%, or 50%) of the light energy while keeping the undesired components of the energy spectrum (heat) out. The solar control feature is an integral part of the sheet and will not peel away.

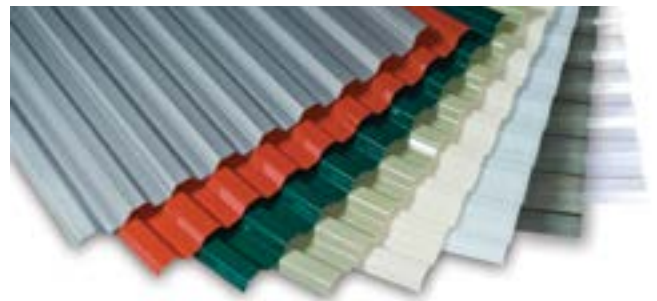

Suntuf is also available in a variety of colors including clear, solar gray, opal white, red brick, misty green, hunter green, smooth cream, and solar control silver. For information regarding the light transmission properties for each of these colors, refer to table on page 8.

Note: if corrugated polycarbonate sheets with an anti-condensate layer are needed, please visit the Dynaglas product page at:

[www.PalramAmericas.com/Dynaglas](http://www.PalramAmericas.com/Dynaglas).

## Transportation, Handling and Storage

Palram recommends the following practices regarding the transportation, handling and storage of Suntuf panels:

1. Transport and store Suntuf panels horizontally, on flat, sturdy pallets, equal or longer than the longest panels. Short panels should be stacked on top of longer ones. The panels should be secured and fastened to the pallet during transportation.
2. Store Suntuf panels in a cool and shaded place, out of direct sunlight. Avoid covering the stack of panels with dark or heat-absorbing materials or objects, to prevent solar heat buildup.
3. When necessary to store panels outdoors, cover the stack with a white opaque polyethylene sheet, corrugated cardboard or other materials that do not absorb or conduct heat. Verify that the entire stack is covered.
4. Suntuf panels are tough, requiring no special care. Nevertheless, Palram recommends some cautionary steps:
  - Avoid stepping or driving on the panel while the panel is on the ground
  - Avoid folding panels during handling and installation
  - To prevent scratching, do not drag the panels on the ground or scrape them against structural elements or other rough objects



## Chemical Resistance and Fire Hazard Comments

1. Suntuf panels are resistant to a variety of chemicals and exhibit limited resistance to a second group of chemicals. A third group of chemical may attack and damage the panel. Degree and severity of damage depends on chemical type and duration of exposure. [Visit www.PalramAmericas.com/tech](http://www.PalramAmericas.com/tech) for more information.
2. Choose only sealants and adhesives that are compatible with Suntuf polycarbonate sheets. Contact sealant / adhesive manufacturer to verify compatibility with polycarbonate.
3. Suntuf panels will melt down at approximately 400°F, generating openings for smoke release in the event of fire.

## Sawing, Cutting and Drilling

1. Suntuf panels can be cut or sawed by manual or power tools. A bench / table circular saw is best for straight long cuts. For better results, cut a few panels together. Portable circular saws are suitable for on-site straight cuts. Fine toothed blades recommended for cutting plastics (particularly polycarbonate) should be used. Consult the blade manufacturer for suitability. Cutting should be done with blades mounted in reverse direction, spinning at high speeds, and material fed at a slow rate. Panels should be clamped during sawing to avoid vibration. Avoid intersecting cuts. If an intersecting cut must be made, drill a hole at the intersection point and cut the panel up to the hole. A jigsaw may be used for cutting a limited length of irregular or curved lines. Hand tools such as handsaw, metal shears or hand-held cutting knives can be used for localized, limited work.
2. Drilling is done using a power drill with regular high-speed steel bits intended for metal, rotating at about 1,000 RPM. Better results with Suntuf are achieved using bits ground to shallower tip angle than for metal. Clamp the drilled panel down to avoid vibrations or movement during operation.
3. Keep all cutting and drilling areas clean. Blow away saw dust and drilling debris with compressed air.

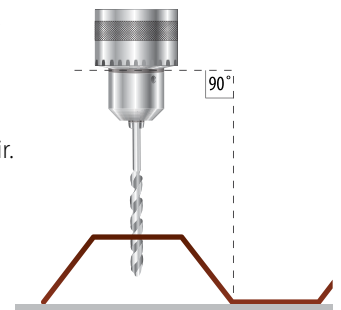
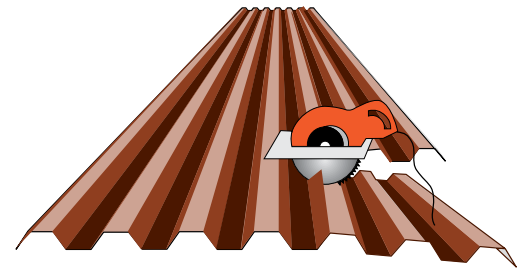

## Panel Dimensions

Suntuf panels use the following corrugation pattern, referred to as profile name Greca 76. This profile consists of a repeated squared off trapezoidal shape and should not be confused with the round corrugation profiles of other Palram Americas products. Suntuf panels are available in widths of 26" (at 8', 10', and 12' lengths) and 49.6" (at 8', 12', and 16' lengths).

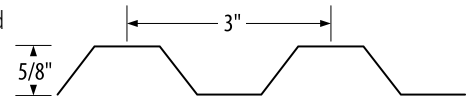

## Suntuf Accessories

The following accessories are available for use in your Suntuf installation. Note that these accessories are made for use with the Suntuf profile panels and may not be compatible for use with other Palram Americas Inc.'s products.

1. Suntuf Ridge Cap Flashing (4'-2" L x 12" W)
2. Suntuf Side Ridge Flashing (4'-2" L x 7" W)
3. Suntuf Wall Connector Flashing (4'-2" L x 8" W)
4. Suntuf Vertical Closure Strip, plastic (7/8" H x 1 3/16" W x 24" L);  
Note: limited—and decreasing—availability in wood (7/8" H x 1 3/16" W x 24" L).
5. Suntuf Horizontal Closure Strip, available in plastic (3/4" H x 7/8" W x 24" L) and white foam (3/4" H x 7/8" W x 36" L). Note: limited—and decreasing—availability in wood (3/4" H x 7/8" W x 24" L).



For usage and placement please see pages 5 & 6.

## Safety Measures

The following safety measures should be followed during and after installation of Suntuf panels.

1. Use ladders, crawling boards and other safety equipment required for safe installation. Use all safety measures required according to local safety regulations.
2. Don't step on installed panels between support members for fear of falling. Rather, use a sturdy board adequate to support your weight and long enough to span at least three structural members.
3. Never leave Suntuf panels unattended on the roof until all the required fasteners have been appropriately installed or the panels secured to the supporting structure.



## Design Considerations and Installation Notes

### Before You Begin Your Project

Make sure the color of all panels match. Be sure Panel and Horizontal Closure Strip profiles fit together and that all accessories match the Suntuf profile. Snow, wind and weather loads should be considered when designing the slope degree of your structure. Before installation, check local building codes for relevant specifications and recommendations. Follow local codes at all times.

### Pitch

This is the amount of height in inches the rafter rises over a 12" run for roofing applications. The minimum recommended slope for Suntuf is 1-1/2" in 12". When installed at a lower pitch, additional sealing should be applied to ensure weather resistance.

### Purlins / Cross Supports

Cross supports (purlins) must be no more than 36" apart for Suntuf. This is the maximum recommended spacing. For most typical installations however 24" is recommended to give the best balance of economy, light transmission and structural support.

## Sealants

Palram does not manufacture a sealant for use with Suntuf. When choosing a sealant it is important to contact the sealant manufacturer to verify its compatibility with polycarbonate prior to using.

## Closure Strips

Suntuf's closure strips are made from wood, plastic, or foam. Foam closures are most suitable for enclosed structures where energy efficiency is a concern.

## Ventilation

With all Suntuf installations, proper ventilation is suggested to minimize heat buildup and condensation.

Depending on regional conditions this may include incorporating an open air aspect to the structure's design or the installation of power fans. For more detailed information about condensation mitigation, visit [http://www.palramamericas.com/Suntuf\\_docs](http://www.palramamericas.com/Suntuf_docs). Palram Americas is not responsible for the failure to account for this important design aspect.

## Panel Orientation

Install panels with the label side facing up toward the sky (sheet corrugations at each side will then facedown). This will ensure that the UV protection layer is on the side facing the sun. Failure to follow this advice will result in the eventual discoloration of the panel.

## Care and Maintenance

Avoid contact with chemicals, paints, adhesives or other synthetic materials that are incompatible with polycarbonate. Never use glass cleaners with ammonia, or ammonia based products. Clean with lukewarm soapy solution using a soft cloth or sponge. Do not use abrasive brushes as these will mark the surface. See form 2203 - PC Care and Maintenance Instructions for more detailed information, you can download the form at: [www.palramamericas.com/Suntuf\\_docs](http://www.palramamericas.com/Suntuf_docs).

## Fasteners

Palram recommends the use of Palram/Suntuf brand EPDM washed fastener only. Palram fasteners for Suntuf panels are tested and approved to be compatible with polycarbonate, whereas other brands may not be. Incompatible washers can result in panel failure that is not covered by warranty. Contact Palram for information about availability of optional larger washers if local building codes prescribe their use, or if installation is in high wind area.

Pre-drill all fastener holes with a 1/4" drill bit for Woodtite and Metaltite fasteners to accommodate for the thermal movement of the panel. Over-drill by an extra 1/16" for other fastener diameters. Failure to accommodate for thermal movement will cause buckling of the sheet.

Use 2" fasteners for all roof applications. 1" fasteners are adequate for vertical applications (i.e., side walls, end walls, and partitions).



2" Woodtite Fasteners



2" Metaltite Fasteners

DO NOT Over-tighten fasteners causing the rubber washer to compress. Tighten all fasteners until they are "snug." If the EPDM washer becomes deformed, the fastener is too tight.

Drive fasteners perpendicular to the Suntuf face (see illustration given to the right). Tighten moderately by hand or with an adjustable torque power screwdriver. NEVER use an impact wrench / driver for fastening Suntuf.





## Installation Applications

Suntuf polycarbonate panels are used in a variety of applications. Following are instructions for the most common uses of Suntuf panels. If the application you are considering for these panels is much different from those depicted here, contact Palram America's technical support for guidance.

## Canopy Applications

The most common application for Suntuf panels is usage in canopy applications (patio cover, awnings, etc.). Shown here are two approaches for installation. The approaches are shown as the "Purlins over Rafters" configuration and the "Integrated Purlins" configuration.

### Purlins over Rafters Configuration

This approach is the simplest to employ and is found in Palram America's "do-it-yourself" documentation. It involves installing the purlins (horizontal supports) on top and across the rafters. Vertical closure strips are confined to sealing the edges. Utilizing closure strips, attach fasteners on the crown of every other rib in the horizontal direction. In high wind areas, fasten on the crown of every rib. This approach offers the best combination of installation ease and product performance.

### Integrated Purlins Configuration

This approach involves "blocking-in" horizontal supports, and may be desired for some installations. With this method it is also possible to place vertical closure strips on rafters throughout the installation if desired. As with the previous configuration, utilizing closure strips, attach fasteners on the crown of every other rib in the horizontal direction. In high wind areas, fasten on the crown of every rib.

**Note:** The illustrations depicted here are for installation purposes only and not a reference as to how to build the supporting structure. The supporting structure needs to be constructed in accordance to local building codes and Palram Americas will not be responsible for the design / function of the structure. Please consult a structural engineer in your area.

### Purlins Over Rafters Configuration

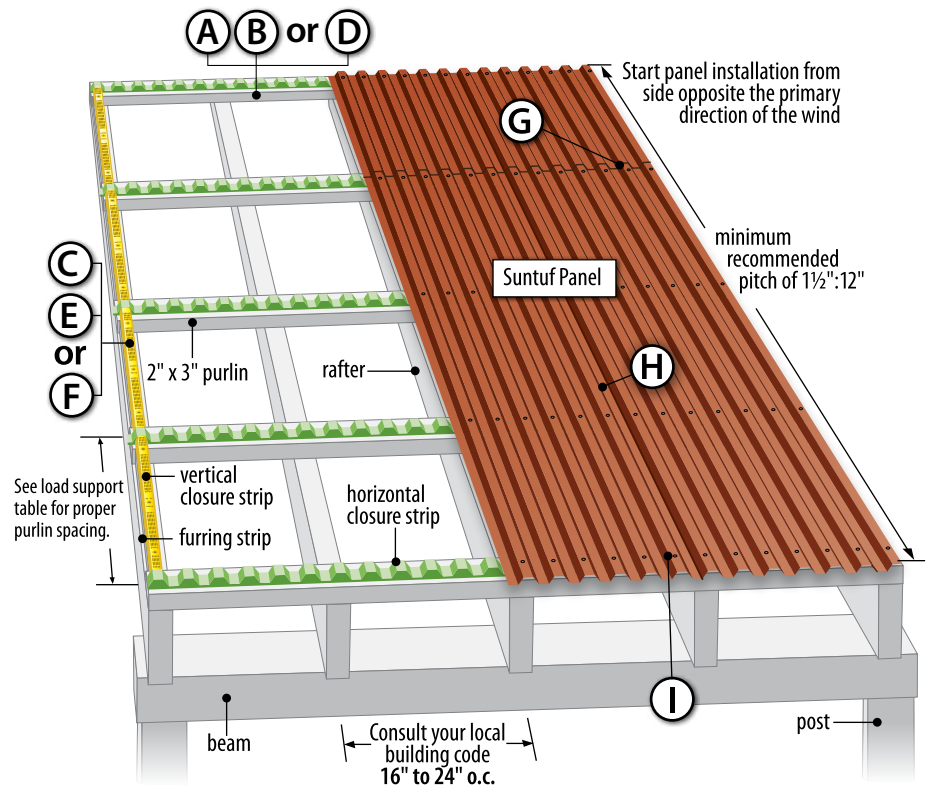

### Integrated Purlin Configuration

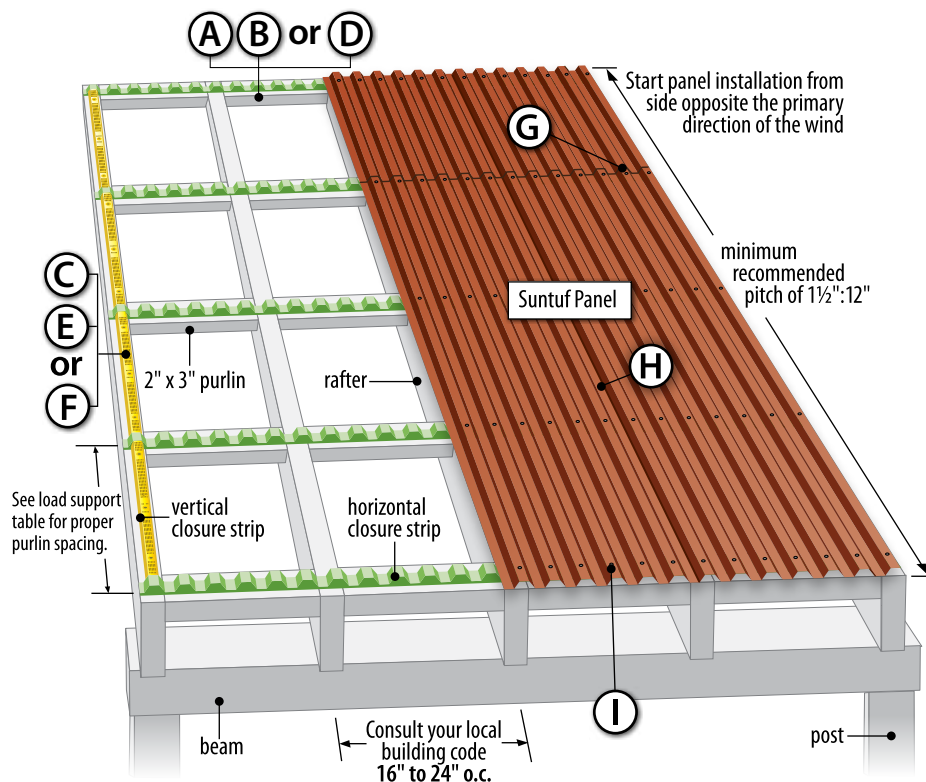



## Details

Details applicable to each configuration are shown below.

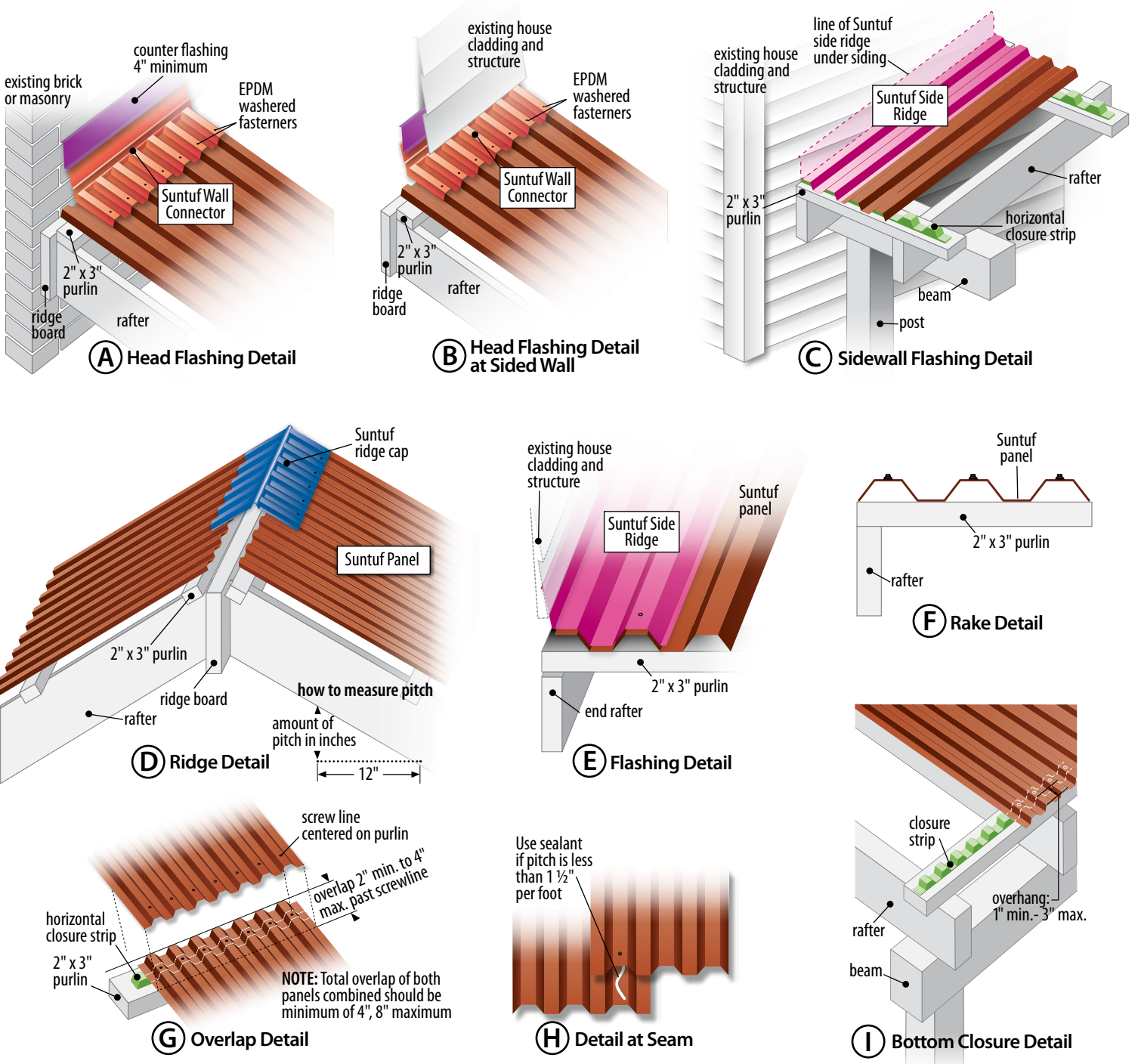

## Vertical Installation

Vertical Installation of Suntuf, for side or end walls as an example, is essentially the same as with roofing / canopy applications. Fastener spacing and application is the same, except that fasteners are to be installed in the corrugation valleys (as opposed to the crests). Closure strips are not required for vertical installations, unless the structure is totally enclosed and energy efficiency is a concern.

## Greenhouse Applications

Suntuf polycarbonate panels make excellent cladding for do-it-yourself greenhouse projects, such as season-extenders, cold frames and more. While installation for such projects generally follows the same procedures as those previously outlined, please be aware that condensation formation and dripping is common for enclosed, humid environments like greenhouses. If condensation formation or dripping is not objectionable, standard Suntuf may be used. However, if condensation formation and dripping is a concern, consider the use of Palram's DynaGlas product instead.

DynaGlas features a proven anti-condensate coating that helps to minimize fogging and promotes the flow of condensation on the inside of the panel. As a result, droplets are minimized and panel clarity is increased, allowing for greater overall light transmission. It is important to account for condensation flow in the design of the structure. Without the proper slope and some form of condensation collection and removal system, dripping will occur at purlins or other supporting members. Many commercial and professionally manufactured hobby greenhouse structures are designed to manage condensate control and removal. For information about such structures and DynaGlas, consult your preferred greenhouse manufacturer or dealer.

For large scale commercial greenhouse projects, Palram America's Horticulture division should be consulted for additional design considerations, specialized products for commercial greenhouse such as [DynaGlas](#) & [ThermaGlas](#), installation instructions, and the availability of specialized greenhouse-specific accessories.

## Curved Applications

When covering curved structures, it is possible to set the sheets on an arched framework so that they arch within the range of elasticity of the sheets without inducing stress. The minimum radius of the arch created is 20 feet.

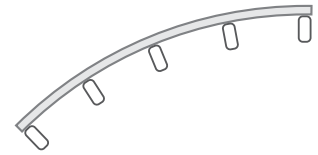

## Miscellaneous Applications

While this document provides guidance for the most common applications for Suntuf, there are many other possible uses not accounted for here. If you have any questions regarding the use or installation in a particular application, contact Palram Americas for further assistance..

## Technical Support

Palram Technical Support is available weekdays 9am to 5pm EST by calling 800-999-9459.

Questions may also be e-mailed to [Contactus.USA@palram.com](mailto:Contactus.USA@palram.com)

## Light Transmission Values for Suntuf Colors

Color		Color	Light Transmission
Transparent	90%	Misty Green	20%
Opal White	45%	Hunter Green	Less than 5%
Solar Gray	35%	Red Brick	Less than 5%
Smooth Cream	30%	Solar Control Silver	20%

## Load Support Data

When designing the underlying structure for your application, be sure to account for the following loading data:

### Suntuf Panels Support the Following Loads:

Pounds Per Square Foot	20	30	40	50
Cross Support Bracing	36"	30"	24"	16"

## Physical Properties

A detailed overview of Suntuf physical properties can be downloaded at:

[http://www.PalramAmericas.com/Suntuf\\_Docs](http://www.PalramAmericas.com/Suntuf_Docs)

## Warranty

Suntuf Polycarbonate Panels carry a limited lifetime warranty not to lose more than 10% of their light transmission (when tested in accordance with ASTM B-1033-77). They are also warranted for ten years against impact damage (including hail). For complete text of the Suntuf warranties visit the following web page or contact Palram Americas at 800-999-9459.

[http://www.PalramAmericas.com/Suntuf\\_Docs](http://www.PalramAmericas.com/Suntuf_Docs)

Inasmuch as Palram Americas has no control over the use to which others may put the product, it does not guarantee that the same results as those described herein will be obtained. Each user of the product should make his own tests to determine the product's suitability for his own particular use including the suitability of environmental conditions for the product. Statements concerning possible or suggested uses of the products described herein are not to be construed as constituting a license under any Palram Americas patent covering such use or as recommendations for use of such products in the infringement of any patent. Palram Americas or its distributors cannot be held responsible for any losses incurred through incorrect installation of the product. In accordance with our company policy of continual product development you are advised to check with your local Palram Americas supplier to ensure that you have obtained the most up to date information.

**Palram Americas** reserves the right to change product specifications and/or information contained in this brochure without notice.



**PALRAM AMERICAS**  
Kutztown, PA, USA  
Tel: 610.285.9918  
Fax: 610.285.9928  
[palramamericas@palram.com](mailto:palramamericas@palram.com)

