

## LIMITED WARRANTY

Airbase Industries (ABI) makes every effort to insure that its products meet the highest quality and durability standards.

ABI warrants, to the original retail consumer, a Limited Lifetime Warranty, that this spray gun is free from material defects.

1 year limited warranty on all parts, excluding those from common wear and tear (tips, air caps, needles, gaskets, & seats which have a 90 day warranty).

Product Serial number: \_\_\_\_\_

**Note:** If the product does not have a serial number, record the month and year of purchase instead.

**Note:** Some parts are listed and shown for illustration purposes only, and are not available for individual purchase as replacement parts.

For technical questions, please call 866-294-4153

## SAVE THESE INSTRUCTIONS



EATSPGPC1P

## Professional Clear Coat HVLP Pneumatic Spray Gun



OWNER'S MANUAL & SAFETY INSTRUCTIONS

### NOTICE

#### CLEAN IMMEDIATELY

Clean the spray gun IMMEDIATELY after use. Delayed or inadequate cleaning will permanently clog the spray gun.

### ⚠ WARNING ⚠

Read this manual completely before operating this product. Failure to do so may result in serious injury.

**SAVE THIS MANUAL.**

“DO NOT RETURN TO STORE”

FOR Technical Assistance or Parts

CALL 866.294.4153

“DO NOT RETURN TO STORE”

FOR Technical Assistance or Parts

CALL 866.294.4153

## PARTS LIST

No.	Description	QTY
10	Atomizing module	1
5000	Air cap gasket	1
5001	Locating ring	1
5002	Air cap	1
5003	Locating ring sealing gasket	1
5004	Locating ring sealing ring	1
20	Fluid nozzle assembly	1
30	Fluid nozzle sealing ring	1
40	Air baffle	1
50	Trigger valve sealing screw	1
60	Trigger valve gasket	1
70	E-ring d=4	2
80	Trigger washer	2
90	Trigger pin	1
100	Trigger	1
110	Needle guide	1
120	Trigger gasket	1
130	Air inlet	1
140	Pattern control plug	1
150	Pattern control seat	1
160	Pattern control rod	1
170	Sealing ring	1
180	Pattern control knob	1
190	Cross recessed screw M4*8	1
200	Air valve knob	1
210	O-ring 7.8*2.3	1
220	Air control valve	1
230	Cross screw M4*10	1
240	Trigger valve spring	1
250	Trigger valve switch	1
260	Trigger valve stem	1
270	Air valve pin	1
280	Fluid needle sealing ring	1
290	Packing bushing	1
300	Fluid needle	1
310	Fluid control spring	1
320	Fluid control seat	1
330	Fluid control knob	1
340	Gun body	1
350	Fluid inlet gasket	1
360	Fluid inlet	1
370	Plastic cup assembly	1
380	Push in filter	1
390	Hook	1
400	Hexagon bar wrench S4	1
410	Hexagon bar wrench S2	1
420	Brush	1
430	Wrench	1

## SAFETY INSTRUCTIONS

The warnings and precautions discussed in this manual cannot cover all possible conditions and situations that may occur. It must be understood by the operator that common sense and caution are factors which cannot be built into this product, but must be supplied by the operator.



**WARNING**

*When using air tools, basic precautions should always be followed.*

### WORK AREA

1. **Keep the work area clean and well lit.** Cluttered benches and dark areas increase the risk of electric shock, fire, and injury to persons.
2. **Keep bystanders, children, and visitors away while the tool is in operation.** Distractions may result in loss of control of the tool.

### PERSONAL SAFETY



1. **Stay alert.** Watch what you are doing and use common sense when operating the tool. Do not use the tool while tired or under the influence of drugs, alcohol, or medication. A moment of inattention while operating the tool increases the risk of injury to yourself or other people.
2. **Dress properly.** Keep hair, clothing, and gloves away from moving parts. Do not wear loose clothing or jewelry. Contain long hair. Loose clothes, jewelry, or long hair increases the risk of injury to persons as a result of getting caught in moving parts.
3. **Keep proper footing at all times.** Do not overreach. Proper footing enables better control of the tool in unexpected situations.
4. **Use appropriate safety equipment.** Wear heavy-duty work gloves and a NIOSH-approved respirator during use. Non-Skid safety shoes, and a hard hat must be used in the applicable conditions.
5. **Protect your eyes.** Always wear ANSI-approved safety goggles to protect your eyes.

# SAFETY INSTRUCTIONS

## TOOL USE AND CARE

1. **Do not force the tool.** Use the correct tool for the application. The correct tool will do the job better and safer at the rate for which the tool was designed.
2. **Before making any adjustments, changing accessories, or storing the tool, disconnect the tool from the air source.** Such preventative measures reduce the risk of starting the tool unintentionally. Turn off and detach the air supply, safely discharge any residual air pressure, and release the throttle and/or turn the switch to its off position before leaving the work area.
3. **When the tool is idle, store it out of the reach of children and other untrained people.** This tool can be dangerous in the hands of untrained users.
4. **Check for misalignment or binding of moving parts, breakage of parts, and any other condition that affects the tool's operation.** If damaged, have the tool serviced before using. Many accidents are caused by poorly maintained tools. There is a risk of bursting if the tool is damaged.
5. **Use only accessories that are identified by the manufacturer for the specific tool model.** Use of any accessory not intended for use on the specific tool model increases the risk of injury to persons.

## SERVICE

1. **If the tool needs serviced, it must be completed only by a qualified repair personnel.**
2. **When servicing a tool, use only identical and authorized replacement parts.**
3. **Use only lubricants supplied with the tool or specified by the manufacturer.**

## NOTICE

Clean the spray gun **IMMEDIATELY** after use. Delayed or inadequate cleaning will permanently clog the spray gun.

# ASSEMBLY DIAGRAM

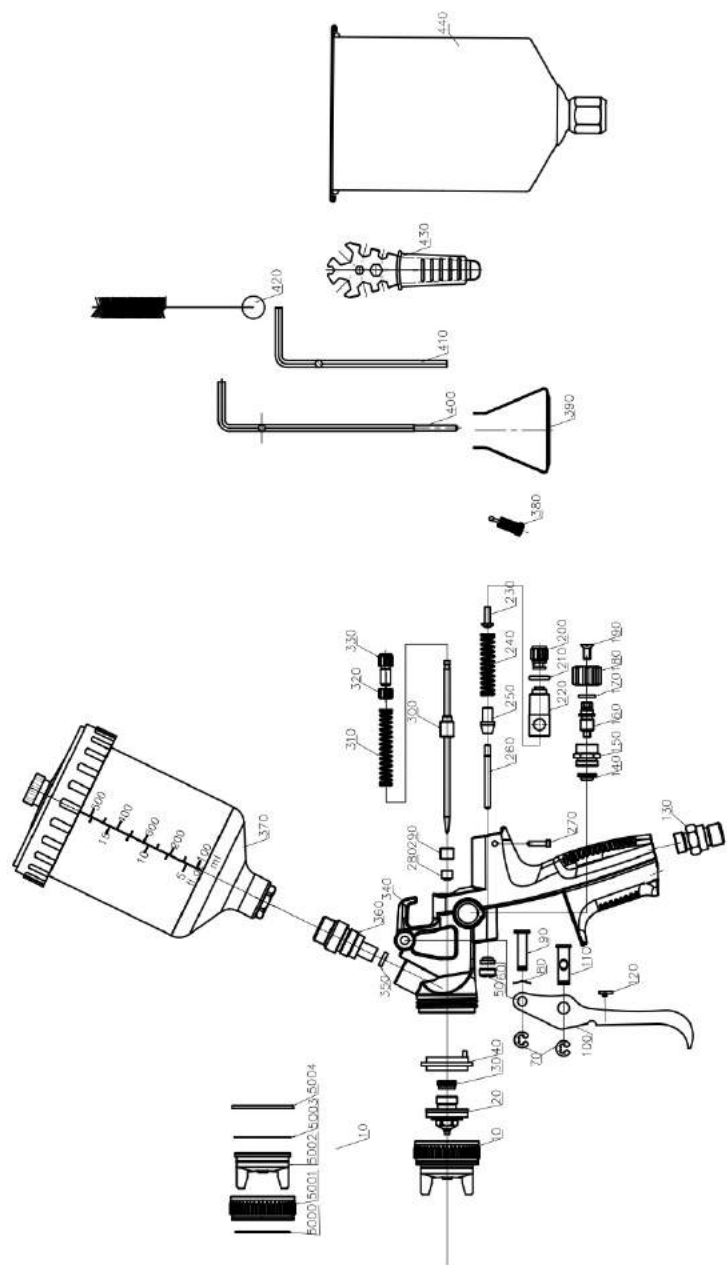

## TROUBLESHOOTING - SPRAY PATTERN DIAGNOSIS

NOTE: The drawings on the left below resemble symptoms of spray pattern problems. Refer to the accompanying possible causes and likely solutions.

PROBLEM	POSSIBLE CAUSES	LIKELY SOLUTIONS
Sputtering Spray	<ol style="list-style-type: none"> <li>1. Low paint level</li> <li>2. Cup tipped</li> <li>3. Clogged air vent</li> <li>4. Loose fluid inlet connection</li> <li>5. Loose/damaged fluid tip/seat.</li> </ol>	<ol style="list-style-type: none"> <li>1. Refill</li> <li>2. Hold upright</li> <li>3. Clean air vent hole</li> <li>4. Tighten fluid inlet connection</li> <li>5. Adjust or replace fluid tip</li> </ol>
Will not spray	<ol style="list-style-type: none"> <li>1. No pressure at spray gun</li> <li>2. Fluid knob not open enough</li> <li>3. Fluid too thick</li> </ol>	<ol style="list-style-type: none"> <li>1. Check air hoses</li> <li>2. Open fluid knob</li> <li>3. Thin fluid or increase air pressure (Do not exceed maximum)</li> </ol>
Overspray (Paint drifting to unintended objects)	<ol style="list-style-type: none"> <li>1. Dirty tip</li> <li>2. Broken fluid needle spring</li> <li>3. Worn or damaged tip</li> </ol>	<ol style="list-style-type: none"> <li>1. Clean tip</li> <li>2. Replace fluid needle spring</li> <li>3. Replace tip and/or needle</li> </ol>
Air leaking from nozzle	<ol style="list-style-type: none"> <li>1. Dirty air valve/seat</li> <li>2. Sticking air valve</li> <li>3. Damaged air valve spring</li> <li>4. Worn/damaged air valve/seat</li> <li>5. Bent valve stem</li> </ol>	<ol style="list-style-type: none"> <li>1. Clean air valve/seat</li> <li>2. Lubricate air valve/seat</li> <li>3. Replace air valve spring</li> <li>4. Replace air valve</li> <li>5. Replace valve stem</li> </ol>

## SPECIFIC SAFETY INSTRUCTIONS

1. Do not spray at people or animals.
2. Do not exceed the maximum air pressure.
3. Do not spray near open flames, pilot lights, stoves, heaters, the air compressor, or any other heat source. Most solvents and coatings are highly flammable, particularly when sprayed. Maintain a distance of at least 25 feet from the air compressor. If possible locate the air compressor in a separate room.
4. Read all of the information concerning coating products and cleaning solvents. **Do not use chlorinated solvents (e.g. 1-1-1 trichloroethylene and dichloromethane, also known as methylene chloride) to clean spray guns. Many spray guns contain aluminum, which reacts strongly to chlorinated solvents.** Contact the solvent or coating manufacturer as needed regarding potential chemical reactions.
5. Industrial applications must follow OSHA requirements.
6. Spraying hazardous materials may result in serious injury or death. Do not spray pesticide, acid, corrosive material, fertilizer, or toxic chemicals.
7. Paints and solvents may be harmful or fatal if swallowed or inhaled. Avoid prolonged skin contact with solvents or paints as they will irritate skin. After any contact, immediately wash off exposed area with hot, soapy water.
8. Attach all accessories properly to the tool before connecting the air supply. A loose accessory may detach or break during operation.
9. Install an in-line shutoff valve to allow immediate control over the air supply in an emergency, even if a hose is ruptured.
10. Air hose fittings may get hot during use. Allow fittings to cool before disconnecting.

### NOTICE

Clean the spray gun **IMMEDIATELY** after use. Delayed or inadequate cleaning will permanently clog the spray gun.

### NOTICE

Clean the spray gun **IMMEDIATELY** after use. Delayed or inadequate cleaning will permanently clog the spray gun.

# SAFETY INSTRUCTIONS

## ⚠ WARNING ⚠

Some dust created by power sanding, sawing, grinding, drilling, and other construction activities, contains chemicals known [to the state of California to cause cancer, birth defects, or other reproductive harm.

Some examples of the chemicals are:

- Lead from lead-based paints
- Crystalline silica from bricks, cement, and other masonry products
- Arsenic and chromium from chemically treated lumber

Your risk from these exposures vary, depending on how often you do this type of work. To reduce your exposure to these chemicals: work in a well ventilated area, and work with approved safety equipment, such as those dust masks that are specifically designed to filter out microscopic particles. (California Health & Safety Code § 25249.5, *et seq.*)

The brass components of this product contain lead, a chemical known to the State of California to cause birth defects (or other reproductive harm). (California Health & Safety Code § 25249.5, *et seq.*)

## SPECIFICATIONS





Maximum Air Pressure	45 PSI	Cup Capacity	120 cc
Air Inlet	1/4" - 18 NPS	Air Consumption	3.2-5.6 CFM @ 40 PSI

<b>PSI</b>	Pounds per square inch of pressure
<b>CFM</b>	Cubic Feet per Minute flow
<b>SCFM</b>	Cubic Feet per Minute flow at standard conditions
<b>NPT</b>	National Pipe Thread, Tapered
<b>NPS</b>	National Pipe Thread, Straight

# TROUBLESHOOTING

## TROUBLESHOOTING - SPRAY PATTERN DIAGNOSIS

NOTE: The drawings on the left below resemble symptoms of spray pattern problems. Refer to the accompanying possible causes and likely solutions.

PROBLEM		POSSIBLE CAUSES	LIKELY SOLUTIONS
	Heavy Center Pattern	<ol style="list-style-type: none"> <li>1. Pattern knob partially closed.</li> <li>2. The paint is too thick.</li> <li>3. The pressure is too low.</li> </ol>	<ol style="list-style-type: none"> <li>1. Open pattern knob more.</li> <li>2. Thin paint according to the manufacturer's instructions.</li> <li>3. Increase air pressure within the operating air pressure.</li> </ol>
	Light Center Pattern	<ol style="list-style-type: none"> <li>1. High air pressure</li> <li>2. Fluid knob not open enough</li> <li>3. Pattern knob open too far</li> </ol>	<ol style="list-style-type: none"> <li>1. Reduce air pressure</li> <li>2. Open fluid knobs</li> <li>3. Partially close pattern knob</li> </ol>
	Heavy top/bottom pattern	<ol style="list-style-type: none"> <li>1. Nozzle plugged</li> <li>2. Nozzle loose or dirty seal</li> <li>3. Dried paint on fluid tip</li> <li>4. Damaged needle</li> </ol>	<ol style="list-style-type: none"> <li>1. Clean nozzle</li> <li>2. Clean and tighten nozzle seal</li> <li>3. Use a nonmetallic point to clean nozzle</li> <li>4. Have a qualified technician replace needle</li> </ol>
	Pattern on right or left only	<ol style="list-style-type: none"> <li>1. Dirt on one side of fluid tip</li> <li>2. Holes on one side of nozzle are plugged</li> <li>3. Damaged needle</li> </ol>	<ol style="list-style-type: none"> <li>1. Clean fluid tip</li> <li>2. Clean nozzle with nonmetallic point</li> <li>3. Have a qualified technician replace needle</li> </ol>

## NOTICE

Follow all safety precautions whenever diagnosing or servicing the tool.  
Disconnect the air supply before servicing.

## MAINTENANCE INSTRUCTIONS

5. Remove nozzle and soak it in solvent until it is clean. Use an old toothbrush and toothpicks to remove any residual paint.

### CAUTION

**Do not immerse the spray gun.**

**NOTE:** Do not use metal objects to clean the nozzle to prevent damage to the passages.

6. Inspect the fluid needle and make sure it is not bent. If it is bent, have it replaced by a qualified technician.

7. Use appropriate solvent (See Solvent Selection, Page 16) to wipe down the gun body.

8. Lubricate the spray gun after cleaning. A non-silicon oil or a light lubricant may be used on threaded connections before storing.

### SOLUTION DISPOSAL

After cleaning, dispose of the cleaning solution according to the solution manufacturer's directions and local hazardous waste standards.

### AIR SUPPLY MAINTENANCE

After each use, perform maintenance on the air supply according to the component manufacturer's instructions.

### STORAGE

Store in a dry, secure area out of reach of children.

### NOTICE

Clean the spray gun **IMMEDIATELY** after use. Delayed or inadequate cleaning will permanently clog the spray gun.

17

## INITIAL SET UP

### ⚠ WARNING ⚠

Read the **ENTIRE IMPORTANT SAFETY INFORMATION** section at the beginning of this manual including all text under subheadings therein before set up or use of this product.

### BEFORE SETUP

1. This air tool may be shipped with a protective plug covering the air inlet. Remove this plug before set up.
2. Before first use, clean the spray gun using a solvent-based thinner. If not removed, the material used for testing and corrosion prevention will contaminate the paint.

### ⚠ WARNING ⚠

To prevent serious injury from explosion, use only clean, dry, regulated, compressed air to power this tool. Do not use oxygen, carbon dioxide, combustible gases, or any other bottled gas as a power source for this tool.

### AIR SUPPLY SETUP

1. Incorporate a filter, regulator with pressure gauge, in-line shutoff valve, and quick coupler for best service, as shown on Figure A on page 8 and Figure B on page 9. An in-line shutoff ball valve is an important safety device because it controls the air supply even if the air hose is ruptured. The shutoff valve should be a ball valve because it can be closed quickly.

Note: Do not use an automatic oiler system or add oil to the airline. The oil will contaminate the material being propelled, ruining the final result.

2. Attach an air hose to the compressor's air outlet. Connect the air hose to the air inlet of the tool. Other components, such as a coupler plug and quick coupler, will make operation more efficient, but are not required.

### ⚠ WARNING ⚠

To prevent serious injury from accidental operation: Do not install a female quick coupler on the tool. Such a coupler contains an air valve that will allow the air tool to retain pressure and operate accidentally after the air supply is disconnected.

6

## SAFETY INSTRUCTIONS

**Note:** Air flow, and therefore tool performance, can be hindered by undersized air supply components.

3. The air hose must be long enough to reach the work area with enough extra length to allow free movement while working.
4. Close the in-line shutoff valve between the compressor and the tool.
5. Turn on the air compressor according to the manufacturer's directions and allow it to build up pressure until it cycles off.
6. Adjust the air compressor's output regulator so that the air output is enough to properly power the tool, but the output will not exceed the tool's maximum air pressure at any time. Adjust the pressure gradually, while checking the air output gauge to set the right pressure range.
7. Inspect the air connections for leaks. Repair any leaks found.
8. If the tool will not be used at this time, turn off and detach the air supply and safely discharge any residual air pressure to prevent accidental operation.

**Note:** Residual air pressure should not be present after the tool is disconnected from the air supply. However, it is a good safety measure to attempt to discharge the tool in a safe fashion after disconnecting to ensure that the tool is disconnected and unpowered.

### NOTICE

Clean the spray gun **IMMEDIATELY** after use. Delayed or inadequate cleaning will permanently clog the spray gun.

7

## CLEANING

### SOLVENT SELECTION

Follow the paint manufacturer's recommendations for cleaning, solvent type, and disposing of used solvent.

· **Latex Paints:** Do not use this spray gun with latex paint.

**IMPORTANT:** Do not use mineral spirits on latex paints or the mixture will congeal, making it very difficult to remove.

· **Oil Paints:** Use mineral spirits



**TO PREVENT FIRE, IF A FLAMMABLE SOLVENT NEEDS TO BE USED, ADHERE TO THE FOLLOWING:**

- a. Follow solvent manufacturer's clean up instructions and safety precautions.
- b. Flush spray gun a full hose length from the air compressor.
- c. If collecting flushed solvents in metal container, transfer to nonmetal container, and flush metal container.
- d. Work far away from any ignition sources in a vapor free area.
- e. Keep class ABC fire extinguisher nearby.

### AFTER EACH USE:

1. Empty the cup and clean it with the solvent.
2. Fill the cup with solvent and spray it through the spray gun into a container, while shaking the spray gun. Once the cup is empty, repeat the process until the solvent comes out clean.
3. Disconnect the spray gun from the air source.
4. After disconnecting, point the spray gun into the spent solvent container and squeeze the trigger again to ensure no air remains.

16



# MAINTENANCE INSTRUCTIONS



Procedures not specifically explained in this manual must be performed only by a qualified technician.

## WARNING

### TO PREVENT SERIOUS INJURY:

Detach the air supply and safely discharge any residual air pressure in the tool before performing any inspection, maintenance, or cleaning procedures.

### TO PREVENT SERIOUS INJURY FROM TOOL FAILURE:

Do not use damaged equipment. If abnormal noise, vibration, or leaking air occurs, have the problem corrected before further use.

## INSPECTION

Note: These procedures in addition to the regular checks and maintenance explained as part of the regular operation of the air-operated tool.

Before each use, inspect the general condition of the tool. Check for:

- Loose screws
- Misalignment or binding of moving parts
- Clogged nozzle
- Damaged air supply hose
- Cracked or broken parts
- Any other condition that may affect its safe operation

## NOTICE

Clean the spray gun **IMMEDIATELY** after use. Delayed or inadequate cleaning will permanently clog the spray gun.

FIGURE A: PORTABLE AIR SUPPLY SET UP

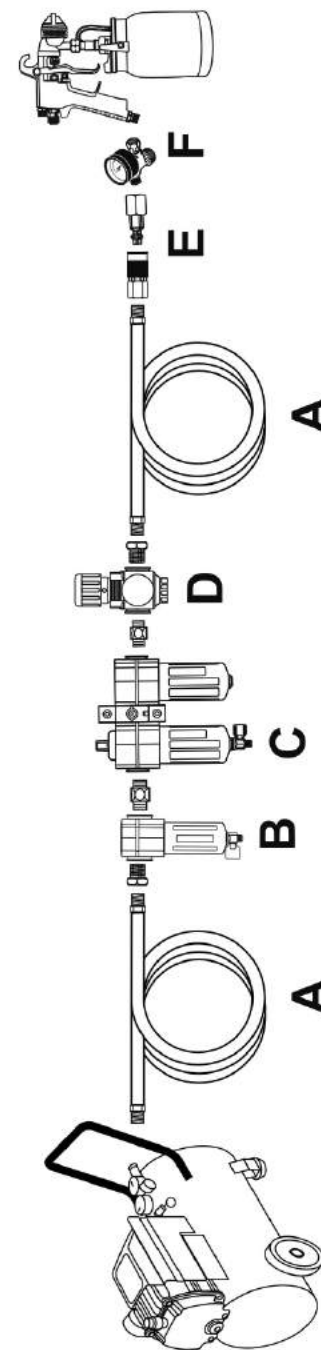

	DESCRIPTION	FUNCTION
A	Air Hose	Connects air to tool
B	Filter	Prevents dirt and condensation from damaging tool or workpiece
C	Air Cleaner/Dryer*	Prevents water vapor from damaging workpiece
D	Regulator	Adjusts air pressure to tool
E	Coupler and Plug	Provides quick connection and release
F	Air Adjusting Valve*	For fine tuning airflow at tool

\* Optional Components

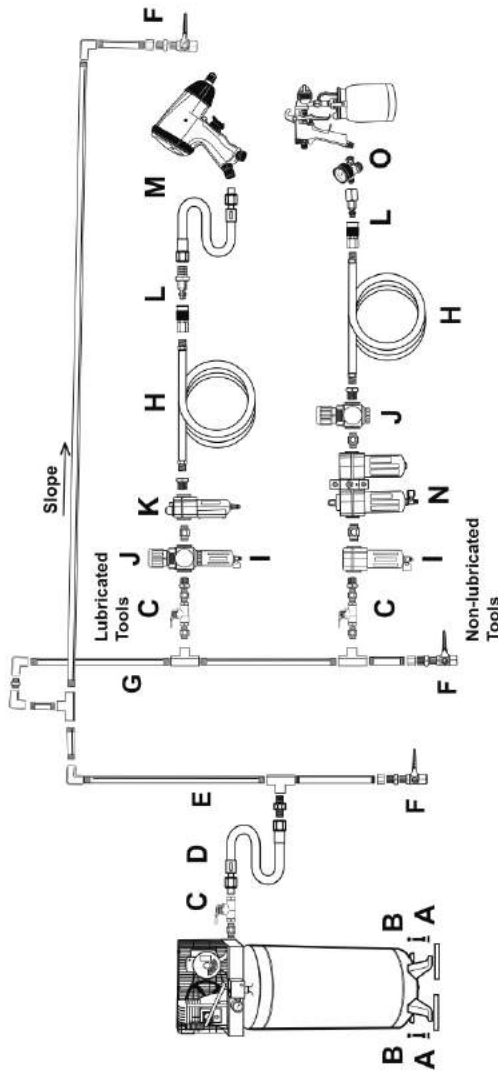

DESCRIPTION	FUNCTION
A	Vibration Pads For noise and vibration reduction
B	Anchor Bolts Secures air compressor in place
C	Ball Valve Isolates sections of system for maintenance
D	Isolation Hose For vibration reduction
E	Main Air Line (3/4" min.) Distributes air to branch lines

DESCRIPTION	FUNCTION
F	Ball Valve To drain moisture from system
G	Branch Air Line (1/2" min) Brings air to point of use
H	Air Hose Connects air to tool
I	Filter Prevents dirt and condensation contamination
J	Regulator Adjusts air pressure to tool

DESCRIPTION	FUNCTION
K	Lubricator* Provides quick connection and release
L	Coupler & Plug Increases coupler life
M	Leader Hose* Prevents moisture contamination
N	Air Cleaner/Dryer* For fine tuning airflow at tool
O	Air Adjusting Valve* Optional Components

FIGURE B: STATIONARY AIR SUPPLY SET UP

## OPERATING INSTRUCTIONS

3. Using two hands, one to steady the cup and the other to operate the spray gun, aim nozzle at the workpiece.

### CAUTION

**DO NOT STOP WHEN SPRAYING.**

Spraying materials will start to set and dry as soon as they come in contact with the air. They will cause a permanent clog if not cleared immediately. If discontinuing spraying for more than half an hour, turn off the air supply, disconnect cup from gun body and thoroughly rinse cup and gun body with fresh, clean water.

4. Pull trigger slowly and move the spray gun in parallel strokes to the workpiece. Keep the distance from the workpiece at about 6" to 9", depending on the flow adjustment and the paint.

5. To avoid paint build up, start moving the spray gun **before** squeezing the trigger. When finished with the stroke, release the trigger **while still moving** the spray gun - see Figure I.

Doing this will produce a smoother finish. Do not stop moving the spray gun while spraying. If the spray gun stops even briefly while spraying the paint will build up and run down the workpiece.

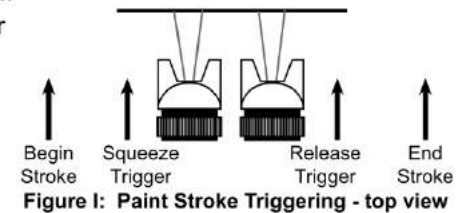

**Note:** The stroke speed, the fluid knob adjustment, and the distance from the workpiece, will determine how much paint is being applied. Apply two thin coats rather than one thick coat.

**CAUTION:** Air hose fittings may get hot. Allow fittings to cool before disconnecting, or wear gloves to prevent burns.

6. To prevent accidents, release trigger, detach air supply, safely discharge any residual air pressure, and again release trigger after use.

7. Clean the spray gun thoroughly immediately after EVERY use, according to instructions on the following pages.

## FLUID ADJUSTMENT

12. Turn the fluid knob clockwise until it is fully closed.

13. After setting up a piece of scrap material, squeeze the Trigger in short bursts while turning the Fluid Knob counterclockwise to set the amount of fluid - see Figure F: Fluid Adjustment.

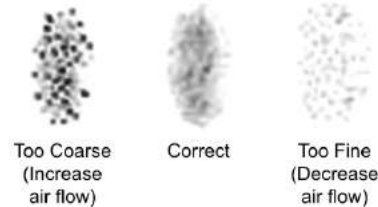

Figure F: Fluid Adjustment

**If spray is too fine:**

Reduce the air pressure or allow more paint to come out by opening the Fluid Knob.

**If spray is too thick (globs of paint):**

Close the Fluid Knob slowly, checking the pattern after each adjustment.

## SPRAYING TECHNIQUE

**IMPORTANT:** Proper spraying technique is ESSENTIAL to achieve good results.

1. First, prepare the spray gun according to the instructions under Spray Gun Set Up Adjustment.

2. Keep the spray gun upright and at a right angle to the workpiece - see Figure G and Figure H.

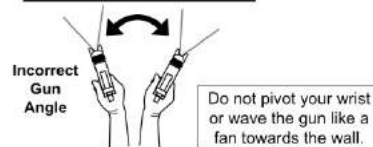
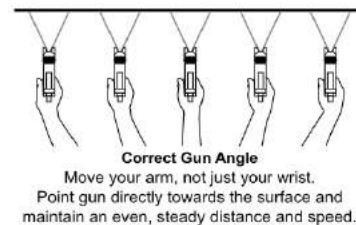

Figure G: Spray Gun Angle - Top View

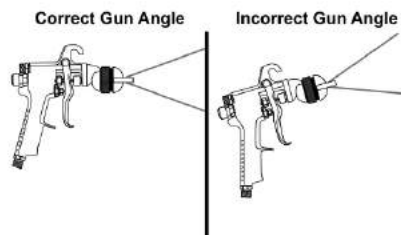

Figure H: Spray Gun Angle - Side View

## ⚠ WARNING ⚠

Read the **ENTIRE IMPORTANT SAFETY INFORMATION** section at the beginning of this manual including all text under subheadings therein before set up or use of this product.

Inspect the tool before use. If you see damaged, loose, or missing parts, **DO NOT** use the tool until it is repaired.

## WORKPIECE AND WORK AREA SET UP

1. This air tool may be shipped with a protective plug covering the air inlet. Remove this plug before set up.

2. Before first use, clean the spray gun using a solvent-based thinner. If not removed, the material used for testing and corrosion prevention will contaminate the paint.

3. Before spraying, mask nearby objects not being sprayed and lay cloths (not included) on the floors.

## SPRAY GUN SET UP ADJUSTMENTS

**CAUTION!** Keep hands away from trigger while making adjustments.

1. Thread the Cup to the top of the gun body and tighten until the cup is securely in place.

2. Thread the Air Regulator (44) into the Air Connector (43).

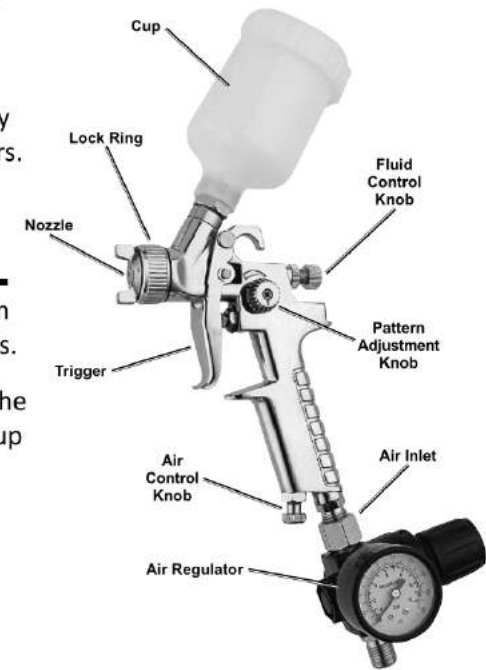

Figure C: Components & Controls

# OPERATING INSTRUCTIONS

## ⚠ WARNING ⚠

To prevent serious injury: Do not adjust or tamper with any control or component in a way not specifically explained within this manual. Improper adjustment can result in tool failure or other serious hazards.

**Note:** This spray gun is meant for spraying oil-based paints. It is NOT recommended for regular wall paint or thin coatings of any type. While these products can be used with this spray gun, coverage may not be even.

### PAINT PREPARATION AND FILLING

Note: Proper paint mixture is essential. Follow the manufacturer's directions. Most paints will spray easily if they are thinned properly.

3. Thin the paint according to manufacturer's directions and mix thoroughly.
4. Carefully strain the paint through a paint strainer or a piece of cheesecloth.
5. Fill the Cup to 3/4 full. Close Cup.
6. Start the air compressor and set the regulator to needed pressure.

**Do not exceed maximum air pressure!**

7. Test the consistency by spraying on a piece of scrap material.

If it still appears too thick, add a very small amount of thinner (not included) and mix thoroughly. Use the proper thinner for the type of paint. *Thin CAUTIOUSLY.* Proceed slowly, adding minimal amounts at a time.

**DO NOT exceed the manufacturer's thinning recommendations.**

### NOTICE

Clean the spray gun **IMMEDIATELY** after use. Delayed or inadequate cleaning will permanently clog the spray gun.

# OPERATING INSTRUCTIONS

## FAN DIRECTION

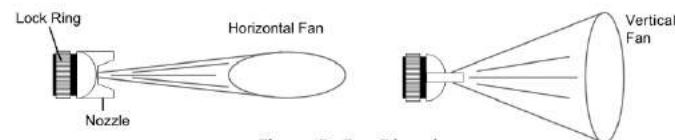

Figure D: Fan Direction

8. To change the direction of the fan from horizontal to vertical, loosen the Lock Ring and turn the nozzle 90°.
9. After the adjustment, tighten the Lock Ring by hand.

## PATTERN ADJUSTMENT

### ⚠ WARNING ⚠

Do not exceed the Maximum Air Pressure shown on the specification chart.

10. Adjust the air supply pressure during operation with the Trigger fully depressed and the air knob fully open. If reducing air pressure for specific areas, use the air knob.
11. Use the pattern knob to adjust the spray pattern. Turn the pattern knob counterclockwise (all the way open) to flatten the spray pattern. Turn it clockwise for a round spray pattern - see Figure E: Pattern Adjustment.

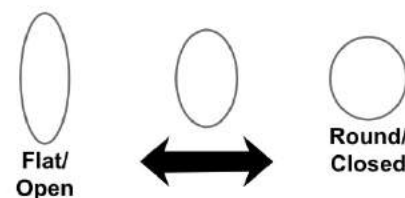

Figure E: Pattern Adjustment

### NOTICE

Clean the spray gun **IMMEDIATELY** after use. Delayed or inadequate cleaning will permanently clog the spray gun.