

OREGON®



**Original Instruction Manual
Chainsaw Model CS1500-093**



⚠ WARNING: Read and understand all safety warnings and all instructions. Failure to follow the warnings and instructions may result in electric shock, fire and/or serious injury. Save all warnings and instructions for future reference.

Table of Contents



Important Safety Instructions	5
Introduction	5
Safety Signal Definitions	5
General Power Tool Safety Warnings	5
Work Area Safety	5
Electrical Safety	5
Personal Safety	6
Power Tool Use and Care	6
Service	7
Chainsaw Safety Warnings	7
Causes and Operator Prevention of Kickback	8
Kickback Safety Devices on this Saw	9
Storage, Transporting, and Disposal	9
Symbols and Labels	10
Chainsaw Names and Terms	11
Product Identification	12
Preparing for Use	13
Checking the Front Hand Guard Position	13
Filling the Bar and Chain Oil Reservoir	14
Tensioning the Saw Chain	15
Operating the Chainsaw	16
General Operation	16
6 Meter Power Cord Use and Care	18
Cutting	18
Sharpening with PowerSharp®	23
Maintenance and Cleaning	24
Inspection	24
Cleaning	24
Maintaining the Guide Bar	25
Replacing a Worn Saw Chain and Sharpening Stone	26
Replacing a Worn Guide Bar	27
Replacing a Worn Chain Tensioning Gear	27
Replacing the Drive Sprocket	28
Tensioning the Saw Chain	28
Additional Maintenance Information	28
Troubleshooting	29
Specifications and Components	31
Warranty and Service	32
EC – Declaration of Conformity	33
Customer Service	34

Important Safety Instructions

Introduction

This chainsaw is designed for occasional light-duty use. It is not designed to fell large trees or cut large diameter logs. This chainsaw is not designed for tree service. Do not cut trees or wooden timbers that have a diameter greater than the effective cutting length of the chain saw, 17 inches (43 cm).

Safety Signal Definitions

SYMBOL	SIGNAL	MEANING
	WARNING	Indicates a potential hazard which could result in serious injury.
	CAUTION	Indicates a potential hazard which could seriously damage the tool or cause minor to moderate injury.
	IMPORTANT	Following this instruction will increase satisfaction with the tool.

General Power Tool Safety Warnings

⚠ WARNING: Read and understand all safety warnings and all instructions. Failure to follow the warnings and instructions may result in electric shock, fire and / or serious injury.



⚠ Save all warnings and instructions for future reference. The term “power tool” in the warnings refers to your mains-operated (corded) power tool or battery operated (cordless) power tool.

Work Area Safety

- **Keep work area clean and well lit.** Cluttered or dark areas invite accidents.
- **Do not operate power tools in explosive atmospheres, such as in the presence of flammable liquids, gases or dust.** Power tools create sparks which may ignite the dust or fumes.
- **Keep children and bystanders away while operating a power tool.** Distractions can cause you to lose control.

Electrical Safety

- **Power tool plugs must match the outlet. Never modify the plug in any way. Do not use any adapter plugs with earthed (grounded) power tools.** There is an increased risk of electric shock if your body is earthed or grounded.
- **Avoid body contact with earthed or grounded surfaces, such as pipes, radiators, ranges and refrigerators.** Water entering the charger will increase the risk of electric shock.
- **Do not expose power tools to rain or wet conditions.** Water entering a power tool will increase the risk of electric shock.
- **Do not abuse the 6 meter cord. Never use the 6 meter cord for carrying, pulling or unplugging the power tool. Keep 6 meter cord away from heat, oil, sharp edges or moving parts.** Damaged or entangled cords increase the risk of electric shock.
- **When operating a power tool outdoors, use an extension cord suitable for outdoor use.** Use of a cord suitable for outdoor use reduces the risk of electric shock.
- **If operating a power tool in a damp location is unavoidable, use a ground fault circuit interrupter (GFCI) protected supply.** Use of a GFCI reduces the risk of electric shock.

Personal Safety

- **Stay alert, watch what you are doing and use common sense when operating a power tool. Do not use a power tool while you are tired or under the influence of drugs, alcohol or medication.** A moment of inattention while operating power tools may result in serious personal injury.
- **Use personal protective equipment. Always wear eye protection.** Protective equipment such as dust mask, non-skid safety shoes, hard hat or hearing protection used for appropriate conditions will reduce personal injuries.
- **Prevent unintentional starting. Ensure the switch is in the off-position before connecting to power source and/or battery pack, picking up or carrying the tool.** Carrying power tools with your finger on the switch or energising power tools that have the switch on invites accidents.
- **Remove any adjusting key or wrench before turning the power tool on.** A wrench or a key left attached to a rotating part of the power tool may result in personal injury.
- **Do not overreach. Keep proper footing and balance at all times (Fig. 1).** This enables better control of the power tool in unexpected situations.

FIG. 1

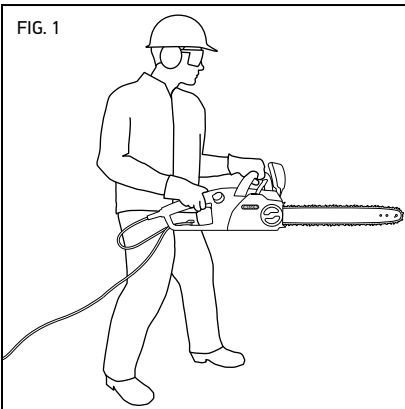

- **Dress properly. Do not wear loose clothing or jewellery. Keep your hair, clothing and gloves away from moving parts.** Loose clothes, jewellery or long hair can be caught in moving parts.

- **If devices are provided for the connection of dust extraction and collection facilities, ensure these are connected and properly used.** Use of dust collection can reduce dust-related hazards.

Power Tool Use and Care

- **Do not force the power tool. Use the correct power tool for your application.** The correct power tool will do the job better and safer at the rate for which it was designed.
- **Do not use the power tool if the switch does not turn it on and off.** Any power tool that cannot be controlled with the switch is dangerous and must be repaired.
- **Disconnect the plug from the power source and/or the battery pack from the power tool before making any adjustments, changing accessories or storing power tools.** Such preventive safety measures reduce the risk of starting the power tool accidentally.
- **Store idle power tools out of the reach of children and do not allow persons unfamiliar with the power tool or these instructions to operate the power tool.** Power tools are dangerous in the hands of untrained users.
- **Maintain power tools. Check for misalignment or binding of moving parts, breakage of parts and any other condition that may affect the power tool's operation. If damaged, have the power tool repaired before use.** Many accidents are caused by poorly maintained power tools.
- **Keep cutting tools sharp and clean.** Properly maintained cutting tools with sharp cutting edges are less likely to bind and are easier to control.
- **Use the power tool, accessories and tool bits, etc. in accordance with these instructions taking into account the working conditions and the work to be performed.** Use of the power tool for operations different from those intended could result in a hazardous situation.

Service

Have your power tool serviced by a qualified repair person using only identical replacement parts. This will ensure that the safety of the power tool is maintained.

Chainsaw Safety Warnings

- **Keep all parts of the body away from the saw chain when the chainsaw is operating. Before you start the chainsaw, make sure the saw chain is not contacting anything.** A moment of inattention while operating chainsaws may cause entanglement of your clothing or body with the saw chain.
- **Always hold the chainsaw with your right hand on the rear handle and your left hand on the front handle (Fig. 2).** Holding the chainsaw with a reversed hand configuration increases the risk of personal injury and should never be done.

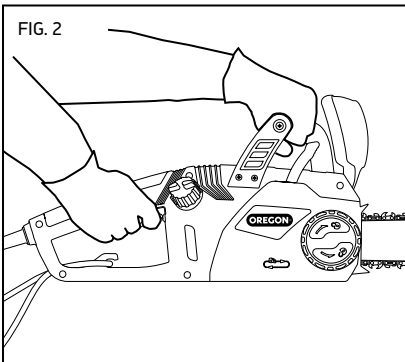

- **Hold the power tool by insulated gripping surfaces only, because saw chain may contact hidden wiring or its own 6 meter cord.** Saw chains contacting a "live" wire may make exposed metal parts of the power tool "live" and could give the operator an electric shock.
- **Wear safety glasses and hearing protection. Further protective equipment for head, hands, legs and feet is recommended.** Adequate protective clothing will reduce personal injury by flying debris or accidental contact with the saw chain.

- **Do not operate a chainsaw in a tree.** Operation of a chainsaw while up in a tree may result in personal injury.
- **Always keep proper footing and operate the chainsaw only when standing on a fixed, secure and level surface.** Slippery or unstable surfaces may cause a loss of balance or control of the chainsaw.
- **When cutting a limb that is under tension, be alert for spring back.** When the tension in the wood fibres is released, the spring loaded limb may strike the operator and/or throw the chainsaw out of control.
- **Use extreme caution when cutting brush and saplings.** The slender material may catch the saw chain and be whipped toward you or pull you off balance.
- **Carry the chainsaw by the front handle with the chainsaw switched off and away from your body. When transporting or storing the chainsaw, always fit the guide bar cover (Fig. 3).** Proper handling of the chainsaw will reduce the likelihood of accidental contact with the moving saw chain.

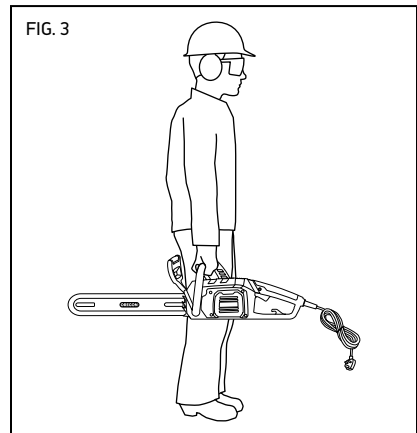

- **Follow instructions for lubricating, chain tensioning and changing accessories.** Improperly tensioned or lubricated chain may either break or increase the chance of kickback.
- **Keep handles dry, clean and free of oil and grease.** Greasy, oily handles are slippery causing loss of control.

- **Cut wood only. Do not use the chainsaw for purposes not intended.** For example: do not use chainsaw for cutting plastic, masonry or non-wood building materials. Use of the chainsaw for operations different than intended could result in a hazardous situation.
- **It is recommended that the first time user should have practical instruction in the use of the chainsaw and the recommended protective equipment from an experienced operator.** The initial practice should be cutting logs on a saw-horse or cradle.
- **Other than the wear parts identified in this manual, the chainsaw has no user serviceable parts.**
- **The work piece, bar and chain can be hot after cutting. Wear gloves to avoid burns.**
- **Prolonged use of power tools has been reported to cause vascular, muscular and/or neurological disorders (such as vibration white finger or Raynaud's syndrome), particularly when operating the tool in cold weather. If you experience numbness or loss of feeling in your extremities, stop using the tool until symptoms fade.** To reduce the incidence of vibration induced trauma, follow these instructions:
 - Wear gloves and keep hands and body warm.
 - Maintain a firm grip on the chainsaw, but do not use prolonged, excessive pressure. Let the chainsaw do the work.
 - Assure that the cutting system is maintained properly.
 - Take frequent breaks.

The vibration in normal use can differ from the stated values in this manual, depending on the material being cut, maintenance of the cutting system and other factors.

- **Keep the 6 meter cord behind you, and know the position of the 6 meter cord at all times.** Keeping the 6 meter cord behind you and knowing the position of the 6 meter cord will help minimize tripping hazards and prevent severing of the 6 meter cord with the chainsaw.

- **If the 6 meter cord is cut or damaged, immediately stop using the chainsaw and disconnect the 6 meter cord from the mains.** A damaged or cut 6 meter cord increases the risk of electrical shock.
- **When used in a wet environment, use a GFCI with a tripping current of less than 30mA.** Use of a GFCI reduces the risk of electric shock.

Causes and Operator Prevention of Kickback



Kickback may occur when the nose or tip of the guide bar touches an object, or when the wood closes in and pinches the saw chain in the cut.

Tip contact, in some cases, may cause a sudden reverse reaction, kicking the guide bar up and back towards the operator.

Pinching the saw chain along the top of the guide bar may push the guide bar rapidly back towards the operator.

Either of these reactions may cause you to lose control of the saw which could result in serious personal injury. Do not rely exclusively on the safety devices built into your saw. As a chainsaw user, you should take several steps to keep your cutting jobs free from accident and injury.

Kickback is the result of tool misuse and/or incorrect operating procedures or conditions and can be avoided by taking proper precautions as given below:

- Maintain a firm grip with thumbs and fingers encircling the chainsaw handles, with both hands on the saw and position your body and arm to allow you to resist kickback forces. Kickback forces can be controlled by the operator, if proper precautions are taken. Do not let go of the chainsaw.
- Do not overreach and do not cut above shoulder height. This helps prevent unintended tip contact and enables better control of the chainsaw in unexpected situations.

- Follow the Oregon sharpening and maintenance instructions for the saw chain. Decreasing the depth gauge height can lead to increased kickback.

Kickback Safety Devices on this Saw

⚠ DANGER: Never modify or attempt to disable the chain brake.

⚠ DANGER: Only use replacement bars and chains specified by Oregon. Incorrect replacement bars and chains may cause chain breakage and increased risk of kickback injury.

CHAIN BRAKE

This chainsaw comes equipped with a chain brake, which stops both the motor and the motion of the chain when kickback occurs (Fig. 4). The chain brake can be activated by the forward motion of the front hand guard as the saw rotates backward during kickback; it can also be activated by the inertial forces generated from a kickback event.

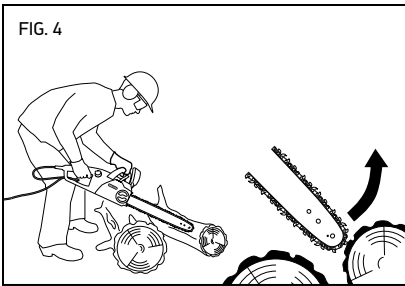

CHAIN

This chainsaw comes equipped with a saw chain that met the reduced kickback performance requirements of the American National Standards Institute (ANSI) and Canadian Standards Association (CSA), ANSI B175.1 and CSA Z62.3 respectively, when tested according to the provisions of the standards. For replacement chain, see “Specifications and Components” in this manual.

BAR

This saw comes equipped with a reduced kickback guide bar that has a small radius nose.

Smaller radius noses have less potential for kickback than a bar of the same size with a larger nose radius.

When replacing the bar, only order the bar listed in this manual to maintain low kickback performance.

Storage, Transporting, and Disposal



STORING THE CHAINSAW

- Unplug the chainsaw.
- Inspect the 6 meter cord for cuts or damage.
- Clean chainsaw thoroughly.
- Install the guide bar cover.
- Store in a dry place.
- Keep out of reach of children or pets.
- It is normal for a small amount of oil to seep from the guide bar when the chainsaw is not in use. To protect against seepage, install the guide bar cover and place an absorbent pad under the bar.

TRANSPORTING THE CHAINSAW

Tools can shift during transport. Ensure the tool is secure and cannot fall or move into contact with people or property.

- Unplug the chainsaw.
- Install the guide bar
- If desired, drain the bar and chain oil to reduce seepage.

CHAINSAW DISPOSAL

This Oregon product is designed and manufactured with high quality materials and components which can be recycled and reused. Upon product end-of-life, and according to Directive 2002/95/EC, the electrical appliance should be disposed of separately from household waste. In the European Union, there are separate collection systems for used electrical and electronic products. Please dispose of this equipment in an environmentally correct manner at a local community waste collection/recycling centre.

Symbols and Labels

These symbols and labels appear on the chainsaw and/or in this manual.

SYMBOL	NAME	EXPLANATION
	Class II construction	Designated double insulated construction tools.
	Safety alert symbol	Indicates that the text that follows explains a danger, warning or caution.
	Read instructions	The original instruction manual contains important safety and operating information. Read and follow the instructions carefully.
	Wear eye protection	Wear eye protection when operating the chainsaw.
	Wear hearing protection	Wear hearing protection when operating the chainsaw.
	Wear hand protection	Wear gloves when operating the chainsaw and when handling the saw chain.
	Wear head protection	Wear head protection when operating the chainsaw.
	Wear long pants	Wear long pants when operating the chainsaw.
	Wear foot protection	Wear appropriate closed-toe work boots when operating the chainsaw.
	Sound power, Lwa	Sound power level.
	Beware of kickback	⚠ Danger: Kickback can cause severe injuries.
	Bar nose contact	Avoid bar nose contact.
	Chainsaw kickback angle	Designed for use with low kickback saw chain.
	Two-handed hold	Hold saw with both hands.
	One-handed hold	Do not hold the saw with one hand.
	Do not use a ladder	Never stand on a ladder when using the chainsaw.
	Do not dispose	Do not throw in household waste. Take to an authorised recycler.
	Do not expose to rain	Do not operate the chainsaw in wet conditions.
	Damaged cable	Inspect the 6 meter power cord regularly for damage. Remove the plug from the mains immediately if the cable is damaged or cut.
	Cutting tool	Cutting tool. Do not touch the chain without first deactivating the chainsaw by unplugging it.
	Trip hazard	Know the location of the 6 meter cord at all times.
	Unplug before maintenance	Unplug before performing any maintenance.

Chainsaw Names and Terms

Alignment flange: The protrusion on the bar pad that fits into the bar slot.

Automatic oiler: The system that automatically lubricates the guide bar and saw chain.

Bar pad: The mounting pad on the powerhead that helps ensure proper alignment of the guide bar.

Bar slot: The cut-out portion of the guide bar that fits on to the alignment flange and mounting stud.

Bystander safety zone: A 6 m (20 ft.) circle around the operator that must remain free from bystanders, children and pets.

Chain brake: A device for stopping or locking the saw chain, activated manually or non-manually when kickback occurs.

Chain catcher: A device for retaining the saw chain if it breaks or derails.

Chain gauge: The thickness of the saw chain drive link, where it fits into the bar groove, indicated by the part number stamped on the drive links.

Chain pitch: The distance between any three consecutive rivets on the saw chain divided by two, indicated by the part number stamped on the drive links.

Chainsaw powerhead: A chainsaw without the saw chain or guide bar.

Chain tensioning gear: A gear mounted on the guide bar that adjusts saw chain tension when rotated.

Chain tensioning ring: The ring around the side cover release knob that when turned, adjusts the saw chain tension.

Drive link: The fin-shaped link of the saw chain that fits into the groove on the guide bar.

Drive sprocket: The toothed part that drives the saw chain.

Effective cutting length: The approximate distance from the root of the spiked bumper to the outside edge of the cutting link with the tensioner set to the middle position.

Felling back cut: The final cut in a tree felling operation made on the opposite side of the tree from the notching undercut.

Front handle: The support handle located at or toward the front of the chainsaw intended to be gripped by the left hand.

Front hand guard: A structural barrier between the front handle of a chainsaw and the guide bar, which also serves as an activating mechanism for the chain brake.

Guide bar: A railed structure that supports and guides the saw chain. Sometimes simply called the "bar".

Guide bar cover: The plastic cover that protects the guide bar and saw chain when the chainsaw is not in use.

Kickback: The rapid backward and/or upward motion of the guide bar, occurring when the saw chain near the top area of the nose of the guide bar contacts any object (such as a log or branch), or when the wood closes in and pinches the saw chain in the cut.

Low-kickback chain: A chain that complies with the low kickback performance requirements of ANSI B175.1 and CSA Z62.3.

Motor housing: The plastic cover of the chainsaw powerhead.

Mounting stud: The threaded protrusion on the alignment flange that extends through the bar slot.

Notching undercut: A notch cut in a tree to direct the tree's fall.

Rear handle: The support handle located at or toward the rear of the saw intended to be gripped by the right hand.

Rear hand guard: A structural barrier at the bottom right side of the rear handle to protect the operator in case of rupture or derailing of the saw chain.

Reduced kickback guide bar: A guide bar with a maximum nose radius as specified in ANSI B175.1 and CSA Z62.3 and which has been demonstrated to reduce kickback significantly.

Saw chain: A loop of chain having cutting teeth, that cuts the wood, that is driven by the powerhead and is supported by the guide bar. Sometimes simply called the "chain".

Side cover: The plastic cover on the powerhead that covers the drive sprocket and chain tensioning gear which is removed and installed with the side cover release knob.

Spiked bumper: A device fitted to the front of the saw acting as a pivot point when in contact with a tree or log to make cutting easier. Also known as "bucking spikes".

Strain relief bracket: The 6 meter cord can be looped to the hook on the rear handle to keep it out of the way and assist in ease of operation.

Trigger lock-out: A movable stop that prevents the unintentional operation of the trigger switch until manually actuated.

Trigger switch: A device that turns the chainsaw on and off.

Wear parts: Parts such as the saw chain and guide bar that can wear during use and can be replaced by the user.

Product Identification

Know the Chainsaw

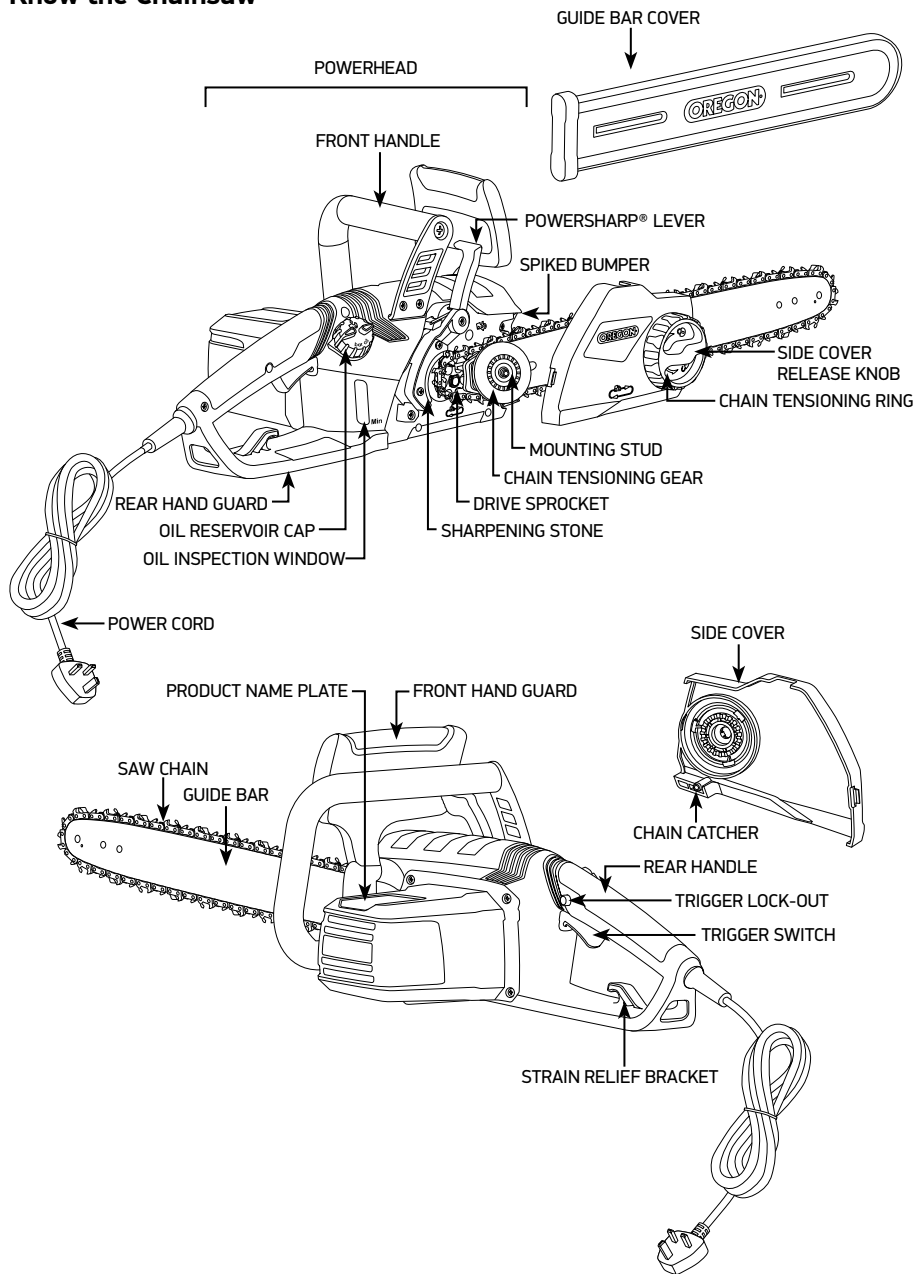

NOTE: See “Preparing for Use” for a list of included items.

Preparing for Use

⚠ DANGER: To avoid serious personal injury, do not operate the chainsaw without the guide bar, saw chain and side cover properly assembled.

⚠ WARNING: Do not attempt to operate the chainsaw if any part is damaged or missing.

⚠ WARNING: An electric power tool that is plugged in can start accidentally. Unplug the chainsaw before preparing for use or performing maintenance.

What's in the box?

These items ship with the chainsaw:

- Chainsaw powerhead with saw chain and guide bar attached
- Guide bar cover
- Bar and chain oil

After removing the chainsaw from the box, inspect it carefully to ensure no damage has occurred during shipping, and that no parts are missing. If any parts are damaged or missing, do not use the chainsaw. Contact Oregon® to obtain replacement parts.

Checking the Front Hand Guard Position

After unpacking the chainsaw, check the position of the front hand guard. The chainsaw will not run with the chain brake engaged. Pull the front hand guard back towards the front handle before operation (Fig. 5).

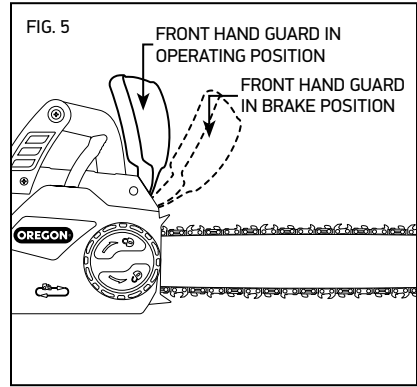

Filling the Bar and Chain Oil Reservoir

IMPORTANT: Bar and chain oil prevents premature wear. Never operate the chainsaw if oil is not visible in the inspection window. Check oil level frequently and fill as needed.

Bar and chain oil is required to properly lubricate the guide bar and saw chain. The chainsaw is equipped with an automatic oiler that deposits oil on the bar and chain when running, keeping them properly lubricated. Use Oregon bar and chain oil for best results. It is specially designed to provide low friction and faster cuts. **NEVER** use oil or other lubricants not specifically designed for use on the bar and chain. This can lead to a clogged oil system which may cause premature wear of the bar and chain.

Place the chainsaw on a firm, flat surface so that the oil cap is on top (Fig. 6).

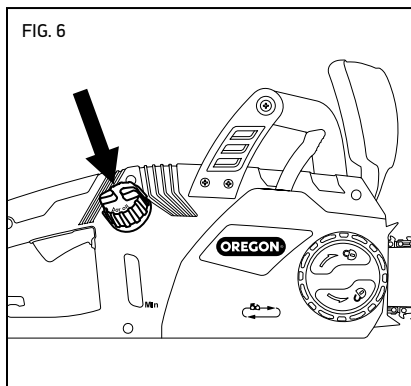

- Clean any debris from the cap area.
- Remove the cap.
- Carefully pour the bar and chain oil into the reservoir.
- Replace the cap and make sure oil is visible in the reservoir.

PRIMING THE OILER

⚠ WARNING: To reduce the risk of injury, never run the chainsaw without the side cover.

⚠ CAUTION: Keep hands, clothing, and hair away from the drive sprocket when priming the oiler.

If this is the first time filling the bar and chain oil reservoir, or if the chainsaw has been stored for a long period of time without use, prime the oiler.

Wear Gloves

- Unplug the chainsaw.
- Loosen the side cover release knob slightly, but do not remove the side cover.
- Loosen the chain tensioning ring (turn it counter clockwise) as far as it will go.
- Loosen the side cover release knob and remove the side cover.
- Remove the guide bar and saw chain.
- Plug in the chainsaw.
- Install the side cover, then lightly tighten the side cover release knob.
- Run the chainsaw for about two minutes.
- Unplug the chainsaw, remove the side cover and check for oil on the bar pad (Fig 7).

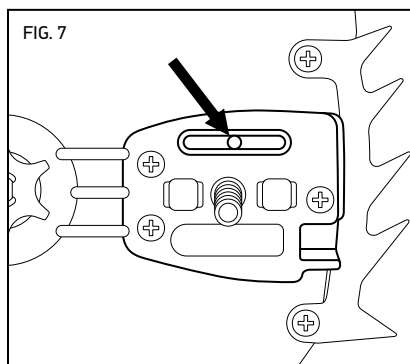

- If no oil is present on the bar pad, replace the side cover and run for another 30 seconds.

- When oil begins to seep from the hole, unplug the chainsaw and replace the bar and chain as described in “Maintaining the Guide Bar”.

If oil is not visible in the reservoir, additional bar and chain oil is necessary.

Tensioning the Saw Chain



⚠ WARNING: An electric power tool that is plugged in can start accidentally. Unplug the chainsaw before preparing for use or performing maintenance.

⚠ WARNING: If the chain is still loose when the saw is at maximum tension, replace the chain.

IMPORTANT: Only tension the saw chain when the chain is cool. A hot chain may contract and damage the guide bar or chain as it cools.

Wear Gloves

- Unplug the chainsaw before tensioning.
- Loosen the side cover release knob slightly, but do not remove the side cover.
- Hold up the nose of the guide bar (Fig. 8) and turn the chain tensioning ring clockwise.

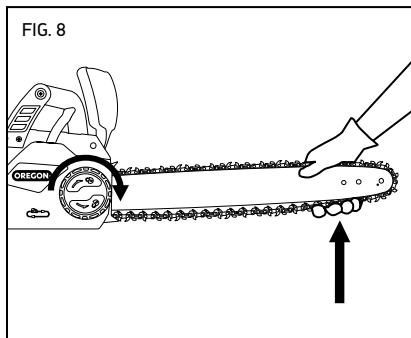

- Tighten the chain tensioning ring until the lowest cutters underneath the bar solidly contact the bar (Fig. 9).

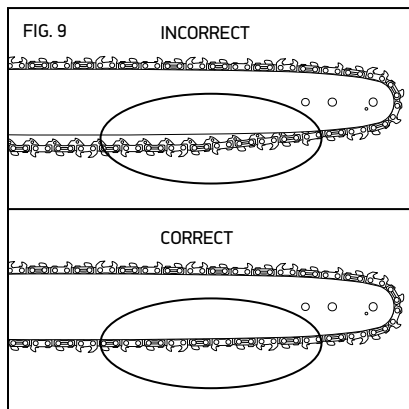

- Saw chain tension is correct when, with some effort, a gloved hand can pull the chain smoothly around the bar. The chain should touch the underside of the bar rail (Fig. 10).

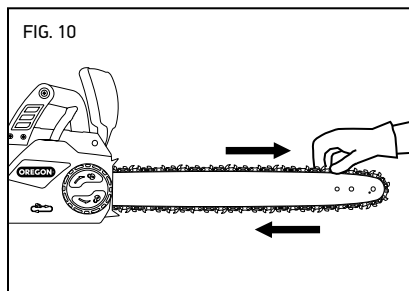

- Tighten the side cover release knob.
- After a short period of use, allow the chain to cool, unplug the chainsaw and check the tension again. Watch tension carefully for the first half-hour of use and periodically throughout the life of the chain readjusting as required when the chain and bar are cool to the touch. Never tension chain when it is hot.

Chain will stretch as a result of normal use, however, insufficient oil, aggressive use or failure to perform recommended maintenance can lead to premature stretching.

Operating the Chainsaw



General Operation

⚠ DANGER: To avoid serious personal injury, do not overreach and do not stand on a ladder, stepstool or any raised position that is not fully secured. Never cut above shoulder height.

⚠ WARNING: To reduce the risk of injury, always wear proper boots, gloves, head, ear and eye protection.

GRIP

Always grip the tool with both hands. Grasp the front handle with the left hand and the rear handle with the right (Fig. 11). Wrap the fingers over the top of the handle with the thumb below the handle.

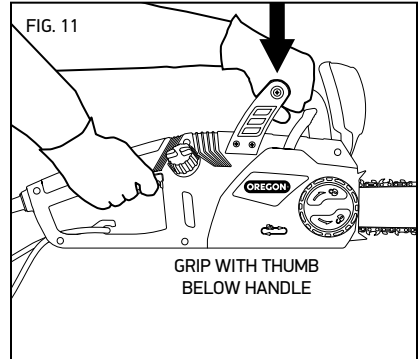

FOOTING

Stand with both feet on solid ground with weight evenly spread between them (Fig. 12).

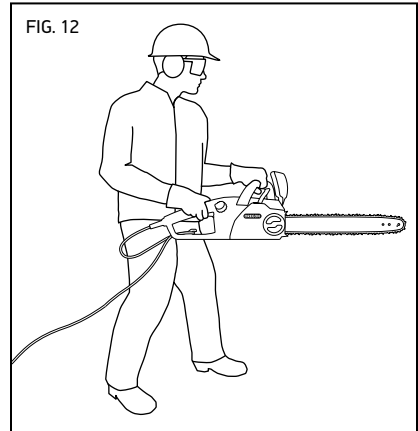

STOPPING THE CHAINSAW

Release the trigger switch to stop the chainsaw.

STARTING THE CHAINSAW

⚠ WARNING: To reduce the risk of injury, never defeat the interlock by taping, wiring or tying down the trigger lock-out.

Make sure the chain brake is not engaged.

Grasp the front and rear handles firmly. Press and hold the trigger lock-out with the thumb (1). To start the saw, squeeze the trigger switch (2) (Fig. 13). There is no need to continue to press the trigger lock-out. It will remain disengaged until the trigger is released.

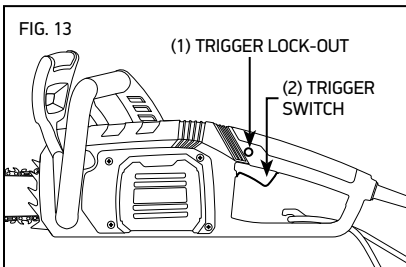

TESTING THE CHAIN BRAKE

Make sure the chain brake is working before using the chainsaw. To check brake operation:

- Place the saw on a firm, flat surface.
- Start the saw briefly.
- Keep the left hand on the front handle and roll the left wrist to move the front hand guard forward to manually activate the chain brake (Fig. 14).

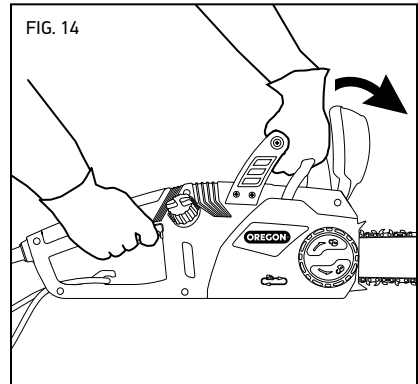

- Release the trigger switch.

A properly functioning chain brake stops the motor and saw chain immediately. If the motor and saw chain do not stop immediately, have the chain brake checked at an approved service location.

- Return the front hand guard to operating position.

6 Meter Power Cord Use and Care

The CS1500 comes with an attached 6 meter power cord. Prior to every use, make sure the cord insulation is free of cracks and the plug is undamaged.

Only use extension cords as approved for safe use in your region and for this application. If use of an extension cord is acceptable in your region, please use the selection criteria shown below in "Selecting an Extension Cord."

SELECTING AN EXTENSION CORD

Select an extension cord that is:

- Specifically labelled for outdoor use
- Of a wire size (AWG) heavy enough to carry the current the full length of the cable according to the table below

Select the gauge of extension cord based on the desired length and the electrical specifications found on the product label.

These are the recommended gauges based on the length of cord.

CORD LENGTH (M)	MINIMUM WIRE SIZE
0–15	14 AWG (1.5 mm ²)
16–30	12 AWG (3.0 mm ²)

Make sure the insulation is free of cracks and that the plugs on both ends are undamaged.

USING THE STRAIN RELIEF BRACKET

It is important to use the strain relief bracket as it saves wear on the power cord.

To use the strain relief bracket, bend the 6 meter cord into a U-shape and put it through the hole in the rear handle. Slide the loop of cord over the hook and tug lightly until snug (Fig. 15).

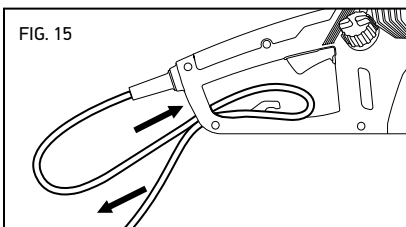

FIG. 15

Cutting

⚠ WARNING: To reduce the risk of injury, wear proper boots, gloves, head, ear and eye protection.

⚠ WARNING: To reduce the risk of electric shock, make sure the 6 meter cord insulation is intact and that the 6 meter cord is in a dry location where there is no danger of it being cut or tripped over.

⚠ WARNING: To reduce the risk of injury, always be sure of footing and hold the chainsaw firmly with both hands while the motor is running.

⚠ WARNING: To reduce the risk of injury, plan ahead and plan multiple escape paths before beginning work.

⚠ CAUTION: Establish a bystander safety zone of 6 m (20 ft) prior to operation of this equipment. Bystander safety zone is a minimum 6 m (20 ft) circle around the operator that must remain free from bystanders, children and pets (Fig. 16). Felling operations require a larger safety zone according to the size of the tree, see "Felling a Tree" section.

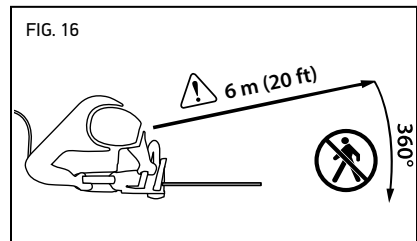

FIG. 16

IMPORTANT: Practice cutting logs on a sawhorse or cradle until you become comfortable operating the saw.

To get the best performance and operate the saw safely, follow these instructions:

- Observe all applicable national and municipal rules and regulations for cutting.
- Take frequent breaks to reduce the risk of injury.
- Before beginning to cut, make sure the saw chain is properly tensioned and the chain is sharp.

Saw chains are made to cut wood only. Do not use the chainsaw to cut any other materials, and do not allow the chain to come into contact with dirt, stones, nails, staples or wire. These materials are extremely abrasive and will wear away protective plating from the chain in a very short time.

Sharpen or replace the saw chain if any of these conditions occur:

- The pressure required to make cuts increases noticeably.
- Wood chips coming off of the chain are very fine or dust-like.

Do not work with a dull chain as it will increase the effort required to cut, cause jagged cuts, increase wear on the chainsaw and increase the risk of kickback. Never force a dull chain to cut.

- Assume the proper cutting grip and stance in front of the wood with the saw turned off. Press the trigger lock-out and squeeze the trigger switch. Let the chain reach full speed before beginning the cut.
- Begin cutting by lightly pressing the guide bar against the wood. Use only light pressure and let the saw do the work.
- Maintain a steady speed throughout the cut releasing pressure just before the end of the cut.
- Know the location of the 6 meter cord at all times to avoid trip hazards and avoid cutting the 6 meter cord.
- Know the location of the tip of the bar at all times and avoid contact with other objects.
- If the saw stops suddenly when cutting, remove the saw from the cut, then resume cutting using lighter pressure on the work piece.

PRUNING

▲ CAUTION: Falling limbs may bounce or “spring back” after they hit the ground so it is essential to keep the ground clear to provide multiple retreat paths. Clear the work area and wear head protection.

Pruning is removing dead or overgrown branches to maintain plant health.

- Plan retreat paths before beginning to cut, and make sure there are no obstructions. Always know how to get out of the way of falling branches.
- Make sure bystanders or helpers are a safe distance from falling branches. Bystanders or helpers should not stand directly in front of or behind the operator. See Fig. 16.
- Maintain solid footing and hold the chainsaw firmly with both hands. Do not overreach. Never climb a tree or ladder to reach high limbs.
- Secure any branches that might be hazardous.
- Use proper auxiliary equipment.
- Prune lower limbs before pruning higher ones.
- Allow the saw chain to achieve full speed before cutting.
- Apply light pressure to the branch.
- For long limbs (Fig. 17), cut the end of the limb first (1) to relieve pressure from the limb, then prune closer to the trunk (2).

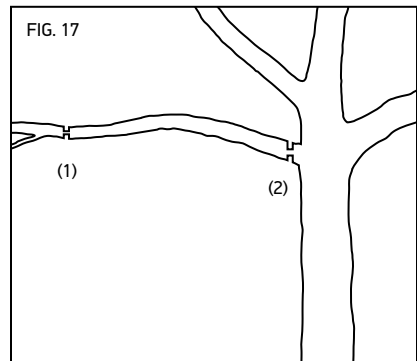

- Thick limbs (greater than 10 cm (4 inch) in diameter) can splinter or pinch the chain when making a single cut from the top. To avoid pinching or splintering, first make one shallow relief cut on the bottom surface of the limb (1), then cut the limb all of the way through from the top of the limb (2) to match the bottom cut (Fig. 18).

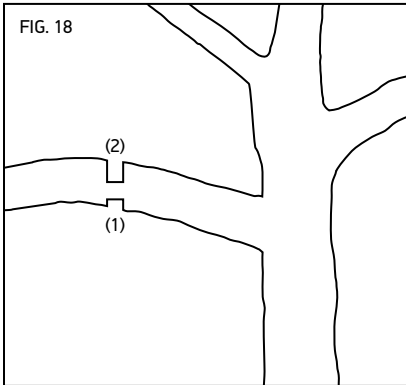

- After most of the limb has been removed, make one smooth cut near the trunk (Fig. 19).

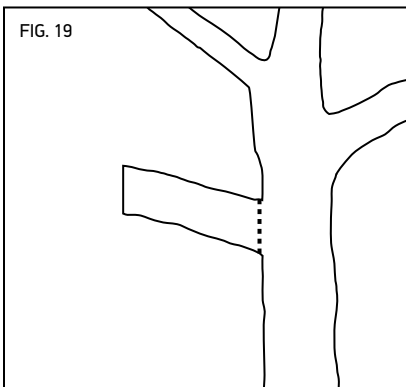

FELLING A TREE

⚠ CAUTION: A tree is likely to roll or slide downhill after it is felled. Plan and clear a retreat path before cuts are started. The retreat path should extend back and diagonally to the rear of the expected line of fall (Fig. 20).

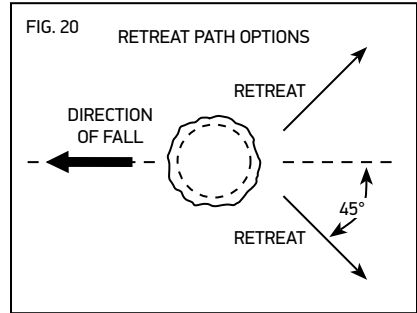

Felling is cutting down a tree.

- Before felling is started, consider the natural lean of the tree, the location of larger branches and the wind direction to judge which way the tree will fall.
- Remove dirt, stones, loose bark, nails, staples and wire from the tree where felling cuts are to be made.
- When bucking and felling operations are being performed by two or more persons at the same time, separate the felling operation from the bucking operation by a distance of at least twice the height of the tree being felled.
- Trees should not be felled in a manner that would endanger any person, strike any utility line or cause any property damage. If the tree contacts any utility line, immediately leave the area and notify the utility company.
- Use the metal spikes on the front of the saw to support the saw on the wood. Set metal spiked bumper into the wood and use as a leverage point to increase stability when cutting large diameter wood.

Notching Undercut

- First, make the notch 1/3 the diameter of the tree perpendicular to the direction of fall. Make the lower horizontal notching undercut first (1). This will help to avoid pinching of either the saw chain or the guide bar when the second cut (2) is being made (Fig. 21).

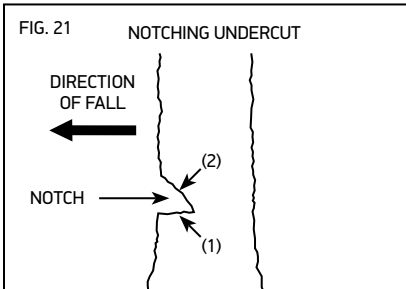

Felling Back Cut

- Second, make the felling back cut at least 50 mm (2 in.) higher than the horizontal notching undercut (Fig. 22). Keep the felling back cut parallel to the horizontal notching undercut.

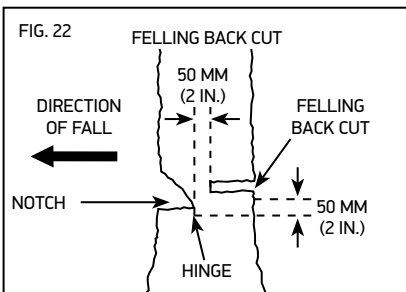

- Make the felling back cut so enough wood is left to act as a hinge. The hinge wood keeps the tree from twisting and falling in the wrong direction. Do not cut through the hinge.
- As the felling cut gets close to the hinge, the tree should begin to fall.

- If there is any chance that the tree may not fall in the desired direction or it may rock back and bind the saw chain, stop cutting before the felling back cut is complete and use wedges of wood, plastic or aluminium to open the cut and drop the tree along the desired line of fall.

- When the tree begins to fall, remove the chainsaw from the cut, stop the motor, put the chainsaw down, then use the retreat path planned.

- Be alert for overhead limbs falling and watch footing.

Limbing a Tree

⚠ CAUTION: Limbs under tension can “spring back” and contact the operator or throw the chainsaw out of control resulting in personal injury. Always be alert for wood under tension which may strike the operator or chainsaw when cut.

Limbing is removing the branches from a fallen tree.

- When limbing, leave larger lower limbs to support the log off the ground.
- Remove the small limbs in one cut.
- Branches under tension should be cut from the bottom up to avoid binding the chainsaw (Fig. 23).

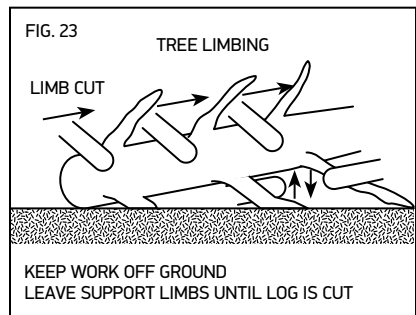

BUCKING A LOG

⚠ CAUTION: Bucking logs under tension increases the chance of kickback. Use one of the methods below to support the log when bucking.

Bucking is cutting a log into lengths. It is important to make sure footing is firm and weight is evenly distributed on both feet. When possible, the log should be raised and supported by the use of limbs, logs or chocks.

- When the log is supported along its entire length, cut from the top (overbuck) (Fig. 24).

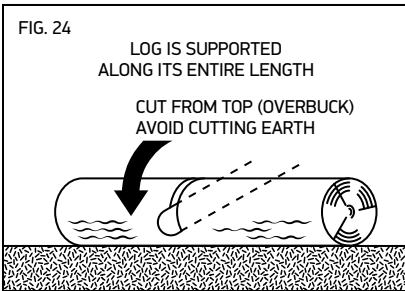

- When the log is supported on one end, cut 1/3 the diameter from the underside (underbuck), then make the finished cut by overbucking to meet the first cut (Fig. 25).

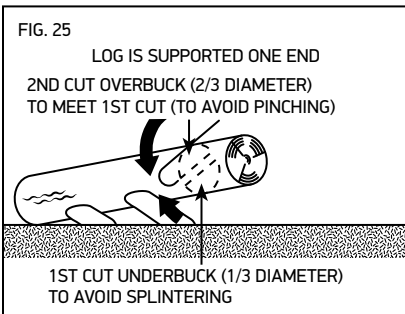

- When the log is supported on both ends, cut 1/3 of that diameter from the top overbuck, then make the finished cut by underbucking the lower 2/3 to meet the first cut (Fig. 26).

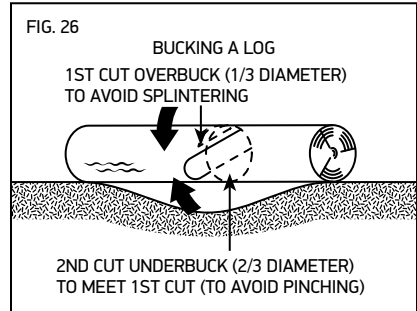

- When bucking on a slope, always stand on the uphill side of the log (Fig. 27).

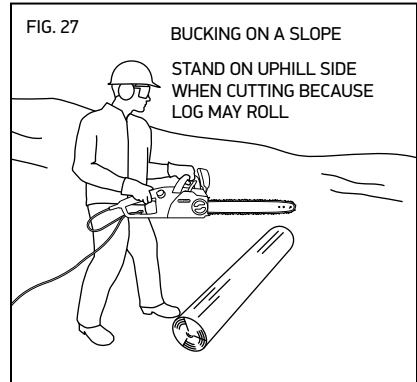

- To maintain complete control when cutting through, release the cutting pressure near the end of the cut without relaxing the grip on the chainsaw handles.
- Don't let the chain contact the ground.
- After completing the cut, wait for the saw chain to stop before you move the chain saw.
- Always stop the motor before moving from tree to tree.

Sharpening with PowerSharp®

⚠ WARNING: PowerSharp should not be used in the presence of exposed, extremely flammable materials such as gasoline and acetylene.

⚠ CAUTION: Sharpening with the PowerSharp system produces low energy sparks.

⚠ CAUTION: the PowerSharp integrated sharpening system is for use only with PowerSharp chain. Never attempt to sharpen other chain with the integrated sharpener. Damage to the chain and sharpener will occur.

INTRODUCTION TO POWERSHARP

This chainsaw is equipped with the PowerSharp integrated sharpening system, a fast and easy way to sharpen chain on the saw. It is time to sharpen the saw chain when cuts take longer or the wood chips become smaller, turning the saw to dust in extreme cases.

SHARPENING THE CHAIN

IMPORTANT: PowerSharp chain uses unique top-sharpening cutters and can only be sharpened with a genuine PowerSharp sharpener.

- With the saw at full speed, lightly lift the PowerSharp lever for 3 – 5 seconds (Fig. 28). Sparks will be visible when the cutters are in contact with the sharpening stone.

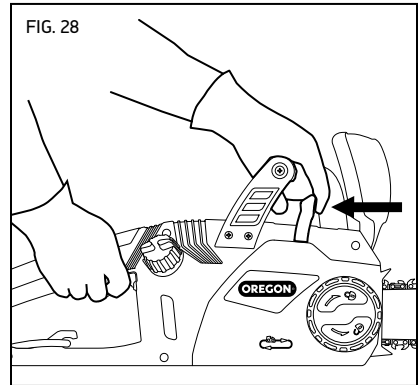

- Make a test cut to determine if the chain has been sufficiently sharpened. If not, repeat the sharpening procedure until the chain is sufficiently sharp.

IMPORTANT: Do not apply too much force when sharpening. Excessive force can reduce the performance of the sharpening stone.

IMPORTANT: It is normal to see a small amount of sparks and smoke during sharpening as the cutters contact the stone and friction heats the chain.

WHEN TO REPLACE THE SHARPENING STONE

The sharpening stone is designed to wear at the same rate as the chain. Always replace the stone when replacing the chain even if it appears to have more life. See "Replacing a Worn Saw Chain and Sharpening Stone" in this manual.

Maintenance and Cleaning



⚠ WARNING: Failure to identify and replace damaged or worn parts can cause serious personal injury. Inspect the chainsaw regularly. Regular inspection is the first step to proper maintenance. Follow the guidelines below to maximise safety and satisfaction. Have any damaged or excessively worn parts replaced immediately.

⚠ WARNING: An electric power tool that is plugged in can start accidentally. Unplug the chainsaw before preparing for use or performing maintenance.

⚠ CAUTION: When cleaning the chain saw, do not immerse in water or other liquids.

Inspection

Before each use and if the chainsaw has been dropped, inspect these parts:

- 6 Meter Cord: Ensure the plug is in good condition and not bent or corroded, and that the insulation is intact. If the 6 meter cord is damaged, do not use. Contact an authorised service dealer.
- Handles: Front and rear handles should not have cracks or other damage. They should be clean and dry.
- Front Hand Guard: The front hand guard should be free of damage and able to move easily back and forth. When moved, the front hand guard should activate the chain brake.
- Guide Bar: The bar should be straight and free of chips, cracks or excessive wear.
- Saw Chain: The chain should be properly tensioned and sharp and all components free of cracks, chips, broken teeth or excessive wear. See “Tensioning the Saw Chain” and “Sharpening with PowerSharp®”.

- Side Cover: The side cover should be free of cracks or other damage. It should fit tightly to the saw body with no warping. Make sure the chain catcher is free of cracks.
- Chain Brake: Test the chain brake to make sure it is functioning properly. See “Testing the Chain Brake” under “General Operation.”
- Oil Level: Make sure the oil reservoir is full before use.
- Motor Housing: Check for cracks in the cover and debris in the air intake vents.

Periodically inspect these parts:

- Drive Sprocket: Look for deep grooves, broken teeth or burrs.
- Chain Tensioning Gear: Inspect the gear for cracks, chips, loose screw, warping or other damage.
- Bar-Mounting Area Underneath Side Cover: Make sure the bar mounting stud is not bent, stripped or cross-threaded and that the bar pad and alignment flange are free of debris and intact.

Cleaning

⚠ CAUTION: When cleaning the chainsaw powerhead, do not immerse in water or other liquids.

- Wear gloves.
- Unplug the chainsaw.
- Remove wood chips and other debris from the motor housing and the vents.
- Always clean out wood chips, saw dust and dirt from the bar groove when replacing the chain.
- Make sure the 6 meter cord and plug are dry before connecting to an outlet.

Maintaining the Guide Bar

⚠ CAUTION: The guide bar can be hot after cutting. Wear gloves to avoid burns.

To even bar wear and maximise bar life, flip the bar occasionally.

- Wear gloves.
- Unplug the chainsaw.
- Loosen the side cover release knob slightly, but do not remove the side cover.
- Loosen the chain tensioning ring (turn it counter clockwise) as far as it will go.
- Loosen the side cover release knob and remove the side cover.
- Remove the bar and chain and inspect for damage and wear.
- Remove the screw from the back side of the chain tensioning gear and remove the chain tensioning gear from the guide bar (Fig. 29).

FIG. 29

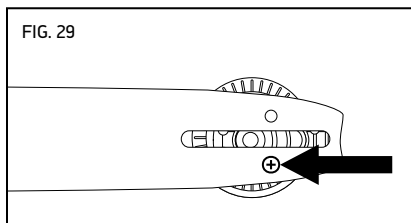

- Flip the bar (Fig. 30).

FIG. 30

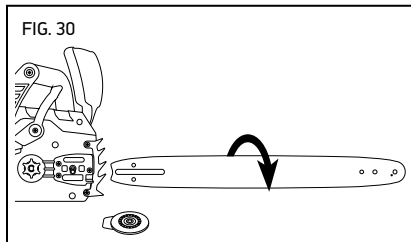

- There is a rubber washer that is important to the function of the saw. The rubber washer must be in place around the pin on the tensioner before the tensioner is screwed onto the bar (Fig. 31).

FIG. 31

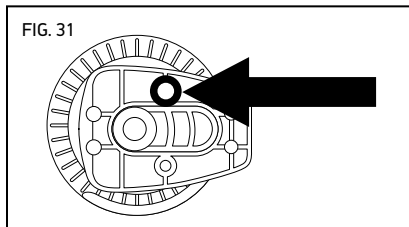

- Place the chain tensioning gear on the side of the guide bar facing you such that the rectangular piece does not protrude past the edges of the guide bar and replace the screw.
- Place the guide bar on the bar pad by sliding the bar slot over the alignment flange (Fig. 32).

FIG. 32

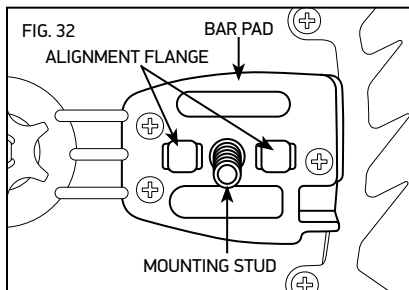

- Replace the saw chain as described in "Replacing a Worn Saw Chain and Sharpening Stone".
- Tension the chain as described in "Tensioning the Saw Chain" in the "Preparing for Use" section of the manual.

Replacing a Worn Saw Chain and Sharpening Stone

⚠ CAUTION: Replace PowerSharp® saw chain and the sharpening stone at the same time. Failure to do so could result in decreased performance or damage to the chain and/or sharpening stone.

⚠ CAUTION: The PowerSharp integrated sharpening system is for use only with PowerSharp chain. Remove the sharpening stone when using saw chain other than PowerSharp. Failure to do so may result in damage to the saw chain, sharpening system and/or chainsaw.

When the saw chain becomes cracked or has broken teeth, is stretched to the point that it cannot be kept at proper tension or simply cannot be sharpened, it must be replaced.

- Wear gloves.
- Unplug the chainsaw.
- Loosen the side cover release knob slightly, but do not remove the side cover.
- Loosen the chain tensioning ring (turn it counter clockwise) as far as it will go.
- Loosen the side cover release knob and remove the side cover.
- Remove the saw chain.
- Remove the two screws holding the sharpening stone (Fig. 33).

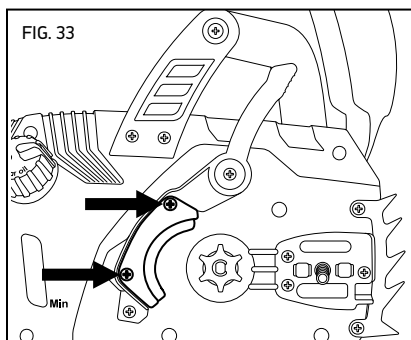

- Remove the stone.
- Make sure the PowerSharp lever and surrounding area are free of debris.
- Place the new stone on the lever and replace the screws.
- Loop the new saw chain onto the drive sprocket so that the cutting edges of the teeth along the top of the bar face away from the powerhead (Fig. 34).

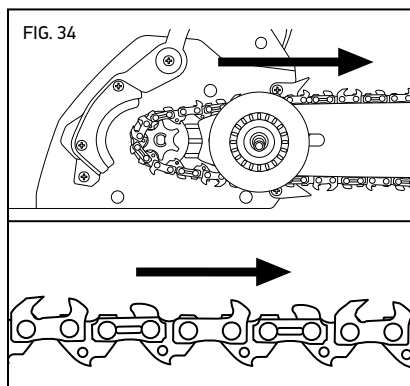

- Feed the chain into the groove of the bar and slide the bar away from the motor to remove slack from the chain (Fig. 35).

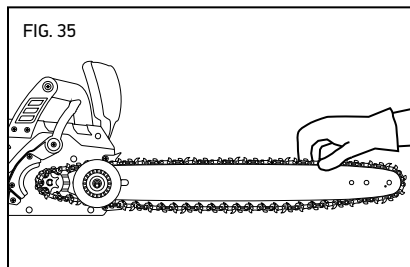

- Install the side cover, making sure the chain catcher is properly seated in its hole, then lightly tighten the side cover release knob (Fig. 36).

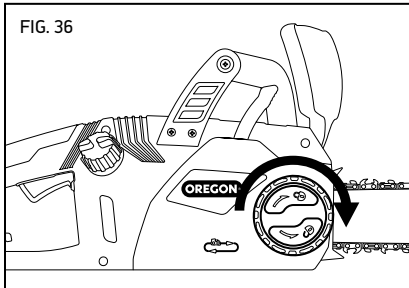

- Tension the chain as described in “Tensioning the Saw Chain” in the “Preparing for Use” section of the manual.

IMPORTANT: The saw chain must be properly tensioned before using. See “tensioning the saw chain” in the “preparing for use” section of the manual.

Replacing a Worn Guide Bar

⚠ WARNING: The edges of a worn guide bar, particularly the edges of the groove where the chain touches the bar, can be extremely sharp. Use appropriate hand protection.

When the guide bar becomes cracked or has excessive wear around the edges, particularly in the groove where the saw chain touches the bar, it must be replaced. Also, if the nose sprocket is worn, has teeth missing or does not turn smoothly, the bar must be replaced.

- Wear gloves.
- Unplug the chainsaw.
- Loosen the side cover release knob slightly, but do not remove the side cover.
- Loosen the chain tensioning ring (turn it counter clockwise) as far as it will go.
- Loosen the side cover release knob and remove the side cover.
- Remove the bar and chain.

- Remove the screw from the back side of the chain tensioning gear and remove the chain tensioning gear from the guide bar as described in “Maintaining the Guide Bar”.
- Place the chain tensioning gear on the new guide bar and replace the screw.
- Replace the guide bar as described in “Maintaining the Guide Bar”.
- Replace the chain as described in “Replacing a Worn Saw Chain and Sharpening Stone”.
- Tension the chain as described in “Tensioning the Saw Chain”.

Replacing a Worn Chain Tensioning Gear

Replace the chain tensioning gear if it will not hold the bar and chain at proper tension or if it is otherwise damaged.

- Wear gloves.
- Unplug the chainsaw.
- Loosen the side cover release knob slightly, but do not remove the side cover.
- Loosen the chain tensioning ring (turn it counter clockwise) as far as it will go.
- Loosen the side cover release knob and remove the side cover.
- Remove the bar and chain.
- Remove the screw from the back side of the chain tensioning gear and remove the chain tensioning gear from the guide bar as described in “Maintaining the Guide Bar”.
- Place the new chain tensioning gear on the side of the guide bar facing you, and replace the screw.
- Place the guide bar on the bar pad by sliding the bar slot over the alignment flange as described in “Maintaining the Guide Bar”.
- Replace the saw chain as described in “Replacing a Worn Saw Chain and Sharpening Stone”.
- Tension the chain as described in “Tensioning the Saw Chain” in the “Preparing for Use” section of the manual.

Replacing the Drive Sprocket

Replace the drive sprocket after every two saw chain replacements or when the sprocket is damaged.

- Wear gloves.
- Unplug the chainsaw.
- Loosen the side cover release knob slightly, but do not remove the side cover.
- Loosen the chain tensioning ring (turn it counter clockwise) as far as it will go.
- Loosen the side cover release knob and remove the side cover.
- Remove the bar and chain.
- Use a small flat screwdriver to pry open and remove the e-clip, then remove the drive sprocket and spring (Fig. 37).

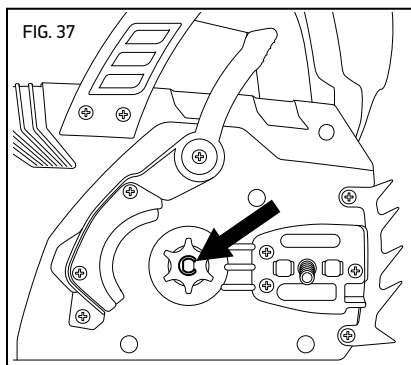

- Insert the new spring and drive sprocket, and install the new e-clip (Fig. 38).

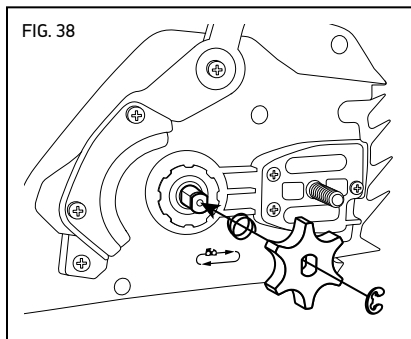

- Replace the bar and chain as described in “Replacing a Worn Saw Chain and Sharpening Stone”.
- Tension the chain as described in “Tensioning the Saw Chain” in the “Preparing for Use” section of the manual.

Tensioning the Saw Chain

IMPORTANT: Only tension the saw chain when the chain is cool. A hot chain may contract and damage the guide bar or chain as it cools.

If the chain does not touch the underside of the bar when the chainsaw is off and cool, it should be tensioned.

Tension the chain as described in “Tensioning the Saw Chain” in the “Preparing for Use” section of the manual.

Additional Maintenance Information

For further information on maintaining the saw chain, guide bar and drive sprocket, consult the Oregon Maintenance and Safety Manual at <http://OregonProducts.com/maintenance/manual.htm>.

Troubleshooting

Use this table to see possible solutions for problems with the chainsaw. If these suggestions do not solve the problem, see “Warranty and Service”.

SYMPTOM	POSSIBLE CAUSE	RECOMMENDED ACTIONS
Motor stops while cutting	Chain pinched in cut	Undercut limb to relieve pressure on limb. See “Cutting”.
	Cord is damaged or severed	If extension cord is damaged, do not use and replace it. If chainsaw cord is damaged, do not use and contact an approved service location.
	Chain brake is engaged	Set the front hand guard to the operating position as described in “Checking the Front Hand Guard Position”.
Motor does not run or runs intermittently	Saw is not plugged in	Plug in the saw.
	Cord is damaged or severed	If extension cord is damaged, do not use and replace it. If chainsaw cord is damaged, do not use and contact an approved service location.
	GFCI outlet is tripped	Unplug extension cord, reset GFCI and plug the extension cord back in.
	Bad electrical outlet	Plug extension cord into a different outlet.
	Chain brake engaged	Set the front hand guard to the operating position as described in “Checking the Front Hand Guard Position”.
	Trigger lock-out not pressed	Press the trigger lock-out before squeezing the trigger switch. See “General Operation”.
	Debris in side cover	Unplug the chainsaw, then remove side cover and clean out debris.
Motor does not stop when chain brake is engaged	Debris preventing full movement of front hand guard	Clean debris from external chain brake mechanism.
	Possible chain brake malfunction	⚠ WARNING: Operating a chainsaw without a functioning chain brake could lead to serious personal injury. Contact an approved service location before using.
Motor runs, but saw chain does not rotate	Chain not engaging drive sprocket	Reinstall the chain, making sure the drive links on the chain are fully seated on the drive sprocket. See “Replacing a Worn Saw Chain and Sharpening Stone”.
	Guide bar nose sprocket is not turning	Replace the guide bar. See “Replacing a Worn Guide Bar”.

SYMPTOM	POSSIBLE CAUSE	RECOMMENDED ACTIONS
Chainsaw does not cut properly	Insufficient chain tension	Tension the chain. See “Tensioning the Saw Chain” in the “Preparing for Use” section of the manual.
	Dull chain	See “Sharpening with PowerSharp®”.
	Chain installed backwards	Install the chain with the teeth facing the correct direction. See “Replacing a Worn Saw Chain and Sharpening Stone”.
	Worn chain	Replace the chain. See “Replacing a Worn Saw Chain and Sharpening Stone”.
	Dry or excessively stretched chain	Check the oil level. Refill oil reservoir if necessary. See “Filling the Bar and Chain Oil Reservoir”.
	Chain not in bar groove	Reseat chain onto groove. See “Replacing a Worn Saw Chain and Sharpening Stone”.
Chain loosening or coming off of guide bar	Side cover not installed correctly	Properly install side cover ensuring the tab at rear of side cover is tucked into saw body.
Bar and chain excessively hot and / or smoking	Chain is under-lubricated	Check the oil level. Refill oil reservoir if necessary. See “Filling the Bar and Chain Oil Reservoir”.

Specifications and Components

⚠ WARNING: Using replacement parts other than those specified in this instruction manual increases the risk of injury. Never use cutting attachments other than those described in this manual. Serious or even fatal injuries could result if the wrong cutting attachments are used.

REPLACEMENT COMPONENTS	PART NUMBER
Guide bar	180SDEA041
91PS062X saw chain and stone, PowerSharp®	571037
Drive sprocket	570964
Chain tensioning gear	570963
CHAINSAW SPECIFICATIONS	
Voltage	230 VAC ~50 Hz
Amperage	10.4 amps
Power	2400 watts
Oil capacity	140 ml (4.7 oz)
Bar and chain oil	Oregon® brand
Dry weight assembled	5.7 kg (12.6 lb)
Dry weight without bar and chain	4.8 kg (10.6 lb)
Guaranteed sound power level L _{wa} (1) (2)	110 dBA (K _{wa} =2.5 dBA)
Vibration	4.35 m / s ² (k=1.5 m / s ²)
Max bar length	450 mm (18 inches)
Effective cutting length	43 cm (17 inches)
Chain pitch	3/8" Low profile™
Chain gauge	.050"
Drive sprocket teeth	6
No load chain speed	14.7 m / s (48.1 ft / s)

(1) According to Noise Directive 2000/14/EC, amended by 2005/88/EC

(2) Measured according to EN 60745-1:2009+A11:2010 and EN60745-2-13:2009+A1:2010;
Sound Pressure level, L_{pA}, is 96dB(A) with an uncertainty K_{pA} of 2.5dB(A)

Warranty and Service

Warranty

Blount, Inc. warrants all registered Oregon® CS1500 chainsaws for a period of three (3) years. This warranty is valid only for units that have been used for personal use that have not been hired or rented, or used for commercial or industrial use. During the warranty period, Blount will replace or, at its option, repair for the original purchaser only, free of charge, any product or part which is found upon examination by Blount to be defective in material and/or workmanship. The purchaser shall be responsible for all transportation charges and any cost of removing any part submitted for replacement under this warranty.

Keep Original Receipt

Please attach original receipt from initial purchase to this manual and file. For warranty service, please bring product and receipt to the dealer where product was purchased. Or contact Oregon by telephone.

Service and Support Information

Visit us on the web at **OregonProducts.com** for service centre information, or contact our customer service department for assistance, additional technical advice, repair, or replacement parts.

For safety, use only genuine factory replacement parts on the chainsaw. Our service centre is staffed with trained personnel to efficiently provide support and assistance with adjustment, repair, or replacement of all Oregon products.

EC – Declaration of Conformity

Blount International Inc.
4909 SE International Way
Portland Oregon, 97222 USA

Blount International Inc. declares under our sole responsibility that the following products:

Brand:	Oregon®
Product Type:	Chainsaw
Model:	CS1500

Are compliant with the following applicable European directives and standards:

Machinery Directive 2006/42/EC; based on EC type examination carried out by:
TÜV Rheinland LGA Products GmbH (NB 0197)
Tillystraße 2 D - 90431 Nürnberg, Germany; 0197
Safety standards: EN 60745-1:2009+A11:2010, EN 60745-2-13:2009+A1:2010
EC type-examination certificate number: BM 50284318

Electromagnetic Compatibility (EMC) 2014/30/EU

EN 55014-1:2006 +A1 +A2
EN 55014-2:1997 +A1 +A2
EN 61000-3-2:2006 +A1 +A2
EN 61000-3-11:2000

Restriction of Hazardous Substances (RoHS) 2011/65/EU

Waste Electrical and Electronic Equipment (WEEE) 2012/19/EU

Noise Directive (ODN) 2000/14/EC according to ANNEX V

Measured Sound Power = 107 dB(A)
Uncertainty, KWA = 2.5 dB(A)
Guaranteed Sound Power, LWA = 110 dB(A)

Technical documentation file, locaton and contact:

Chris Seward



Director – Product Safety and Compliance

Blount International Inc.
Portland Or. 97222 USA

Michael Winkler

Blount International-Europe-S.A.

Rue Emile Francqui, 5

1435 Mont-Saint-Guilbert

Belgium

Date / Place:

08DEC2015, Portland OR. USA

Customer Service

UK

0-800-098-8536

info@blount.be

Imported by

Blount Europe SA
Rue Emile Francqui, 5
B 1435 Mont-Saint-Guibert, Belgium
+32 10 30 11 11



OregonProducts.com

Blount International Inc.
4909 Southeast International Way
Portland, OR 97222-4679 USA