



ROUND POST ADAPTER

Installation Instructions

English.....	1
Français.....	7
Español.....	13



Read all instructions prior to installing product.
Refer to manufacturers safety instructions when operating any tools.

To register your product, please visit: barretteoutdoorliving.com

WARNING:

- Improper installation of this product can result in personal injury. Always wear safety goggles when cutting, drilling and assembling the product.
- Incorrect installation may cause harm to the gate or individual.

NOTICE:

- DO NOT attempt to assemble the kit if parts are missing or damaged.
- DO NOT return the product to the store, for assistance or replacement parts call: 1-877-265-2220.

BEFORE YOU BEGIN:

Always refer to, confirm, and install this latch in accordance to your local barrier codes.

NOTE: Pool latch sold separately.

TOOLS NEEDED:

Gate
Safety Glasses
Pencil
Drill
1/8" Drill Bit - for pre-drill if needed
Phillips Drive
Square Drive (Optional)
Tape Measure

Component list:

Item	QTY	Description
A	1	Striker Mounting Base to 1 1/8" Gate Frame
B	1	1 1/8" Gate Frame Adapter
C	2	2" Post Adapter
D	2	2 1/2" Post Adapter
E	2	Post Mounting Base to 3" Post
F	1	Post Mounting Base with Adjustment Screw
G	8	#10 x 1 1/4" Phillips/Square Drive Screws
H	4	#10 x 1" Phillips/Square Drive Screws

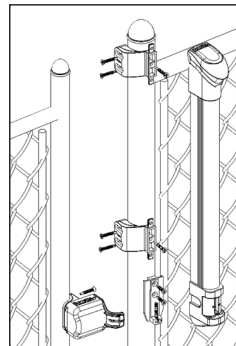
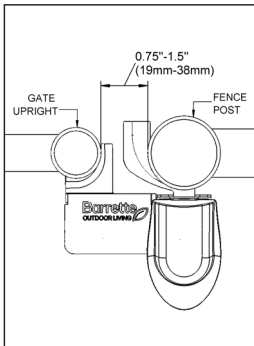
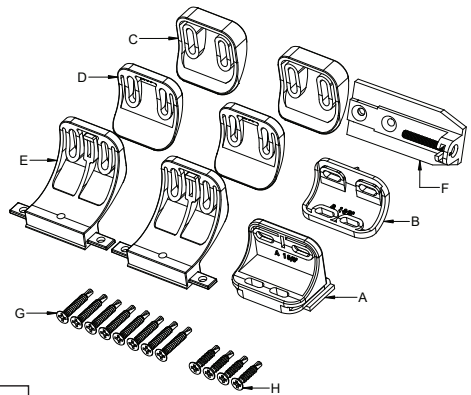

Left-Handed
Assembly

Right-Handed
Assembly

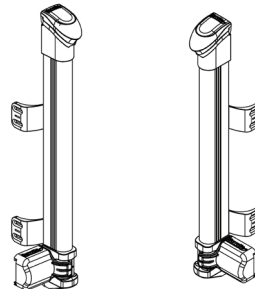

To obtain and review a copy of the warranty please visit: barretteoutdoorliving.com. You may also contact us at 1-877-265-2220 or email Cs.outdoorliving@ebarrette.com

1.

Determine size of your gate post, you can mount to posts that are 2", 2 1/2" or 3". Refer to images (Fig.1, Fig. 2, Fig. 3) to put together correctly.

NOTE:

Two are required for latch installation.

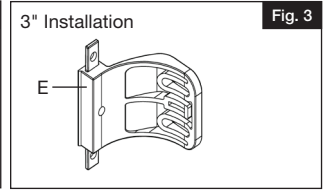
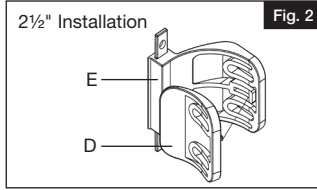
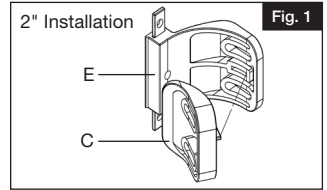

2.

Insert one of your bracket assembly from step 1 into the base as illustrated (Fig. 4). Refer to Figure 5 for right-handed installation.

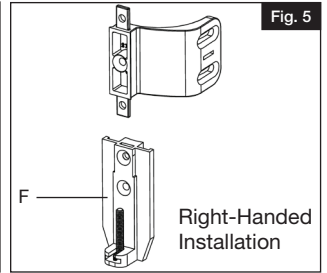
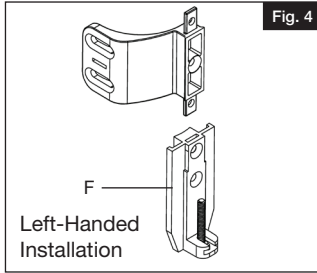

3.

Disassemble the A & B brackets off of the pool latch (sold separately) by unscrewing the adjustment screw and removing the brackets (Fig. 6).

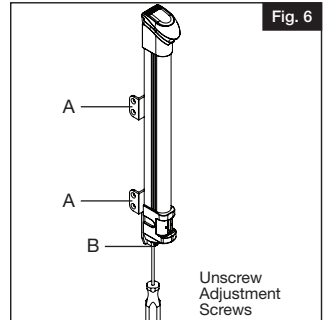

4.

Install new brackets from steps 1 & 2 above onto the latch as illustrated (Fig. 7) & tighten adjustment screw until F bracket is flush with the bottom of latch.

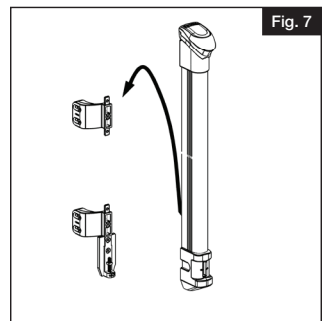

5.

Before you install determine desired height of the installation. At the correct height, mark bottom of latch (Fig. 8). Align the bottom of the latch to the pencil mark.

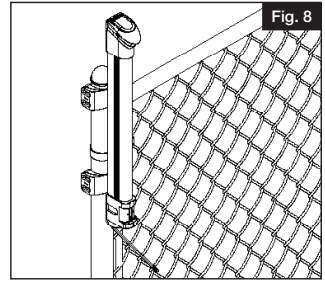

6.

While holding latch at the correct height (use bottom mark) mark bottom bracket holes, pre-drill, and install two #10 x 1¼" G screws (Fig. 9).

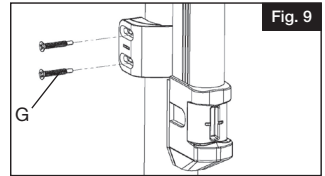

7.

Position top bracket ¼" from post cap. Mark holes, pre-drill, and install two #10 x 1¼" G screws (Fig. 10).

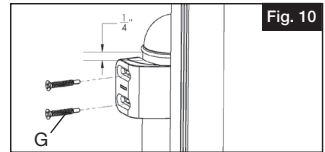

8.

Unscrew adjustment screw and remove pool latch (Fig. 11).

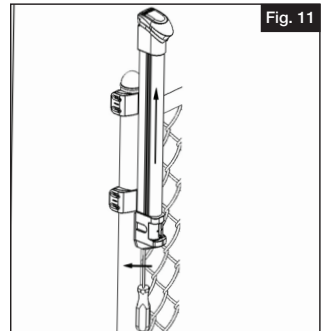

9.

Pre-drill and install four #10x 1¼" G screws (Fig. 12).

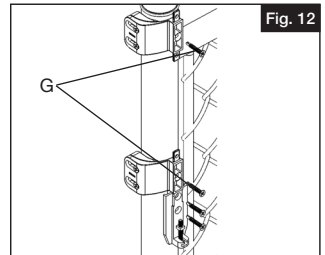

10.

Re-attach pool latch and screw in adjustment screw until bottom of mounting bracket F is flush with bottom of latch (Fig. 13).

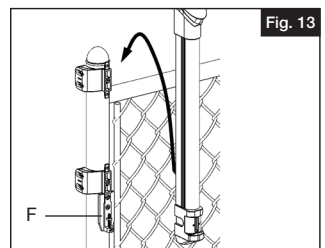

- 11.** Taking the striker from the pool latch kit, remove the four small screws holding the cover in place and then remove the cover. Next unscrew adjustment screw holding mounting bracket and remove mounting bracket (Fig. 14).

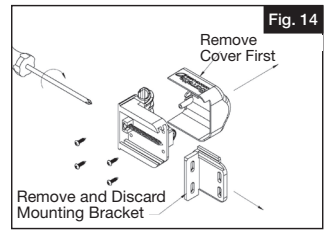

- 12.** Install round post mounting bracket A and turn the adjustment screw clockwise until bracket is engaged as illustrated (Fig. 15). Next replace the cover to previous position and replace the four small screws.

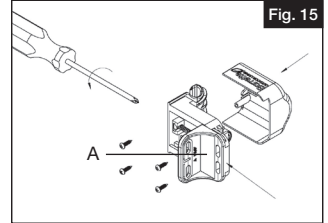

- 13.** Determine gate upright size. If 1 1/2", only use gate bracket (A) (Fig. 16). If 1 3/4" use adapter (B) with gate bracket (A) (Fig. 17).

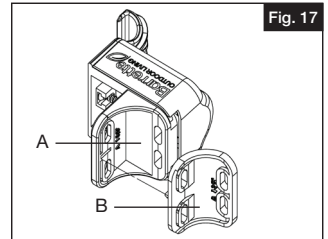
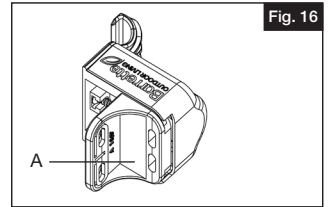

- 14.** Position striker assembly on the gate upright and align the vertical alignment marks. Then using a pencil make a small mark on the gate upright just above and to the side of the striker assembly (Fig. 18).

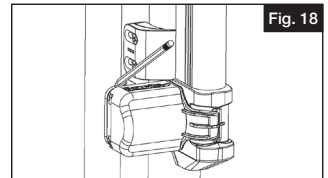

- 15.** Release the striker assembly from the latch assembly by lifting up on the latch release cap (Fig. 19).

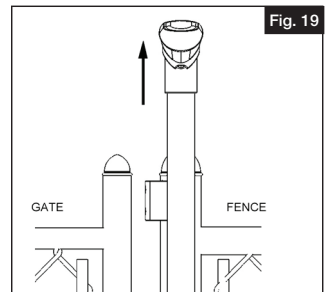

16. Open gate and reposition the striker assembly if it moved, on the gate upright where you previously marked and install two #10 x 1" H screws (Fig. 20).

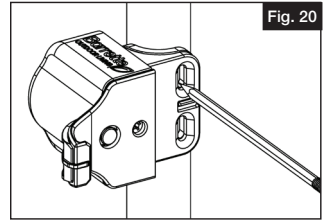

17. Pre-drill and install side screws into striker bracket (Fig. 21).

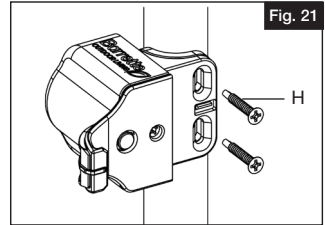

18. Expose other mounting holes by adjusting the striker assembly out away from the gate using a screwdriver (Fig. 22).

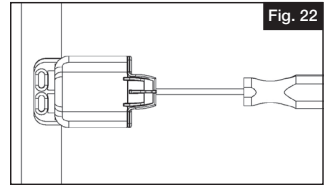

19. Install two #10 x 1" H screws (Fig. 23).

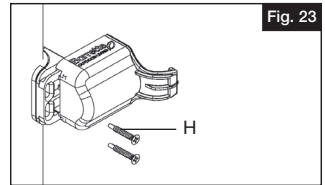

20. Adjust the striker adjustment screw (Fig. 24) until the striker and latch align as illustrated in Figure 25.

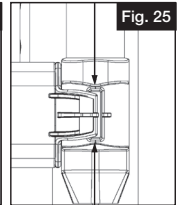
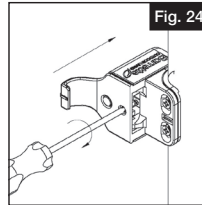

21. Hold the gate close to the latch assembly and adjust the vertical adjustment screw under the latch assembly and/or the horizontal adjustment screw on the striker assembly until the alignment looks like Figure 26.

NOTE:

This latch will not function properly if the striker & latch assembly is not aligned as illustrated.

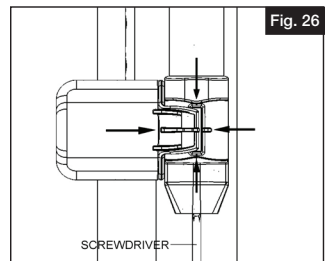



ADAPTATEUR DE POTEAU ROND

Instructions d'installation

English.....	1
Français.....	7
Español.....	13



Lire toutes les instructions avant d'installer le produit.
Consulter les consignes de sécurité du fabricant lors de l'utilisation des outils.

Pour enregistrer votre produit, veuillez visiter: barretteoutdoorliving.com

AVERTISSEMENT:

- Une mauvaise installation du produit peut causer des blessures. Toujours porter des lunettes de sécurité lors de la coupe, du perçage et de l'assemblage du produit.
- Une installation incorrecte est susceptible de causer des dommages au produit ou des blessures à l'individu.

AVIS:

- NE PAS tenter d'assembler le kit s'il y a des pièces endommagées ou manquantes.
- NE PAS retourner le produit au magasin. Pour obtenir de l'aide ou des pièces de remplacement, composer le 1-877-265-2220.

AVANT DE COMMENCER:

Toujours installer ce loquet conformément aux exigences du code du bâtiment local pour ce type de produit.

NOTE:

Les loquets pour les barrières de piscine sont vendus séparément.

OUTILS NÉCESSAIRES:

Barrière
Lunettes de sécurité
Crayon
Perceuse
Foret 1/8 po (3,2 mm) pour avant-trous, au besoin
Embout Phillips
Embout carré (facultatif)
Ruban à mesurer

Liste de composants:

Article	Quant.	Description
A	1	Base de montage de gâche pour montant de barrière de 1-5/8 po (41,3 mm)
B	1	Adaptateur pour montant de barrière de 1-3/8 po (35 mm)
C	2	Adaptateurs de poteau de 2 po (50 mm)
D	2	Adaptateurs de poteau de 2-1/2 po (63,5 mm)
E	2	Bases de montage pour poteau de 3 po (76 mm)
F	1	Base de montage de poteau avec vis de réglage
G	8	Vis no 10 x 1-1/4 po (32 mm) pour embout Phillips/carré
H	4	Vis no 10 x 1 po (25 mm) pour embout Phillips/carré

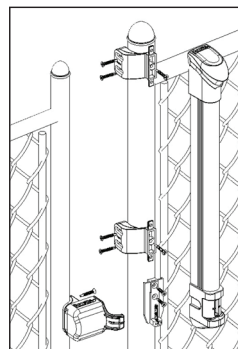
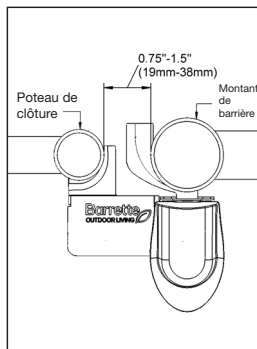
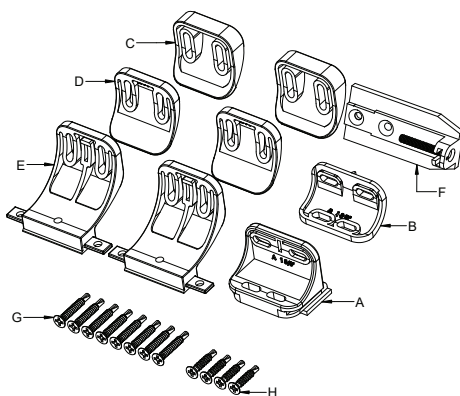

Assemblage à gauche

Assemblage à droite

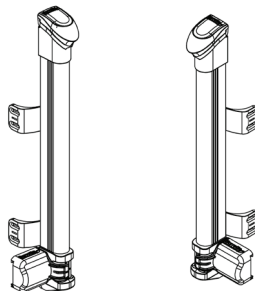

Pour obtenir et examiner une copie de la garantie, visiter: barretteoutdoorliving.com. Vous pouvez également nous appeler au 1-877-265-2220 ou nous envoyer un courriel à Cs.outdoorliving@ebarrette.com

1.

Déterminer la taille du poteau de barrière. Le montage peut se faire sur des poteaux de 2 po (50 mm), 2-1/2 po (63,5 mm) ou 3 po (76 mm). Voir les illustrations (Fig.1, Fig. 2, Fig. 3) pour un bon assemblage.

NOTE:

Deux sont nécessaires pour l'installation du loquet.

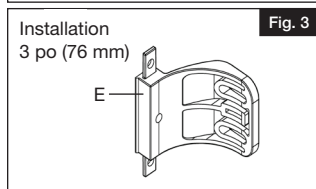
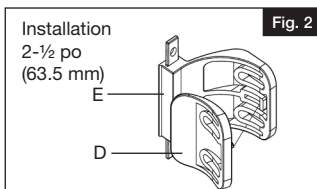
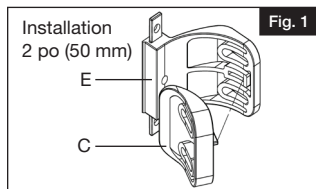

2.

Insérer l'assemblage de support de l'étape 1 dans la base comme illustré (Fig. 4). Se reporter à (Fig. 5) pour une installation à droite.

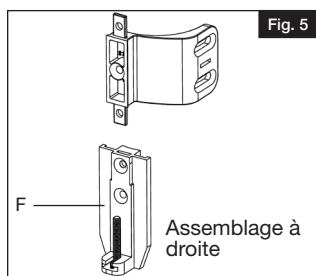
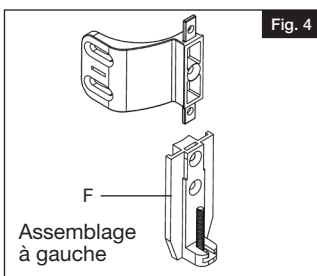

3.

Démonter les supports A et B du loquet de la barrière de piscine (vendu séparément) en dévissant la vis de réglage et en retirant les supports (Fig. 6).

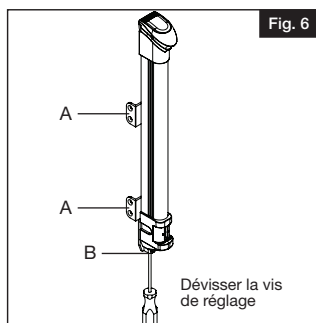

4.

Installer les nouveaux supports des étapes 1 et 2 ci-dessus sur le loquet comme illustré (Fig. 7) et serrer la vis de réglage jusqu'à ce que le support F affleure le bas du loquet.

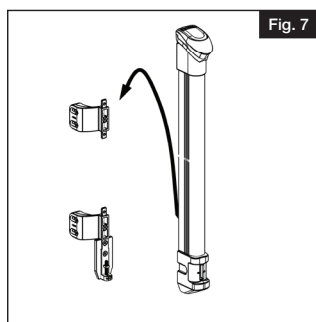

- 5.** Avant de procéder à l'installation, déterminer la hauteur souhaitée du loquet. À la bonne hauteur, marquer le bas du loquet (Fig. 8). Aligner le bas du loquet sur la marque au crayon.

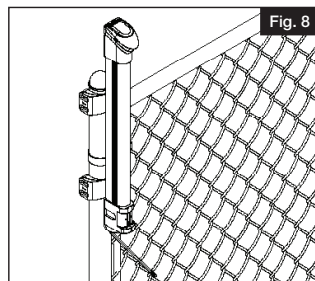

- 6.** Tout en maintenant le loquet à la bonne hauteur (en utilisant la marque du bas), marquer l'emplacement des trous du support inférieur, percer des avant-trous et enfoncer deux vis no 10 x 1-¼ po (32 mm) (Fig. 9 - G).

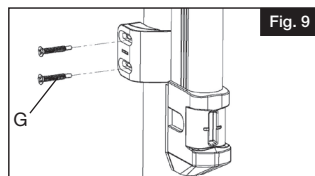

- 7.** Placer le support supérieur à ¼ po (6 mm) du capuchon de poteau. Marquer l'emplacement des trous, percer des avant-trous et enfoncer deux vis no 10 x 1-¼ po (32 mm) (Fig. 10 - G).

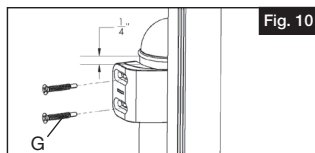

- 8.** Dévisser la vis de réglage et enlever le loquet de barrière de piscine (Fig. 11)

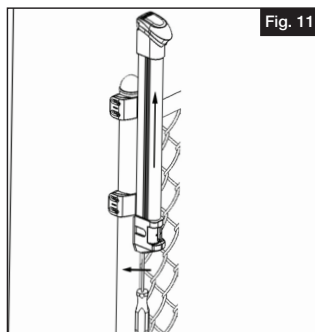

- 9.** Percer des avant-trous et enfoncer quatre vis no 10 x 1-¼ po (32 mm) (Fig. 12 - G).

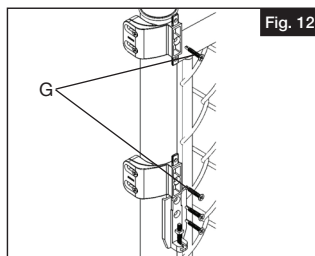

- 10.** Remettre le loquet de barrière de piscine en place et visser la vis de réglage jusqu'à ce que le bas du support de montage F soit aligné sur le bas du loquet (Fig. 13).

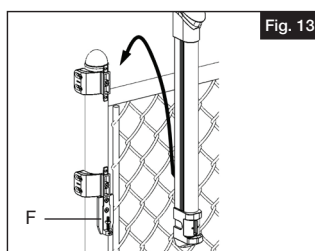

- 11.** Prendre la gâche dans le kit de loquet de barrière de piscine. Enlever les quatre petites vis qui maintiennent le couvercle en place, puis retirer le couvercle. Ensuite, dévisser la vis de réglage qui tient le support de montage en place et retirer le support de montage (Fig. 14).

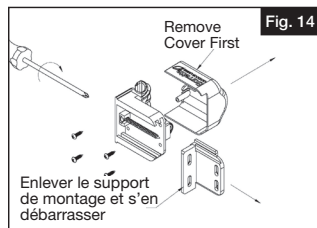

- 12.** Installer le support de montage de poteau rond A et faire tourner la vis de réglage dans le sens des aiguilles d'une montre jusqu'à ce que le support soit engagé comme illustré (Fig. 15). Ensuite, remettre le couvercle dans sa position précédente et replacer les quatre petites vis.

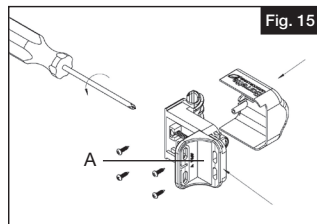

- 13.** Déterminer la taille du montant de la barrière. Si la taille est de 1-5/8 po (41,3 mm), utiliser uniquement le support de barrière (A) (Fig. 16). Si la taille est de 1-3/8 po (35 mm), utiliser l'adaptateur (B) avec le support de barrière (A) (Fig. 17).

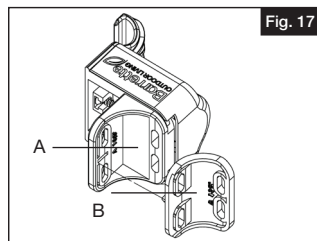
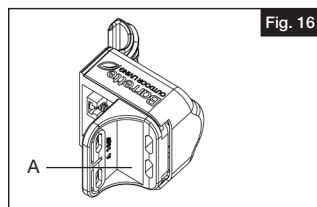

- 14.** Placer la gâche sur le montant de barrière et aligner les marques d'alignement verticales. Puis, à l'aide d'un crayon, faire une petite marque sur le montant de barrière juste au-dessus et sur le côté de la gâche (Fig. 18).

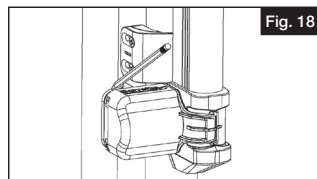

- 15.** Dégager la gâche du loquet en soulevant le capuchon de dégagement du loquet (Fig. 19).

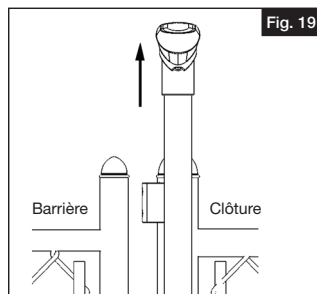

- 16.** Ouvrir la barrière et repositionner la gâche (si elle a bougé) sur le montant de barrière à l'endroit où l'on a fait une marque précédemment, et enfoncer deux vis no 10 x 1 po (25 mm) (Fig. 20 - H).

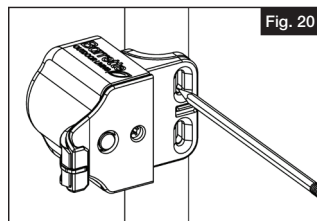

- 17.** Percer des avant-trous et enfoncer les vis latérales dans le support de gâche (Fig. 21).

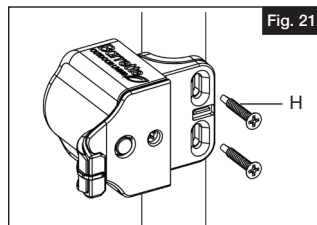

- 18.** Exposer les autres trous de montage en ajustant la gâche pour l'éloigner de la barrière à l'aide d'un tournevis (Fig. 22).

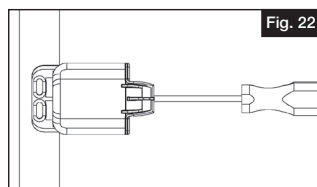

- 19.** Enfoncer deux vis no 10 x 1 po (Fig. 23 - H).

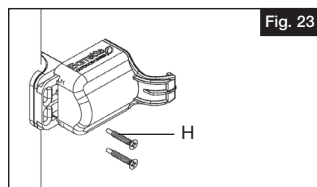

- 20.** Régler la vis de réglage de la gâche (Fig. 24) jusqu'à ce que la gâche et le loquet soient alignés comme illustré (Fig. 25).

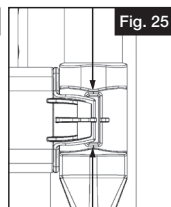
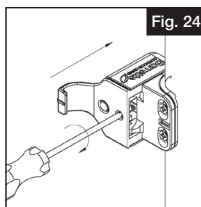

- 21.** Tenir la barrière près du loquet, et régler la vis de réglage vertical sous le loquet ou la vis de réglage horizontal sur la gâche jusqu'à ce que l'alignement ressemble celui de (Fig. 26).

NOTE:

Ce loquet ne fonctionnera pas correctement si la gâche et le loquet ne sont pas alignés comme illustré.

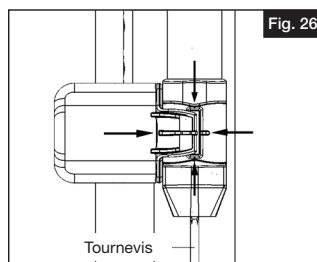



ADAPTADOR DE POSTE REDONDO

Instrucciones de instalación

English.....	1
Français.....	7
Español.....	13



Lea todas las instrucciones antes de instalar el producto.
Consulte las instrucciones de seguridad del fabricante al utilizar herramientas

Para registrar su producto, visite: barretteoutdoorliving.com

ADVERTENCIA:

- La instalación incorrecta de este producto puede resultar en lesiones corporales. Utilice siempre gafas de seguridad al momento de cortar, taladrar y ensamblar el producto
- La instalación incorrecta puede causar daños al portón o a personas.

AVISO:

- NO intentar ensamblar el kit si faltan piezas o las piezas están dañadas.
- NO devolver el producto a la tienda; para solicitar ayuda o piezas de repuesto, llame al: 1-877-265-2220.

ANTES DE COMENZAR:

Consulte, confirme e instale este cerrojo de acuerdo con los códigos de barrera locales.

NOTA:

El cerrojo de la piscina se vende por separado.

HERRAMIENTAS QUE SE REQUIEREN:

Portón
Gafas de protección
Lápiz
Taladro
Broca de 1/8" para taladrar en caso necesario
Punta de desarmador Phillips
Punta de desarmador cuadrada (opcional)
Cinta métrica

Lista de componentes:

Pieza	CTD	Descripción
A	1	Base de montaje de la traba en el marco de puerta de 1 3/8"
B	1	Adaptador de marco de portón de 1 3/8"
C	2	Adaptador de poste de 2"
D	2	Adaptador de poste de 2 1/2"
E	2	Base de montaje en poste de 3"
F	1	Base de montaje en poste con tornillo de ajuste
G	8	Tornillos Phillips/cuadrados #10 de 1 1/4"
H	4	Tornillos Phillips/cuadrados #10 de 1"

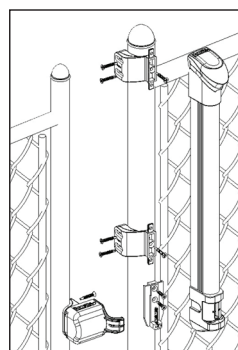
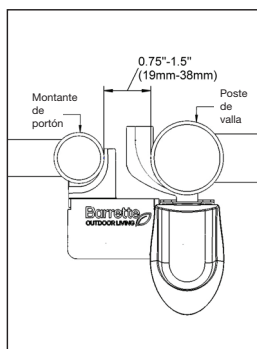
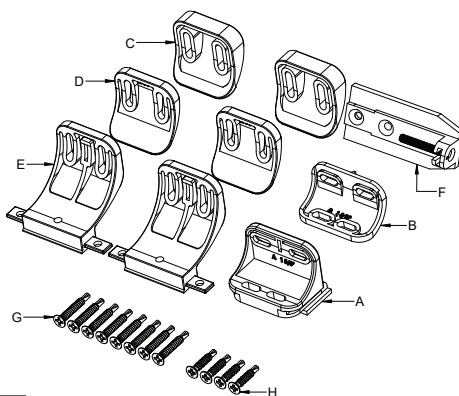

Montaje en el lado izquierdo

Montaje en el lado derecho

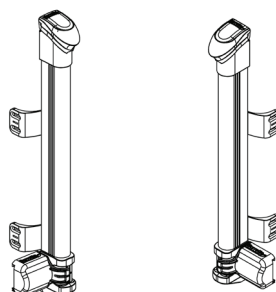

Pour obtenir et examiner une copie de la garantie, visiter: barretteoutdoorliving.com. Vous pouvez également nous appeler au 1-877-265-2220 ou nous envoyer un courriel à Cs.outdoorliving@ebarrette.com

1.

Determine el tamaño del poste de su portón. Puede montarlo en postes de 2", 2.5" o 3". Consulte las imágenes (Fig. 1, Fig. 2, Fig. 3) para montarlo correctamente.

NOTA:

Se necesitan dos para la instalación del cerrojo.

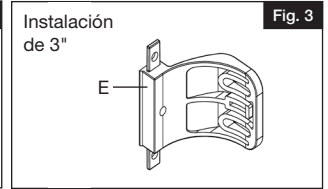
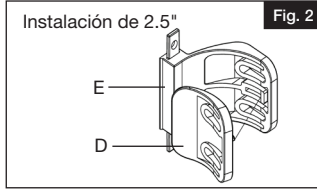
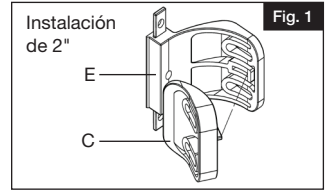

2.

Inserte uno de sus conjuntos de soportes del paso 1 en la base como se ilustra (Fig. 4). Consulte la Figura 5 para ver el Instalación en el lado derecho.

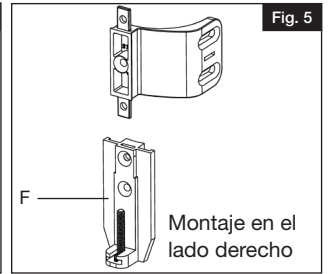
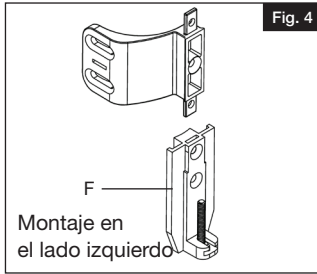

3.

Desmonte los soportes A y B del cerrojo de la piscina (se vende por separado) destornille el tornillo de ajuste y retirando los soportes (Fig. 6).

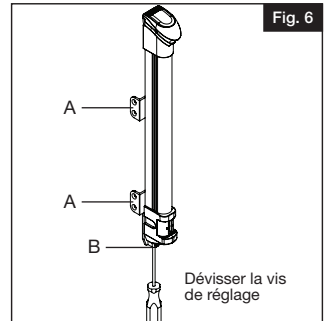

4.

Instale los nuevos soportes de los pasos 1 y 2 anteriores en el cerrojo como se ilustra (Fig. 7) y apriete el tornillo de ajuste hasta que el soporte F quede a ras de la parte inferior del cerrojo.

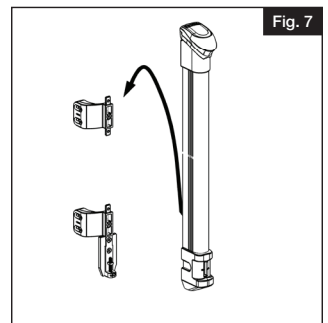

- 5.** Antes de instalar, determine la altura deseada de la instalación. A la altura correcta, marque la parte inferior del cerrojo (Fig. 8). Alinee la parte inferior del cerrojo con la marca del lápiz.

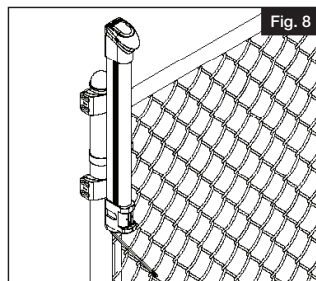

- 6.** Mientras sostiene el cerrojo a la altura correcta (utilice la marca inferior), marque los agujeros del soporte inferior, taladre e instale dos tornillos G #10 de 11/4" (Fig. 9).

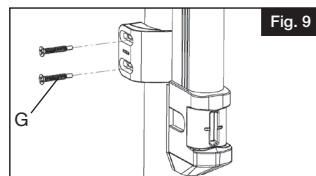

- 7.** Coloque el soporte superior a 1/4" de la tapa del poste. Marque los agujeros, taladre e instale dos tornillos G #10 de 11/4" (Fig. 10).

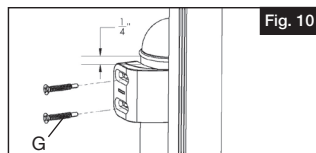

- 8.** Destornille el tornillo de ajuste y retire el cerrojo de la piscina (Fig. 11).

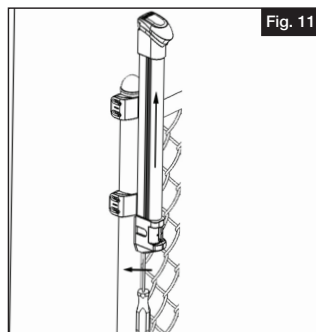

- 9.** Taladre e instale cuatro tornillos G #10 de 11/4" (Fig. 12).

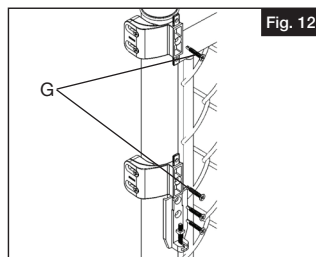

- 10.** Vuelva a colocar el cerrojo de la piscina y atornille el tornillo de ajuste hasta que la parte inferior del soporte de montaje F quede a ras con la parte inferior del cerrojo (Fig. 13).

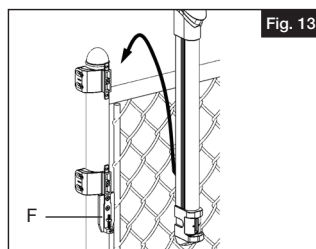

- 11.** Tomando la traba del kit de cerrojo de la piscina, retire los cuatro tornillos pequeños que sostienen la cubierta en su lugar y luego retire la cubierta. A continuación, desatornille el tornillo de ajuste que sujeta el soporte de montaje y retire el soporte de montaje (Fig. 14).

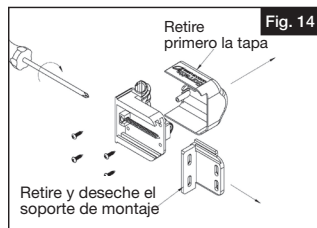

- 12.** Instale el soporte de montaje del poste redondo A y gire el tornillo de ajuste hacia la derecha hasta que el soporte quede encajado, tal como se ilustra (Fig. 15). A continuación, vuelva a colocar la tapa en la posición anterior y vuelva a colocar los cuatro tornillos pequeños.

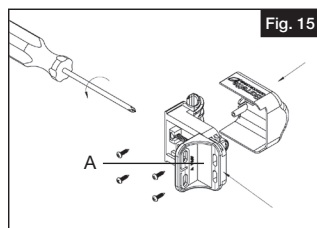

- 13.** Determine el tamaño del montante de portón. Si es de 15/8", solo use el soporte de portón (A) (Fig. 16). Si es de 13/8", use el adaptador (B) con el soporte de portón (A) (Fig. 17).

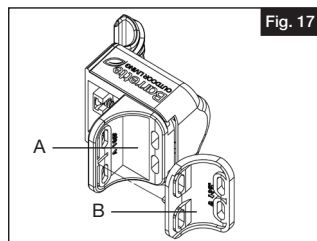
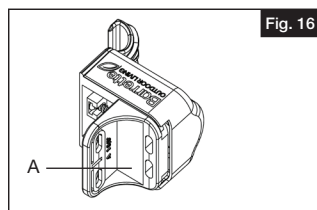

- 14.** Coloque el conjunto de la traba en el montante de portón y alinee las marcas verticales de alineación. Luego, con un lápiz haga una pequeña marca en el montante de portón, justo encima y a un lado del conjunto de la traba (Fig. 18).

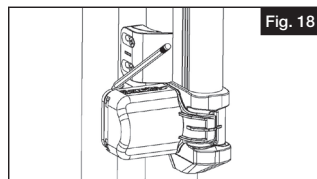

- 15.** Suelte el conjunto de la traba del conjunto del cerrojo levantando la tapa de liberación del cerrojo (Fig. 19).

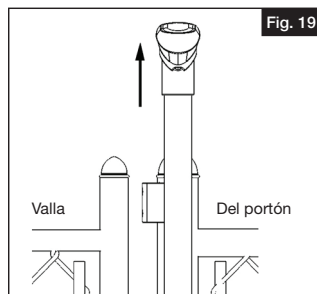

16. Abra el portón y reposicione el conjunto de la traba en el montante del portón, si se movió de lugar, donde marcó previamente e instale los tornillos H #10 de 1" (Fig. 20).

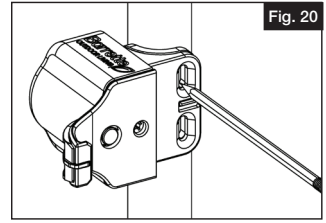

17. Taladre e instale los tornillos laterales en el soporte de la traba (Fig. 21).

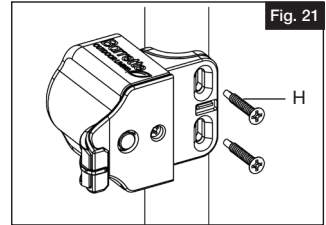

18. Exponga otros agujeros de montaje ajustando el conjunto de la traba hacia afuera del portón con un desarmador (Fig. 22).

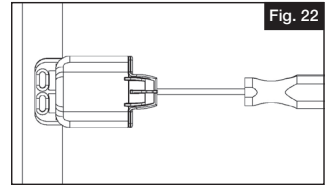

19. Instale dos tornillos H #10 de 1" (Fig. 23).

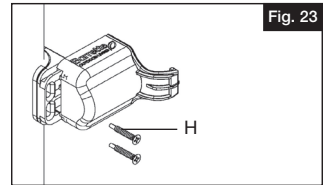

20. Ajuste el tornillo de ajuste del cerrojo (Fig. 24) hasta que el cerrojo y la traba se alineen como se ilustra en la (Fig 25).

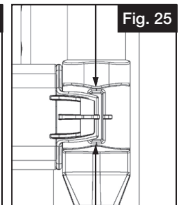
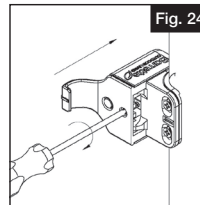

21. Sostenga el portón cerca del conjunto del cerrojo y ajuste el tornillo de ajuste vertical debajo del conjunto del cerrojo y/o el tornillo de ajuste horizontal en el conjunto de la traba hasta que la alineación se vea como en la (Fig. 26).

NOTA:

Este cerrojo no funcionará correctamente si el conjunto de cerrojo y traba no están alineados como se muestra en la ilustración.

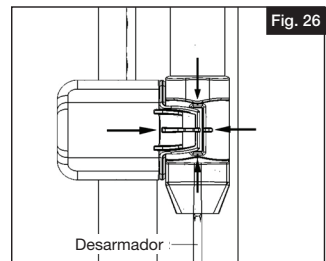



Barrette Outdoor Living
7830 Freeway Circle, Cleveland, OH. 44130
barretteoutdoorliving.com • (877) 265-2220