



MAIN FUNCTIONS

- 3 function buttons: HOLD/CAL, IR, ON/OFF
- Temperature measurement range:
Probe -50°C to +300°C, -58°F to +572°F
IR 0°C to +500°C, 32°F to +932°F
- Default temperature setting: °F
- Measurement period: 2 to 3 seconds
- Temperature Resolution: + or - 2°F
- Low Power Display: When the battery is low, the **LOW** symbol will be displayed.
- Auto Sleep Mode: 90 seconds auto shut-off
- Backlight: Each time a key is pressed, after 5 seconds, the LED backlight will dim for 4 seconds, then shutoff.
- The  symbol indicates the IR temperature is being shown, the  symbol indicates the Probe temperature is being shown

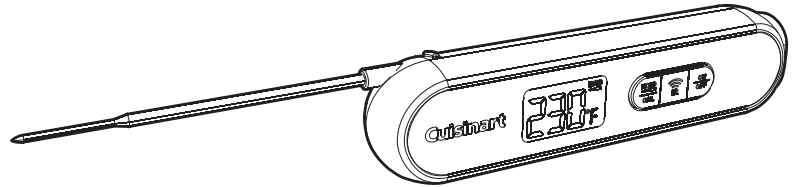

IMPORTANT SAFETY INFORMATION

WARNING:

- Be careful when laser beam is turned on.
- Do not let the beam enter your eye, another persons eye or the eye of an animal.
- Be careful not to point the beam on a reflective surface in case of reflecting the beam to eyes.
- Do not allow the laser light beam impinge on any gas or area which can explode.
- Always use a heat-resistant glove when handling meat probe. **DO NOT** touch with bare hands.
- The temperature probes are meant to be used only for measuring meat temperatures and will get damaged if exposed to temperatures hotter than 572°F.
- The temperature probe is sharp, use caution to avoid injury when using.
- Keep away from children.







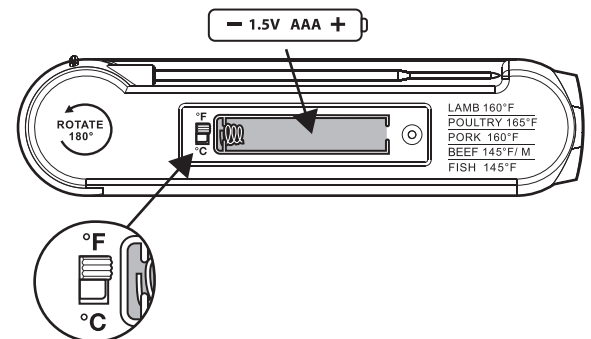

START AND RESET

- Peel off protective film before using. Using Phillips head screwdriver, loosen screw and carefully pull it for easy removal of the battery compartment cover from back. **NOTE:** Do not pull on clip to remove cover.
- Place one AAA battery (not included) in battery compartment, place battery cover back and secure with screw.
- The thermometer default temperature setting is Fahrenheit, to use Celsius, before closing the battery cover, locate the switch next to the batter holder and switch to change setting to Celcius.
- Power the thermometer on after the batteries are installed, all functions will show on the display for 1 second and it will start to measure the environment's temperature. Also, after 5 seconds, the LED backlight will dim for 4 seconds, then shutoff.



INSTRUCTIONS

1. Press the  button to turn on the thermometer, the display will show all of it's symbols for 1 second and then display current ambient temperature (sensed by the tip of the thermometer's probe).
2. Press the  button to hold the current reading on the display, the symbol "HOLD" will appear on the display.
3. Press the  button to use the IR mode, point the laser directly on the surface to read its temperature. The temperature will remain on the display and the symbol "HOLD" will appear on the display.

4. To calibrate the temperature, take a cup of ice-water, insert the probe into the ice-water halfway, touching the probe to an ice cube (make sure the probe is under water). Once the temperature settles, hold the  button for 3 seconds to get into calibration mode. 0°C or 32°F will flash for 1 second after the calibration is finished, press the  button to confirm, then press the  to exit the calibration mode. Thermometers should be calibrated regularly to make sure readings are accurate.

5. To turn off the thermometer, hold the  button for 3 seconds.

USE AND CARE

1. For best results, make sure probe tip is inserted into the thickest part of the meat at least 1 inch.
2. When inserting the probe into meat, avoid fatty part and bones.
3. Do not allow the probe to come in direct contact with flames.
4. Make sure that probe tip is inserted into the center of meat (NOT poking through meat).

Hand wash the meat probe **ONLY** using mild soap and hot water. Rinse thoroughly. Dry completely with a soft cloth. Spot clean body of thermometer.

IMPORTANT: Do not leave outside over night or through inclement weather. Never submerge. Thermometer is water resistant, not waterproof.

DO NOT touch hot probe or wire with bare hands during or just after cooking. Always wear a heat resistant glove.

DO NOT RETURN PRODUCT TO THE STORE

Before visiting your local retailer, please email grilling@thefulhamgroup.com, call 1-866-994-6390, or visit www.thefulhamgroup.com to online chat with a representative. To best serve you, our Representatives are available to answer your calls and live chats Monday to Friday, 9 AM - 5 PM EST.

Get Social With Us @CuisinartBBQ    YouTube

See our full line of premium Cuisinart® Outdoor Cooking Products at www.cuisinart.com/outdoorgrilling

©2021 Cuisinart
Cuisinart® is a registered trademark under license to The Fulham Group.
Distributed by The Fulham Group, Newton, MA. 02466 U.S.A. MADE IN CHINA.
One Year Limited Warranty.

Model # CSG-200
North American Distributor:
The Fulham Group
Newton, MA 02466

Cuisinart
SAVOR THE GOOD LIFE