

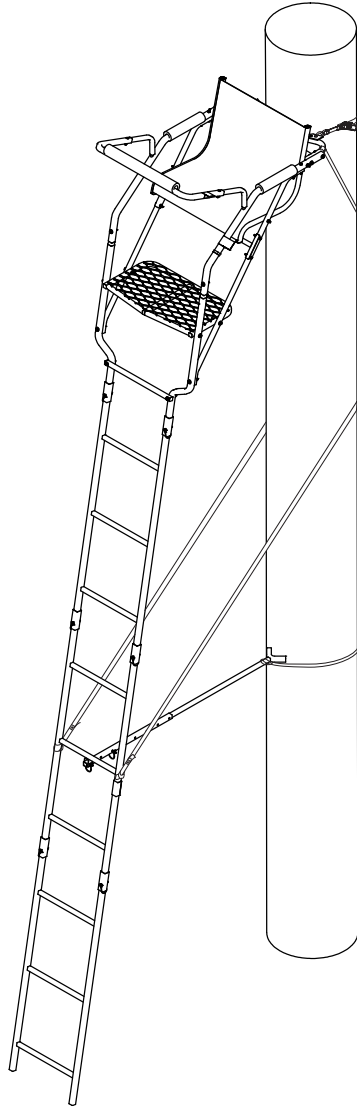

WE ARE HUNTERS



Operator's Manual

RELAX WIDE™ Ladder Stand

MODEL RE664

Maximum Height

16' 9" to shooting rail

Maximum Field Rating

300 lbs

Tree Diameter Range

12" to 20"

Wear Your Harness!



ATTENTION

**YOU MUST READ ALL WRITTEN INSTRUCTIONS
AND WATCH THIS SAFETY VIDEO BEFORE USING!**



WATCH THIS SAFETY VIDEO BEFORE USING!

Scan →



or Visit →

www.standsafety.com/r3

Scan the QR code with your smart phone, tablet or similar device.

OR

Type the website address into your web browser to view an important safety video before using this product.

LADDER STAND SAFETY

PRODUCT MEETS
INDUSTRY STANDARDS
RECOGNIZED BY



PARTICIPATING MEMBER

Get parts online at
www.HuntRiversEdge.com

© 2022 RETI
All Rights Reserved

P/N: 31975
C/N: 31992
REV4: 01/31/22

INTRODUCTION

Rivers Edge® Treestands are engineered with you the hunter in mind. We appreciate your purchase of one of our world class treestands. Follow these few simple instructions and your stand will provide you many years of trouble-free pleasure. Instructions should be kept in a safe place and reviewed at least annually.

If for any reason you have a problem with your product, **DO NOT return to the retailer**, contact the Rivers Edge® customer service department at 800-345-6007 for assistance.

CONTENTS

Introduction/Warranty	2
Warnings.....	3-4
Inspection and Maintenance	4
Hardware Identification Chart.....	5
Tools Needed	5
Assembly Instructions	7-11
Warnings.....	12
Setup and Use Instructions.....	13-14
Finished Ladder.....	15
Illustrated Parts Breakdown.....	16-17

WARRANTY

RETI offers a **one year warranty** for all components of the treestand. These warranties apply to the original owner with a proof of purchase. These warranties begin on the date of purchase by the first retail consumer and continue for the period specified above. These warranties apply to products that are not modified, abused or used in a manner that deviates from the product's intended usage. Minor fading in color is normal and is not covered by warranty. Any corrosion of painted surfaces that occurs as a result of paint being removed or damaged is also not covered by warranty. RETI offers no other warranty expressed or implied. Products for which warranty work has been approved must be sent directly to RETI and performed by RETI. **To obtain warranty service and/or replacement instructions, you must obtain prior approval from RETI before shipping your package to us by calling our customer service department at 800-345-6007 or by writing to: RETI, P.O. Box 755, 1730 Industrial Avenue, Cumberland, WI 54829 for a return material authorization number (RMA#).** All items must be shipped prepaid. RETI will, at no charge, repair or replace, in RETI's sole discretion, any product that satisfies the conditions stated above. RETI retains the right to change models, specifications and price without notice.

This equipment has been manufactured under strict quality and safety guidelines. As with any equipment of this type, full understanding of the instructions and its use is mandatory and imperative for the safety of its user. RETI is not responsible for any damages or injuries sustained due to improper use or modification of any of its products, or resulting from any use which deviates from the product's intended usage. RETI is not responsible for any injuries sustained due to failure to read and adhere to the instructions for use. Any misunderstanding or questions regarding the products of their use should be directed to RETI prior to any use. **All RETI treestands are sold with a full body harness ("Fall Arrest System") that meets standards set by the Treestand Manufacturer's Association ("TMA").** It is the owner's sole responsibility to inspect the product regularly for damage, improper installation, or conditions that could jeopardize the ultimate safety of the product. Failure to use or improper use of the provided Fall Arrest System may result in serious injury or death. **ALWAYS wear the provided Fall Arrest System while using this product. Owner is responsible to understand and follow product field weight rating and must never exceed maximum weight rating.** RETI is not responsible for any malfunction or injury resulting from normal wear and tear, damage caused by improper use, improper maintenance, negligence or accidents. This product, if used safely as intended, will provide trouble free service for the useful life of the product. We hope you will enjoy the quality of our products for years to come, and have a safe hunt.

STOP

READ AND UNDERSTAND THE FOLLOWING WARNINGS BEFORE ASSEMBLY

MODEL RE664

MAXIMUM USE HEIGHT - 16' 9" TO SHOOTING RAIL

MAXIMUM OCCUPANCY - ONE (1) PERSON

TOTAL WEIGHT LIMIT - 300 LB

TREE DIAMETER RANGE - 12" TO 20"

WARNING

- ▲ This product carries strict height and weight restrictions. **Do Not** use this product if you exceed the total weight limit. Please note that the total weight limit includes the user(s) and their equipment.

WARNING

- ▲ **When hunting from a treestand falls can occur any time after leaving the ground causing injury or death.**
- ▲ **Always** wear a Fall Arrest System (FAS) comprising a full body harness at all times after leaving the ground. You must stay connected at all times after leaving the ground while using climbing and hang-on treestands. Single safety belts and chest harnesses are no longer allowed and shall never be used. If you are not wearing a full body harness properly attached to the tree that is protecting you from a fall, do not leave the ground.
- ▲ **Read and understand** all of the manufacturer's Warnings and Instructions and use all safety devices provided by the manufacturer. Contact the manufacturer for any questions. Failure to do so could result in injury or death.
- ▲ **Never** exceed the total weight limit of the treestand.
- ▲ **Never** use a treestand during inclement weather such as rain, lightning, windstorms or icy conditions and end your hunt and return to the ground if inclement conditions arise.
- ▲ **Never** use a treestand while using drugs (even prescription drugs) or alcohol.
- ▲ **Never** use a treestand while feeling ill, nauseous or dizzy, or if you have a prior medical condition that could cause a problem, that is, heart condition, joints that lock-up, spinal fusions, etc., or if you are not well rested. **Never** sleep in stand.
- ▲ **Never** use a treestand on a dead, leaning, diseased or loose barked tree, or a utility pole. **Always** avoid electrical power lines.
- ▲ **Never** rely on a tree branch for support.

WARNING

- ▲ **Never** jump or bounce on a treestand to seat it to the tree.
- ▲ Pull up a bow, backpack, or firearm or other equipment only after being secure in the treestand and a firearm must be pulled up with it unloaded, chamber open, and muzzle down.
- ▲ **Always** inform someone of the hunting location, where the treestand will be located and the expected duration of the hunt.
- ▲ A signal device such as a mobile phone, radio, whistle, signal flare or personal locator device (PLD) must be on your person and readily available at all times.
- ▲ Inspect the treestand and all safety devices each time before use and **Do Not** store a treestand outdoors when not in use.
- ▲ **Never** modify your treestand in any way by making repairs, replacing parts, or altering it except if explicitly authorized in writing by the manufacturer.
- ▲ Practice installing, adjusting and using your treestand at ground level prior to using it at elevated positions. Study your new stand to become familiar with all of its features and design. Doing so will confirm that the product is manufactured, assembled and installed correctly.
- ▲ Instructions (written and video) shall be kept in a safe place and reviewed at least annually. It is the responsibility of the treestand owner to furnish the complete instructions to any person who borrows or purchases the treestand.
- ▲ Use at least three (3) people to install or take down a ladder treestand.
- ▲ The criss-cross straps/ropes and stabilization devices must be attached before climbing to the platform.
- ▲ When installing a ladder stand, always bounce on the first rung to set the ladder into the ground according to manufacturer's instructions before proceeding to climb any higher.
- ▲ Check every ladder section connection every time you use the stand before you leave the ground. If ladder sections are separating, do not use the stand.
- ▲ Check the ground under the stand to make sure it is firm and level. Sloping ground or uneven surface (one side on a rock) can cause your ladder to tilt or shift off the tree as you climb.
- ▲ **Always** maintain three (3) points of contact when climbing a ladder treestand. Proper three-point contact means having either two feet with one hand or one foot with two hands on the step portion of the ladder or climbing aid at all times.

WARNING

- ▲ **Always** lean forward as you climb and attach your harness to the tree before securing the platform to the tree and stepping onto the platform.
- ▲ **Never** exceed the stated maximum use height.
- ▲ **Do Not** use this product until you have watched the safety video, understand it, and practiced the techniques for safe hunting discussed in this video. The video can be found with the QR code and/or URL shown on front cover of this manual.
- ▲ Read and perform all inspection and maintenance tasks before each and every use. Replace any questionable components immediately with RETI original replacement parts.
- ▲ **Do Not** crush tubing when tightening bolt assemblies! Identify and familiarize yourself with all parts before you start. Bolt identification chart can be found on the following page of the manual.
- ▲ Double check assembly steps to be certain you have correctly assembled this product.
- ▲ **Never** use any product that has not been maintained or inspected properly - Your life depends on it!
- ▲ Replace any and all treestand straps every two years or when any signs of damage or wear exist before.
- ▲ **Always** wear the appropriate footwear when using a ladder treestand. A good non-slip safety boot is important to your personal safety. Be especially careful that boot laces do not get hooked on the stand or any of its components (tuck shoelaces into boots before climbing).

WARNING

- ▲ **Only** use approved RETI parts. Failure to do so may result in serious injury or death!

INSPECTION AND MAINTENANCE

BEFORE EACH USE PERFORM THE FOLLOWING:

- Inspect all webbing, rope, cord, and strap assemblies for wear or damage.
- Inspect cables and/or cable ends for damage or kinking.
- Inspect all hardware and chain components for damage or wear.
- Inspect for any structural damage to product. (If any exists stop use immediately and call RETI Customer Service.)
- Inspect all nut and bolt assemblies to be certain none are loose.
- Inspect for any missing parts.
- Lubricate all pivot and slide together points with powder graphite, petroleum jelly or silicone spray to prevent noise, wear and rust.
- Inspect entire product for any rust, corrosion, cracks, freezing, excessive heat or rotting damage that may effect the safety of your product. Discard any questionable product.
- Inspect entire product for any structural damage - pay close attention to all weld locations. (Discard product if any damage is found.)
- Using correct wrenches inspect all nut & bolt assembly locations and snug up any that may be loose. Be careful not to crush tubing when tightening!
- Inspect and check operation of all cables, cable ends, cord, rope, webbing, and strap or chain assemblies. Replace with RETI original replacement parts any item or assembly that shows signs of wear, damage, kinking, or functions incorrectly.
- Inspect seat for damage or wear. Replace any seat with factory new that shows signs of structural damage or wear.
- Never modify your stand in any way by making repairs, replacing parts, or altering by adding or attaching anything to it except if explicitly authorized in writing by the manufacturer.

HARDWARE IDENTIFICATION CHART

Bolts shown are for size reference.
Extra hardware may be included in the parts bag.

Quick Tip: Cut page out to use as a reference tool while following assembly instructions

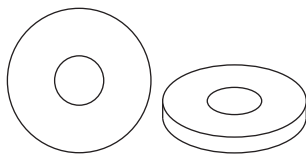
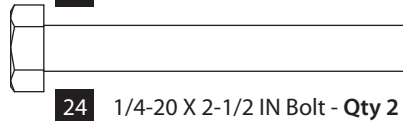
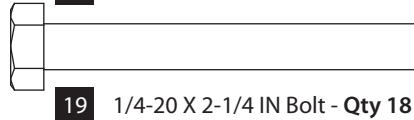
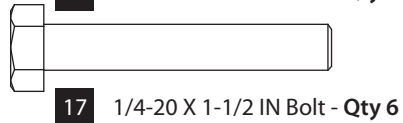
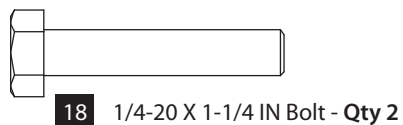

21

M6 Yellow Washer
Qty 12

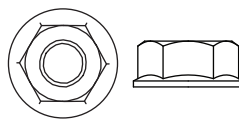

22

1/4-20 Nut
Qty 28

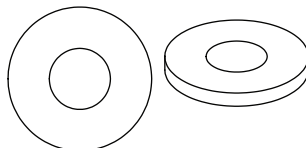

20

1/4 IN Washer
Qty 6

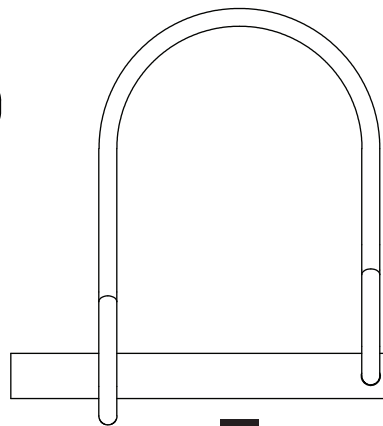

23

Lockpin
Qty 8

TOOLS FOR ASSEMBLY (NOT TO SCALE)



2 - 7/16" Wrenches

ASSEMBLY INSTRUCTIONS

IMPORTANT ASSEMBLY TIP:

Do not tighten any nut and bolt combinations completely until all parts are assembled together! Finger tighten plus one turn of a wrench only! This will temporarily hold the locknut on the bolt while helping alignment of all parts! After all parts are assembled together, all nut and bolt combinations must be completely tightened.

All assembly must be done in this order at ground level before uprighting.

Do not remove labels/warnings from product, they are there for your safety.

Recommended for adult use only.

FIGURE 1

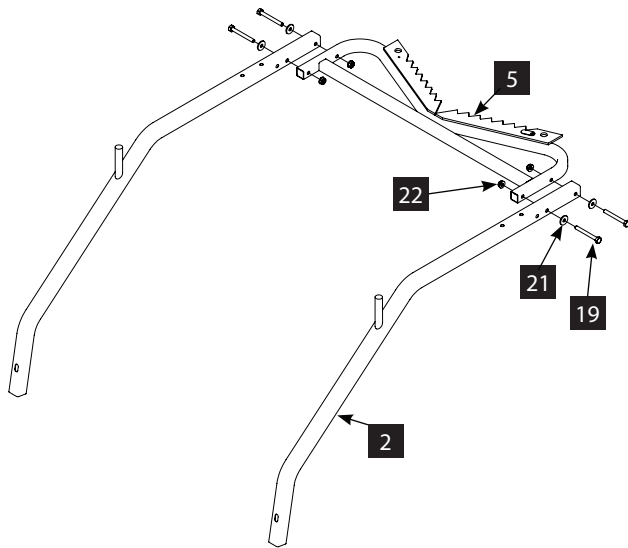

NOTE: When selecting a tree to install the treestand in, never use a treestand on a dead, leaning, diseased or loose barked tree, or a utility pole. Always avoid electrical power lines.

1. Attach the tree blade (5) to the main ladder side rails (2) using four 1/4-20 x 2-1/4 IN bolts (19), locknuts (22) and yellow nylon washers (21). **Do not tighten all nut and bolt assemblies completely! SEE FIGURE 1.**

2. Insert the crimped end of two flared rails (6) into the main side rails (2). Secure using two provided 1/4-20 x 1-1/2 IN bolts (17), locknuts (22) and yellow nylon washers (21). Pay special attention to orientation of flared rails. **SEE FIGURE 2.**
3. Attach the foot platform (4) to the inside of flared rails (6) using two 1/4-20 x 2-1/4 IN bolts (19), locknuts (22) and yellow nylon washers (21). **SEE FIGURE 2.**

NOTE: Mesh surface of foot platform should be on top.

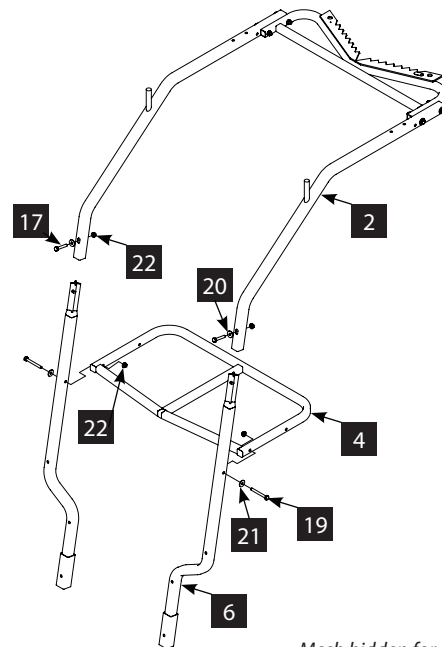

Mesh hidden for clarity

FIGURE 2

FIGURE 3

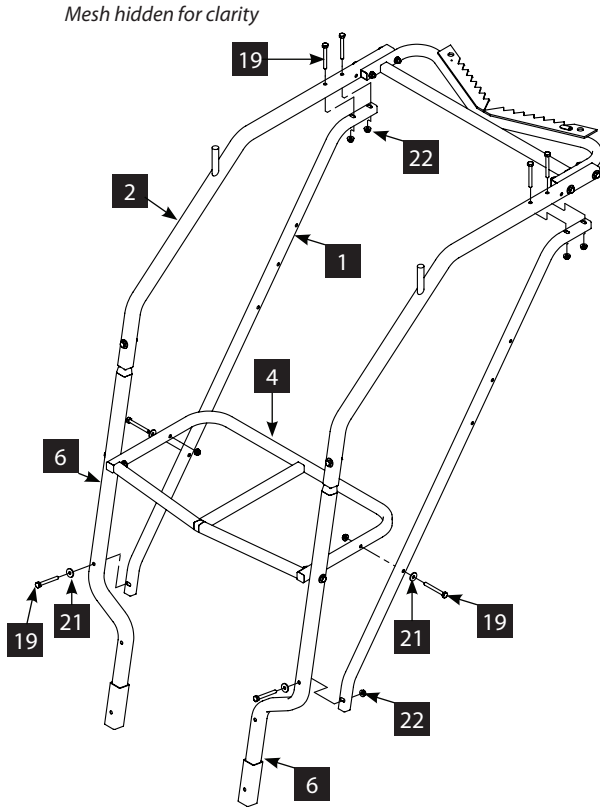

4. Attach the ends with two holes of the upper ladder support tubes (1) to the bottom side of main side rails (2) using four 1/4-20 x 2-1/4 IN bolts (19) and locknuts (22). **SEE FIGURE 3.**
5. Attach the opposite ends of upper ladder support tubes (1) to the backside of flared rails (6) using two 1/4-20 x 2-1/4 IN bolts (19), locknuts (22) and yellow nylon washers (21). **SEE FIGURE 3.**
6. Attach the foot platform (4) to the upper ladder support tubes (1) using two 1/4-20 x 2-1/4 IN bolts (19), locknuts (22) and yellow nylon washers (21). **SEE FIGURE 3.**

7. Attach the cross support (7) to the upper ladder support tubes (1) using four 1/4-20 x 1-1/2 IN bolts (17) and locknuts (22). **SEE FIGURE 4.**
8. Attach the ladder step (13) to the front side of flared rails (6) using two 1/4-20 x 2-1/4 IN bolts (19), locknuts (22) and steel washers (20). **SEE FIGURE 4.**

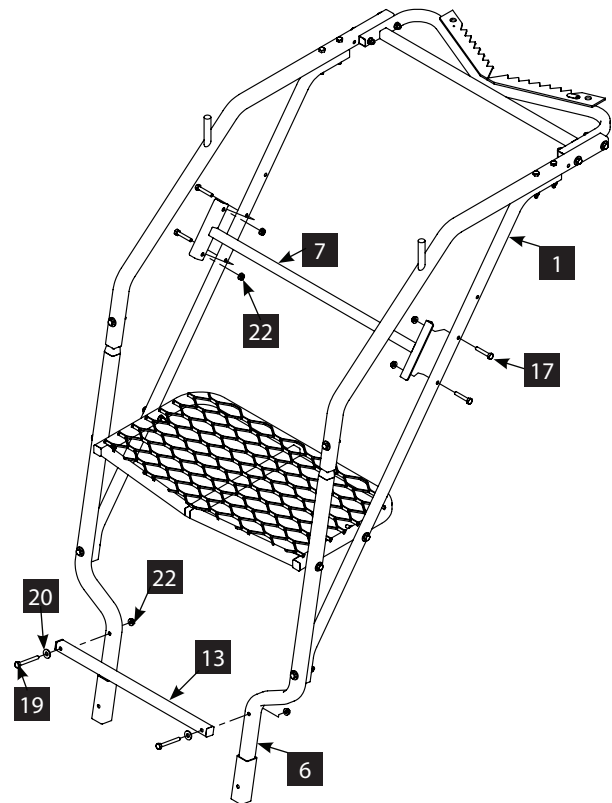
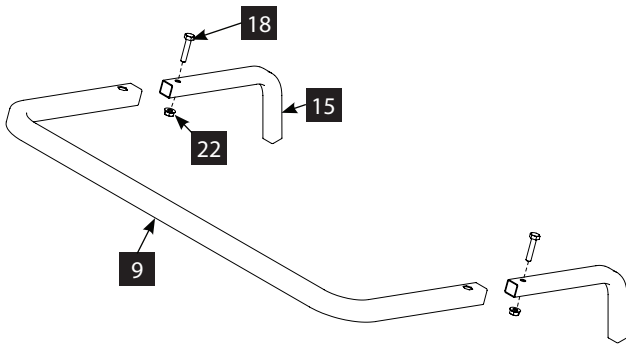

FIGURE 4

FIGURE 5



9. Insert the shooting rail J-pipes (15) into the shooting rail rim (9). Secure together using two 1/4-20 x 1-1/4 IN bolts (18) and locknuts (22). You must now tighten all nut and bolts of the upper ladder stand assembly. Be sure not to over tighten or crush tubing when tightening! **SEE FIGURE 5.**

10. Attach the factory assembled mesh seat with seat rails (8) to the previously assembled upper ladder stand assembly.
11. Using two 1/4-20 x 2-1/2 IN bolts (24), locknuts (22) and steel washers (20), attach upper portion of each seat rail to the main side rails (2). **SEE FIGURE 6.** It is important to have the bolt head on the seat rail side and the locknut on the main side rail side. Finger tighten these two bolts only at this time.
12. Using two 1/4-20 x 2-1/4 IN bolts (19), locknuts (22) and steel washers (20), attach the lower portion of each seat rail to the upper ladder support tubes (1). **SEE FIGURE 6.** It is important to have the bolt head on the seat rail side and the locknut on the upper ladder support tube side for ease of assembly.
13. Alternately tighten all four nut/bolt assemblies from steps 11 and 12. The spanned mesh seat will become tighter as you tighten each nut/bolt assembly. Tighten until all steel tubular components are tight to each other, locking feature of nuts are fully engaged by bolt threads and spanned mesh seat is taut. Be sure not to overtighten or crush tubing when tightening!

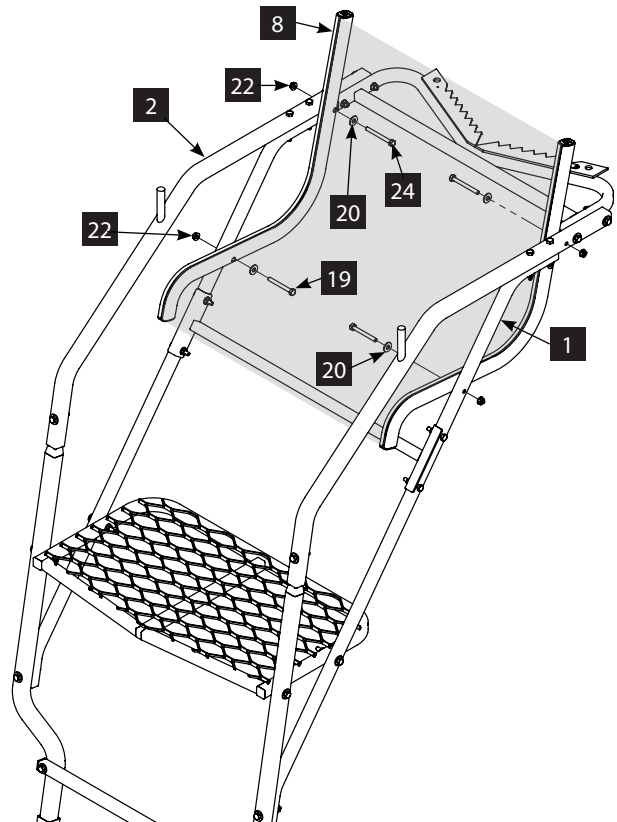
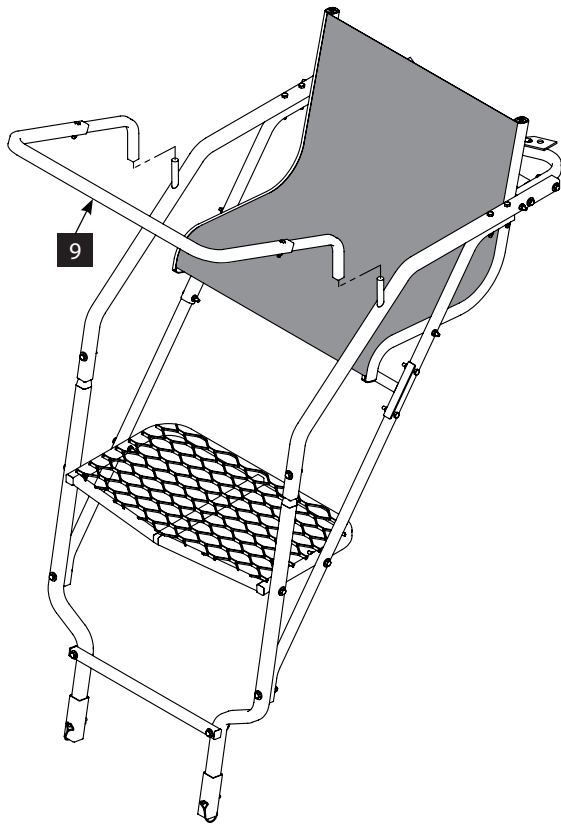

FIGURE 6

FIGURE 7



14. Attach the removable shooting rail by sliding it onto the posts. **SEE FIGURE 7.** Lubrication is recommended to prevent binding and noise.
15. Attach the two provided 9 IN armrest pads (28) and one 18 IN shooting rail pad (29) by wrapping around tubing and attaching hook and loop attachment strips together.

16. Sections are assembled on the ground in the following order; bottom section (16); middle ladder section with stabilizer slot (11); top section (10); assembled top platform section. **SEE FIGURE 8.**
17. With all sections assembled together on ground, secure all sections together using six provided spring lock pins (23). The handles of the spring lock pins must be put to the outside of ladder side rails. **SEE FIGURE 8.**

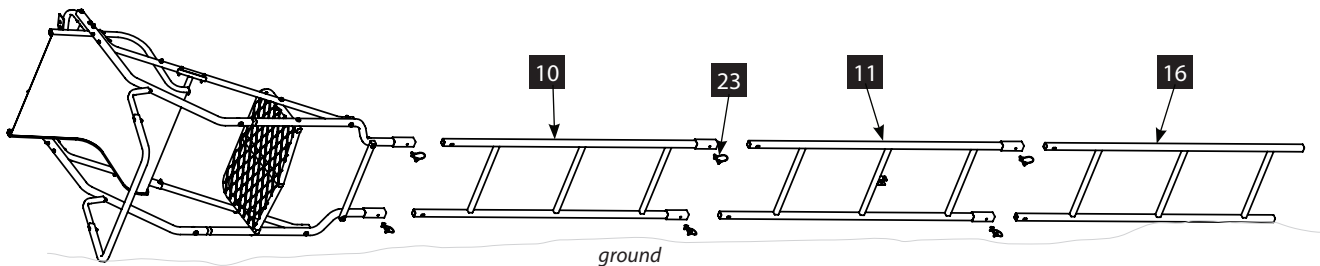
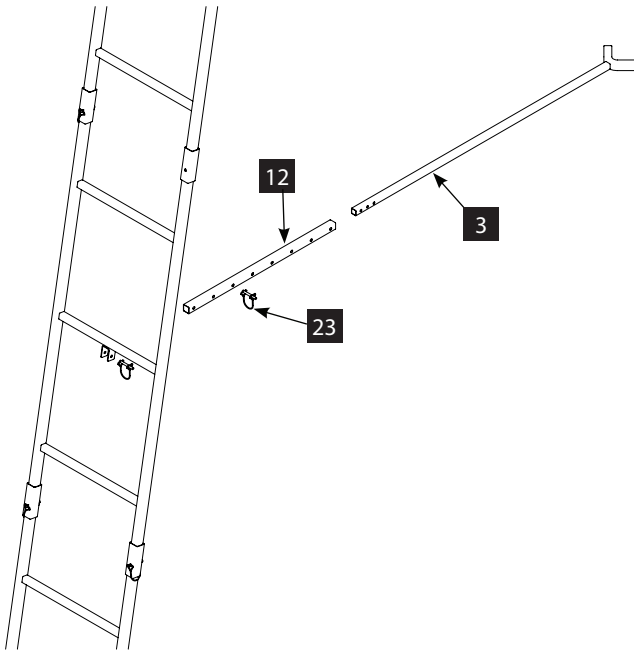

FIGURE 8

FIGURE 9



18. Attach the stabilizer bar extension tube (12) to the second ladder section mounting bracket using one provided spring lock pin (23). **SEE FIGURE 9.**
19. Slide the stabilizer bar (3) into the extension tube (12) and attach the two pieces together using one provided spring lock pin (23). Spring lock pin must go through both the extension tube and stabilizer bar at appropriate hole to achieve desired distance from tree. Adjustment in length may be needed when ladder is uprighted later in the Setup and Use Instructions. **SEE FIGURE 9.**

NOTE: Treestand should ALWAYS be fully assembled on the ground prior to mounting it in the tree.

20. Attach the two long ends of the 16' criss-cross straps (26) to the tree blade (5). These long stabilizer straps should be attached by pulling the free end of the strap through the loop end of the strap to create a cinch knot around the frame tube. **SEE FIGURE 10A AND 10B.**

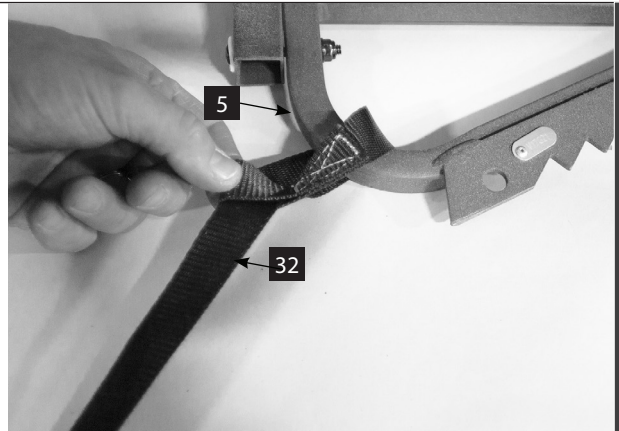

FIGURE 10A

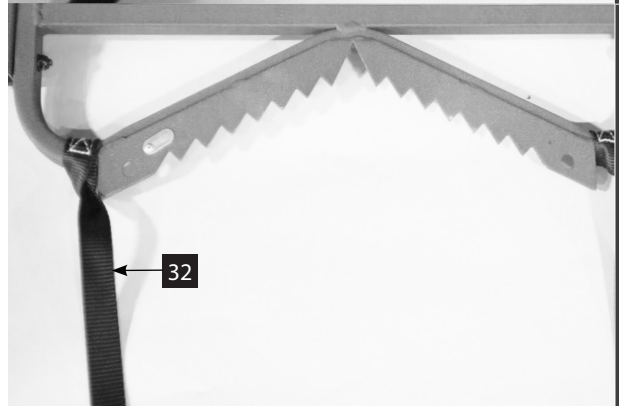

FIGURE 10B

FIGURE 10

STOP

READ AND UNDERSTAND THE FOLLOWING WARNINGS BEFORE SETUP AND USE

! WARNING

- ▲ Double check assembly steps to be certain you have correctly assembled this product.
- ▲ Study your new stand to become familiar with all of its features and design. At ground level, following provided use instructions, practice attaching stand to tree and removing stand from tree. Practice sitting, standing, and using this product before attaching overhead. Save these instructions for future reference. You must always use the provided Fall Arrest System (FAS) while using this product.
- ▲ **Always** use at least three (3) people to install or take down a ladder treestand. **Always** have two people stabilize the ladder before climbing to the platform the first time after every set-up.
- ▲ Be absolutely sure the tree blade(s) on stand and the stabilizer bar are contacting tree before climbing ladder.
- ▲ Stabilizer bar must always be correctly and securely attached to ladder and tree before climbing ladder.
- ▲ Make sure ladder bottom is firmly seated on dry, level ground. Attach your harness tether to the tree before securing the platform to the tree and stepping onto platform. Refer to the Full Body Harness instructions.
- ▲ **Never** ascend or descend ladder without criss-cross straps/ropes securely holding ladder to tree and stabilizer bar securely attached. Failure to correctly perform these steps can cause the ladder to collapse/buckle-over backwards during the initial ascent to attach ratchet strap resulting in serious injury or death.
- ▲ **Always** lean forward as you climb and attach your harness to the tree before securing the platform to the tree and stepping onto the platform.

! WARNING

- ▲ Bring ratchet strap(s) up with you in a pocket - **Do Not** carry in your hands!

! WARNING

- ▲ **Always** maintain three (3) points of contact when climbing a ladder treestand. Proper three-point contact means having either two feet with one hand or one foot with two hands on the step portion of the ladder or climbing aid at all times.
- ▲ **Always** wear the appropriate footwear when using a ladder treestand. A good non-slip safety boot is important to your personal safety. Be especially careful that boot laces do not get hooked on the stand or any of its components (tuck shoelaces into boots before climbing).
- ▲ **Never** stand on seat, it is designed for sitting only.
- ▲ **Do Not** allow excessive strap buildup in ratchet as this will prevent the ratchet teeth from engaging causing slippage.
- ▲ **Always** attach ratchet straps securely while using this product!
- ▲ If seat is removable, be certain it is securely attached when in use.
- ▲ Some models include a shooting rail. **Never** lean against, lean over, or sit on shooting rail. It is designed as a shooting rest only. **Always** be aware that the shooting rail can swing to one side or pivot up and down.
- ▲ Some models include a footrest, which is designed as a footrest only. **Never** stand on footrest! **Always** be fully aware of foot placement.
- ▲ Some models include a multi-piece stabilizer bar system. Be sure attachment hardware goes through both the extension tube and the stabilizer bar.

SETUP AND USE INSTRUCTIONS

WARNING

- ▲ **Never** use a treestand on a dead, leaning, diseased or loose barked tree, or a utility pole. **Always** avoid electrical power lines.
- ▲ Bring ratchet strap(s) up with you in a pocket - **Do Not** carry in your hands!

During installation and removal of ladder treestands, you must always and properly use the included Full Body Harness (Fall Arrest System). Refer to the Full Body Harness instructions included with this product for proper use.

1. Select a straight, healthy tree. Do not attempt to install on a tree that is not healthy.
2. With assembled product lying on the ground, **position one person at bottom end of ladder lying on the ground.** This person has to prevent the ladder end from tilting up when platform end is lifted and prevent the ladder from skidding across ground.
3.
 - a. Position two people at the platform end of the ladder, lift the platform end and continue uprighting by walking toward bottom end of ladder and moving hands along ladder legs. **Stand ladder up against chosen straight tree on dry, level ground.** Use caution when ladder comes over center against the tree. **SEE FIGURE 11A.**
 - b. Step back and look at the ladder top to see that it is level. Adjust as needed to achieve a level platform top. Make sure tree blade is contacting tree. **SEE FIGURE 11B.**
 - c. Step down hard on bottom step to push ladder legs into the ground. **SEE FIGURE 11C.**
4. While two people hold the stand in place, the third person should connect the horizontal stabilizer bar to the tree. Adjust the length of the stabilizer bar as need so it contacts the tree and is level to the ground. Then secure it to the tree with the 6' cam strap (31) by forming a cinch knot with both ends of the strap and running the long end of the strap through the cam buckle. **SEE FIGURES 12 AND 13.**

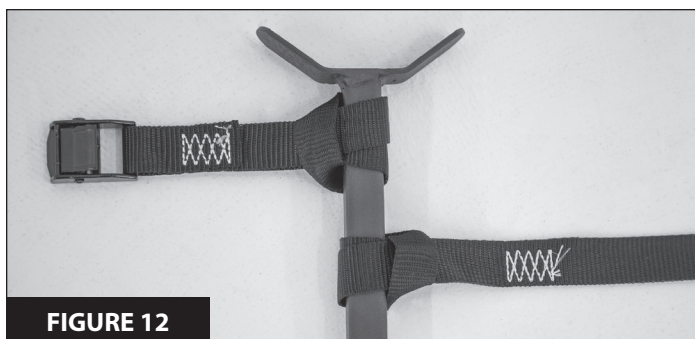

FIGURE 12

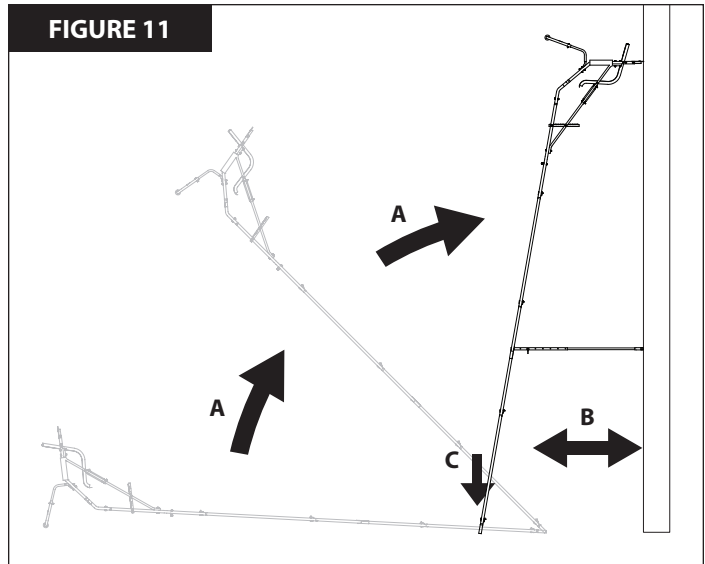

FIGURE 11



FIGURE 13

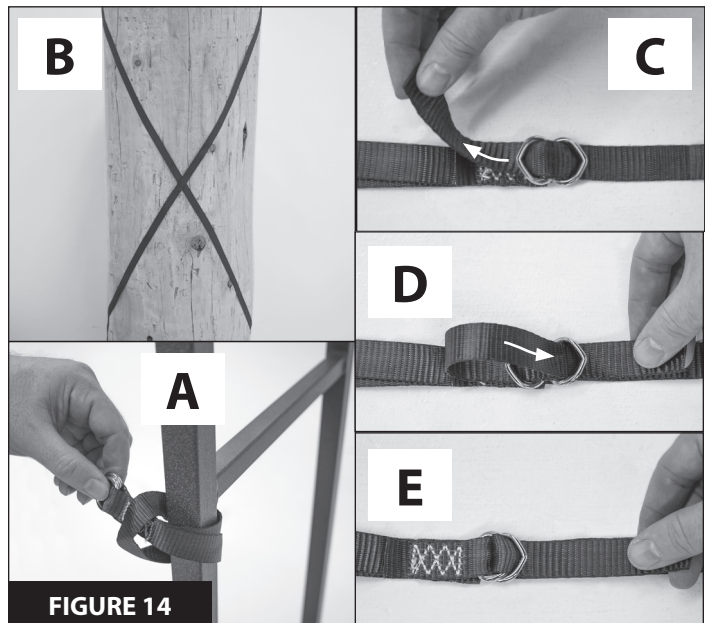

FIGURE 14

5. a. Loop the D-loop end of the two 16' criss cross straps (26) through the loop end to form a cinch knot around the ladder rail tube. Secure beneath a step rung, at the stabilizer bar height location. **SEE FIGURE 14A.**
 b. With the stand level and being held in place by two people, the third person must cross one of the 16' criss cross straps (26) behind the tree and feed the free end through the opposite D-loop. **SEE FIGURE 14B-E.**
 c. Criss cross the other 16' stabilizer strap (26), forming an "X" pattern on the of the tree and feed the free end through the opposite D-loop. **SEE FIGURE 14B-E.**
6. Make sure the criss cross straps and stabilizer bar strap are snug and the tree blade is still contacting the tree.

NOTE: This ground level ladder-to-tree attachment will prevent the ladder from pulling away from the tree while ascending to the top for final 6' ratchet strap (27) attachment. The same holds true when the ladder is removed.

7. **With two people securely holding the ladder,** use the three point contact climbing method to slowly climb the ladder and carefully keep a constant hand grip on the ladder at all times. Always lean forward, toward tree, to keep top section tree blades against the tree. **Be certain ladder bottom is firmly seated on dry, level ground. Attach your harness tether to the tree before securing the platform to the tree and stepping onto platform. Refer to the Full Body Harness instructions included with this product.**

NOTE: Bring ratchet strap up with you in a pocket. DO NOT carry in your hand!

8. a. Standing on ladder step, lean toward tree with ratchet strap now in hand, Hook "S" hook with long strap through hole provided on tree blade. Feed the long strap through the center (slot) of ratcheting mechanism and back around through tightening lever. **SEE FIGURES 15, 16A AND 16B.**

NOTE: Be sure you feed the long strap correctly so there are no twists in the strap.

b. Wrap entire ratchet assembly around tree and hook other "S" hook through opposite tree blade hole. Pull tail of long strap until most of the slack is taken out. Be sure entire strap is even and at the same level all around tree. "Ratchet" tight to tree, this will securely attach ladder to tree and prevent movement. **SEE FIGURES 16C.**

NOTE: Make sure there is at least two full revolutions of strap on the ratchet spool before the strap tightens. Proper tension will ensure the stand is secured to the tree. Do not allow excessive strap to build up in the ratchet as this will prevent the ratchet teeth from engaging and can cause slippage.

To release ratchet, simply pull the release lever and open tightening lever wide open (flat). SEE FIGURE 16D.

9. If necessary, re-check and adjust the 6' ratchet strap (27), 16' criss cross straps (26) and horizontal stabilizer bar assembly to securely attach the treestand to the tree. The tree blade must be touching the tree.
10. You are now ready to use your ladder stand.

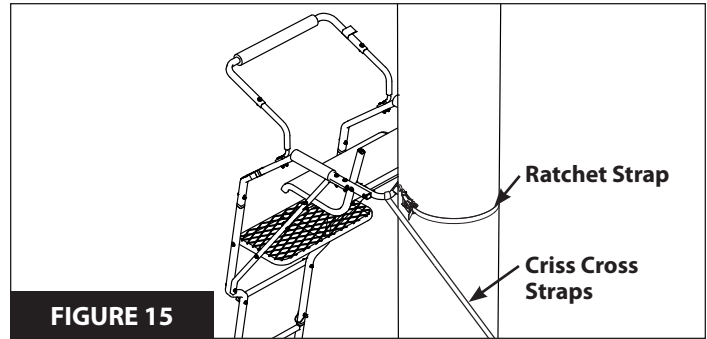

FIGURE 15

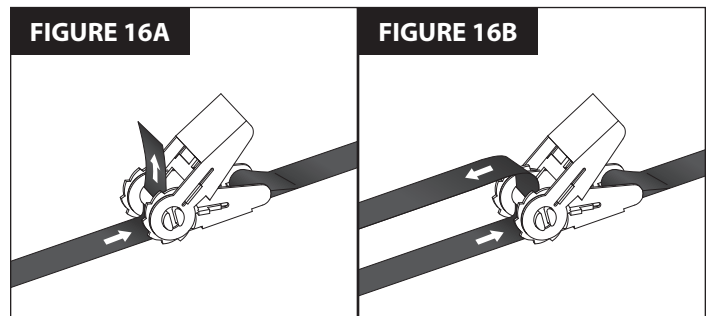

FIGURE 16A

FIGURE 16B

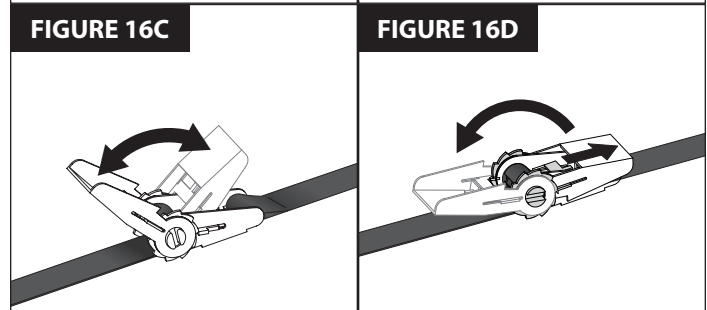

FIGURE 16C

FIGURE 16D



IMPORTANT

- ▲ Reverse the Set-Up and Use Instructions to take the ladder stand down.

FINISHED LADDER

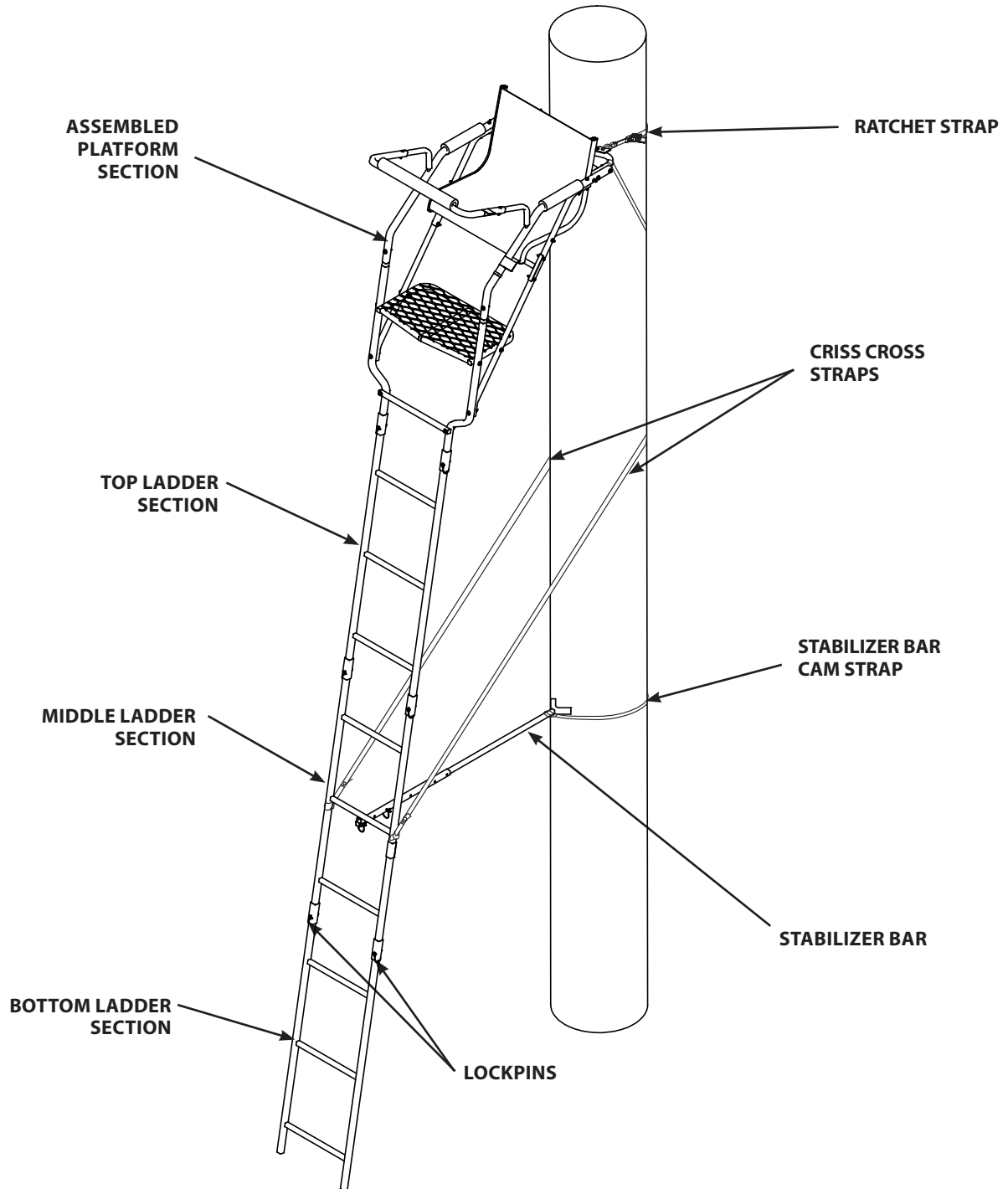

ILLUSTRATED PARTS BREAKDOWN

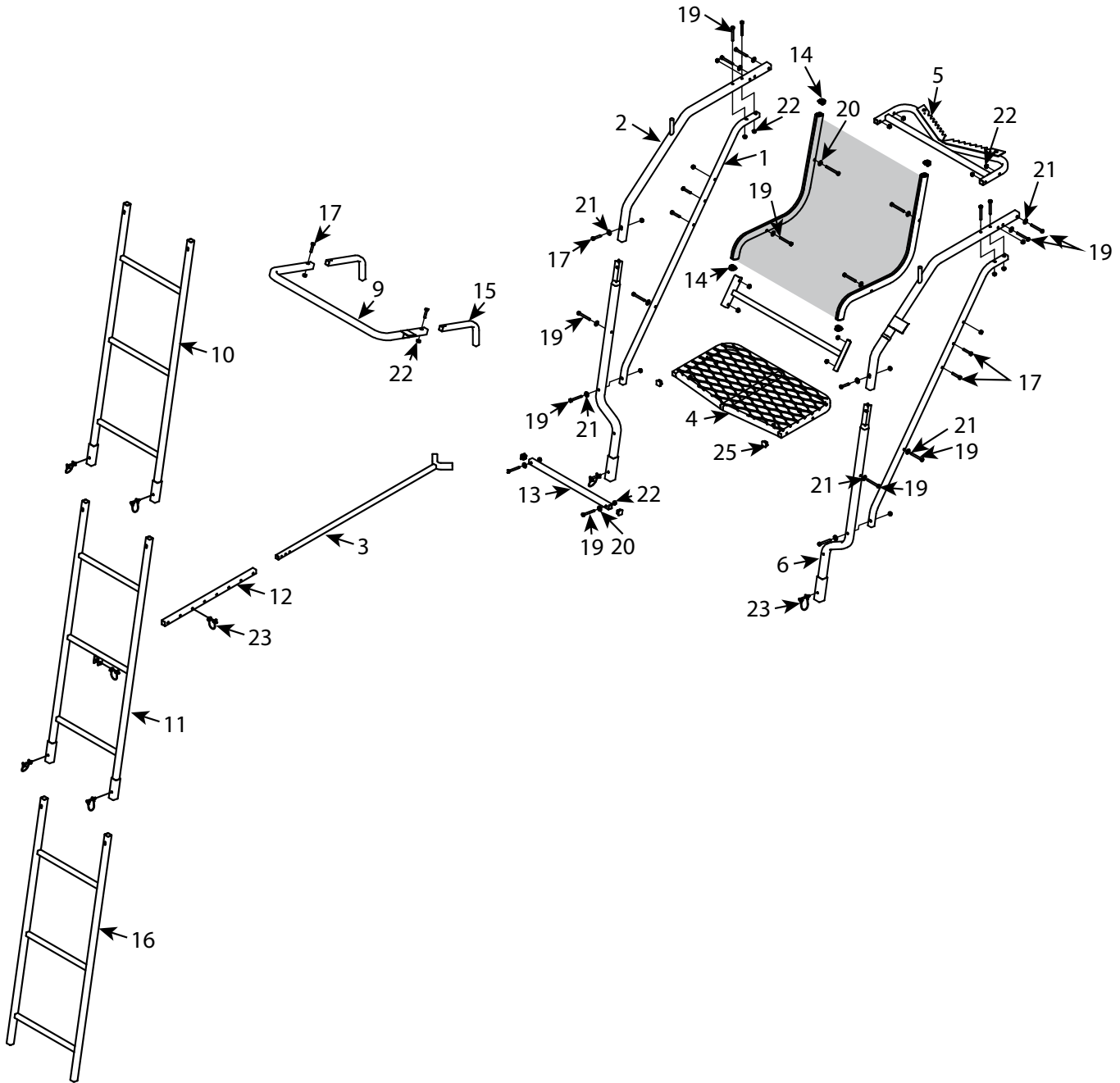

PARTS LIST

ITEM #	PART #	DESCRIPTION	QTY.
1	31873	BRACE UPPER LADDER SUPPORT	2
2	31938	LADDER SIDE RAIL	2
3	27397	STABILIZER BAR 39 IN	1
4	31805	PLATFORM	1
5	10373	TREE BLADE	1
6	31875	FLARED RAIL	2
7	31931	CROSS SUPPORT	2
8	32314	ASSEMBLY SEAT RELAX WIDE	1
9	10394	RIM SHOOTING RAIL	1
10	31737	TOP LADDER SECTION	1
11	31739	MIDDLE LADDER SECTION	1
12	1ML23	TUBE, STABILIZER, SUPPORT	1
13	410034	STEP LADDER 17 IN	1
14	23307	SEAT CHANNEL PLASTIC CAP	4
15	410113	FTS J PIPE SHOOTING RAIL	2
16	31740	BOTTOM LADDER SECTION	1

**NO EXTENSIONS AVAILABLE FOR THIS MODEL.
NEVER MODIFY OR EXCEED ORIGINAL STATED USE HEIGHT!**

ITEM #	PART #	DESCRIPTION	QTY.
17	48240B	BOLT 1/4-20 X 1 1/2 IN	6
18	8909B	BOLT 1/4-20 X 1-1/4 IN	2
19	48271B	BOLT 1/4-20 X 2-1/4 IN	20
20	48261B	WASHER 1/4 X 5/8 X 0.07 IN	6
21	23572	YELLOW WASHER YELLOW 6.5 X 19.0 X 2.0 MM	12
22	48752B	FLANGE LOCKNUT 1/4-20 IN	28
23	19847	LOCKPIN 6 MM X 50.8 MM	8
24	48270B	BOLT 1/4-20 X 2-1/2 IN	2
25	29713	PLUG 19 MM TUBING	4
ITEMS BELOW ARE NOT SHOWN			
26	MK034-4511	CRISS CROSS STRAP 3/4 IN X 16 FT ASSEMBLY	2
27	48415	RATCHET STRAP	1
28	40697	FALL ARREST SYSTEM (FAS)	1
29	48736	SLEEVE W/FOAM 9"	2
30	48737	SLEEVE W/FOAM 18"	1
31	MK021-1401	CAM STRAP W/LOOPS 1 IN X 6 FT ASSEMBLY	1

OTHER GREAT PRODUCTS BY RIVERS EDGE TREESTANDS**LANDMARK™**
PERMANENT BLINDS

Portable ground blinds take a beating from the sun, wind, rain and snow. Colors fade, materials rot, poles break and fabric tears. The Landmark Permanent Blind was designed and constructed to resist the elements year after year. The durable steel frame is covered in marine-grade reinforced synthetic tarpaulin, made from the same rugged materials used in pick-up truck tonneau covers. The window configuration allows you to precisely control gap vertically, horizontally or both. If you're looking for an affordable year-round hunting blind with enough room for group hunts and archers, the Landmark Permanent Blind is for you.

Big Foot™ CLIMBING AIDS

All climbing aids are not created equal. For starters, Bigfoot Climbing Aids feature extra-large rungs that a hunter can place 2 feet on the same level. Next we use a permanent anti-slip coating called Tractionite. Our assortment of climbing aids securely attach to the tree using cam straps or ratchet straps. We take immense pride and satisfaction in knowing that our designs consistently gain praise from hunters and outfitters who recognize the little differences. A big hunt should never be ruined over a little climb!

Big Foot™ HANG-ONS

Nothing attaches to a tree tighter than a Big Foot™ Treestand! Our line of lever-action hang-on stands bite into the tree eliminating the need for a second strap. Other treestands use small ratchet straps that are not as secure once installed. Perfect for sitting on a tree at ground level or higher up when paired with our climbing aids. Feel the stability of a Big Foot™ Treestand for yourself!



WE ARE HUNTERS

Rivers Edge® Treestands, Inc.

1730 Industrial Avenue, PO Box 755
Cumberland, WI 54829

Phone: 800-345-6007

Fax: 715-822-2124

www.HuntRiversEdge.com

*All weights, specifications and features are approximate and are subject to change without notice. Due to continuous product improvements, product images may not be exact. Warning labels in some product images may have been removed for photography purposes only. Props shown in photos not included. Some assembly may be required.
