

ready to assemble -- tools required:
electric drill with phillips bit and/or a phillips screwdriver, small pair of pliers

item #15059
overall dimensions
81.875" L X 47.75" W X 37.75" H
208 cm x 121 cm x 96 cm

**rustic barn
assembly instructions**
warepet.com

Thank you for your purchase. Follow these detailed instructions to properly assemble your new **rustic barn coop**. To ensure assembly success, please read all care guides carefully prior to assembly and installation.

warnings & cautions









- Coop should be placed on a flat level surface for stability.
- Keep small parts away from pets/children to avoid choking hazard.
- Follow instructions in this manual to avoid personal injury to pet or property damage.
- This coop is for chicken use only, it is not suitable for children or other animals.
- Keep all tools and instructions in a safe place for future reference.
- Always supervise your flock when using this item. Inspect product regularly and re-tighten screws as needed.
- For additional stability, coop can be anchored to the ground.









warepet.com

If you have any questions or concerns about this product contact our customer service department at 1-800-295-2243 Mon-Fri 8:00 - 4:00 MST or email us at hello@warepet.com







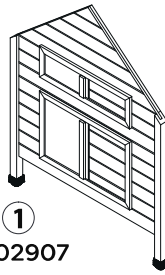
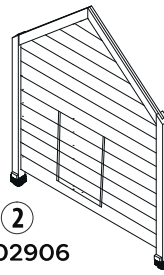
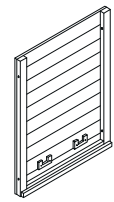
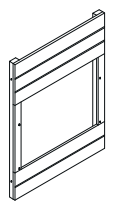

Due to ongoing product improvements, product photo on packaging may not match finished product.

HARDWARE

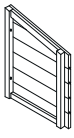
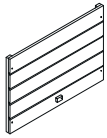
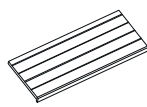
 A		1- ³ / ₈ " (3.5 x 35mm)	14pcs	#902915
 B		1" (3.5 x 25mm)	4pcs	#902914
 C		1/2" (3.0 x 14mm)	4pcs	#902913
 D		3/4" (3.0 x 20mm)	3pcs	#902912

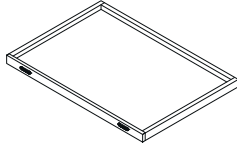
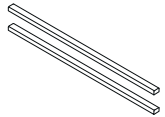
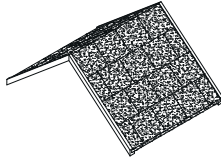
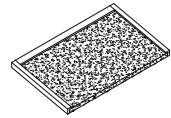
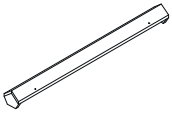
 E		1- ⁵ / ₈ " (3.5 x 40mm)	20pcs	#902911
 F		2- ³ / ₈ " (3.5 x 60mm)	4pcs	#902910
 G		3" (M6 x 80mm)	8pcs	#902909
 H		2- ¹ / ₂ " (M6 x 65mm)	4pcs	#902908

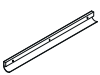
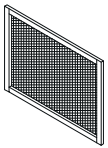
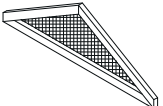
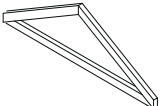
PARTS

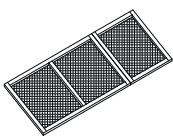
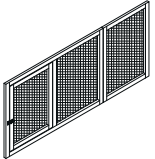
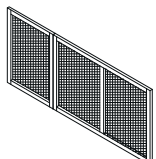
 ① #902907	 ② #902906	 ③ #902905	 ④ #902904
 ⑤ #902903	 ⑥ #902902	 ⑦ #902901	 ⑧ #902900
 ⑨ #902899	 ⑩ #902884	 ⑪ #902885	 ⑫ #902886
 ⑬ #902887	 ⑭ #902888	 ⑮ #902889	 ⑯ #902890
 ⑰ #902891	 ⑱ #902892	 ⑲ #902893	 ⑳ #902894
 ㉑ #902895	 ㉒ #902896	 ㉓ #902897	 ㉔ #902898

warepet.com

If you have any questions or concerns about this product contact our customer service department at 1-800-295-2243 Mon-Fri 8:00 - 4:00 MST or email us at hello@warepet.com

Due to ongoing product improvements, product photo on packaging may not match finished product.

STEP 1

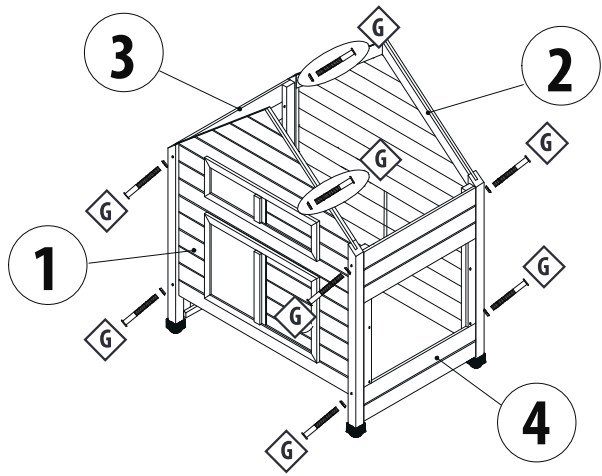

G  (M6 x 80mm) 8pcs

STEP 2

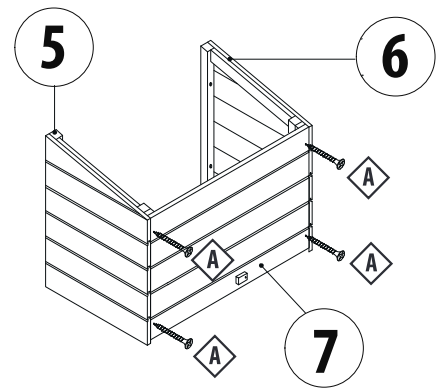

A  1-3/8" (3.5 x 35mm) 4pcs

STEP 3

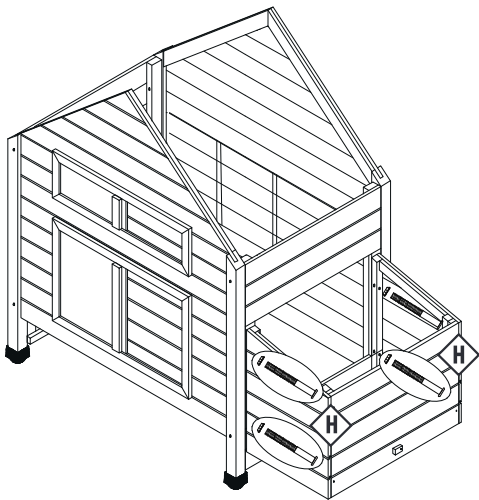



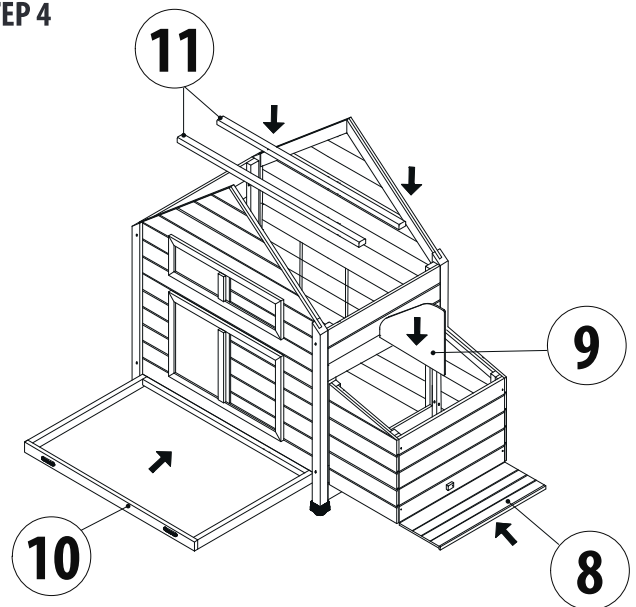

H  2-1/2" (M6 x 65mm) 4pcs

STEP 4

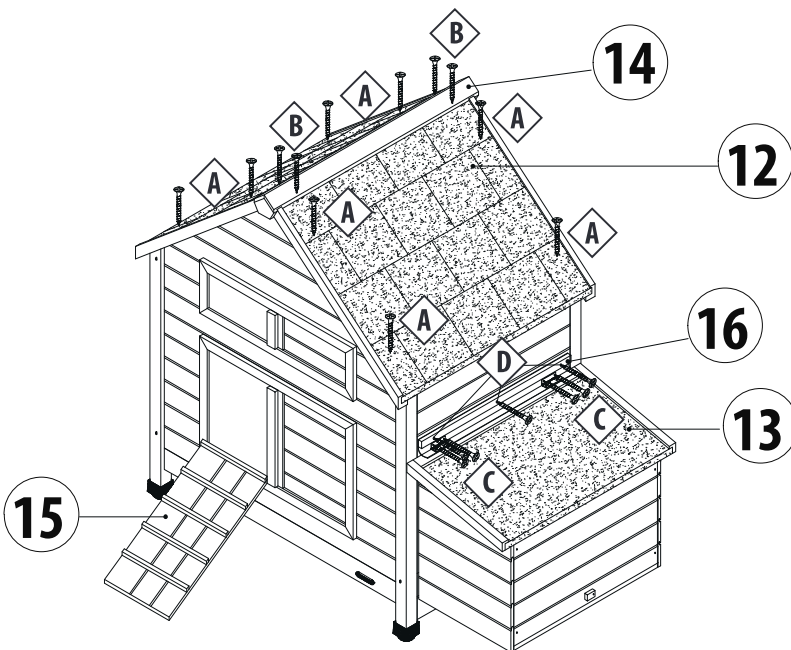





STEP 5



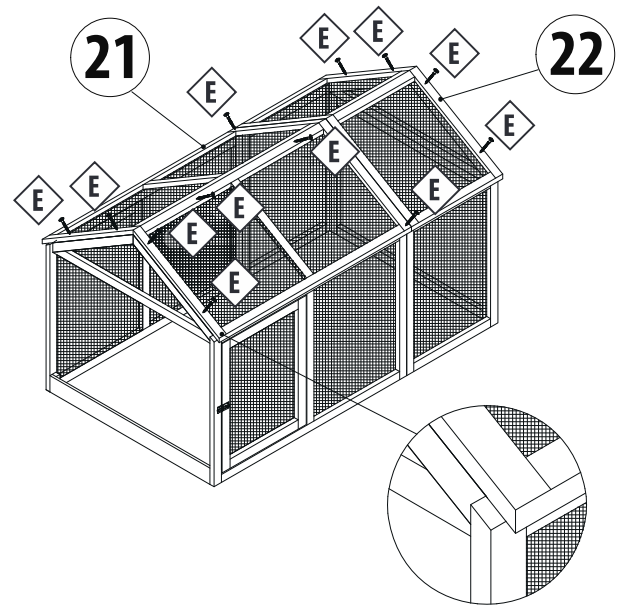
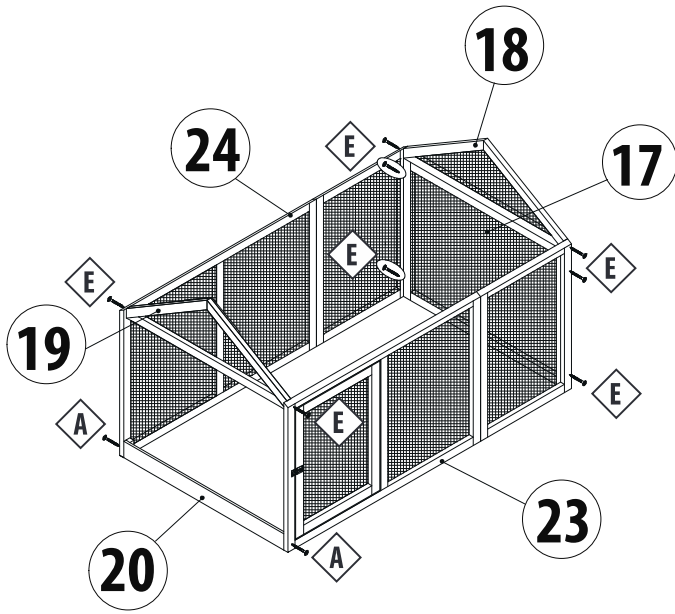

A  1-3/8" (3.5 x 35mm) 8pcs
B  1" (3.5 x 25mm) 4pcs
C  1/2" (3.0 x 14mm) 4pcs
D  3/4" (3.0 x 20mm) 3pcs



STEP 7

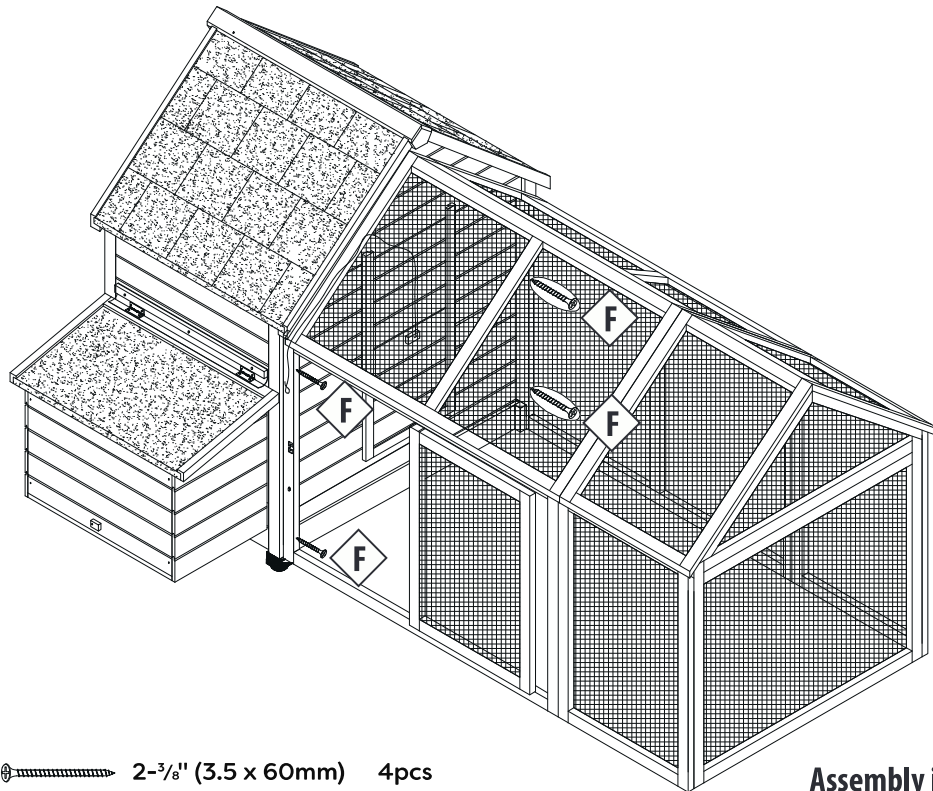

-   1-3/8" (3.5 x 35mm) 2pcs
-   1-5/8" (3.5 x 40mm) 8pcs

-   1-5/8" (3.5 x 40mm) 12pcs



-   2-3/8" (3.5 x 60mm) 4pcs

Assembly is now complete

care tip

To protect the wood on your pen you need to re-apply the protective stain finish at least 1x each year. Use a safe and non-toxic water based stain (available at your local paint or hardware center). Keep pen in a safe area away from high winds and extreme temperatures.