

ready to assemble -- tools required:
electric drill with phillips bit and/or a phillips screwdriver, small pair of pliers

item #15058
overall dimensions
78.75" L X 37.4" W X 47.25" H
200 cm x 95 cm x 120 cm

**rustic ranch
assembly instructions**
warepet.com

Thank you for your purchase. Follow these detailed instructions to properly assemble your new **rustic ranch coop**. To ensure assembly success, please read all care guides carefully prior to assembly and installation.

warnings & cautions



- Coop should be placed on a flat level surface for stability.
- Keep small parts away from pets/children to avoid choking hazard.
- Follow instructions in this manual to avoid personal injury to pet or property damage.
- This coop is for chicken use only, it is not suitable for children or other animals.
- Keep all tools and instructions in a safe place for future reference.
- Always supervise your flock when using this item. Inspect product regularly and re-tighten screws as needed.
- For additional stability, coop can be anchored to the ground.



warepet.com

If you have any questions or concerns about this product contact our customer service department at 1-800-295-2243 Mon-Fri 8:00 - 4:00 MST or email us at hello@warepet.com



Due to ongoing product improvements, product photo on packaging may not match finished product.

HARDWARE

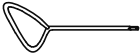
- A**  (M6 x 50mm) 8pcs #902811
- B**  (M6 x 40mm) 22pcs #902812
- C**  1-3/8" (3.5 x 35mm) 6pcs #902813

- D**  1-3/16" (3.5 x 30mm) 16pcs #902814
- E**  1" (3.5 x 25mm) 8pcs #902815
- F**  1/2" (3.0 x 16mm) 4pcs #902816
- G**  1 pc #902817

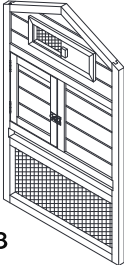
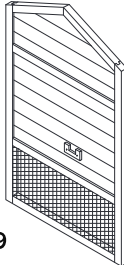
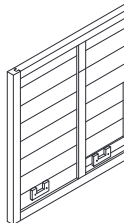
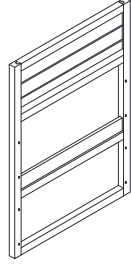
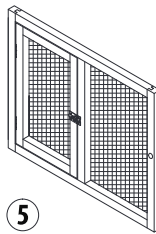
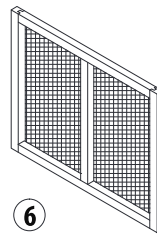
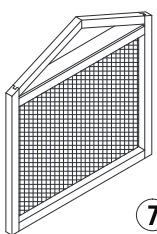
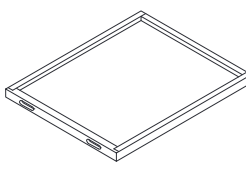
PARTS

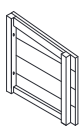
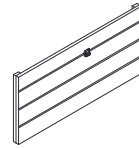
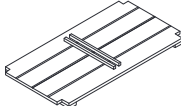
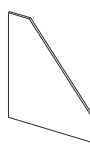
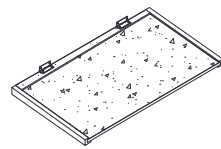
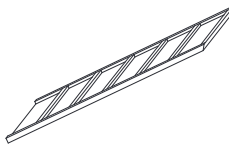
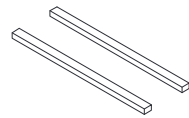
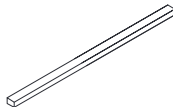
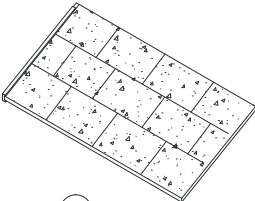
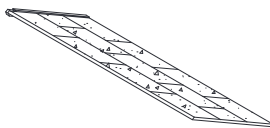
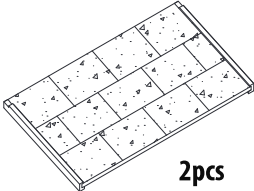
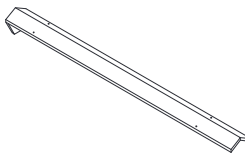
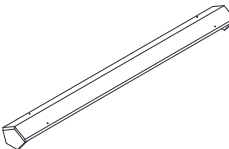
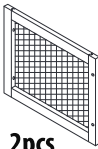
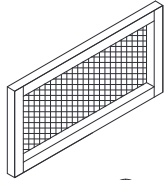
 1 #902818	 2 #902819	 3 #902820	 4 #902821
 5 #902822	 6 #902823	 7 #902824	 8 #902825
 9 #902826	 10 #902827	 11 #902828	 12 #902829
 13 #902830	 14 #902831	 15 #902832	 16 #902833
 17 #902834	 18 #902835	 19 #902836	 20 #902837
 21 #902838	 22 #902839	 23 #902840	 24 #902841

warepet.com

If you have any questions or concerns about this product contact our customer service department at 1-800-295-2243 Mon-Fri 8:00 - 4:00 MST or email us at hello@warepet.com

Due to ongoing product improvements, product photo on packaging may not match finished product.

STEP 1

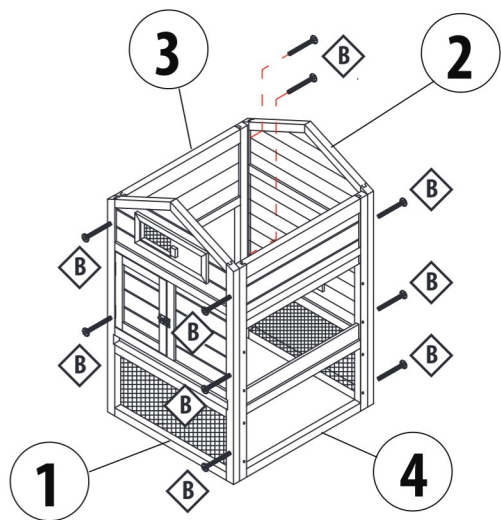

B (M6 x 40mm) 10pcs

STEP 2

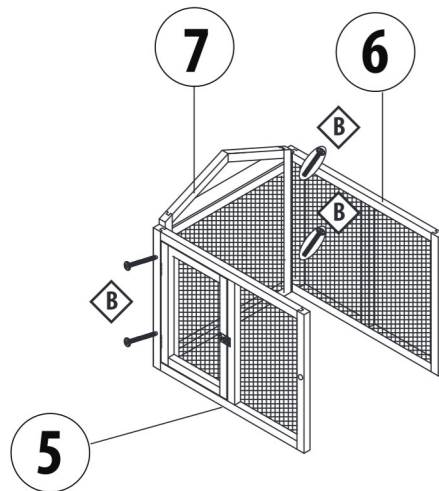

B (M6 x 40mm) 4pcs

STEP 3

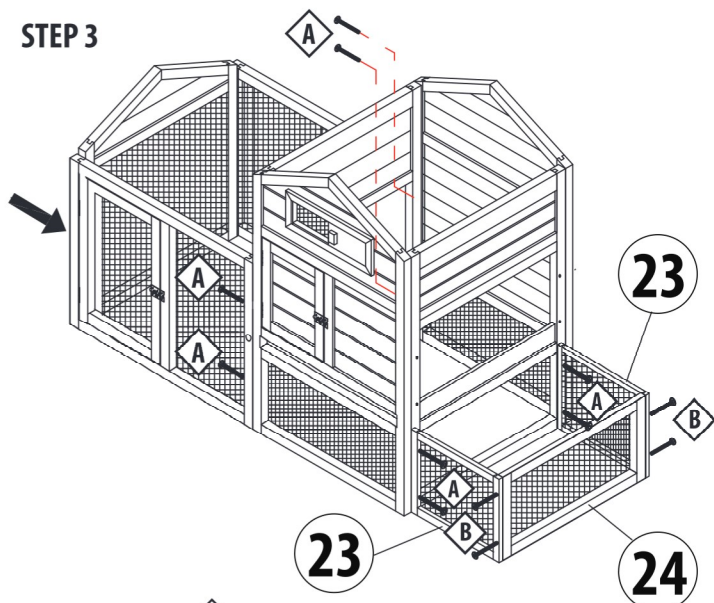

A (M6 x 50mm) 8pcs

B (M6 x 40mm) 4pcs

STEP 4

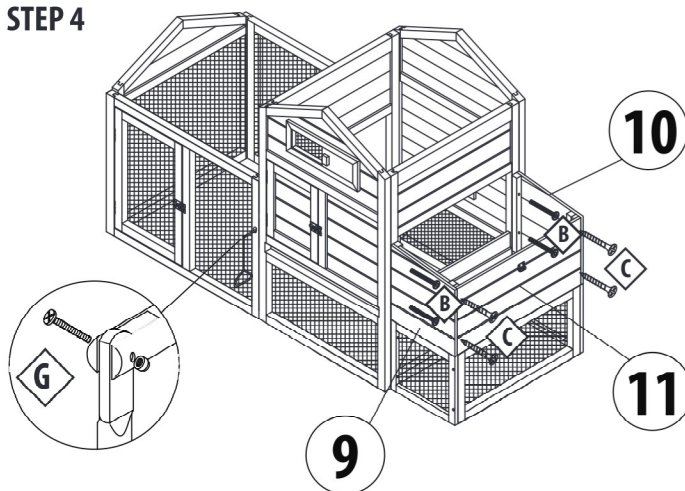

B (M6 x 40mm) 4pcs

C 1-3/8" (3.5 x 35mm) 4pcs

G 1 pc

STEP 5

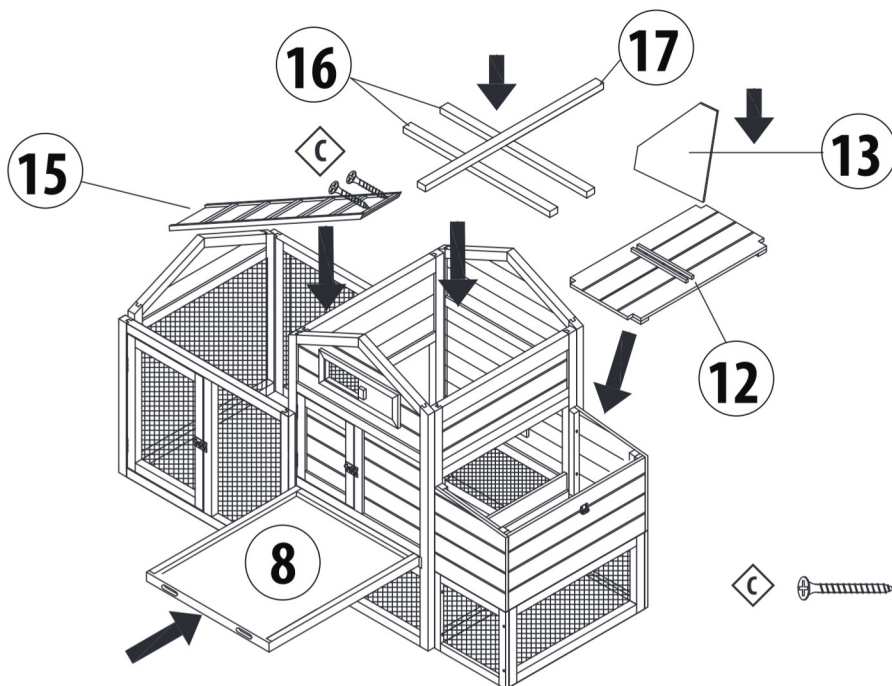

C 1-3/8" (3.5 x 35mm) 2pcs

STEP 7

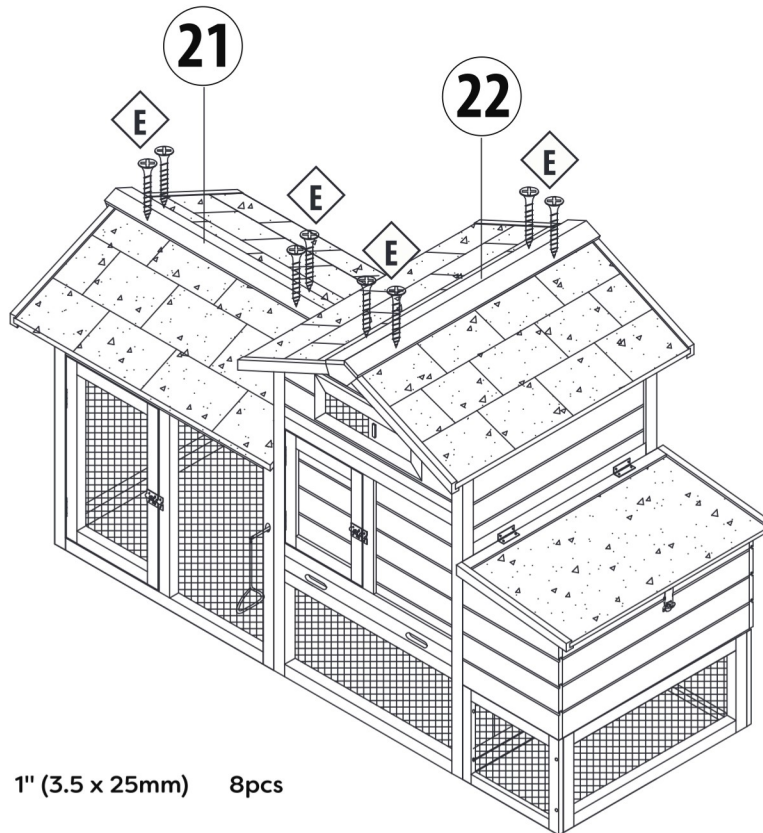
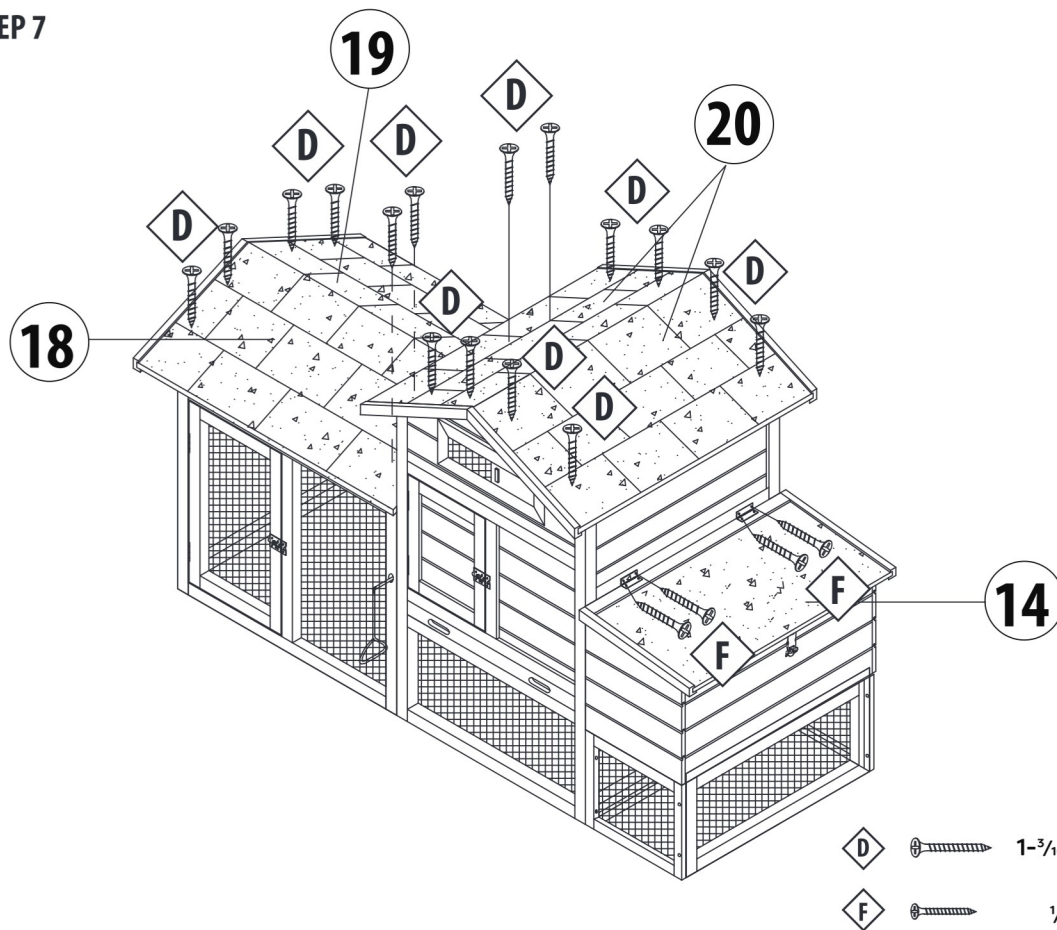

Assembly is now complete

care tip

To protect the wood on your pen you need to re-apply the protective stain finish at least 1x each year. Use a safe and non-toxic water based stain (available at your local paint or hardware center). Keep pen in a safe area away from high winds and extreme temperatures.