

ASSEMBLY INSTRUCTION

DDP-1843

(A)  3.5x40=64x

PARTS

1x4

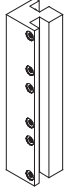

2x6



3x6

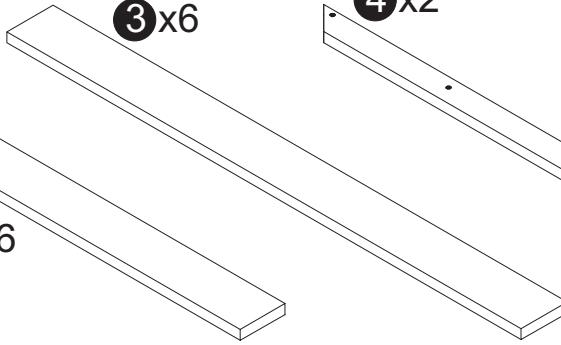

4x2

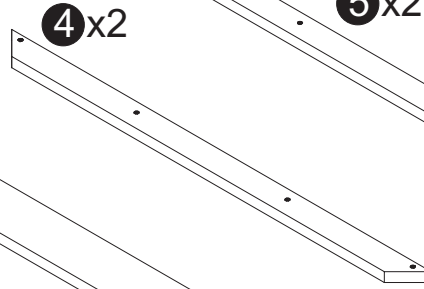

5x2

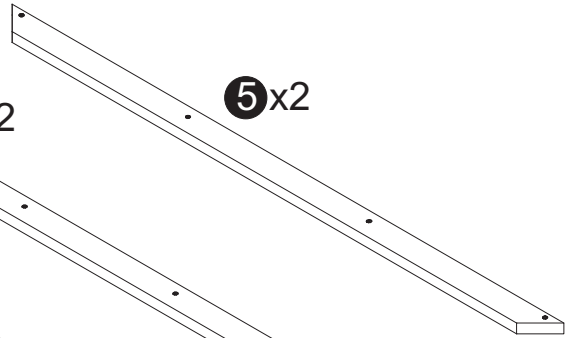

ASSEMBLY

1

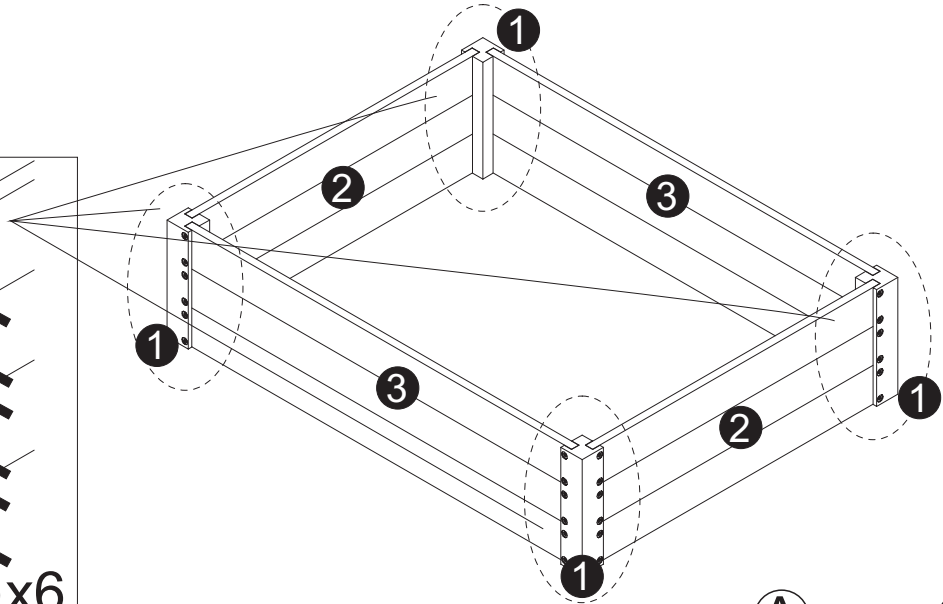
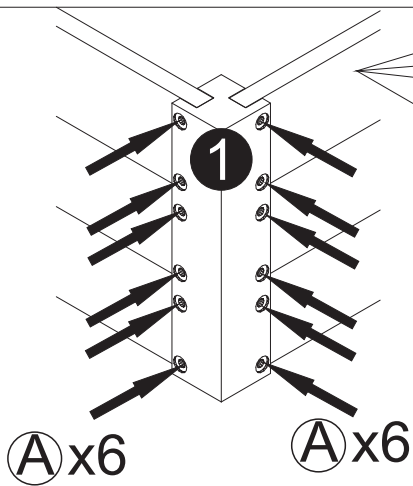

2

